

**OPENMOVE** **S661**

User Guide

# Contents

## HOW IT WORKS

Headphone Controls .....	04
ON/OFF .....	05
Pairing .....	06
How to Wear .....	07
Volume .....	08
Multifunction Button .....	09
Check Battery Status .....	11

## EXTRA FEATURES

EQ Modes .....	13
Switching EQ modes .....	14
Multipoint Pairing .....	15
Turn Multipoint Pairing Off .....	21
Restore Factory Settings .....	23
Changing languages .....	25

## CARE AND MAINTENANCE

Charging Tips .....	28
Storage and Maintenance .....	29
Warranty .....	30

**TROUBLESHOOTING** ..... 31

**WHAT'S IN THE BOX** ..... 32

**REGULATORY AND LEGAL INFORMATION**  
..... 33

---

# How It Works

# Headphone Controls

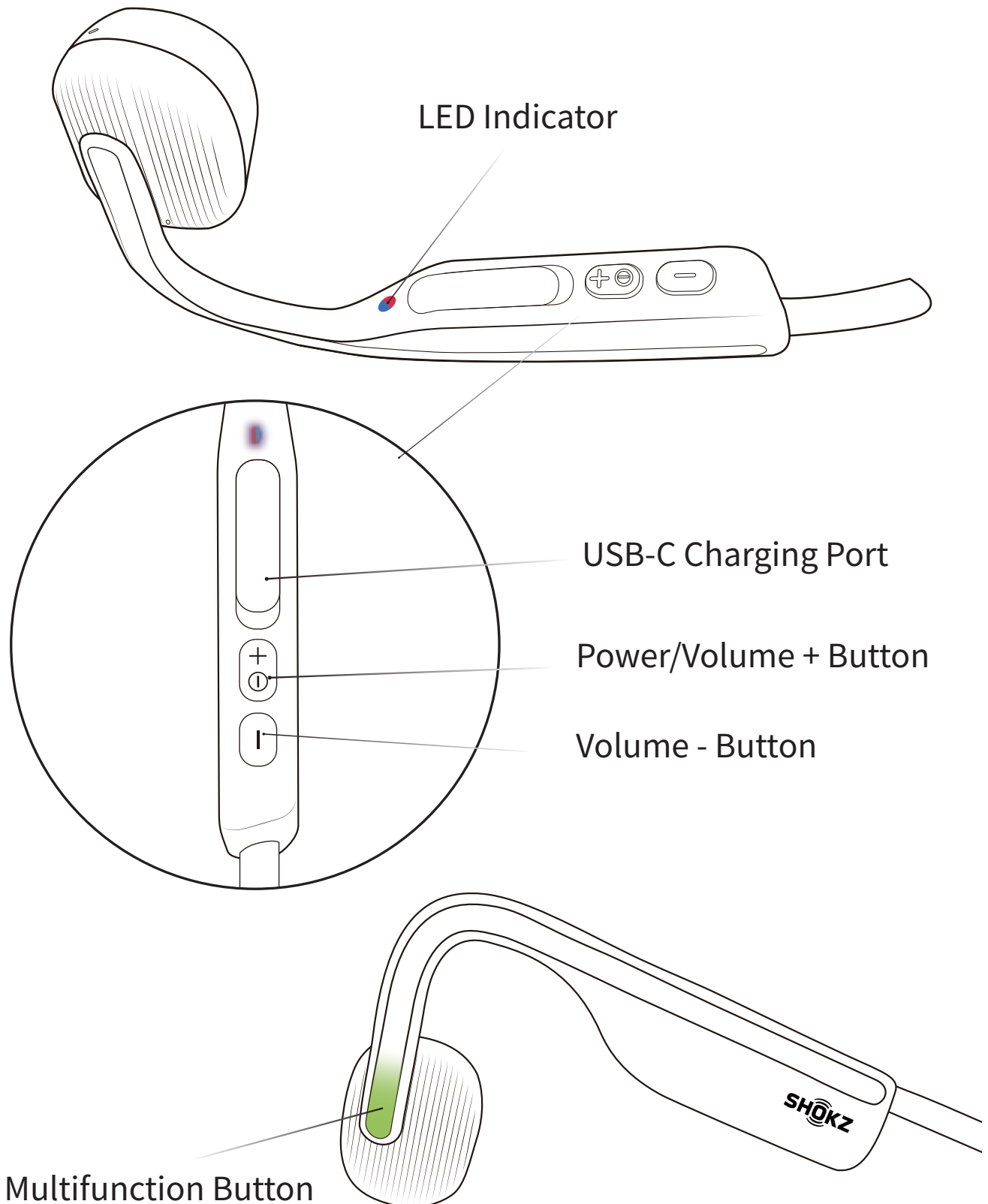

# ON/OFF

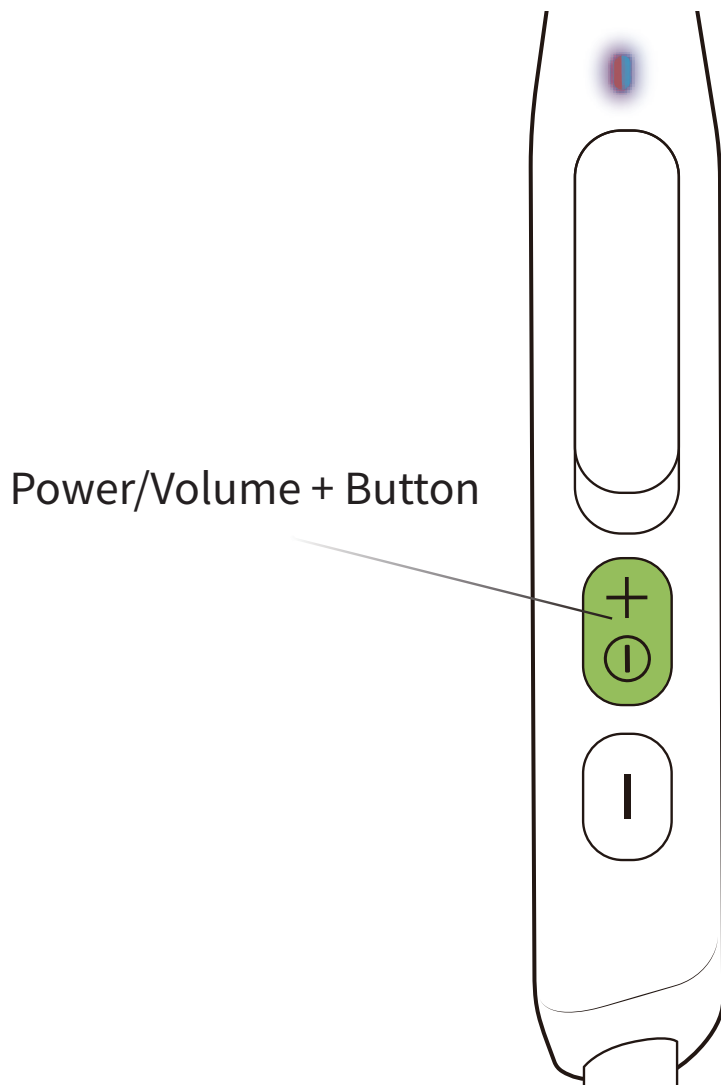

## Turn on the headphones:

Press and hold the Power/Volume + Button until the LED Indicator flashes blue.

\*Audrey will say: “Welcome to Shokz”

## Turn off the headphones:

Press and hold the Power/Volume + Button until the LED Indicator flashes red.

\*Audrey will say: “Power off”

# Pairing

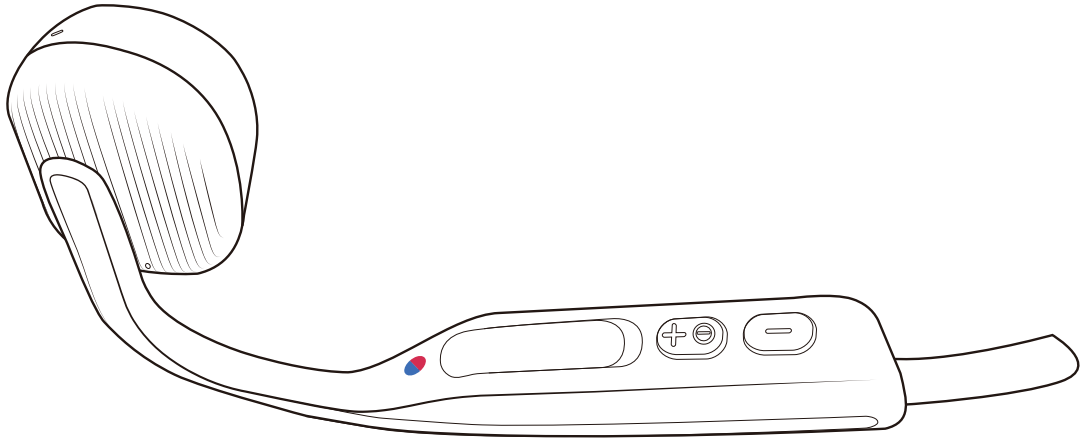

1. Start with OpenMove turned off.
2. Press and hold the Volume + Button until the LED Indicator flashes red and blue alternately.

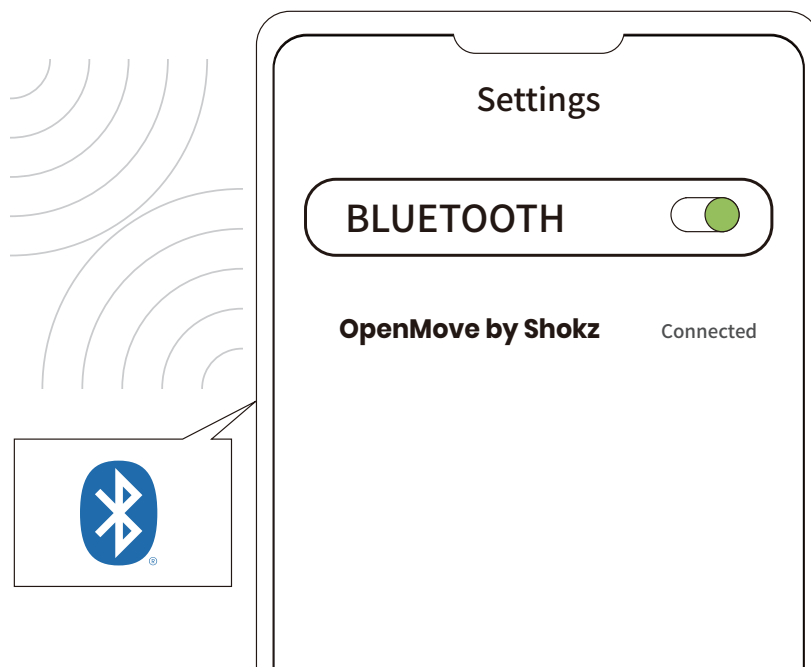

3. Open your device's Bluetooth settings and select " OpenMove by Shokz." Audrey will say "connected."

# How to Wear

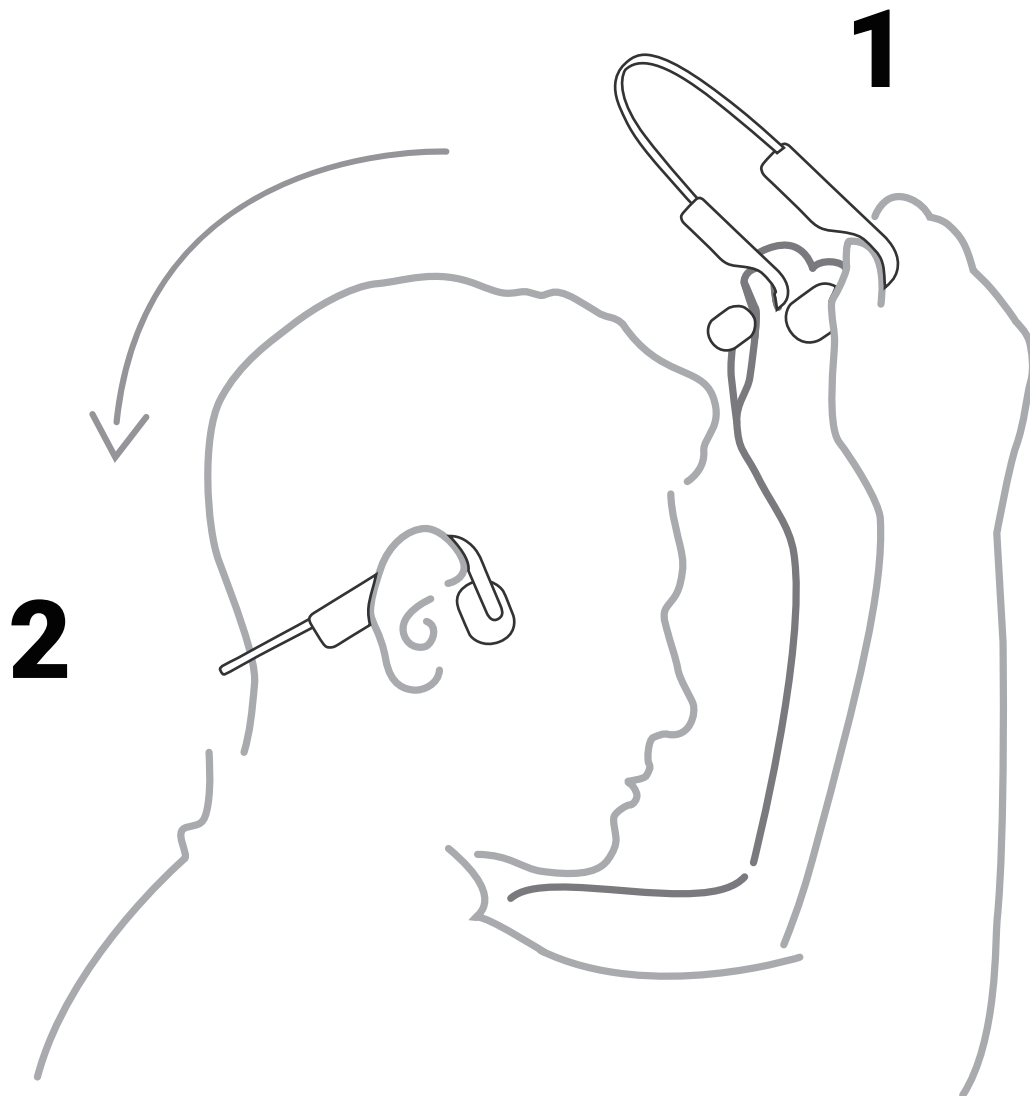

**Pick up the headphones, bring them behind the back of the base of your neck, position the earhooks on your ears, then enjoy your music!**

\*Wearing your headphones the wrong way could cause discomfort. The transducers should rest in front of your ears.



# Volume



Operate volume controls while audio is playing.

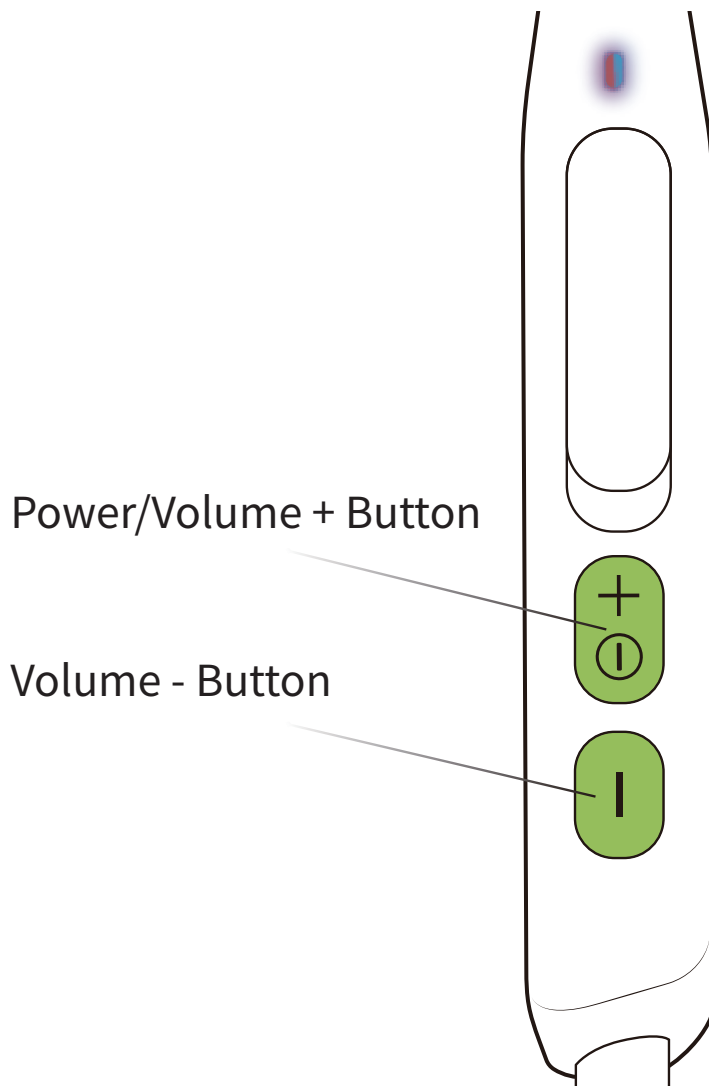

## How to change volume:

While your audio is playing, adjust headphone volume by pushing either the Volume + or Volume - buttons.

\*A “beep” will sound when the volume is at its max.



\*Listening with headphones at high volume may affect your hearing and the audio will be distorted.

# Multifunction Button

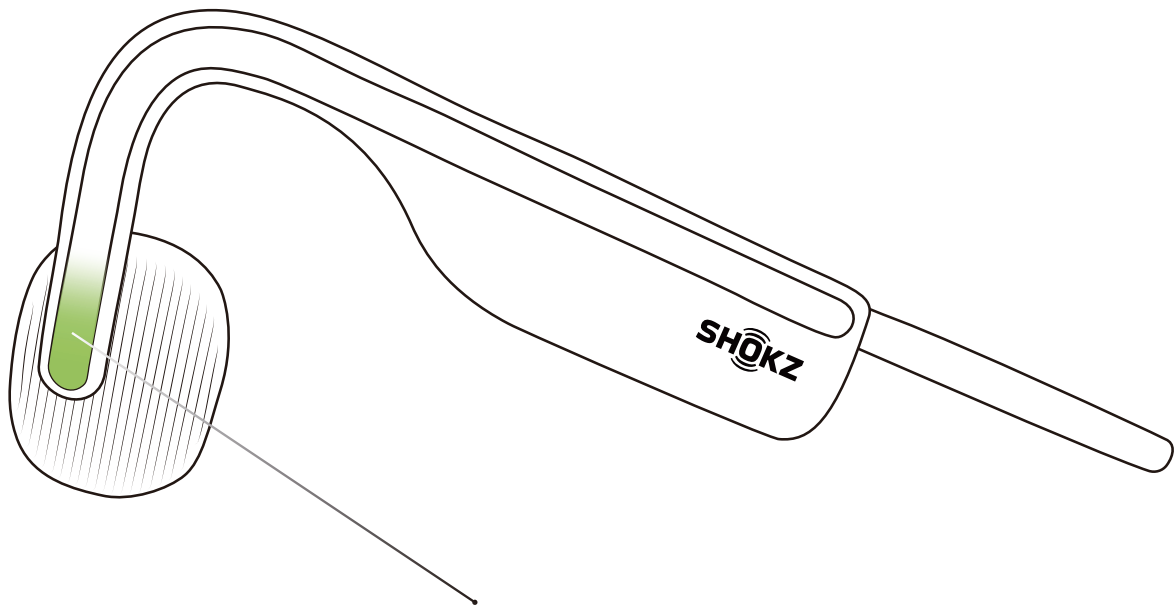

Multifunction Button

▶|| **Play/pause music** ●

Click once

☎ **Answer call** ●

Click once

⏭ **Next song** ● ●

Double-click while music is playing

📞 **End call** ●

Click once

⏮ **Previous song** ● ● ●

Triple-click while music is playing

# Multifunction Button

Play music	Click once
Pause music	Click once
Next song	Double-click while music is playing
Previous song	Triple-click while music is playing
Switch language	Double-click while on pairing
Answer call	Click once
End call	Click once during a call
Answer call waiting and end current call	Press and hold for 2 seconds when receiving a second call
Ignore a call	Press and hold for 2 seconds during an incoming call
Activate voice assistant	Press and hold for 2 seconds when device is on standby
Redial last number	Double-click on standby

\*Only applicable for phone calls, not online calls

# Check Battery Status



Operate controls while audio is not playing

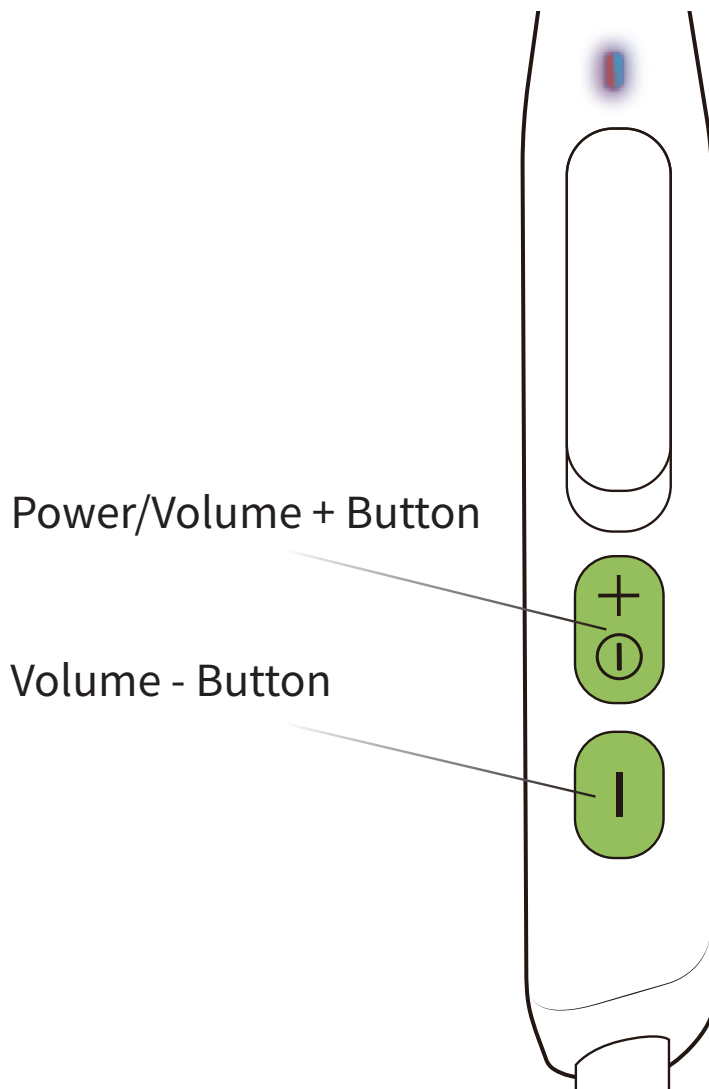

## How to check battery status:

Click the Volume + or Volume - button while music is paused, Audrey will tell you the battery status:

\* "Battery high/Battery medium/Battery low/Charge me"

---

# Extra Features

# EQ Modes



## **Standard Mode:**

Balanced frequency for listening to music



## **Vocal Booster Mode:**

Enhanced intermediate frequencies  
for audiobooks, podcasts, etc.

# Switching EQ Modes



Operate controls while music is playing

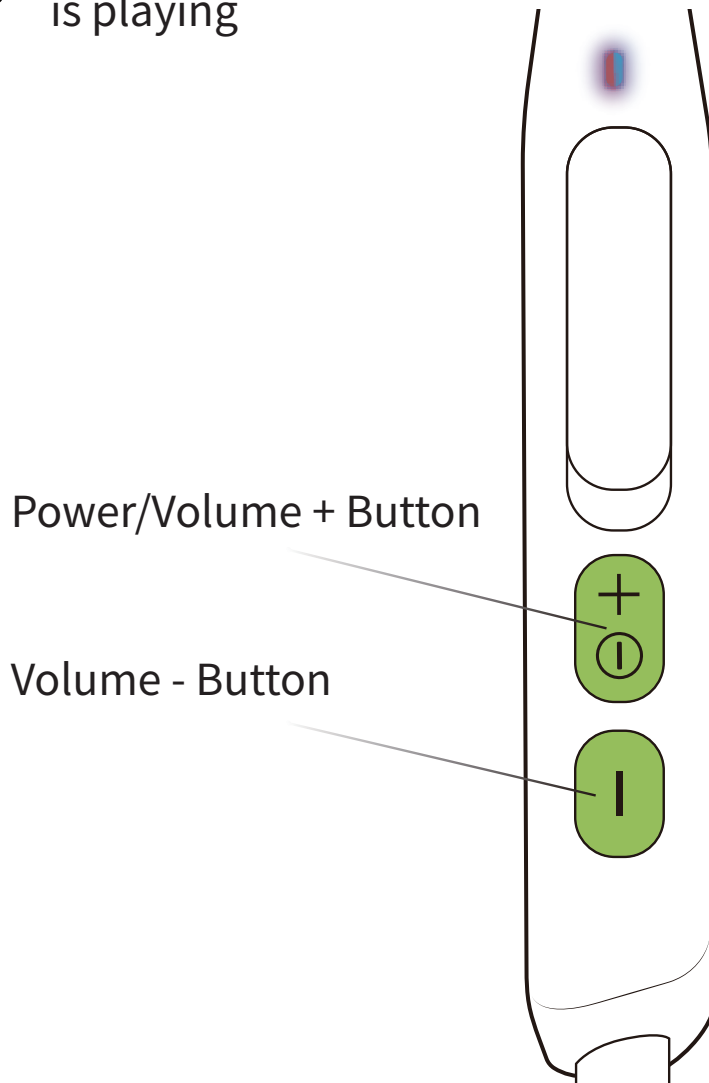

## How to switch EQ mode:

Press and hold both buttons (Power/Volume + Button and Volume - Button) while music is playing until you hear a beep.

\*Audrey will say: “Standard Mode/Vocal Booster Mode.”

# Multipoint Pairing

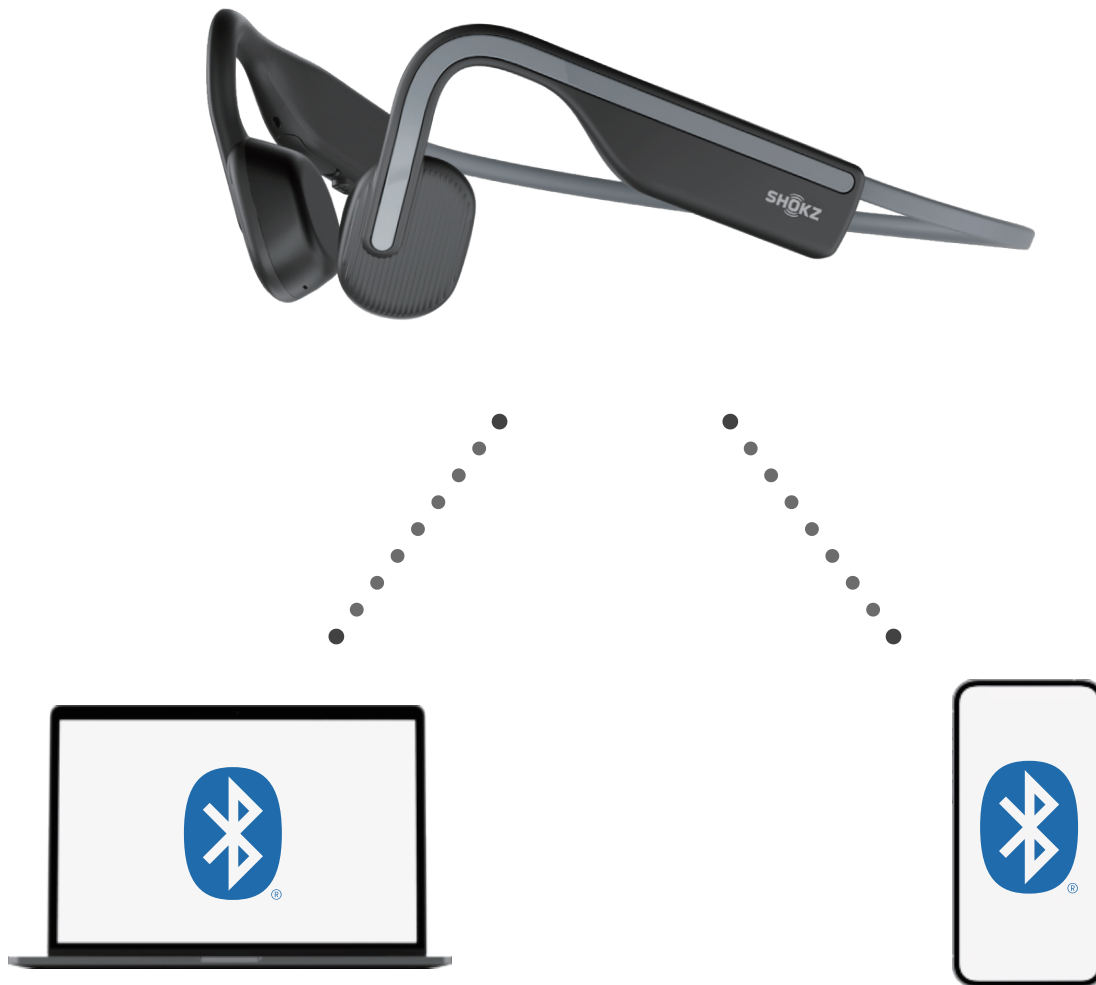

## Pair Two Devices

Switch between two devices seamlessly with multipoint pairing



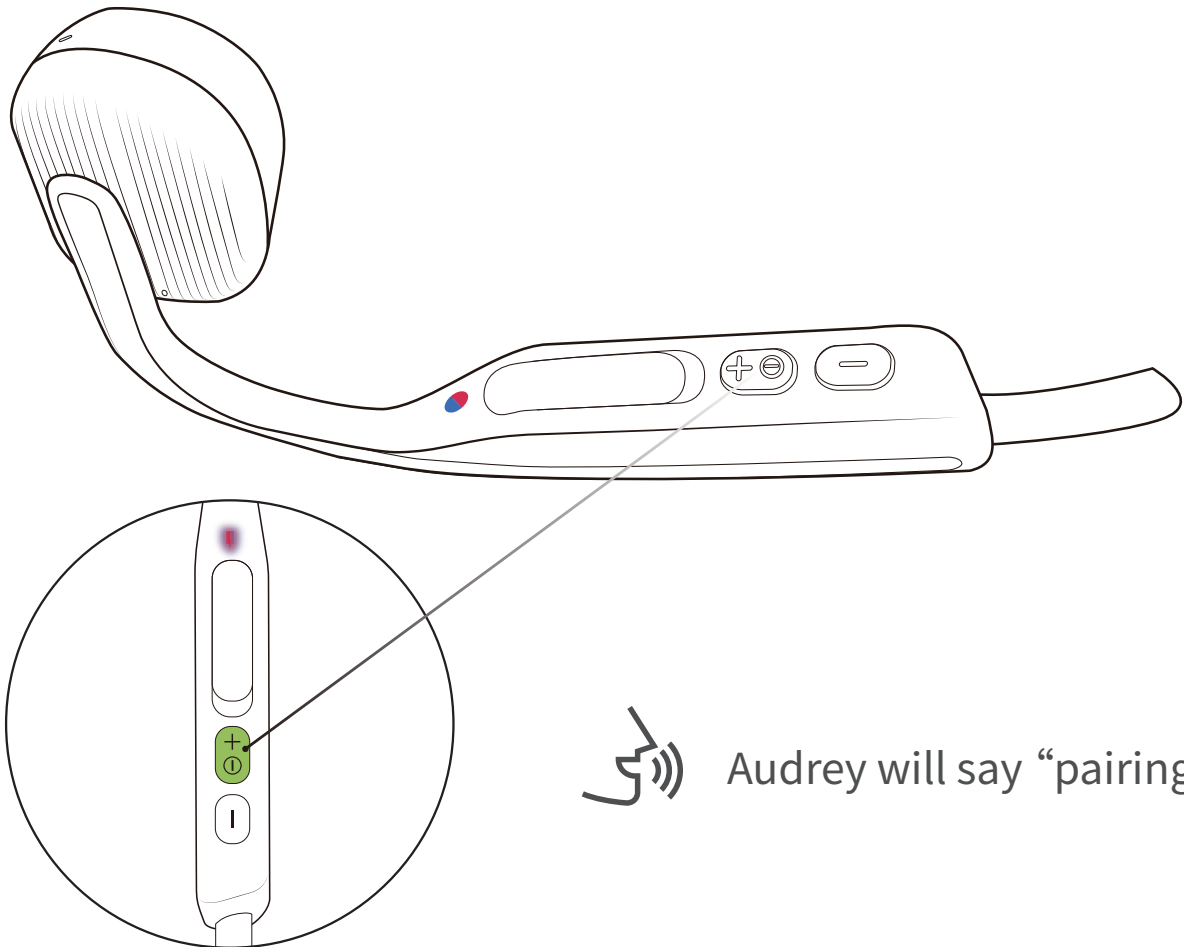

# Multipoint Pairing

**OFF** Operate controls with  
headphones powered off

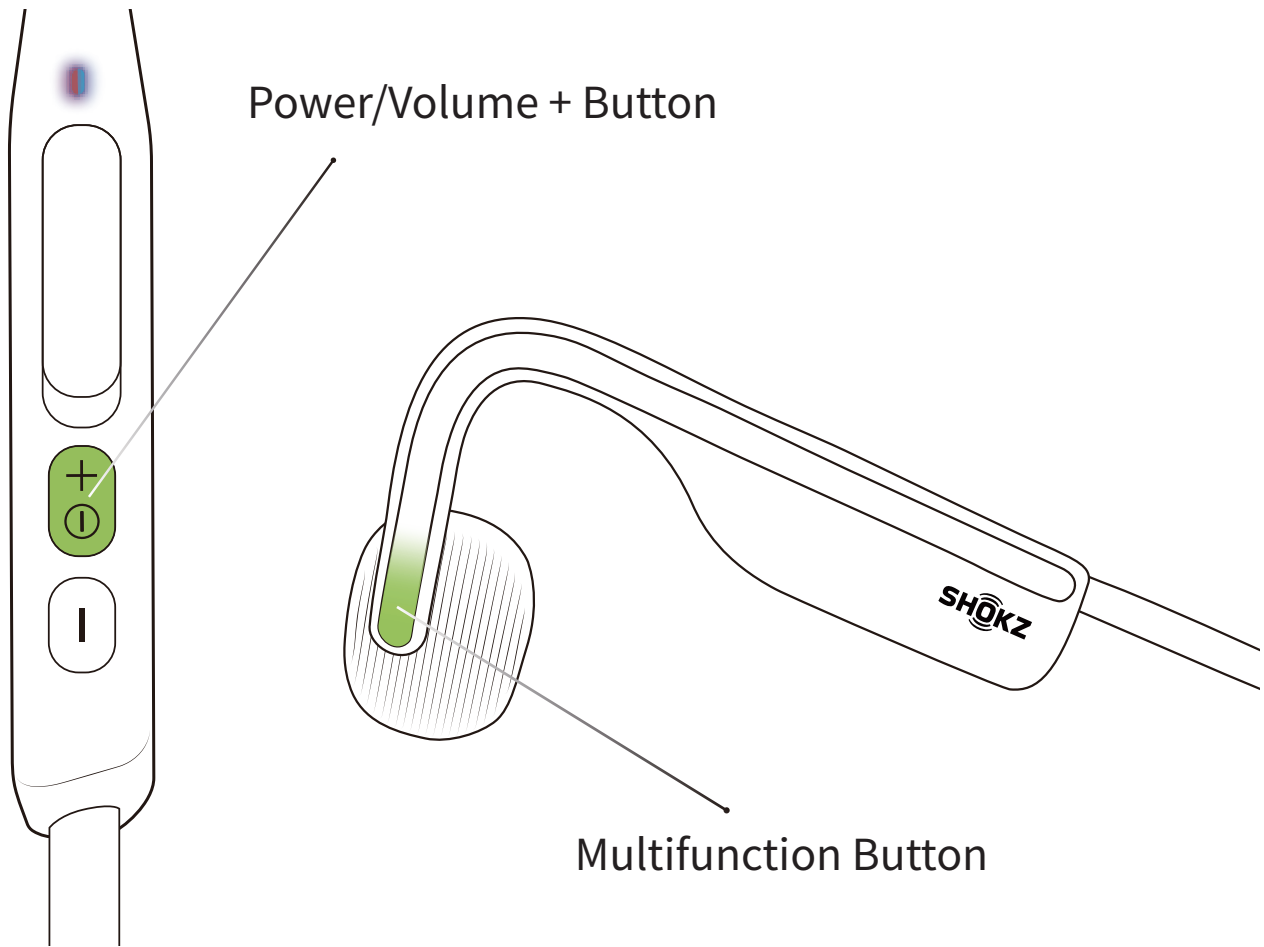

1. Start with your headphones powered off.
2. Press and hold Volume + until Audrey will say “pairing” and the LED indicator flashes red and blue alternately.



 Audrey will say "multipoint enabled."

3. Press and hold the multifunction button and Volume + button until Audrey say "multipoint enabled."

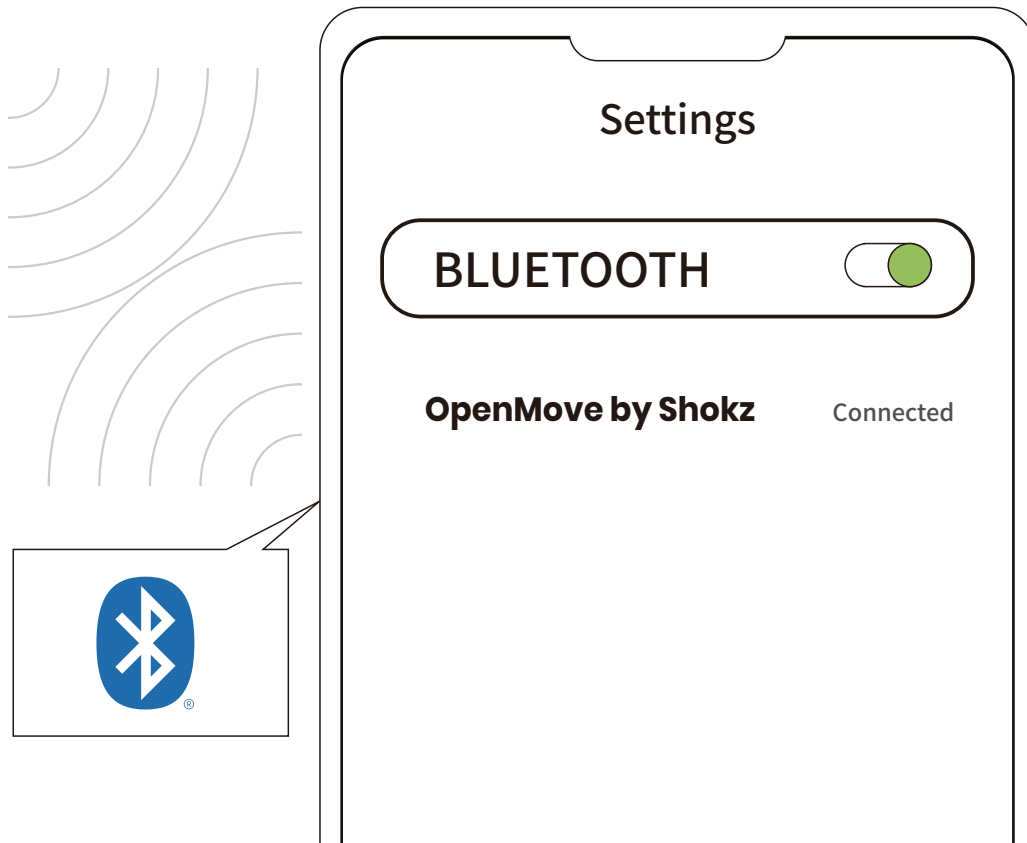

## First Device



Audrey will say "connected".

4. Open first device's Bluetooth® menu and select "OpenMove by Shokz." Audrey will say "connected".

5. Turn your headphones off.

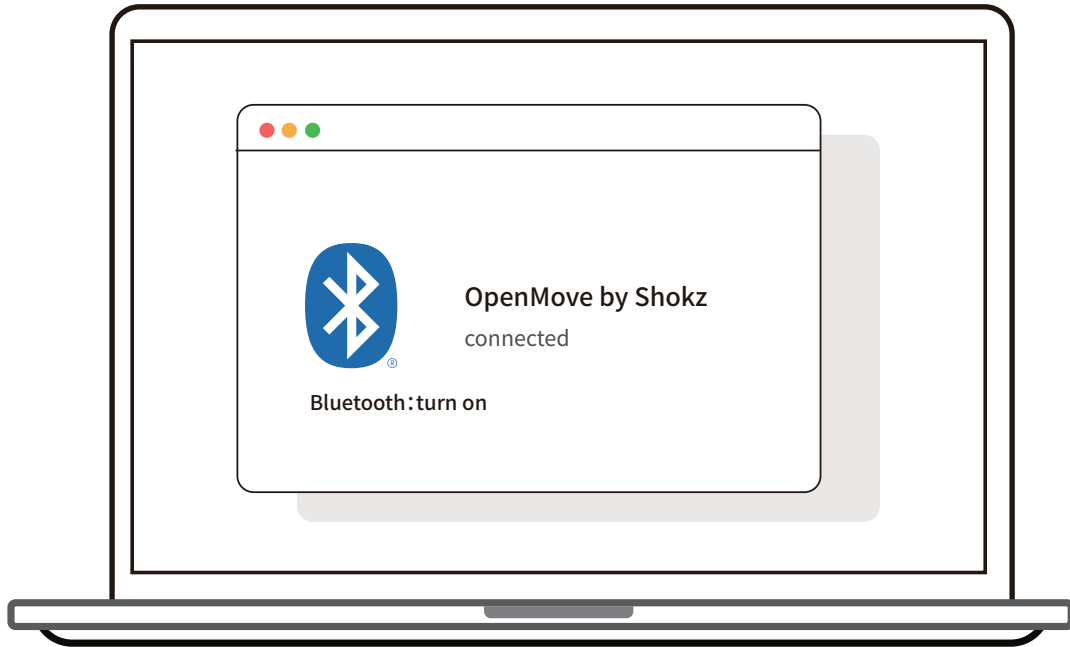

## Second Device



Audrey will say "connected".

6.Re-enter pairing mode by pressing and holding Volume + until Audrey says “pairing” and the LED indicator flashes red and blue alternately.

7.Open second device's Bluetooth® menu and select "OpenMove by Shokz."Audrey will say "connected."

8.Turn your headphones off.

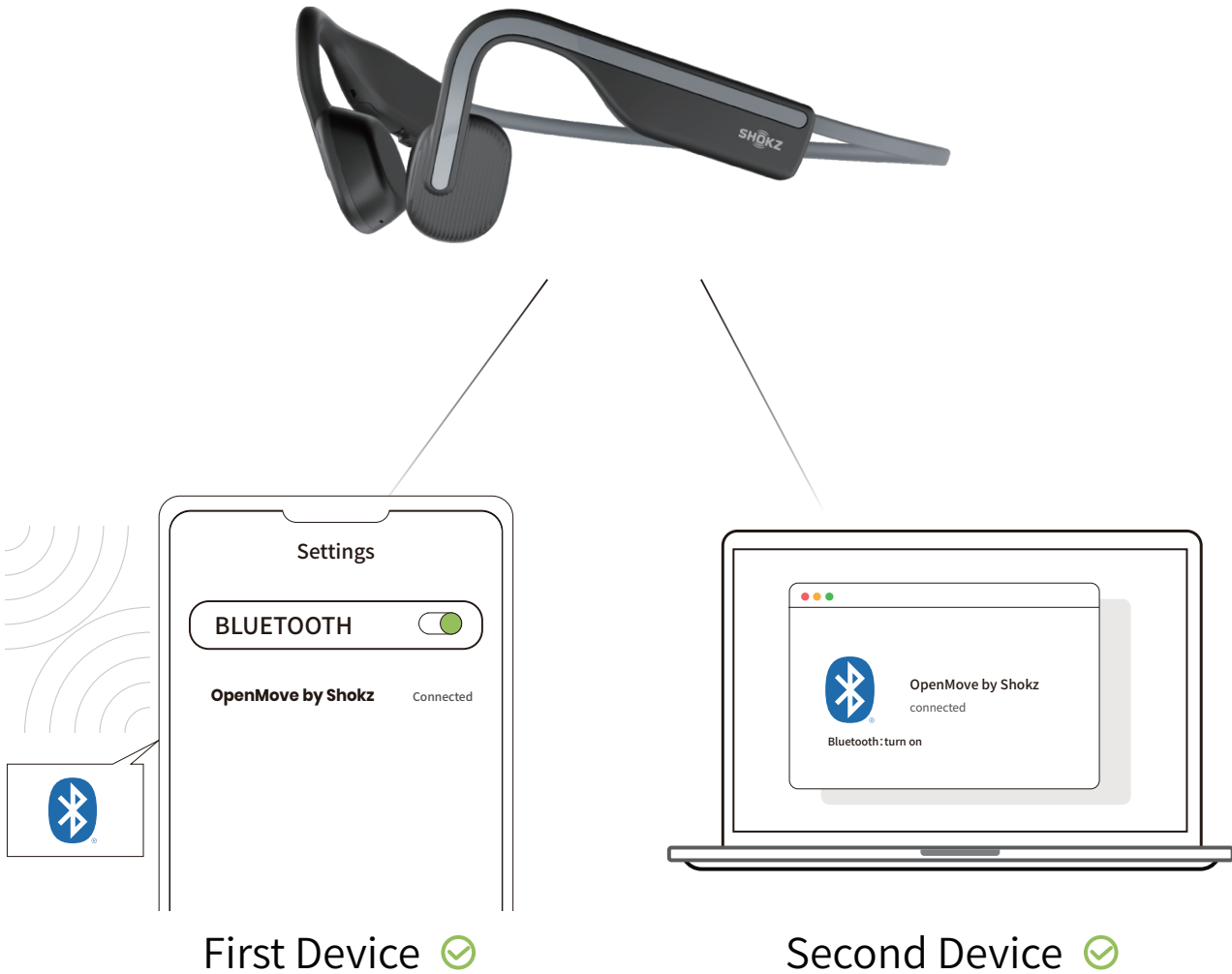

You will hear a beep, then Audrey will say “Welcome to Shokz, connected. Second device connected.”

9. Turn your headphones on. Your headphones are now connected to both devices.

# Turn Multipoint Pairing Off

**OFF** Operate controls with headphones powered off.

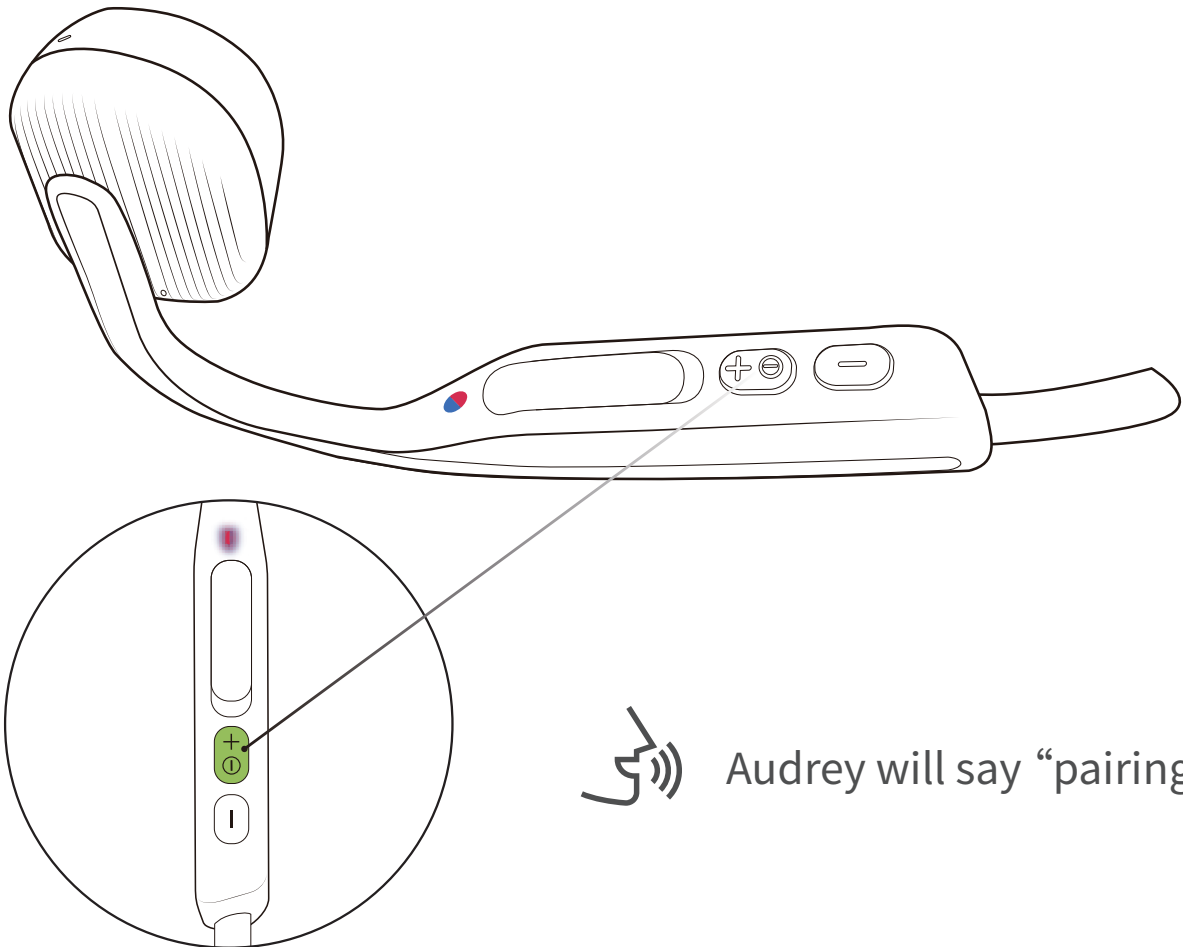

1. Start with your headphones powered off.
2. Press and hold Volume + until Audrey will say “pairing” and the LED indicator flashes red and blue alternately.

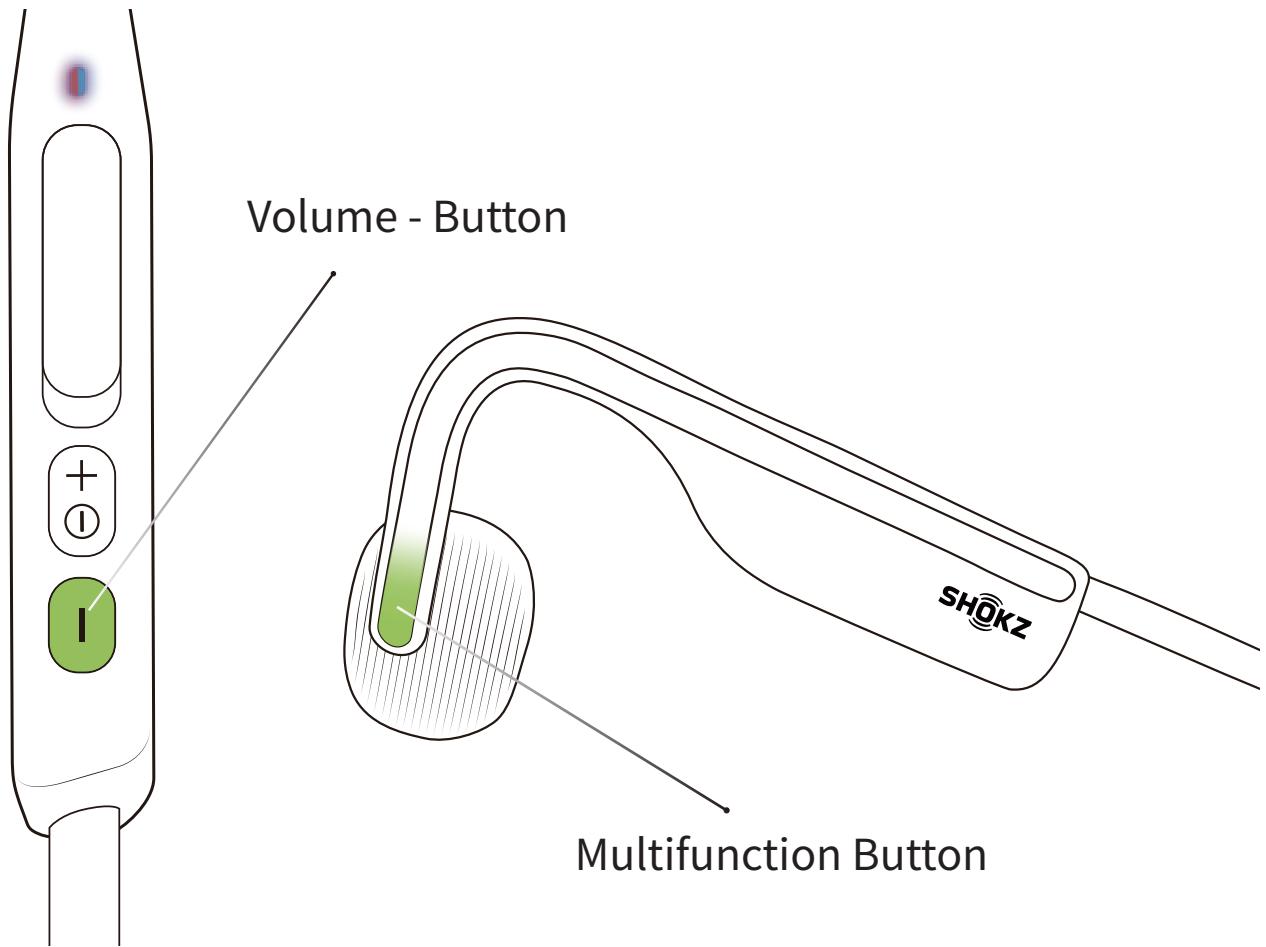

 Audrey will say "multipoint disabled."

3. Press and hold the multifunction button and Volume - button until Audrey will say "multipoint disabled."

# Restore Factory Settings

**OFF** Operate controls with headphones powered off.

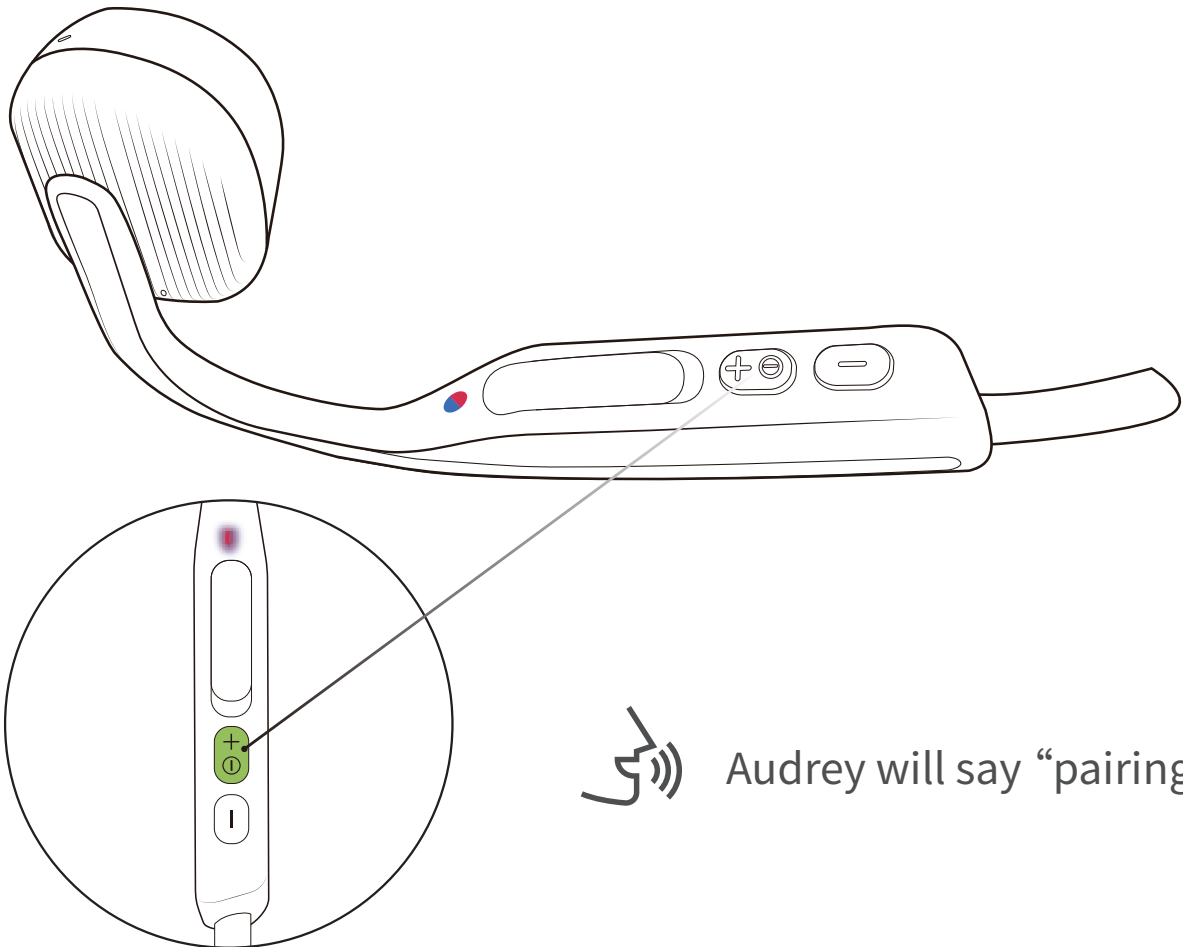

1. Start with your headphones powered off.
2. Press and hold Volume + until Audrey will say “pairing.” and the LED indicator flashes red and blue alternately.



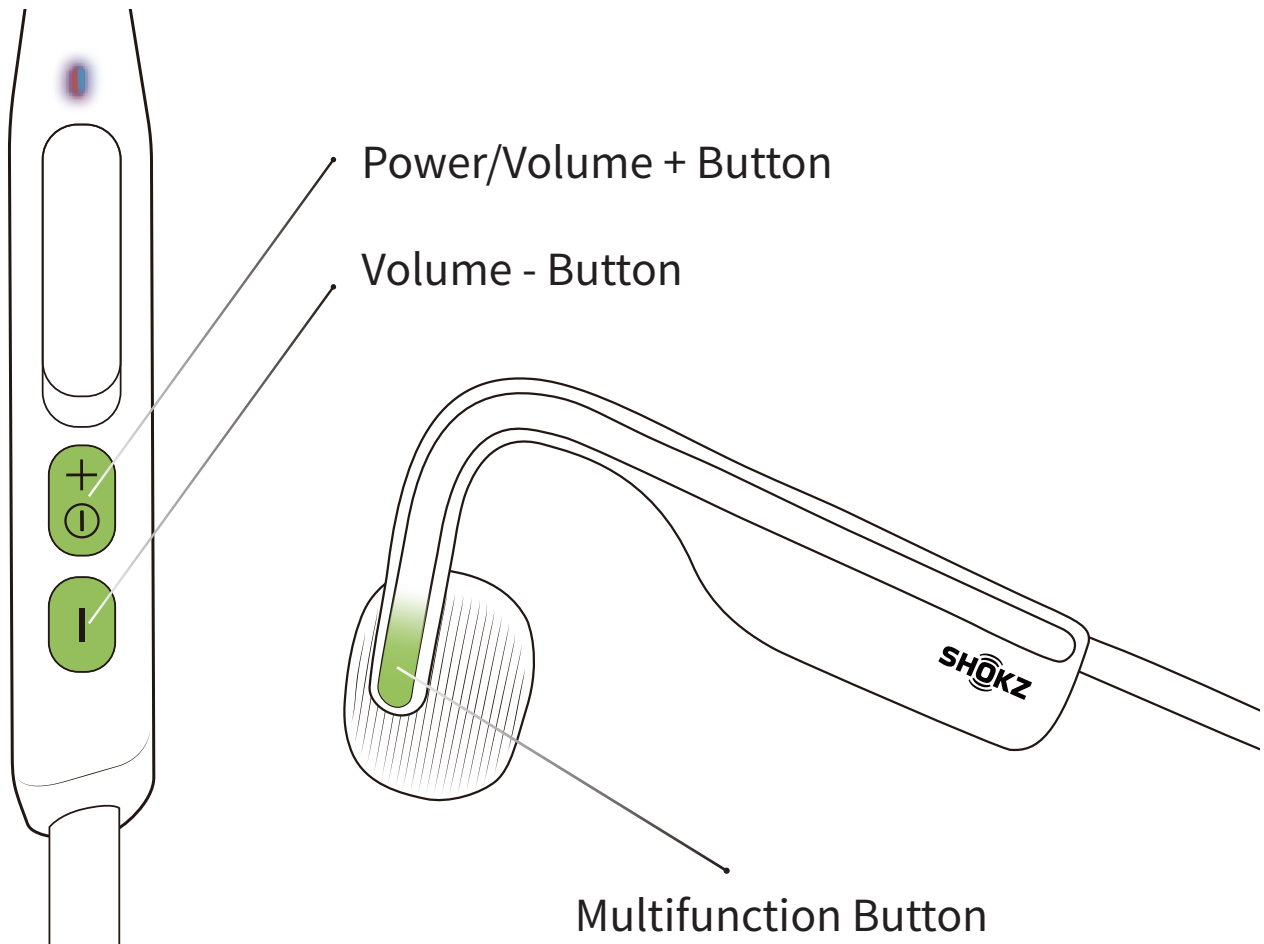

3. Press and hold the multifunction button, Volume – button and Volume + button until hear two beeps and feel the vibration.

4. Turn your headphones off. OpenMove is now reset and can be re-paired to your device.

# Changing Languages

Your headphones have four built-in languages:

**Chinese, English, Japanese and Korean.**

**OFF** Follow the instruction when  
headphones powered off

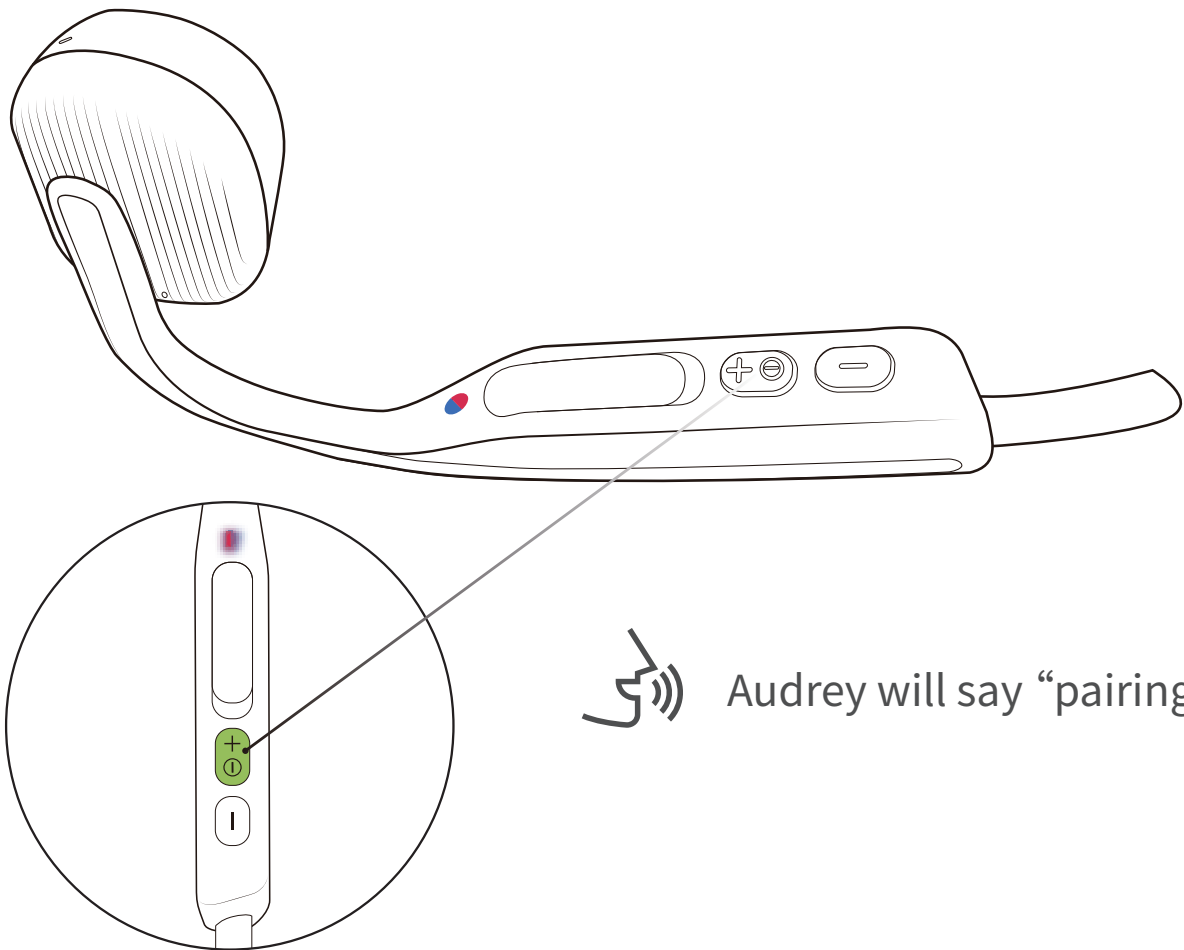

1. Start with your headphones powered off.
2. Press and hold Volume + until Audrey will say “pairing” and the LED indicator flashes red and blue alternately.

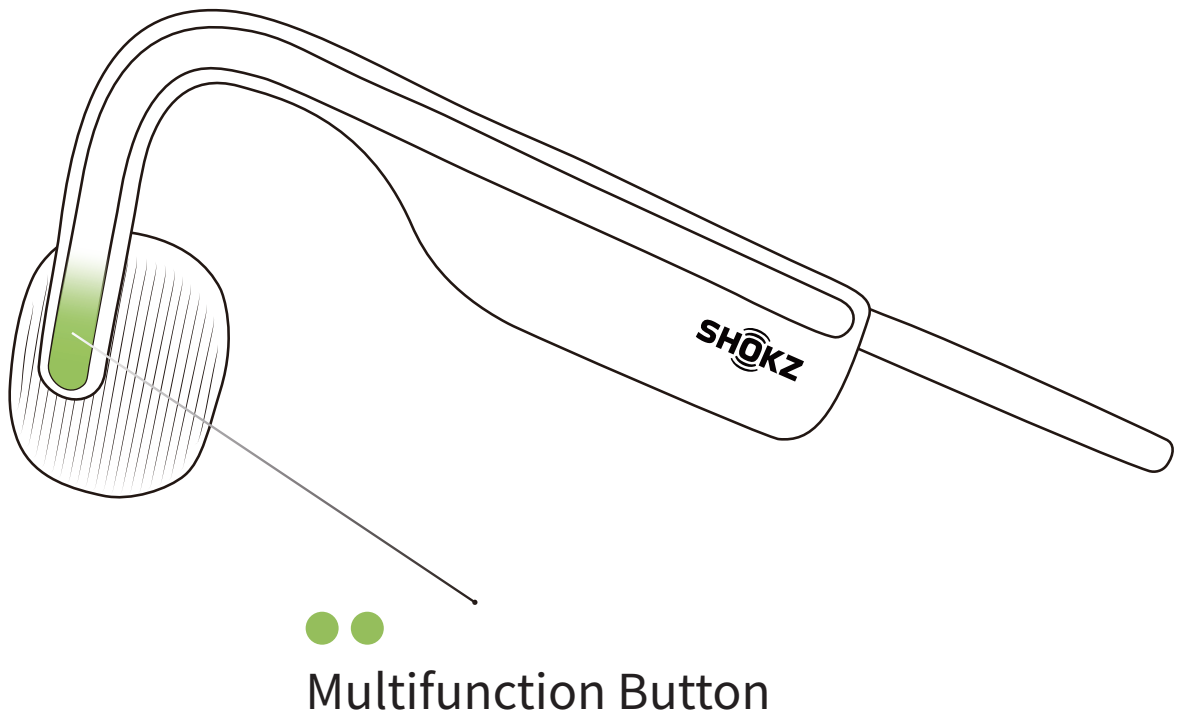

3. Double-press the multifunction button. Languages have been switched when you hear the corresponding language.

---

# Care and Maintenance

# Charging Tips

- OFF** The headset will automatically shut down when charging

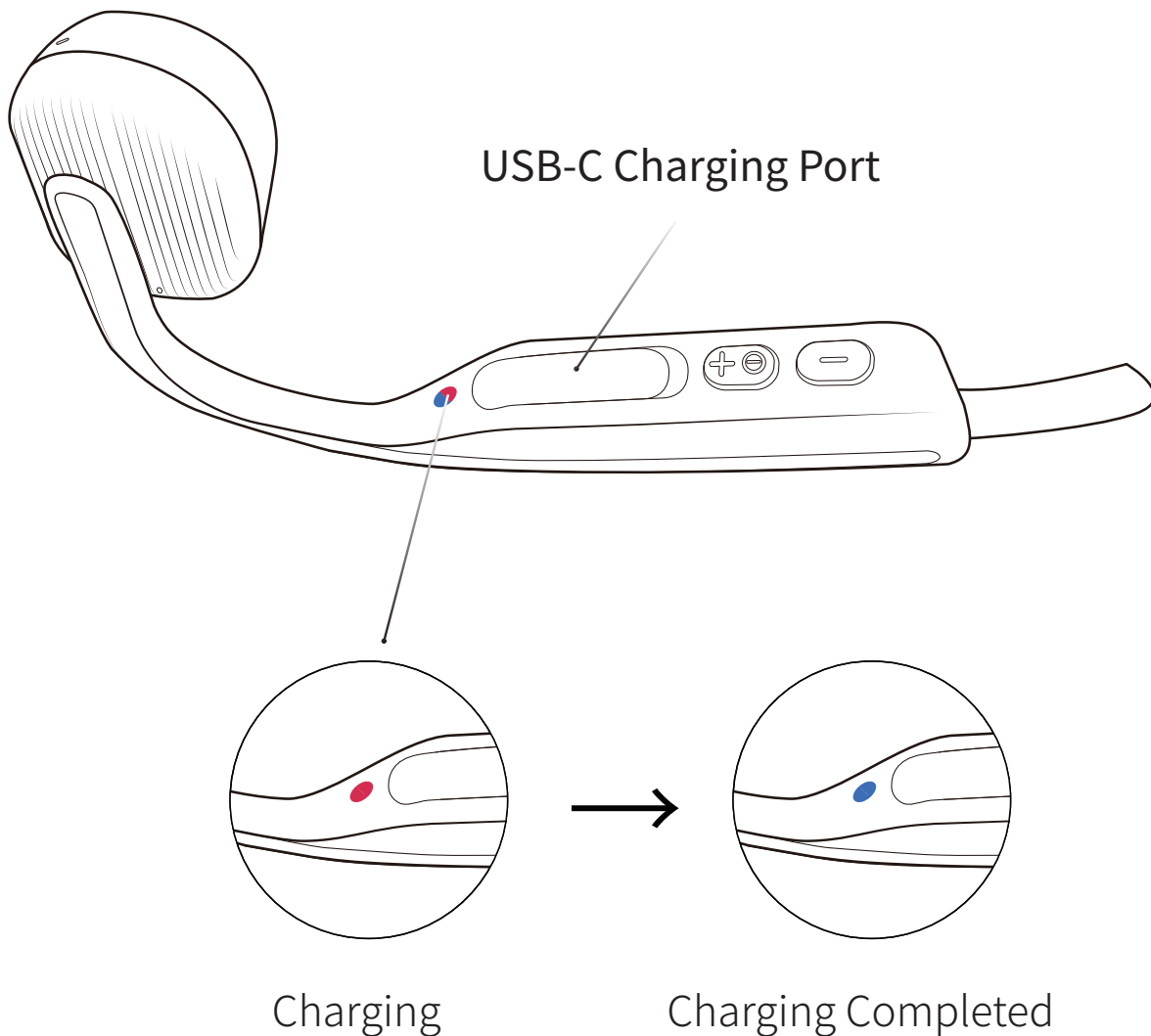

When the headphones are at low battery, there will be a “charge me” prompt and the red light will flash intermittently. Use the corresponding USB-C cable for charging.

The LED indicator will turn red during the charging process and the headphones will automatically turn off. The LED indicator will turn from red to blue when charging is complete.

# Storage and Maintenance

- Store the headphones in a cool, dry place. The working temperature should be 0~45°C(32~113°F). Working in a cold/hot temperature, highly humid area, or low air pressure environment may reduce the battery life.
- Keep the product away from heat sources, direct sunlight, combustible gas or other liquids.
- Keeping the charging port dry before connecting to the charger will reduce the risk of damage.
- These headphones are water-resistant, but are not waterproof. Please do not submerge the headphones in water.
- Clean the headphones with a soft dry cloth.
- Do not charge right after exercising, in case there's sweat inside the charging port, which could lead to circuit burning while charging.
- After storage for a long period, please charge the headphones before using again.

A circular icon containing the letters 'BC' in a bold, sans-serif font.

## Note

Design and specification are subject to change without notice. For the most up-to-date product information, please visit <https://shokz.com>.

## Warning

To avoid the risk of explosion, fire, or leakage from toxic chemicals, please do not disassemble the product or replace, deform, or mutilate the battery.

# Warranty

Your headphones are covered by a warranty.

Visit our website at <https://shokz.com/pages/warranty-landing> for details of the limited warranty.

\*Failure to register will not affect your limited warranty rights.

# Troubleshooting



If you have any trouble or problems, please visit  
<https://shokz.com/pages/faq>  
for more support!



# What's in the Box



OpenMove  
Box\*1

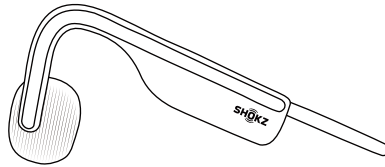

OpenMove  
headphone\*1

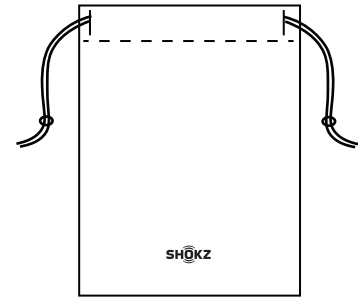

OpenMove  
Package\*1



USB-C Cable\*1

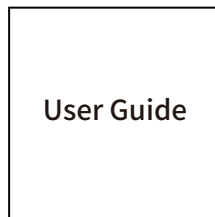

OpenMove  
User Guide\*1

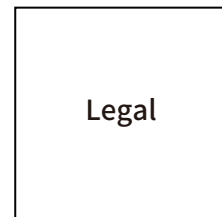

OpenMove  
Legal Statement\*1

If any part of your product is damaged or missing, do not use it. Contact authorized Shokz dealer or Shokz customer service.

\*Please note that the packaging envelope may vary depending on the sales region.

# Regulatory and Legal Information

## FCC Caution

Any changes or modifications not expressly approved by the party responsible for compliance could void the user's authority to operate the equipment. This device complies with Part 15 of the FCC Rules.

Operation is subject to the following two conditions:

- (1) this device may not cause harmful interference, and
- (2) this device must accept any interference received, including interference that may cause undesired operation.

## FCC Statement

This equipment has been tested and found to comply with the limits for a Class B digital device, pursuant to part 15 of the FCC Rules.

These limits are designed to provide reasonable protection against harmful interference in a residential installation. This equipment generates, uses and can radiate radio frequency energy and, if not installed and used in accordance with the instructions, may cause harmful interference to radio communications. However, there is no guarantee that interference will not occur in a particular installation.

If this equipment does cause harmful interference to radio or television reception, which can be determined by turning the equipment off and on, the user is encouraged to try to correct the interference by one or more of the following measures:

- Reorient or relocate the receiving antenna.
- Increase the separation between the equipment and receiver.
- Connect the equipment into an outlet on a circuit different from that to which the receiver is connected.
- Consult the dealer or an experienced radio/TV technician for help.

This equipment complies with FCC/IC radiation exposure limits set forth for an uncontrolled environment and meets the FCC radio frequency (RF) Exposure Guidelines and RSS-102 of the IC radio frequency (RF) Exposure rules. This equipment has very low levels of RF energy that is deemed to comply without testing of specific absorption rate (SAR).

Responsible party (contact for FCC matters only):

AfterShokz LLC.

3200 Gracie Kiltz Lane, Suite 400 Austin, TX 78758 USA

<https://shokz.com>

## Industry Canada

This device complies with Industry Canada licence-exempt RSS standard(s): Operation is subject to the following Two conditions: (1) this device may not cause interference, and (2) this device must accept any interference, including interference that may cause undesired operation of the device.

## CE Declaration of Conformity

Shokz Holding Limited hereby declares that this product is in compliance with the essential requirements and other relevant provisions of Directive 2014/53/EU and all other applicable EU Directive requirements. The complete declaration of conformity can be found at:

<https://shokz.com/pages/policies>. Shokz' s EU representative is AfterShokz Euro B.V., Schipholweg 103, 2316XC Leiden, Netherlands.

Frequency Range	Max. Transmit Power
2400-2483.5MHz	1dBm(EIRP)



## UK Declaration of Conformity

Shokz Holding Limited hereby declares that this product is in compliance with the essential requirements and all other applicable United Kingdom' s regulations. The complete declaration of conformity can be found at: <https://shokz.com/pages/policies>.

Shokz' s authorised representative in the UK is Pinpoint Consumer Electronics Ltd., Unit 35, Meridian House, Road One, Winsford Industrial Estate, Winsford, Cheshire CW7 3QG.



## WEEE Declaration of Conformity

This WEEE logo means that this product must not be discarded

as household waste, and should be delivered to an appropriate collection facility for recycling. Proper disposal and recycling helps protect natural resources, human health and the environment. For more information on disposal and recycling of this product, contact your local municipality, disposal service, or the shop where you bought this product.



### Australia/New Zealand



### Singapore

**Complies with  
IMDA Standards  
DA106614**

### Philippines



**SHOKZ**