



RAZER KAIRA

MASTER GUIDE

Whether you're on console or mobile, rule both realms with the **Razer Kaira**—a dual wireless PS5™ headset powered by Razer™ SmartSwitch. Capable of connecting to a 2.4GHz and Bluetooth device at once, enjoy unrivalled convenience as you switch seamlessly between them.

CONTENTS

1. WHAT'S INSIDE / WHAT'S NEEDED	3
2. LET'S GET YOU COVERED	5
3. TECHNICAL SPECIFICATIONS	6
4. GETTING STARTED.....	7
5. USING YOUR HEADSET	10
6. SAFETY AND MAINTENANCE	18
7. LEGALESE.....	19

1. WHAT'S INSIDE / WHAT'S NEEDED

WHAT'S INSIDE

- Razer Kaira

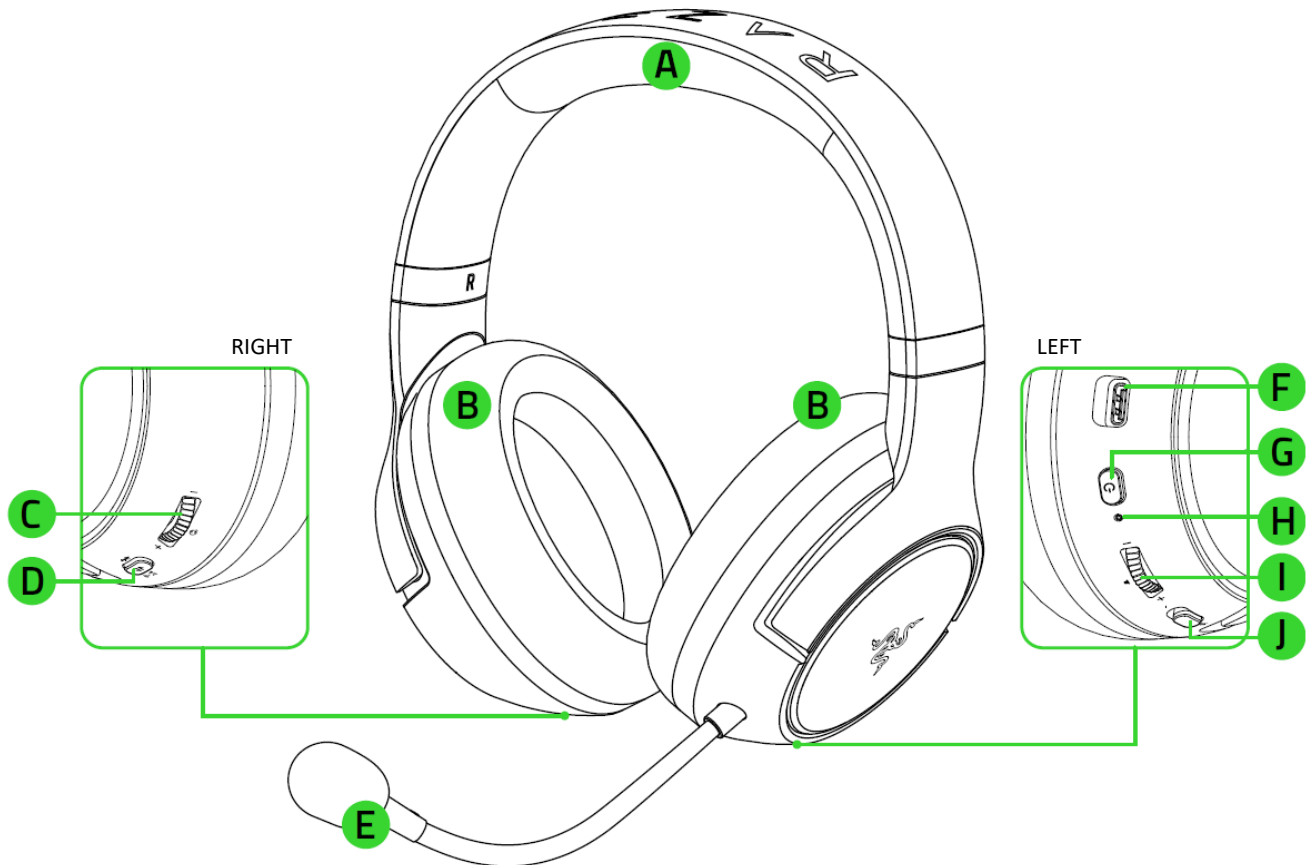

- A. Auto-adjusting headband
- B. FlowKnit memory foam ear cushions
- C. Sidetone wheel
- D. Razer SmartSwitch / EQ button
- E. Bendable Razer™ HyperClear cardioid mic

- F. Charging port
- G. Power button
- H. Status indicator
- I. Volume wheel
- J. Mic mute switch

- Type-C wireless dongle



- Type-A to Type-C charging cable

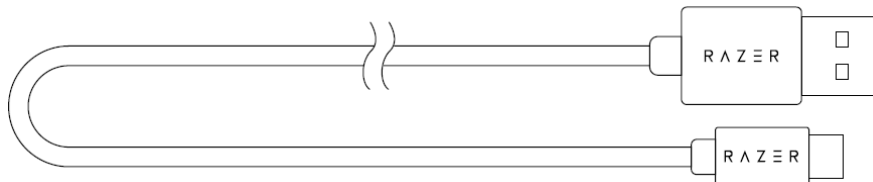

- Type-A to Type-C adapter cable

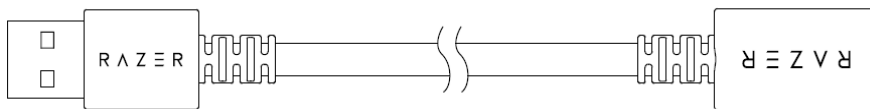

- Important Product Information Guide

WHAT'S NEEDED

Product requirements

- PlayStation®4 / PlayStation®5 or PC (Windows® 10 64-bit or higher)
- USB Type-C or Type-A port
- Devices with Bluetooth audio capability

Razer Audio App requirements

- iOS 12 / Android 8.1 Oreo (or higher) device with Bluetooth connectivity
- Internet connection for app installation

2. LET'S GET YOU COVERED

You've got a great device in your hands, complete with a 2-year limited warranty coverage. Now maximize its potential and score exclusive Razer benefits by registering at razerid.razer.com

*Your product's
serial number can
be found here.*

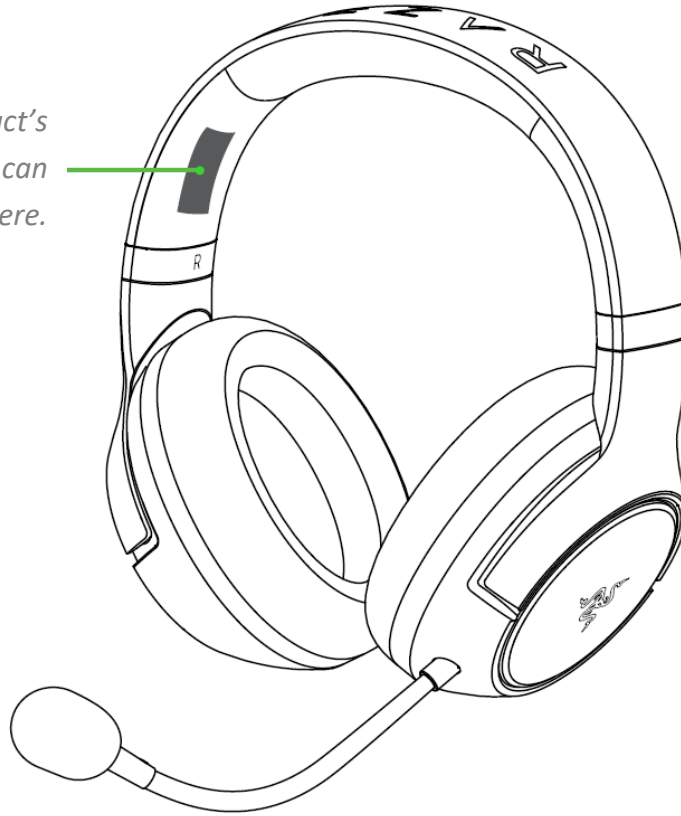

Got a question? Ask the Razer Support Team at support.razer.com

3. TECHNICAL SPECIFICATIONS

HEADPHONES

- Frequency response: 20 Hz – 20k Hz
- Impedance: 32Ω at 1 kHz
- Sensitivity (@1 kHz): 108 dB
- Drivers: 50 mm, with Neodymium magnets
- Inner ear cup diameter: Width 45mm / Length 65mm
- Oval ear cushions: Designed for full-ear coverage with heat-transfer fabric, perfect for long-wearing comfort
- Connection type: Wireless via Type-C dongle / Bluetooth
- Wireless range: 10 m / 30 ft
- Wireless frequency: 2.4 GHz
- Battery life: Up to 30 hours

MICROPHONE

- Fixed mic boom
- Frequency response: 100 – 10,000 Hz
- Signal-to-noise ratio: > 60 dB
- Sensitivity (@1 kHz): -54 ± 3 dB
- Pick-up pattern: Unidirectional

RANGE

- Bluetooth wireless range: Up to 10 m / 30 ft

SYSTEM REQUIREMENT

- PlayStation 5 / PlayStation 4
- PC
- Devices with Bluetooth audio capacity

4. GETTING STARTED

CHARGING THE HEADSET

Connect the Razer Kaira to a powered USB port using the charging cable. For best results, please fully charge the headset before using it for the first time. A depleted headset will fully charge in about 4 hours.

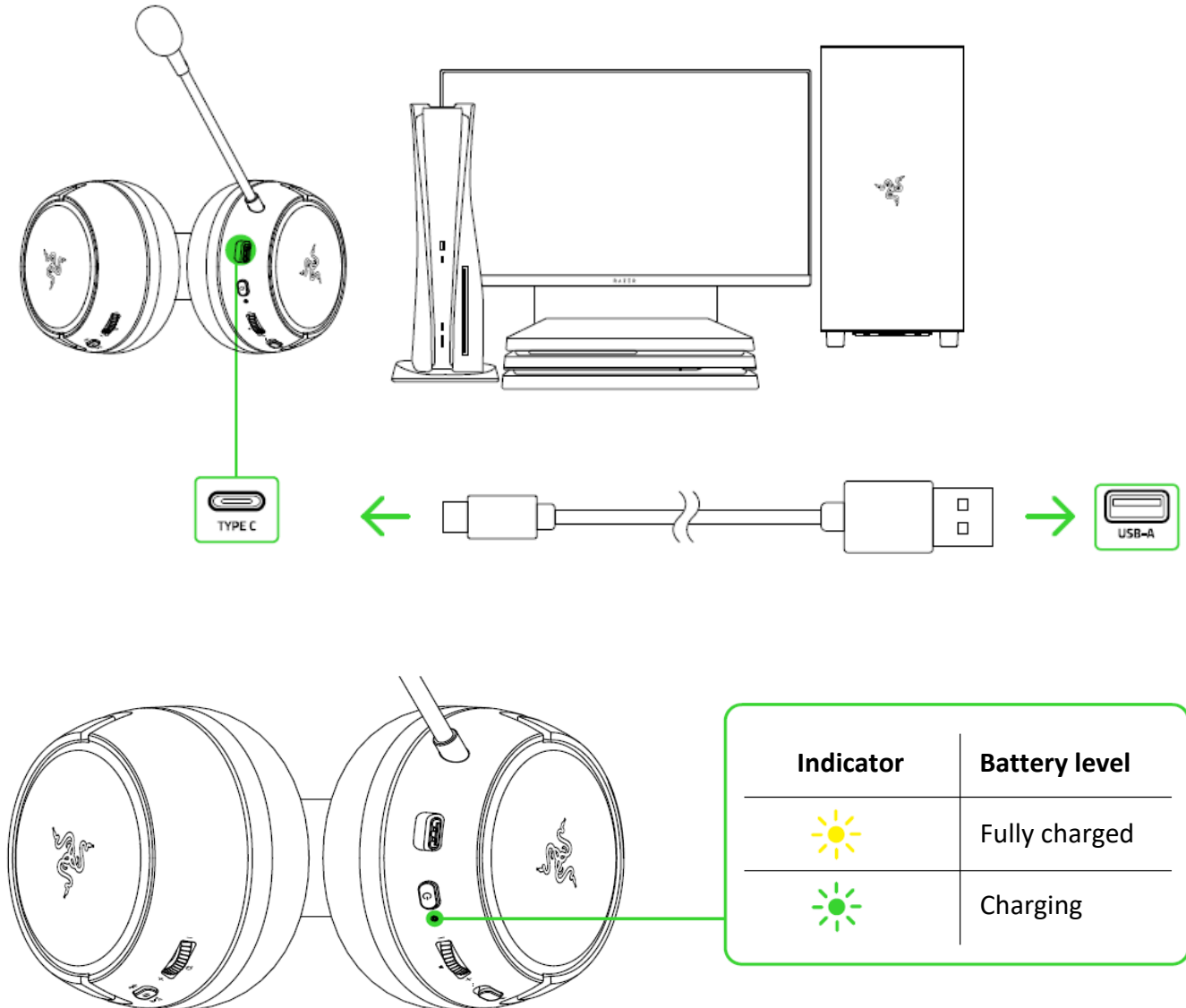

CONNECTING YOUR HEADSET

A. TO A PLAYSTATION CONSOLE / PC VIA 2.4GHZ

1. Plug the Type-C wireless dongle to your PlayStation console or PC.

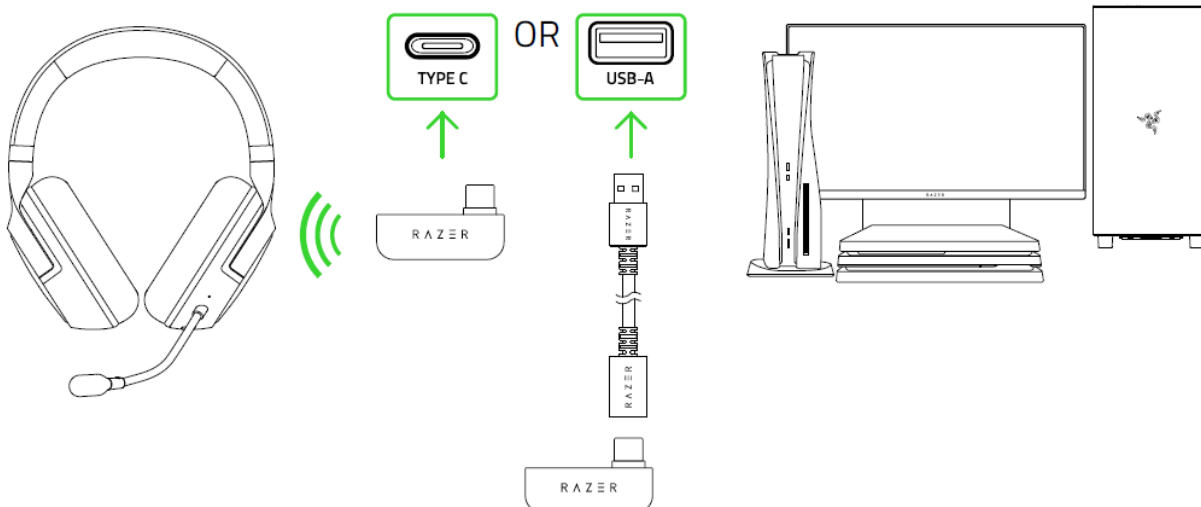

2. Press and hold the Power button until the status indicator is briefly lit or until you hear a voice prompt.

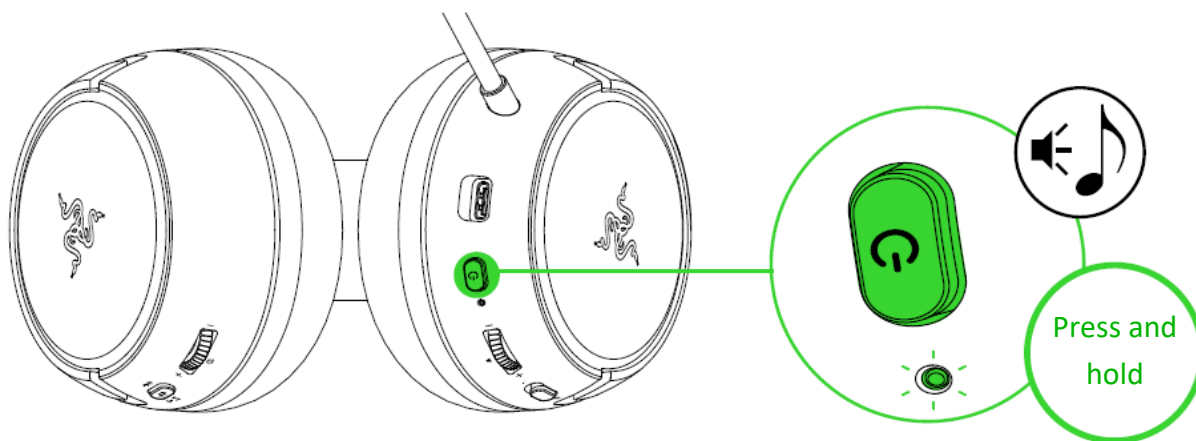

3. Wait until the status indicator briefly becomes static green indicating that the headset is now connected to the Type-C wireless dongle.

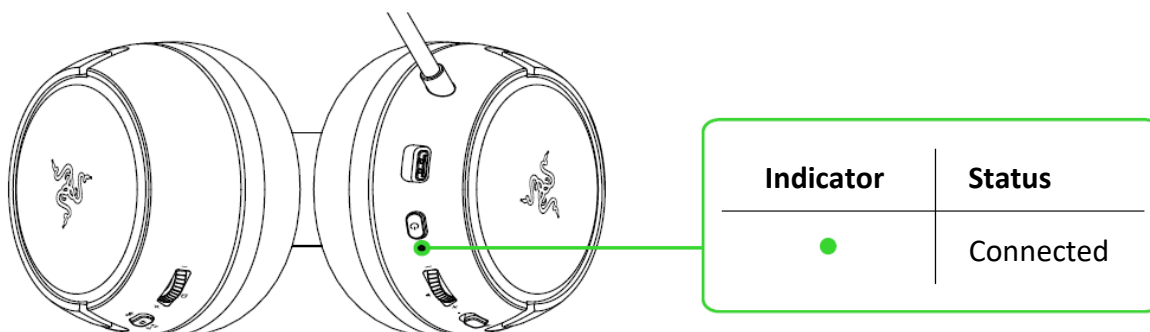

4. On your PlayStation console or PC, set the Razer Kaira as the default **Input** and **Output Device**.

On **PlayStation 5**, go to **Settings > Sound**

- On **Microphone**, set the **Input Device** to **Razer Kaira (2.4)**.
- On **Audio Output**, set the **Output Device** to **Razer Kaira (2.4)**.

On **PlayStation 4**, go to **Settings > Devices > Audio Devices**

- Set the **Input Device** and **Output Device** to **Razer Kaira (2.4)**.

On **PC / Laptop**

- a. Right click on the sound icon on the system tray and then select **Open Sound settings**.
- b. On the Sound window, set **Razer Kaira (2.4)** as the default **Output** and **Input** device.

B. TO OTHER DEVICES VIA BLUETOOTH

While powered on, press the Razer SmartSwitch / EQ button for 5 seconds to activate Bluetooth pairing mode. Follow your device's instructions and select "**Razer Kaira (BT)**" from the list of found devices. The status indicator will briefly change to static blue to indicate that the headset is now paired with your device.

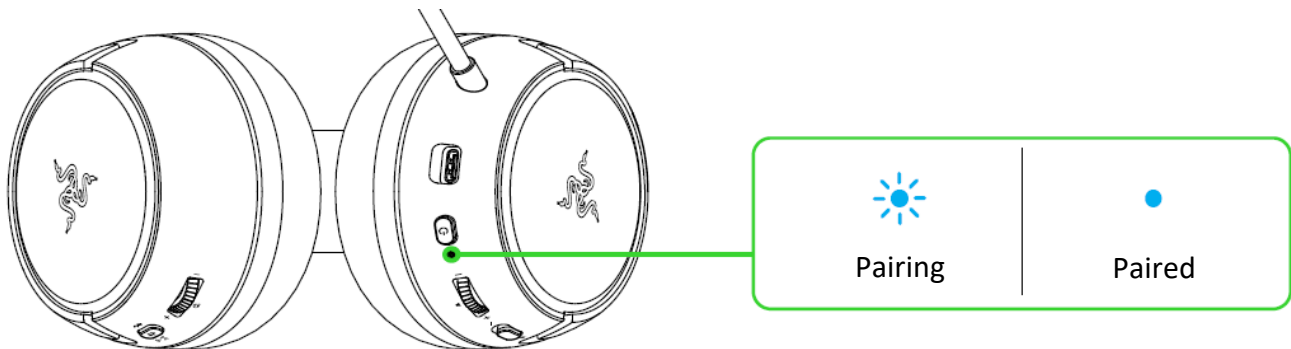

RAZER SMARTSWITCH

With the Razer Kaira connected to a PC or PlayStation console (via 2.4 GHz) and a mobile device (via Bluetooth), you'll be able to manage calls from your mobile device even while gaming on your PC or

PlayStation console. The status indicator will briefly show static white to indicate that the headset is connected to both audio sources.

5. USING YOUR HEADSET

BATTERY LEVEL

When unplugged and powered on, the status indicator will show the connection and battery status.

While in use, you'll hear a voice prompt when the headset needs to be recharged; during such time, the indicator will continue showing the battery level until you charge the headset.

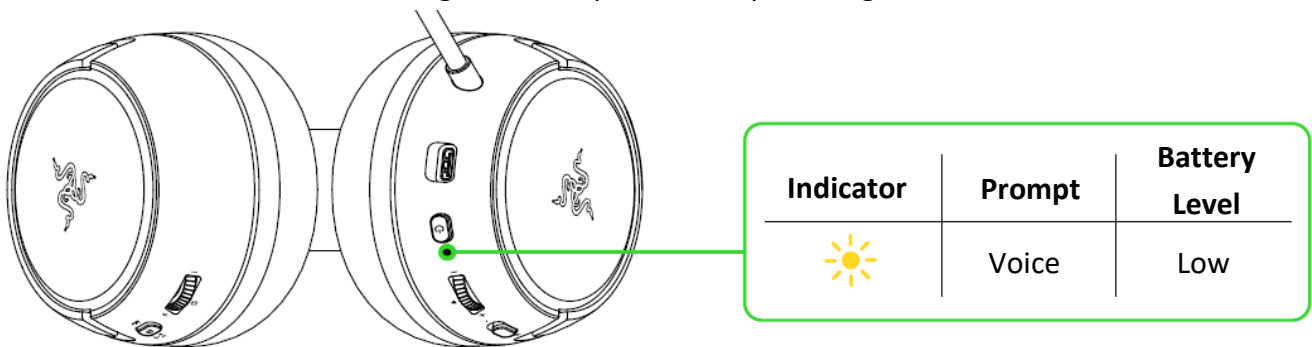

POWER BUTTON

Power ON / OFF

Power on the headset by holding the Power button until the status indicator is on; and holding the Power button again to turn off. An audio prompt will help notify you when the headset is powered on or off.

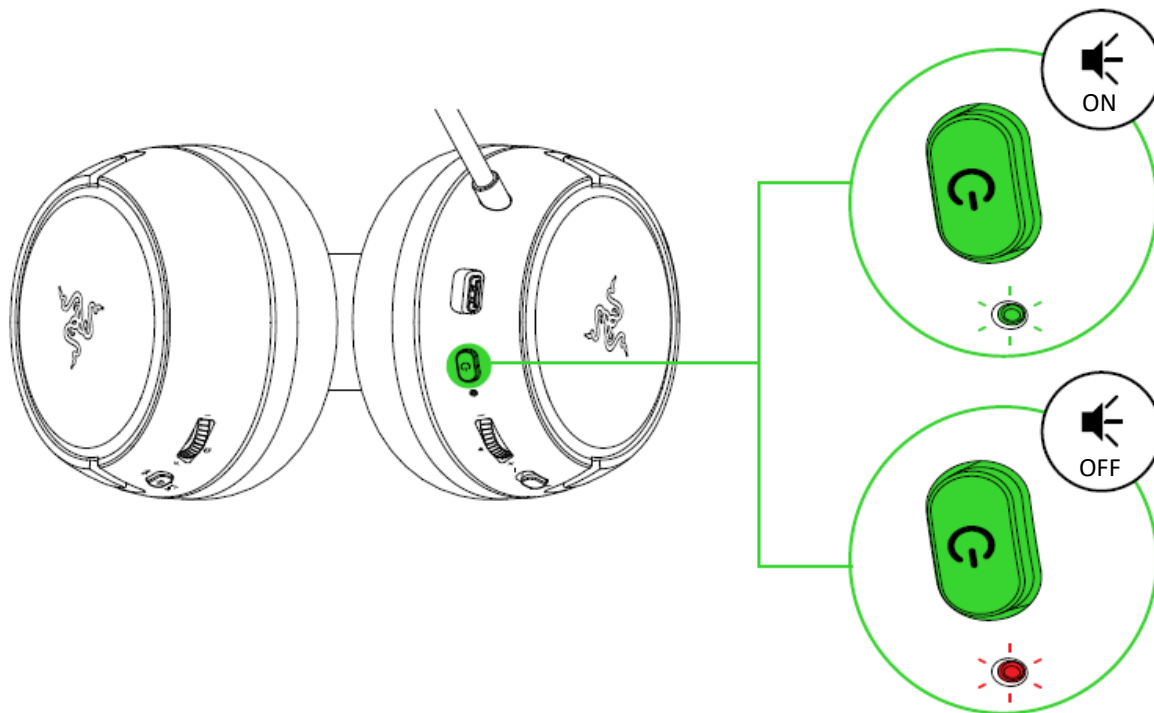

Other functions

Other power button functions are available when the headset is powered on and connected to your device via Bluetooth. These functions operate based on your device's current activity.

Single press	Play/pause
	Accept incoming call or end current call
	Put call on-hold and accept incoming call
	End call and swap to on-hold call
Double press	Reject incoming call
	Swap calls
	Skip track
Triple press	Previous track
While powered off, press and hold for 5 seconds	Activate Bluetooth pairing mode

 *Some features listed here may not be applicable to certain devices.*

RAZER SMARTSWITCH / EQ BUTTON

Switching EQ Presets

Press the Razer SmartSwitch / EQ button to switch between Default, Amplified, Enhanced Bass, FPS, and Custom* EQ presets available on the headset.

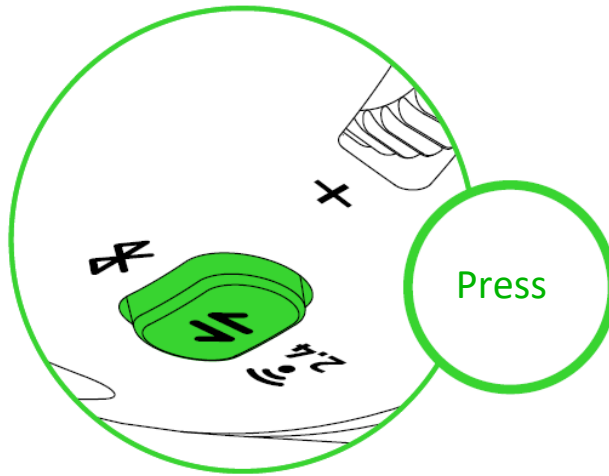

**This preset will only be available when you customize a preset on the Razer Audio app.*

Switching audio source

When powered on and connected to any audio source, double press the Razer SmartSwitch / EQ button to switch between 2.4 GHz and Bluetooth audio source or vice versa.

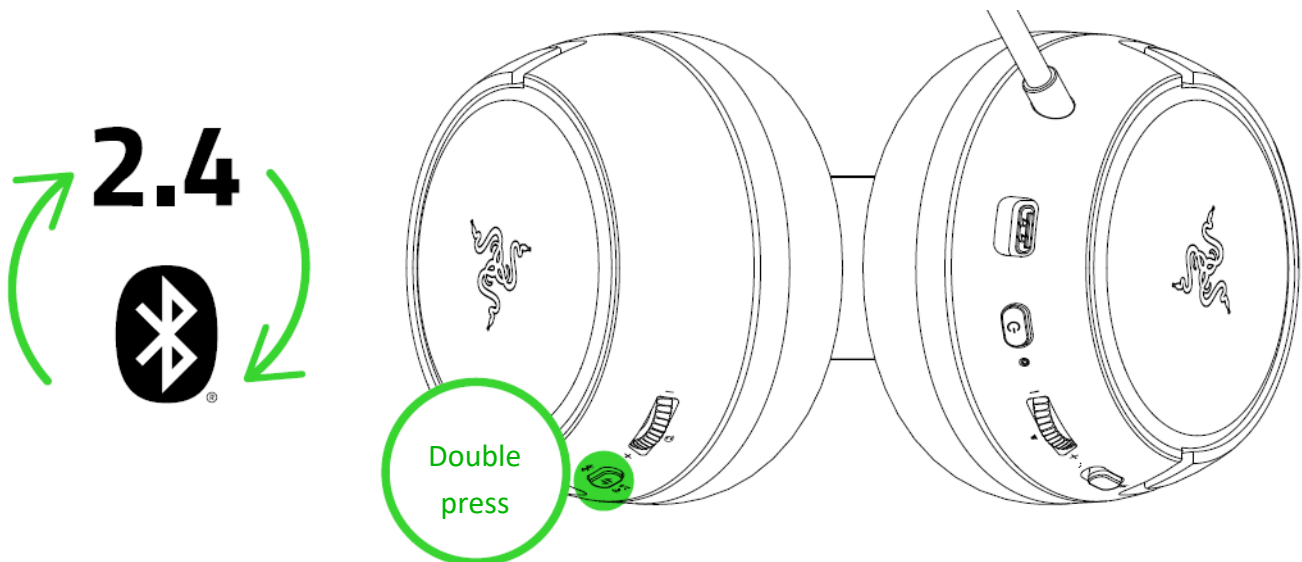

i *Using Bluetooth as the audio source will reconnect the headset to the last known device. Pairing mode will be activated if no device is found.*

Enable / Disable Gaming Mode

While connected via Bluetooth, triple press the Razer SmartSwitch / EQ button then hold the last press for 2 seconds to activate Gaming Mode. Once enabled, the headset will function at a lower latency; giving you real-time audio feedback while gaming. Repeat to disable gaming mode.

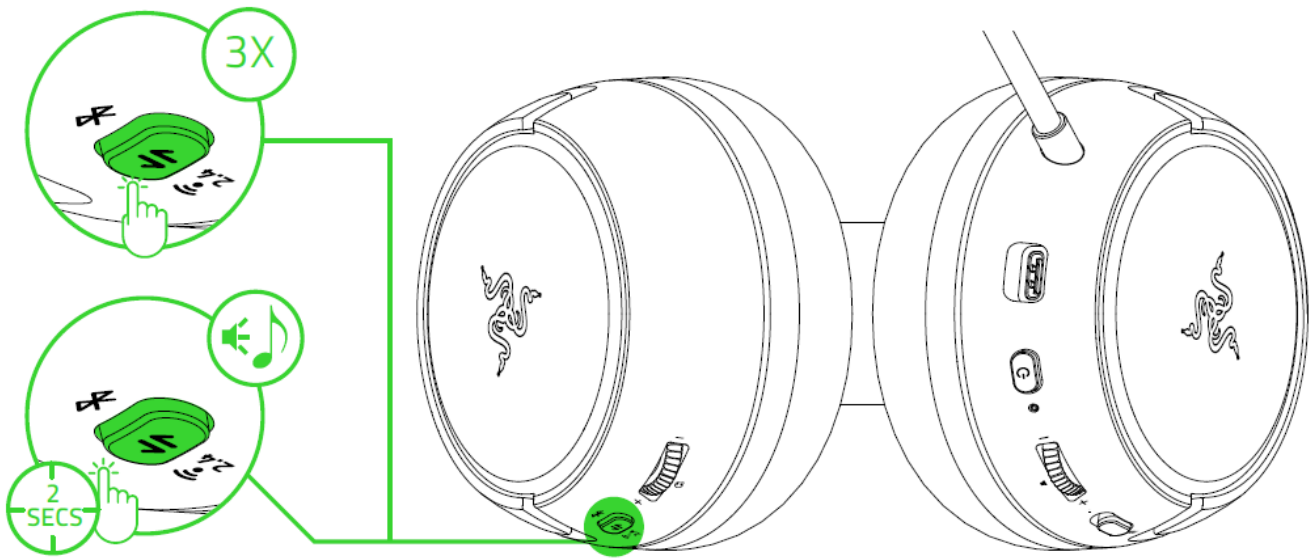

i This feature is only available on Bluetooth connection. For best performance, it is recommended to keep the headset within a very close distance of the audio source.

VOLUME WHEEL

Rotate the Volume wheel to increase or decrease the volume.

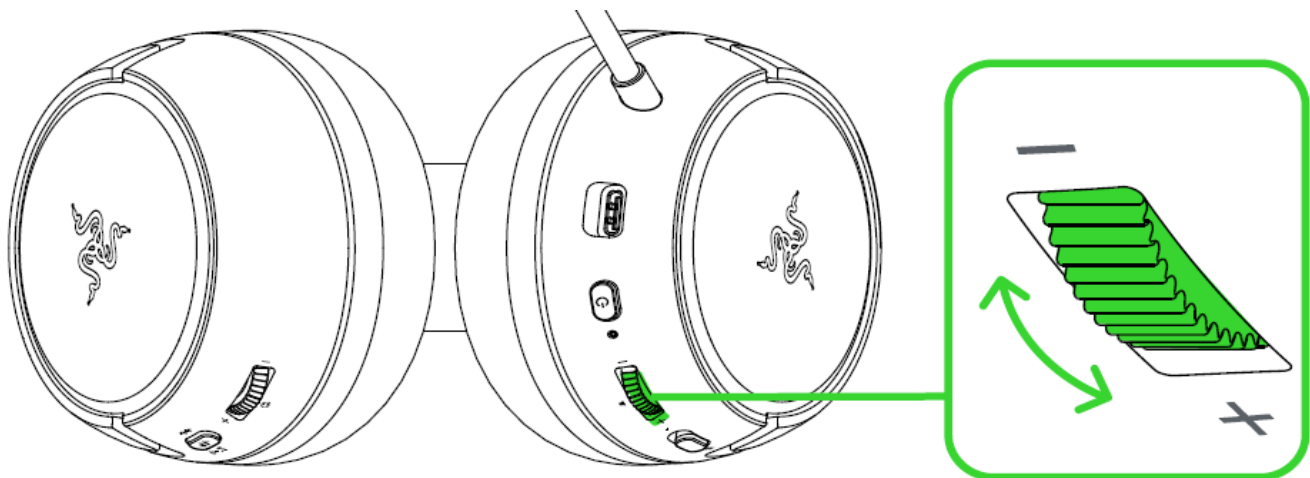

SIDETONE WHEEL

Rotate the Sidetone wheel to adjust the volume of your voice that you can hear through the headset.

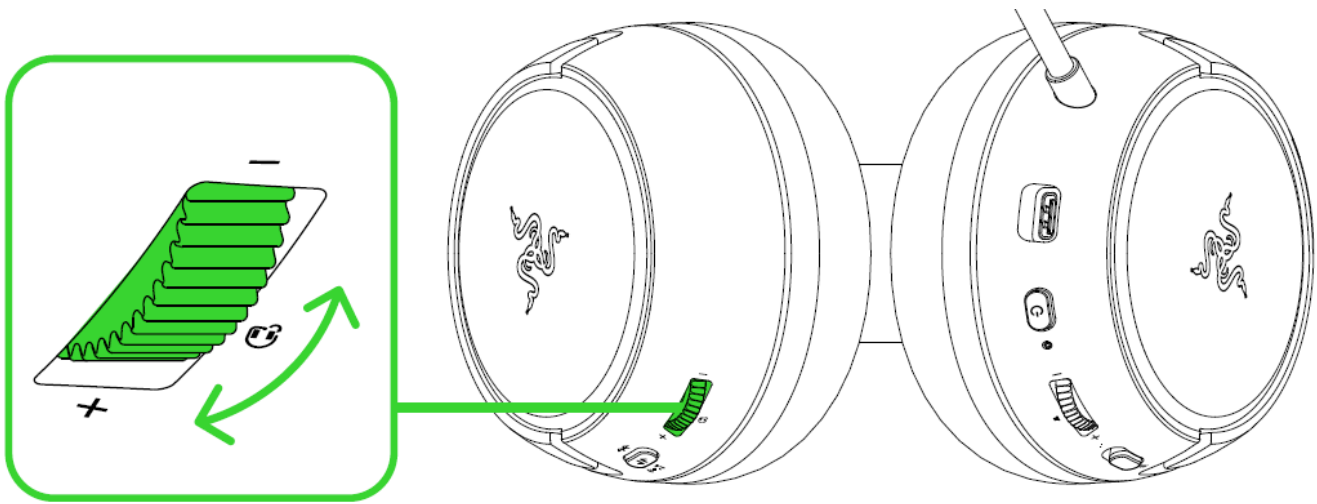

RAZER™ HYPERCLEAR CARDIOID MIC

Bend the Razer™ HyperClear Cardioid mic until it is parallel to your mouth. Make sure the mic diaphragm is in front and the air vent is facing away from your mouth.

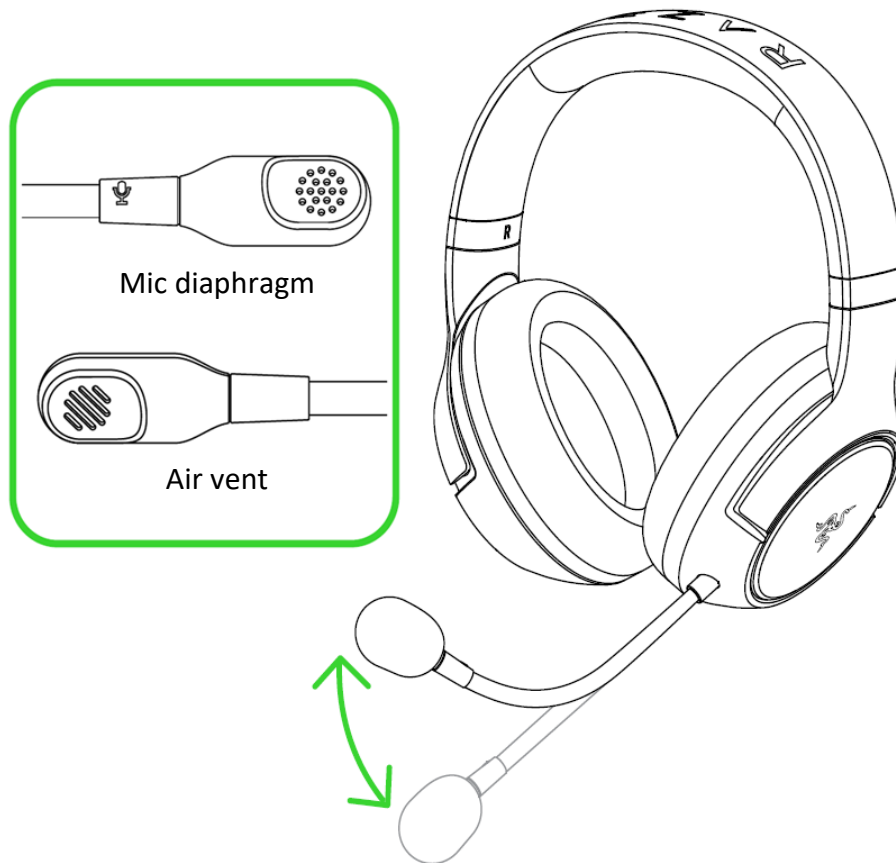

Slide the mic mute switch to mute or unmute the microphone.

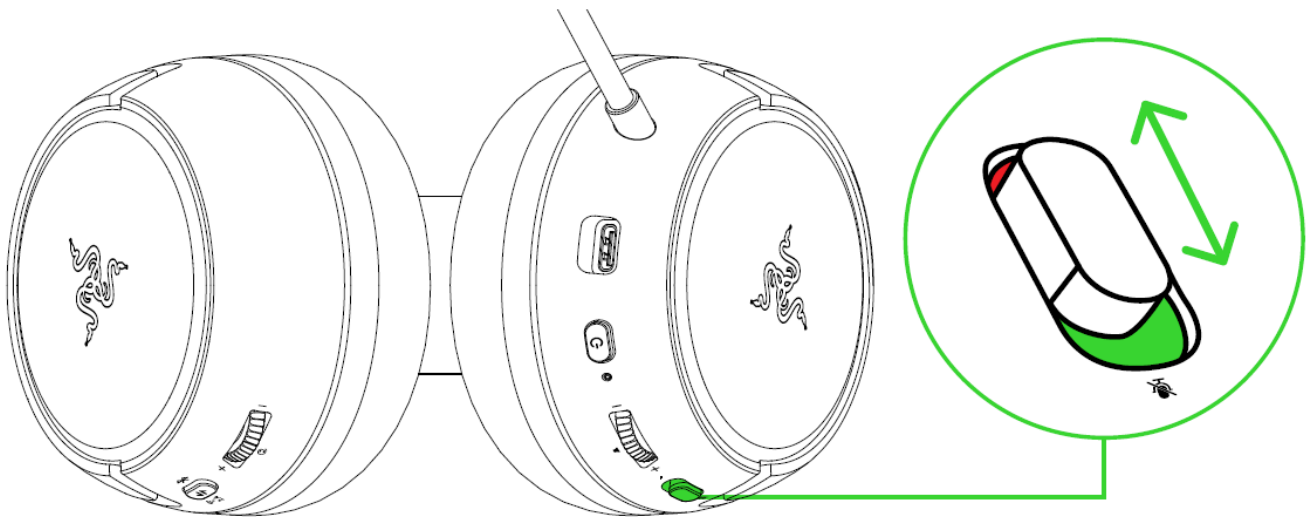

COMFORT

It's recommended to gently stretch the headset before placing it over your head to minimize headband stress, however, don't stretch the headset beyond its limits.

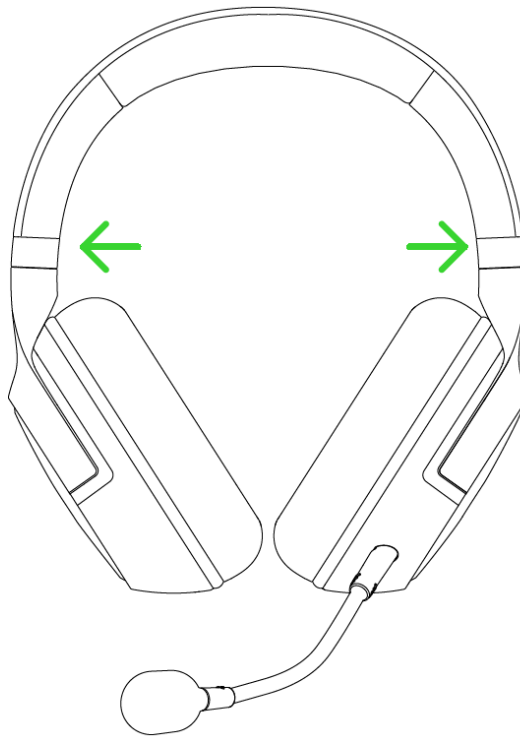

RAZER AUDIO APP

Making advanced customization just got a whole lot easier for your Razer Kaira. With the Razer Audio app, personalize your own EQ setting or cycle through presets, customize its auto shutoff feature, and much more — anytime, anywhere.



AUDIO APP



OR

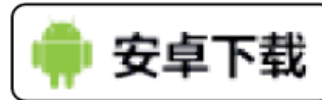

RZR.TO/AUDAPP
(For China Only)

 *When using the app, make sure that the headset is only connected to your mobile device via Bluetooth. A solid blue status indicator indicates this connection.*

6. SAFETY AND MAINTENANCE

SAFETY GUIDELINES

In order to achieve maximum safety while using your Razer Kaira, we suggest that you adopt the following guidelines:

Should you have trouble operating the device properly and troubleshooting does not work, unplug the device and contact the Razer hotline or go to support.razer.com for assistance.

Do not take apart the device (doing so will void your warranty) and do not attempt to operate it under abnormal current loads.

Keep the device away from liquid, humidity or moisture. Operate the device only within the specific temperature range of 0°C (32°F) to 40°C (104°F). Should the temperature exceed this range, unplug and/or switch off the device in order to let the temperature stabilize to an optimal level.

The device isolates external ambient sounds even at low volumes, resulting in lowered awareness of your external surroundings. Please remove the device when engaging in any activities that requires active awareness of your surroundings.

Listening to excessively loud volumes over extended periods of time can damage your hearing. Furthermore, legislation of certain countries permits a maximum sound level of 86db to affect your hearing for 8 hours a day. We therefore recommend that you reduce the volume to a comfortable level when listening for prolonged periods of time. Please, take good care of your hearing.

MAINTENANCE AND USE

The Razer Kaira requires minimum maintenance to keep it in optimum condition. Once a month we recommend you clean it using a soft cloth or cotton swab to prevent dirt buildup. Do not use soap or harsh cleaning agents.

BATTERY WARNING

The Razer Kaira contains a Li-ion rechargeable battery. In general, the life expectancy of such batteries is dependent upon usage. If you suspect that the Li-ion rechargeable battery inside the Razer Kaira may be drained (has a low charge), try charging it.

Caution: Do not open, mutilate, or expose to conducting materials (metal), moisture, liquid, fire, or heat. Doing so may cause batteries to leak or explode, resulting in personal injury. Battery life varies with usage.

7. LEGALESE

COPYRIGHT AND INTELLECTUAL PROPERTY INFORMATION

©2021 Razer Inc. All rights reserved. Razer, the triple-headed snake logo, Razer logo, “For Gamers. By Gamers.” and “Razer Chroma” are trademarks or registered trademarks of Razer Inc. and/or affiliated companies in the United States and other countries. Actual product may differ from pictures. All other trademarks are the property of their respective owners. Warranty not valid outside of product’s intended region.

Android, Google, Google Logo, Google Play, and the Google Play logo are registered trademarks of Google LLC.

Apple, the Apple logo, and iPhone are trademarks of Apple Inc., registered in the U.S. and other countries. App Store is a service mark of Apple Inc. iOS is a trademark or registered trademark of Cisco in the U.S. and other countries and is used under license.

The Bluetooth® word mark and logos are registered trademarks owned by Bluetooth SIG, Inc., and any use of such marks by Razer is under license.

"", "PlayStation", "PS5", and "PS4" are registered trademarks of Sony Interactive Entertainment Inc. All rights reserved. Manufactured and distributed under license from Sony Interactive Entertainment LLC.

Windows and the Windows logo are trademarks of the Microsoft group of companies.

Razer Inc. (“Razer”) may have copyright, trademarks, trade secrets, patents, patent applications, or other intellectual property rights (whether registered or unregistered) concerning the product in this guide. Furnishing of this guide does not give you a license to any such copyright, trademark, patent or other intellectual property right. The Razer Kaira (the “Product”) may differ from pictures whether on packaging or otherwise. Razer assumes no responsibility for such differences or for any errors that may appear. Information contained herein is subject to change without notice.

LIMITED PRODUCT WARRANTY

For the latest and current terms of the Limited Product Warranty, please visit [razer.com/warranty](https://www.razer.com/warranty).

LIMITATION OF LIABILITY

Razer shall in no event be liable for any lost profits, loss of information or data, special, incidental, indirect, punitive or consequential or incidental damages, arising in any way out of distribution of,

sale of, resale of, use of, or inability to use the Product. In no event shall Razer's liability exceed the retail purchase price of the Product.

GENERAL

These terms shall be governed by and construed under the laws of the jurisdiction in which the Product was purchased. If any term herein is held to be invalid or unenforceable, then such term (in so far as it is invalid or unenforceable) shall be given no effect and deemed to be excluded without invalidating any of the remaining terms. Razer reserves the right to amend any term at any time without notice.