

CREATIVE

Sound
BLASTER Z

SB1500 / SB1502

Sound
BLASTER ZX

SB1506

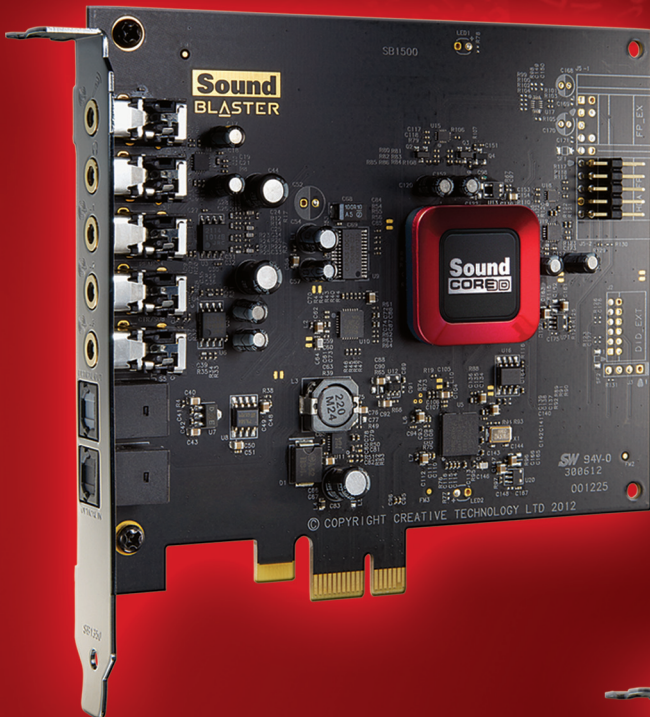

User's Guide

Introduction

Congratulations on your purchase of Creative's latest audio revolution, Sound Blaster Z-Series! With cutting edge technology from the leaders in PC audio, Sound Blaster Z-Series will give you years of reliable entertainment on your PCI Express (PCIe[®]) enabled personal computer.

This User Guide contains software installation and usage information for your audio card.

System Requirements

Minimum Requirements

- Intel[®] Core™2 Duo or AMD[®] processor equivalent (Core™2 2.0 GHz, AMD processor equivalent or faster recommended)
- Intel or AMD compatible motherboard
- Microsoft[®] Windows[®] 8 32-bit or 64-bit; Windows 7 32-bit or 64-bit
- 1 GB RAM
- >600 MB of free hard disk space
- Available PCI Express slot*
- CD or DVD drive for software installation
- High quality headphones or powered amplified speakers (available separately)

Additional Requirements (where applicable)

DVD-Video

- 6x or faster DVD drive
- DVD player software such as InterVideo[®] WinDVD[®] or CyberLink[®] PowerDVD[®] (latest version recommended) installed.
- 5.1 speakers for optimal listening experience

Notes

- *Some motherboards reserve the PCI Express x16 slots for video cards only. Use a x1 or x4 slot instead. For more information, consult the documentation of your motherboard.
- Other applications may have higher system requirements. For more information, consult the documentation of your application.

More Help

For the latest news and products for Sound Blaster, visit www.soundblaster.com. The site also includes information on making purchases, technical help, and the latest driver updates.

Using Creative Software AutoUpdate

Locating, downloading, and installing updates for your Creative products is now simpler and faster with the web-based Creative Software AutoUpdate system.

When you connect to Creative Software AutoUpdate via the Internet, the web site will analyze your computer system to determine what operating system (OS), language, and Creative products are installed in your system.

After the online analysis, you will be able to select from a list of only the most relevant software and driver updates. The files will then be retrieved and installed on your system for you.

To learn more about Creative Software AutoUpdate, visit www.soundblaster.com/support.

Notes

- First-time users of Creative Software AutoUpdate may be prompted to authorize the download of a browser component required for system inspection. Ensure that the content is signed by Creative Labs, Inc., then click the **Yes** button.
- Ensure that all your Creative products are connected and installed on the same computer running Creative Software AutoUpdate.

About Your Hardware

For instructions on installing your Sound Blaster Z-Series, and any additional accessories, consult the Quick Start leaflet.

To learn more about your product, consult the following sections:

- Your Sound Blaster Z-Series Audio card
- Audio Control Module

Notes

Actual products may differ slightly from those shown in this chapter.

Your Sound Blaster Z-Series Audio card

Your Sound Blaster Z-Series audio card has the jacks and connectors below to enable the attachment of a wide variety of devices.

SB1502

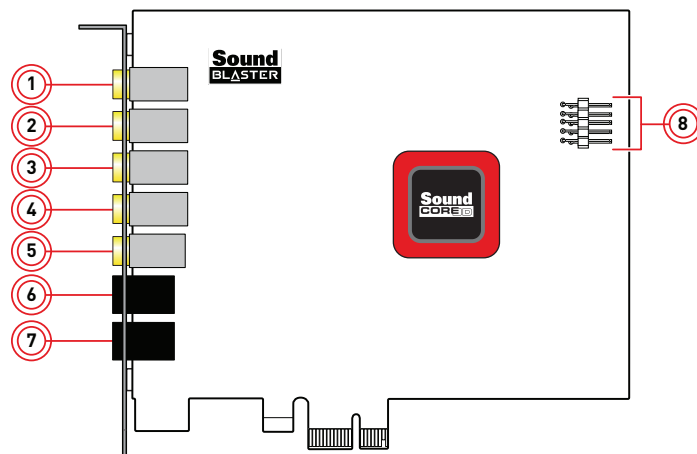

SB1500 / SB1506

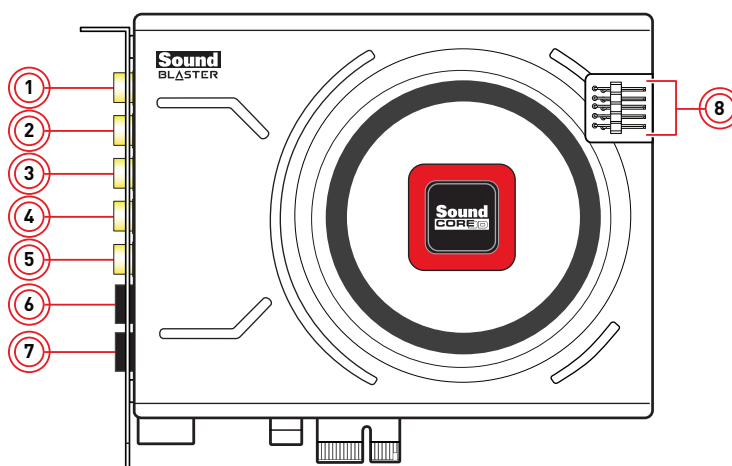

	Jack or Connector	Description
1.	Line In/Microphone In jack	Connects to line-level sources (for example, MP3 players) or microphones with a 3.5mm (1/8-inch) plug.
2.	Headphone jack	Connects to stereo headphones with a 3.5mm (1/8-inch) plug.
3.	Line Out 1 jack (Front L/R)	Connects to the Front Left and Front Right inputs on powered analog speakers or an A/V receiver.
4.	Line Out 2 jack (Rear L/R)	Connects to the Rear Left and Rear Right inputs on powered analog speakers or an A/V receiver.
5.	Line Out 3 jack (Center/Subwoofer)	Connects to the Front Center and Subwoofer inputs on powered analog speakers or an A/V receiver.
6.	Optical S/PDIF Out jack	Connects to recording devices with optical connectors (for example, Digital Audio Tape recorders, MiniDisc recorders or external hard disk recorders).
7.	Optical S/PDIF In jack	Connects to playback devices with optical connectors (for example, Digital Audio Tape players, MiniDisc players or DVD players).
8.	Front Panel Header Audio connector	Connects to one end of the Intel Front Panel Audio cable (available separately). See Front Panel Header Audio Connector for specifications.

Note:

Toggle to select the appropriate input device (for example, Microphone or Line-In) from the Sound Blaster Z-Series Control Panel. Refer to Sound Blaster Z-Series Control Panel Mixer Settings for more information.

Audio Control Module

An external ACM (Audio Control Module) provides a built-in beamforming microphone and microphone/headphone I/O connections.

Note:

The ACM accessory is bundled with Sound Blaster Zx only.

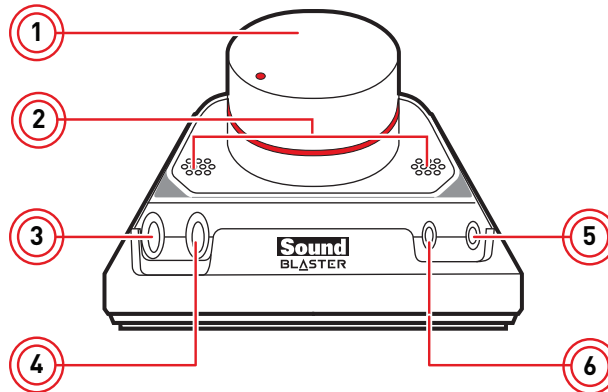

	Jack, Connector or Component	Description
1.	Volume Control Knob	Controls the playback volume of the sound card.
2.	Beamforming Microphone	Built-in Sound Blaster Beamforming Microphone
3.	6.3mm Microphone In jack	Connects to line-level sources (for example, MP3 players) or microphones with a 6.3mm plug.
4.	6.3mm Headphone jack	Connects to stereo headphones or headsets with a 6.3mm plug.
5.	3.5mm Microphone In jack	Connects to line-level sources (for example, MP3 players) or microphones with a 3.5mm (1/8-inch) plug.
6.	3.5mm Headphone jack	Connects to stereo headphones or headsets with a 3.5mm (1/8-inch) plug.

Note:

The 6.3mm Microphone In jack takes priority over the 3.5mm Microphone In jack.

When connected to the Sound Blaster Z-Series, the built-in beamforming microphone features CrystalVoice technologies which is designed to deliver crystal clear vocal fidelity in multiplayer games, online chats and video conferencing. It also enhances voice communications for popular VoIP solutions. Voice effects can be controlled using the Sound Blaster Z-Series Control Panel. Simply toggle between your headphone and speakers system with a flip of a switch in the control panel.

The options of 3.5mm and 6.3mm Microphone and Headphone jacks let you have choices of your own on which headset or microphone to be used for recording, and audiophile grade connection through the gold-plated jacks on the ACM and Sound Blaster Zx.

The Volume Control knob on the ACM controls the volume output to your headphones, giving you quick control over the audio level from your games or music.

Note:

The ACM Volume Control Knob allows you to adjust headphone levels conveniently based on the maximum level set by your computer's master volume control. We recommend that you determine the desired maximum volume on your computer before using the ACM.

Connecting Speakers and Headphones

The connectors and associated components shown here may be different from that of your speaker system. Consult the documentation of your speaker system to identify similar input connectors. You can upmix your stereo sources (for example, CD Audio, MP3, WMA, MIDI and Wave) to enjoy multi-channel sound on your speakers or headphones.

To learn how to connect different types of speaker systems to your audio card, consult the following sections:

- Connecting Analog Speaker Systems
- Connecting Digital Speaker Systems
- Connecting Home Theater Systems
- Connecting Headphones and Headsets
- Connecting Audio Control Module

For tips on how to arrange your speakers, consult Positioning Your Speakers.

For a list of supported Creative speaker systems or interactive help on speaker connectivity, visit www.soundblaster.com.

Note

- Actual products may differ slightly from those shown in this chapter.
- Select the correct speaker setup or headphone option in the Sound Blaster Z-Series Control Panel to get the best experience. For more information, refer to their respective Online Help.
- The cables shown in this chapter may be bundled with your peripheral or are available separately from www.creative.com.
- For more information on the Creative peripherals mentioned in this chapter, visit www.creative.com.

Positioning Your Speakers

Good speaker placement is crucial to getting optimal performance from your audio system and achieving an enhanced listening experience. Below are our recommendation for 5.1 channel speakers.

For detailed speaker placement tips, consult the documentation of your speaker system.

For 5.1 channel speakers:

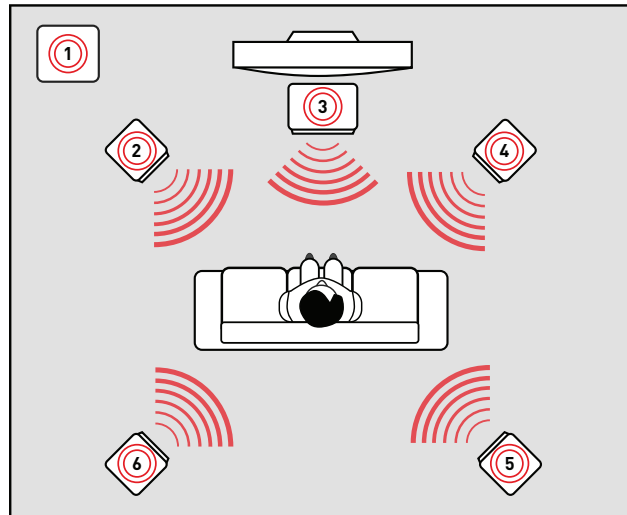

	Speaker Component
1.	Subwoofer
2.	Front left
3.	Front Center
4.	Front Right
5.	Rear Right
6.	Rear Left

Connecting Analog Speaker Systems

Your audio card supports analog speaker systems of up to 5.1 channels. To learn more about connecting different channel speaker systems, consult the following sections:

- 2.1 channel analog speakers
- 5.1 channel analog speakers

2.1 channel analog speakers

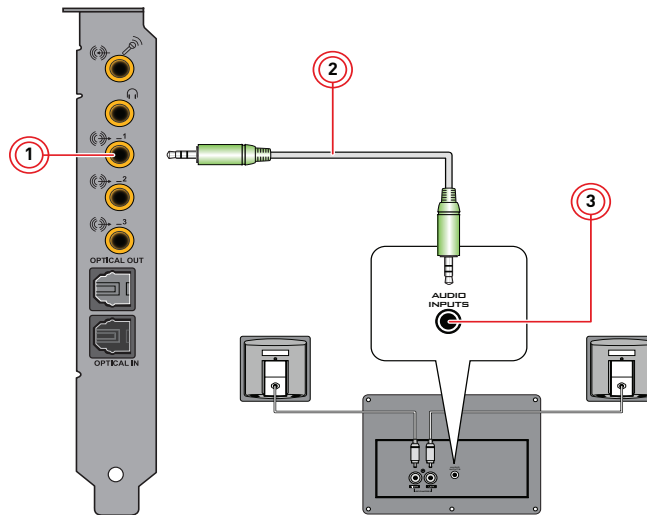

	Jack, Connector or Cable
1.	Line Out 1 jack (Front L/R)
2.	2 channel audio cable (available separately)
3.	Audio Input jack

5.1 channel analog speakers

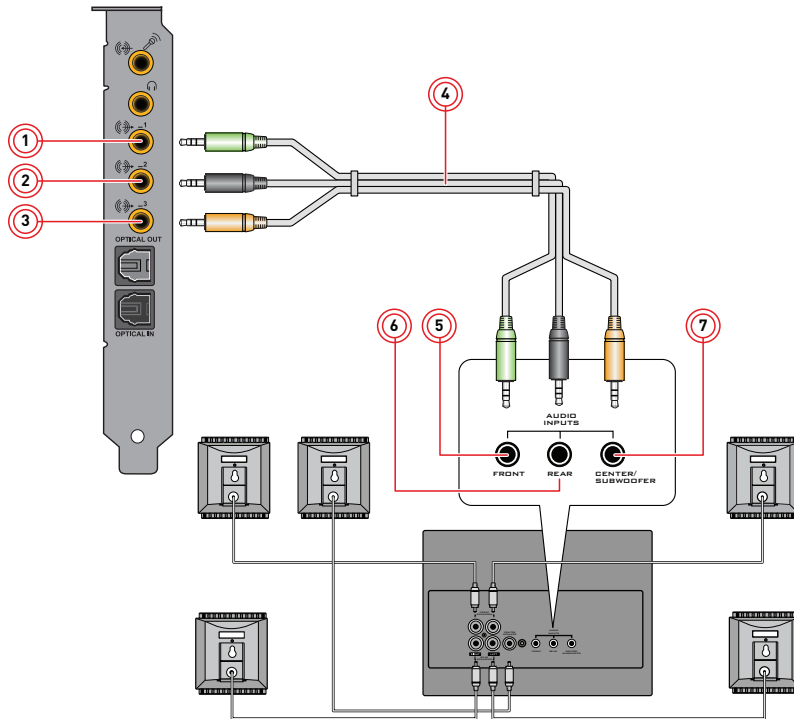

	Jack, Connector or Cable
1.	Line Out 1 jack (Front L/R)
2.	Line Out 2 jack (Rear L/R)
3.	Line Out 3 jack (Center/Subwoofer)
4.	5.1 channel audio cable (available separately)
5.	Front (Audio Input) jack
6.	Rear (Audio Input) jack
7.	Center/Subwoofer (Audio Input) jack

Connecting Digital Speaker Systems

Your Sound Blaster Z-Series comes with an Optical S/PDIF Out jack which allows you to connect your digital speaker system. Most digital speakers systems connect the audio card to the subwoofer or an external unit.

For more information on your digital speaker connections, consult the documentation of your digital speaker system.

Connecting your digital speakers to the Sound Blaster Z-Series

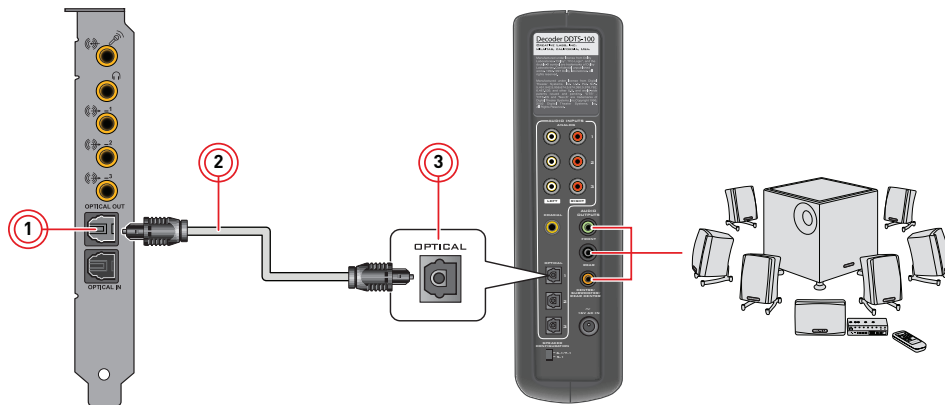

	Jack, Connector or Cable
1.	Optical S/PDIF Out jack
2.	Optical cable (available separately)
3.	Optical S/PDIF In jack

Connecting Home Theater Systems

Your Sound Blaster Z-Series comes with an Optical S/PDIF jack which allows you to connect your home theatre system. Most home theater systems connect the audio card to an A/V receiver.

For more information on your A/V receiver's speaker connections, consult the documentation of your A/V receiver.

Connecting your A/V receiver to the Sound Blaster Z-Series

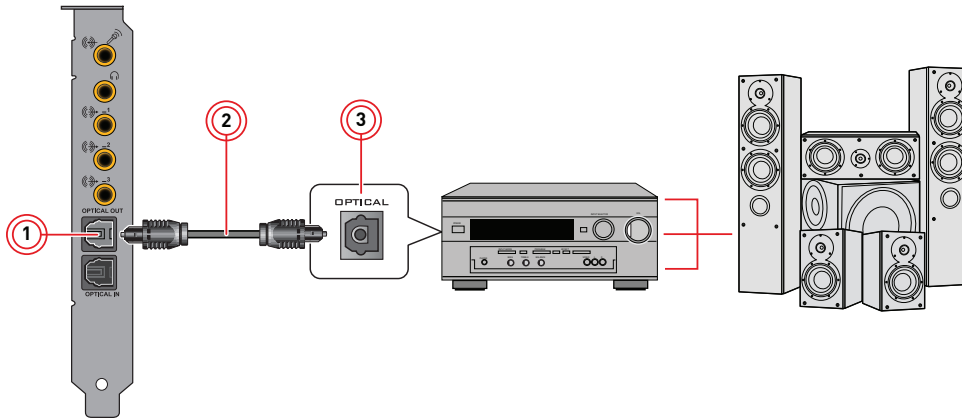

	Jack, Connector or Cable
1.	Optical S/PDIF Out jack
2.	Optical cable (available separately)
3.	Optical S/PDIF In jack

Connecting your A/V Receiver using Line Level inputs

If your A/V receiver supports multi-channel line-level inputs, you can connect them directly to your audio card's Line Out jacks instead of the Optical S/PDIF Out jack as shown below.

Connect to Line Out 1 (Front L/R)

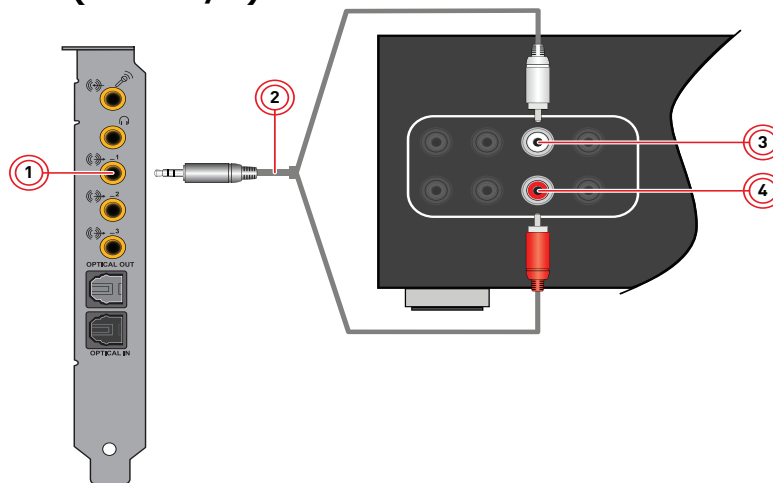

	Jack, Connector or Cable	Description
1.	Line Out 1 jack (Front L/R)	Connects to the Front left and Front Right jacks on your A/V receiver, using a 3.5mm (1/8-inch) stereo-to-RCA cable (available separately).
2.	3.5mm (1/8-inch) stereo-to-RCA cable (available separately)	Connects your audio card and A/V receiver.
3.	Front Right jack	Connects to the Line Out 1 jack on your audio card, using a 3.5mm (1/8-inch) stereo-to-RCA cable (available separately).
4.	Front Left jack	Connects to the Line Out 1 jack on your audio card, using a 3.5mm (1/8-inch) stereo-to-RCA cable (available separately).

Connect Line Out 2 (Rear L/R)

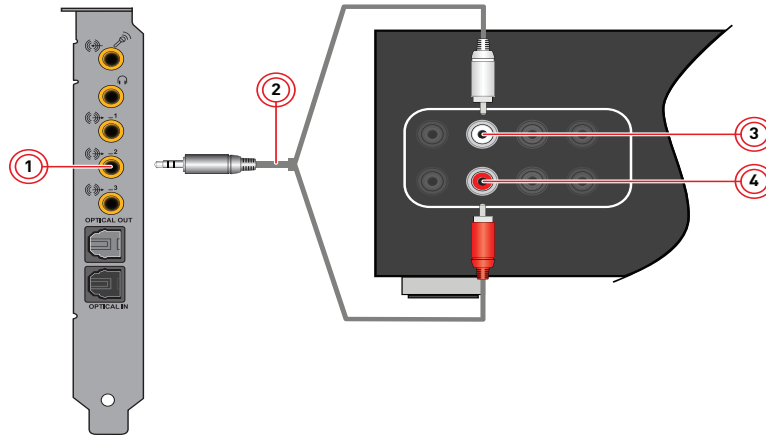

	Jack, Connector or Cable	Description
1.	Line Out 2 jack (Rear L/R)	Connects to the Rear Left and Rear Right jacks on your A/V receiver, using a 3.5mm (1/8-inch) stereo-to-RCA cable (available separately)
2.	3.5mm (1/8-inch) stereo-to-RCA cable (available separately)	Connects your audio card and A/V receiver.
3.	Rear Right jack	Connects to the Line Out 2 jack on your audio card, using a 3.5mm (1/8-inch) stereo-to-RCA cable (available separately).
4.	Rear Left jack	Connects to the Line Out 2 jack on your audio card, using a 3.5mm (1/8-inch) stereo-to-RCA cable (available separately).

Connect Line Out 3 (Center/Subwoofer)

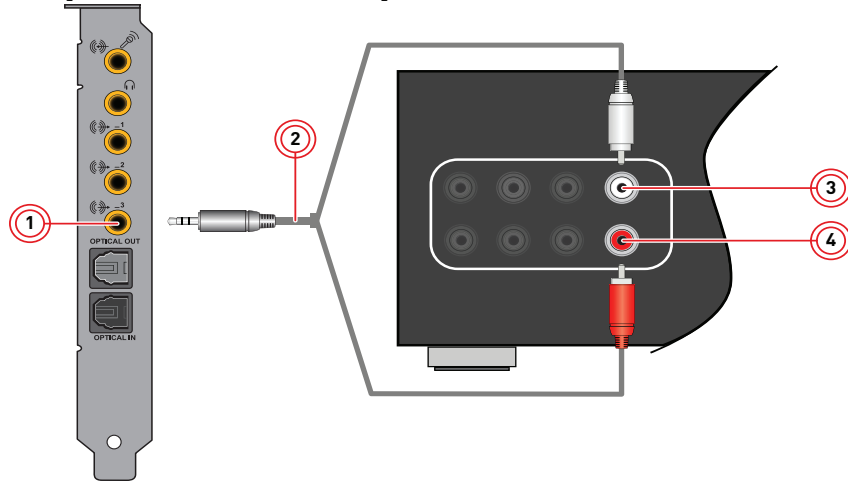

	Jack, Connector or Cable	Description
1.	Line Out 3 jack (Center/Subwoofer)	Connects to the Center and Subwoofer jacks on your A/V receiver, using a 3.5mm (1/8-inch) stereo-to-RCA cable (available separately)
2.	3.5mm (1/8-inch) stereo-to-RCA cable (available separately)	Connects your audio card and A/V receiver.
3.	Subwoofer jack	Connects to the Line Out 3 jack on your audio card, using a 3.5mm (1/8-inch) stereo-to-RCA cable (available separately).
4.	Center jack	Connects to the Line Out 3 jack on your audio card, using a 3.5mm (1/8-inch) stereo-to-RCA cable (available separately).

Connecting Headphones and Headsets

Do not listen to audio on your headphones or headsets at high volumes for prolonged periods of time as hearing loss may result.

Connecting your headphones and headsets to the Sound Blaster Z-Series

For headphones:

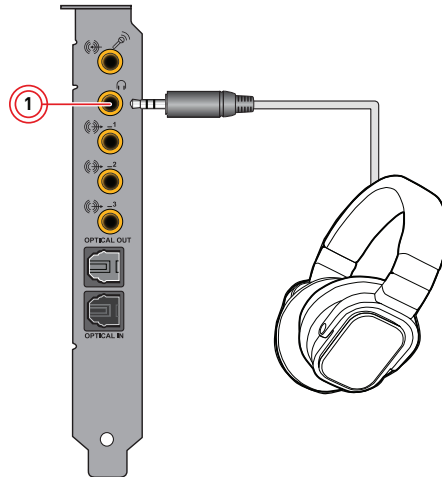

	Jack, Connector or Cable	Description
1.	Headphone jack	Connects to stereo headphones with a 3.5mm (1/8-inch) plug.

For headsets:

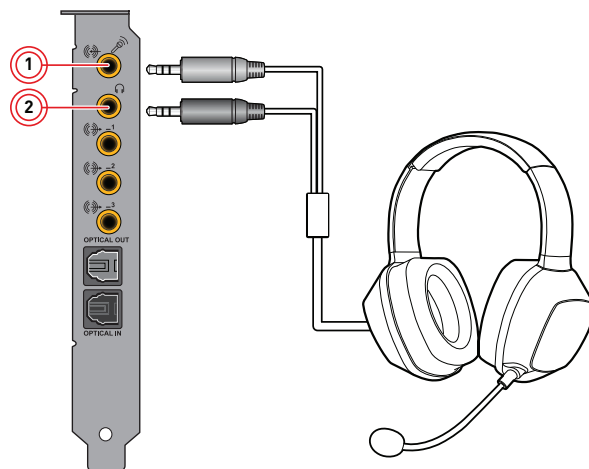

	Jack, Connector or Cable	Description
1.	Line In/Microphone In jack	Connects to the 3.5mm (1/8-inch) microphone plug of your headset.
2.	Headphone jack	Connects to stereo headphones with a 3.5mm (1/8-inch) plug.

Connecting Audio Control Module

The ACM accessory is bundled with Sound Blaster Zx only.

Connecting your ACM to the Sound Blaster Z-Series

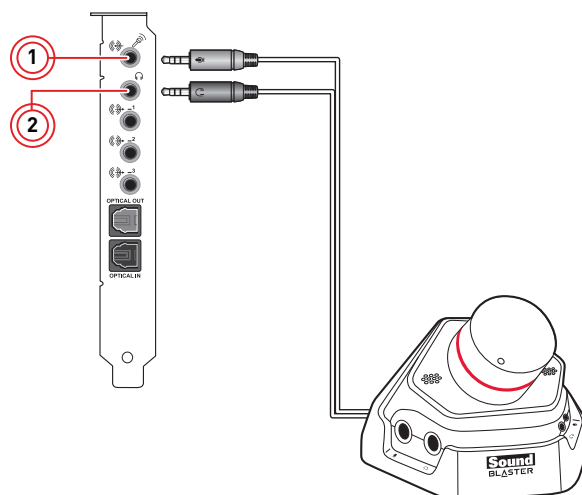

	Jack, Connector or Cable	Description
1.	Line In/Microphone In jack	Connects to the 3.5mm (1/8-inch) microphone plug of your ACM.
2.	Headphone jack	Connects to your ACM with a 3.5mm (1/8-inch) plug.

Connecting your headphones and headsets to the ACM

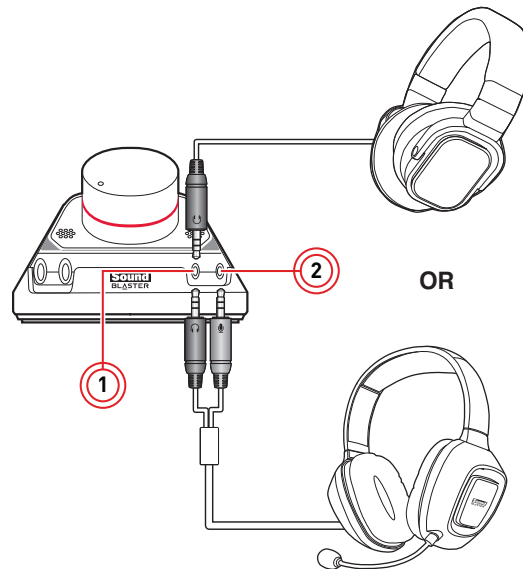

	Jack, Connector or Cable	Description
1.	3.5mm Headphone jack	Connects to stereo headphones or headsets with a 3.5mm (1/8-inch) plug.
2.	3.5mm Microphone In jack	Connects to line-level sources (for example, MP3 players) or microphones with a 3.5mm (1/8-inch) plug.

Note:

When two headphones are being connected to the 6.3mm and 3.5mm Headphone jacks simultaneously, you will be able to hear both headphones with the same output.

However, the Microphone In jacks on the ACM follow the below priority sequence:

- Priority 1: 6.3mm Microphone In jack
- Priority 2: 3.5mm Microphone In jack
- Priority 3: Built-in Beamforming Microphone

For example, when user plugs in external microphones to both 6.3mm and 3.5mm Microphone In jacks, the 6.3mm Microphone In jack will take priority over the 3.5mm Microphone In jack and the built-in Beamforming Microphone. However, when no microphone is connected to all Microphone In jacks, the built-in Beamforming Microphone will function.

Installing and Uninstalling Software

To take full advantage of your Sound Blaster Z-Series audio card, you need to install device drivers and applications. At times, you may also need to uninstall some or all of the device drivers and applications to correct problems, change configurations, or upgrade outdated drivers or applications. To learn how to do so in all supported Windows operating systems, consult the following sections:

- Uninstalling Drivers and Applications
- Installing Drivers and Applications

Uninstalling Drivers and Applications

Before you begin, close all running audio applications. Applications that are still running during uninstallation will not be removed.

For Windows 7:

1. Click **Start > Control Panel > Uninstall a Program**.
2. Select the **Sound Blaster Z-Series** entry.
3. Click the **Uninstall** button or option.
If the **User Account Control** dialog box appears, click the **Continue** button.
4. Click the **Yes** button.
5. When prompted, restart your computer.

For Windows 8:

1. At the right toolbar, click **Settings > Control Panel > Uninstall a Program**.
2. Select the **Sound Blaster Z-Series** entry.
3. Click the **Uninstall** button or option.
4. Click the **Yes** button.
5. When prompted, restart your computer.

To complete the uninstallation, you will also need to remove the following components:

- Dolby Digital Live Pack
- DTS Connect

To remove Dolby Digital Live:

Note

Carry out the following steps ONLY IF there are no other Creative applications on your system that requires the Dolby Digital Live encoder.

For Windows 7:

1. Click **Start > Control Panel > Uninstall a Program**.
2. Select the **Dolby Digital Live Pack** entry.
3. Click the **Uninstall** button or option.
When the **Confirm Uninstall** dialog box appears, click the **OK** button.

For Windows 8:

1. At the right toolbar, click **Settings > Control Panel > Uninstall a Program**.
2. Select the **Dolby Digital Live Pack** entry.
3. Click the **Uninstall** button or option.

To remove DTS Connect:

Note

Carry out the following steps ONLY IF there are no other Creative applications on your system that requires the DTS Connect encoder.

For Windows 7:

1. Return to the **Start > Control Panel > Uninstall a Program** window.
2. Select the **DTS Connect** entry.
3. Click the **Uninstall** button or option.
When the **Confirm Uninstall** dialog box appears, click the **OK** button.

For Windows 8:

1. At the right toolbar, click **Settings > Control Panel > Uninstall a Program**.
2. Select the **DTS Connect** entry.
3. Click the **Uninstall** button or option.

After you have completed the steps above, you can install the original or updated device drivers and applications for Sound Blaster Z-Series. For instructions on installing the software, consult **Installing Drivers and Applications**.

Installing Drivers and Applications

Ensure that your audio card is installed before proceeding. For instructions on installing your audio card, consult your Quick Start leaflet.

After you have installed your audio card, turn on your computer. Windows automatically detects your audio card and searches for device drivers.

For Windows 7:

1. Insert the Installation CD into your CD or DVD drive.
Your CD should start automatically. If it does not, follow the steps below:
 - i. Click **Start > Computer**.
 - ii. Right-click the CD or DVD drive icon, and then click **Open AutoPlay**.
2. To complete the installation, follow the instructions on the screen.
If you encounter the following message, click **Install**.



3. When prompted, restart your computer.

For Windows 8:

1. Insert the Installation CD into your CD or DVD drive.
2. In a short while, a drive icon will be displayed. Click on the icon, and then choose **Run setup.exe**.
If you do not see the drive icon, follow the steps below:
 - i. Right-click on the background of the Windows start screen, and then click **All apps**.
 - ii. Click **Computer**.
 - iii. Right-click the CD or DVD drive icon, and then click **Open AutoPlay**.
3. To complete the installation, follow the instructions on the screen.
If you encounter the following message, click **Install**.



4. When prompted, restart your computer.

Using Your Sound Blaster Z-Series

Your Sound Blaster Z-Series works seamlessly with many external devices to perform different tasks. To learn more about these tasks and how to connect additional devices, consult the following sections:

- Playing Games
- Watching DVDs
- Playing / Recording Music
- Creating Music
- Chatting / Gaming

Note

- Actual products may differ slightly from those shown in this chapter.
- The cables shown in this chapter may be bundled with your peripheral or are available separately from www.creative.com.
- For more information on the Creative peripherals mentioned in this chapter, visit www.creative.com.

Playing Games

Your Sound Blaster Z-Series is specially designed to enhance audio in games using Creative's cutting edge audio technologies. Playing games will be more exhilarating than ever before!

To learn more about the following audio technologies, visit www.soundblaster.com.

EAX ADVANCED HD

Make your games come alive with EAX[®] ADVANCED HD™ and immerse yourself in worlds that their creators envisioned!

Hear multiple audio effects being played simultaneously, and precise environment settings applied to them to create a life-like environment and heighten the sense of realism.

Each effect is also accurately positioned in its 3D environment, allowing you to tell where it is coming from relative to your location, and you will be able to discern where your teammates and enemies are using only these audio cues.

EAX ADVANCED HD is a weapon that will give you the competitive edge, especially in multiplayer games.

Creative ALchemy

Creative ALchemy is a powerful tool that restores the audio for a DirectSound[®] 3D game running on Windows 7 or Windows 8 to its former glory - in full surround sound with hardware accelerated audio mixing, sampling rate conversion and EAX effects.

Dolby Digital Live

Dolby Digital Live is a real-time encoding technology from Dolby Laboratories that converts any audio signal into a Dolby Digital bitstream for transport and playback through your home theatre or digital speaker system.

Transform your gameplay into an exciting and realistic experience using Dolby Digital Live. Audio cues and effects that follow the onscreen action are reproduced, immersing you in 5.1 channel surround sound that puts you at the center of the action.

To learn more about Dolby Digital Live, visit www.dolby.com.

DTS Connect

DTS Connect is a real-time encoding technology from DTS, Inc. for interactive media and is only available on the PC platform. It converts any audio signal on the computer into 5.1 channel DTS format and transports it via a single digital cable.

With Dolby Digital Live or DTS Connect, a single digital cable is all that is needed to connect your computer to your home theatre system, simplifying the setup and eliminating the confusion of multiple cables.

To learn how to connect your A/V receiver or digital speaker system to your audio card, consult the following sections:

- Connecting Home Theater Systems
- Connecting Digital Speaker Systems

Watching DVDs

Your DVDs are encoded with Dolby Digital audio technologies, which have to be decoded to enjoy multi-channel audio on your 5.1 speaker systems.

Decoding with a software DVD player

You can use a software DVD player to decode Dolby Digital or DTS encoded signals from your DVDs, and output multi-channel audio through your audio card to your speakers.

To do so, you need to install a software DVD player such as PowerDVD or WinDVD (latest version recommended).

Decoding with an external decoder

You can pass Dolby Digital or DTS encoded signals from your DVDs through your audio card to an external decoder (for example, an A/V receiver), and output multi-channel audio to your 5.1 speaker systems. Some digital speaker systems are also capable of decoding Dolby Digital or DTS encoded signals.

To learn more, consult the documentation of your external decoder or digital speaker system.

To learn how to connect your A/V receiver or digital speaker system to your audio card, consult the following sections:

- Connecting Home Theater Systems
- Connecting Digital Speaker Systems

Playing / Recording Music

You can play music from, and/or record music to external devices (for example, Digital Audio Tape player/recorder) by connecting them to your Sound Blaster Z-Series.

Connecting your external device to the Sound Blaster Z-Series

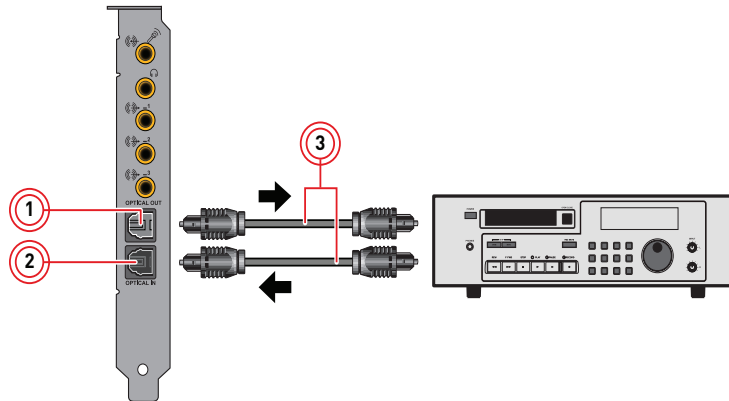

	Jack, Connector or Cable	Description
1.	Optical S/PDIF Out jack	Connects to recording devices with optical connectors (for example, DAT recorders, MD recorders or external hard disk recorders).
2.	Optical S/PDIF In jack	Connects to playback devices with optical connectors (for example, DAT players, MiniDisc players or DVD players).
3.	Optical cable (available separately)	Connects the playback or recording device to your Sound Blaster Z-Series.

Creating Music

You can set up a home music studio using your Sound Blaster Z-Series.

Put together your own productions consisting of multiple music tracks from a MIDI synthesizer or an electric guitar. Alternatively, connect your electric guitar using a pre-amp box to the Line In/Microphone In jack. Use a converter if your pre-amp box comes with a larger (for example, a 6.35mm (1/4-inch)) connector.

You can also connect a microphone to your Sound Blaster Z-Series.

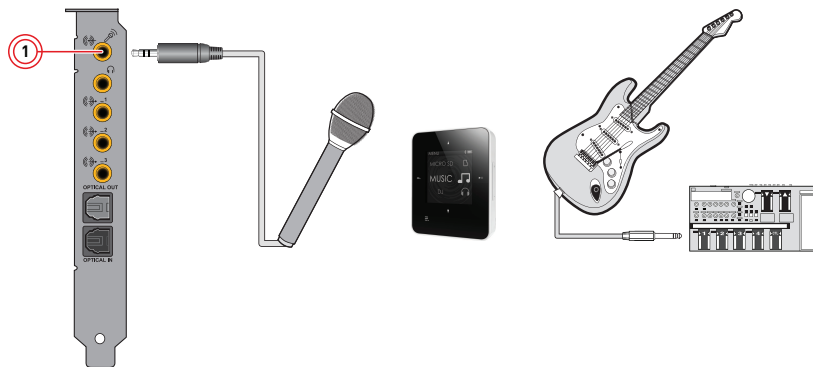

	Jack, Connector or Cable	Description
1.	Line In/Microphone In jack	Connects to line-level sources (for example, MP3 players) or microphones with a 3.5mm (1/8-inch) plug.

Chatting / Gaming

Your Sound Blaster Z-Series can also be connected to hands-free microphones or the Sound Blaster Beamforming Microphone, making over-the-Net chatting a hassle-free affair. Now you can enjoy clear voice chat for gaming and other online chatting purposes.

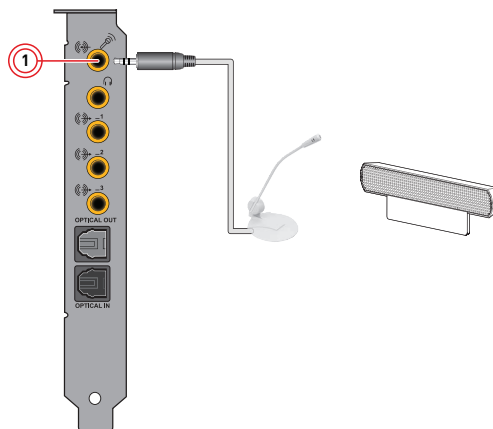

	Jack, Connector or Cable	Description
1.	Line In/Microphone In jack	Connects to microphones or the Sound Blaster Beamforming Microphone with a 3.5mm (1/8-inch) plug.

Using the Creative Software Suite

The following software is designed for you to access the basic as well as the advanced features of your audio card. We recommended that you familiarize yourself with their functions in order to make full use of the rich features of your audio card.

To learn more about each application, consult its Online Help. Depending on the application, you can do this by clicking  on the toolbar of the application, or selecting **Help Topics** from the **Help** menu.

Applications

- Sound Blaster Z-Series Control Panel
- Creative ALchemy
- Creative Software AutoUpdate
- Creative Host OpenAL / EAX5.0 HD
- Creative Product Registration
- Creative Diagnostics
- Dolby Digital Live encoder
- DTS Connect encoder
- Sound Blaster Speaker Setup

Various other bonus Creative applications are also compatible for your audio card. Visit www.creative.com/support and navigate to the relevant product page to view and download these applications.

Note

- The applications included with your audio card may differ from those described here. Your audio card may also come with third party applications.
- Some applications are available for certain operating systems or certain card models only.
- The color of Sound Blaster Z-Series Control Panel may differ for different sound cards.

Sound Blaster Z-Series Control Panel

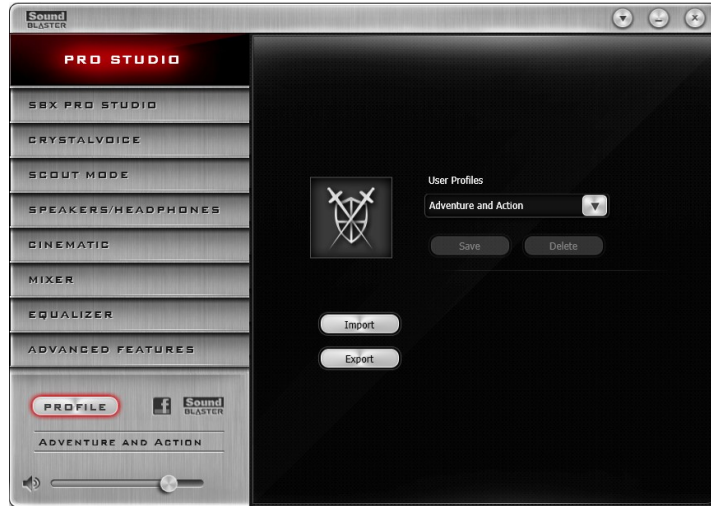

Managing Your Profiles

Click the **PROFILE** button to display the Profiles pane.

Activate a profile by clicking the  and selecting it from the list.

Click **Save** to save all settings to the current profile or create a new profile. Click **Delete** to delete the active profile.



Sharing Profiles

You can export your custom settings and share them with others, or import other gamers' custom settings.

Customizing Your Avatar

You can customize the avatar for each profile. Double-click the current avatar to open the selection window. You can either select an avatar from the list or click **Browse** to select your own image file to be used as the avatar.

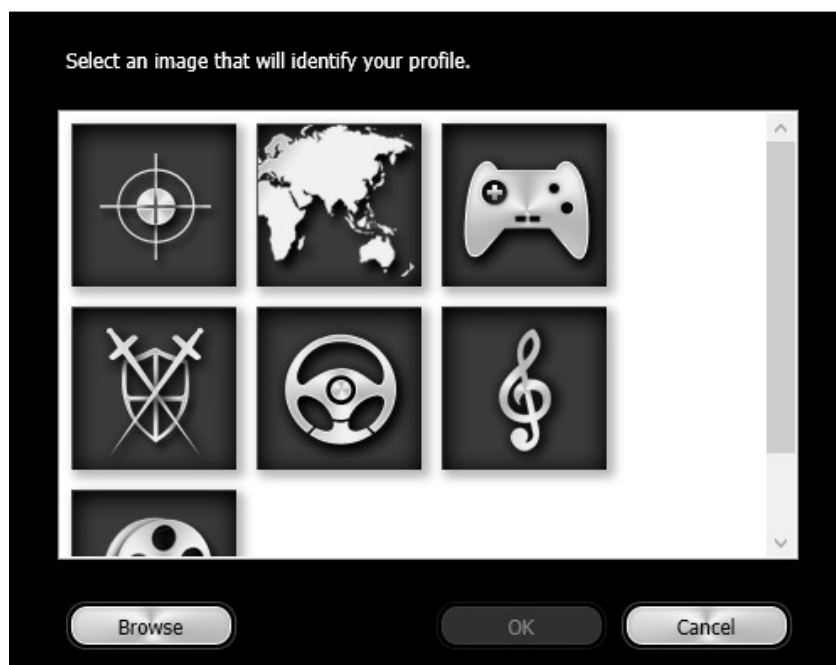

Adjusting Your Master Volume Settings

Drag the master volume slider to adjust the volume level. You can mute/unmute the volume by clicking the speaker icon.



Configuring Your Software Settings

Click each feature to access its settings page. More information on each feature can be found in their respective sections in this manual.

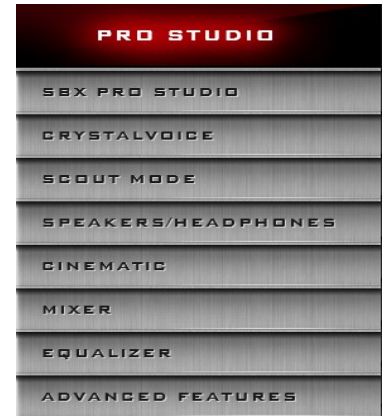

Configuring Your General Settings

You can change the language settings or restore settings to their default values. You can also check for software updates. Click  and configure various options from the list that displays including:



- "Options" - Enable the system to automatically check for software updates when your computer is online.
- Select whether the Sound Blaster Z-Series Control Panel is activated when Windows starts.
- Restore default settings.
- Select the audio playback device
- Select the supported software languages available for your system.
- Manually check for and update the software
- General information regarding your Sound Blaster Z-Series Control Panel software.



SBX Pro Studio Settings



1. SBX Pro Studio enhancements
Select to turn on or turn off each enhancement. You can hover your mouse cursor over each enhancement to display a brief explanation.
2. Enhancement Level sliders
Adjust the amount of enhancement to apply.
3. Audio Test controls
Play/Pause or Stop the demo video.

Enhancing Your Listening Experience

You can adjust the amount to apply for each enhancement by dragging its slider left to decrease or right to increase. To test the effects of the audio enhancements, click  and listen to the demo video.

- **SBX Pro Studio Surround** provides immersion control of sounds not just around you, but also above and below for a full 3D audio experience. Hear the natural sense of audio depth, spaciousness and stunning 3D surround effects from your audio content. Enjoy an unbelievably true-to-life audio experience, whether it's over stereo speakers or headphones.
- **SBX Pro Studio Crystalizer** restores the dynamic range that is lost when iTunes and MP3 music gets compressed. This makes the music sound as good as the artist originally intended, and adds an enhanced level of realism for movies and games.
- **SBX Pro Studio Bass** fills in the low frequency tones and gives the extra impact for a better entertainment experience. It dramatically improves the sound experience without a subwoofer.
- **SBX Pro Studio Smart Volume** addresses the problem of abrupt volume level changes during playback and between songs by automatically and continuously measuring volume, and intelligently applying gain and attenuation to compensate for those changes.
- **SBX Pro Studio Dialog Plus** enhances the voices in movies for clearer dialog, allowing the listener to hear the dialog over the rest of the soundtrack and over ambient noise in the listening environment.

CrystalVoice Settings



1. First select the recording device.
2. Next, turn on CrystalVoice and select to turn on or turn off each of the available enhancements.

Having Fun with CrystalVoice

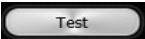
After configuration, click  and speak into your microphone to hear how your voice sounds with CrystalVoice applied. Readjust as desired.

- **CrystalVoice FX** enables the speaker's voice to be altered with a variety of effects, which can be used to enhance the tone of the speaker's voice, create interesting accents or to sound like a completely different person.
- **CrystalVoice Smart Volume** automatically adjusts the loudness of the speaker's voice to maintain a consistent volume level. This makes it convenient for the speaker to converse normally, regardless of whether the speaker is close to or far away from the microphone.
- **CrystalVoice Noise Reduction** enables the speaker to be heard clearly over background noise by constantly monitoring the environment and eliminate the unwanted noise that interferes with the conversation.
- **CrystalVoice Acoustic Echo Cancellation** eliminates echoes and enables the speaker to listen to the other party clearly. Echoes are a common problem present in voice communication systems that disrupts conversations by making it difficult to hear the other party.
- **CrystalVoice Focus** creates a zone and suppresses noise outside it to enable the speaker within to be heard with amazing clarity. Multiple microphones are used to focus, enhance the speaker's voice, and eliminate sounds outside the zone.

Scout Mode

Scout mode transforms your hearing and enables you to hear your opponents from further away, giving you a distinct tactical advantage in combat.

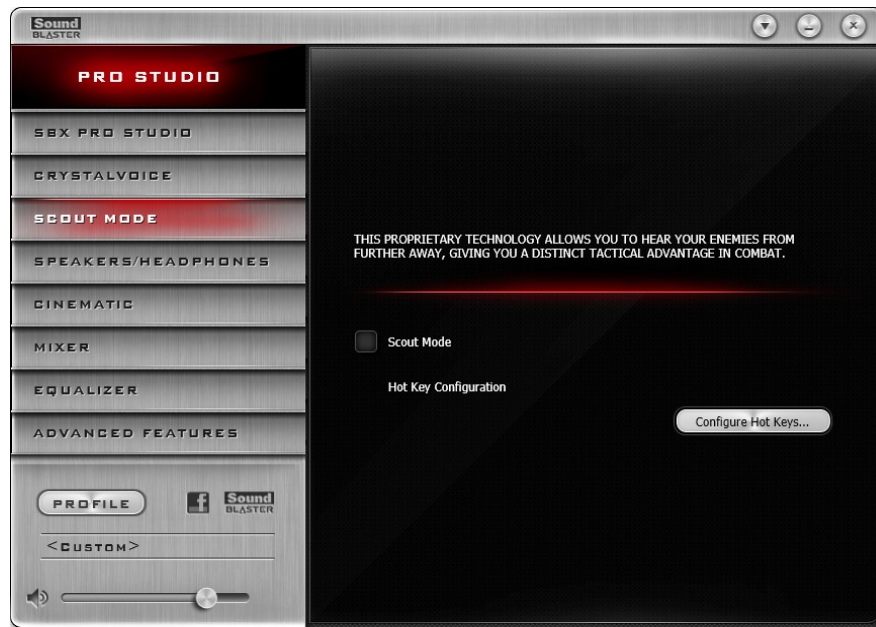

1. Scout mode

Select to turn on or off Scout mode.

Click  to configure hotkeys for turning on and turning off Scout mode.

Speakers/Headphones Settings



1. Switch between Speakers or Headphones mode.
2. Speakers / Headphones Configuration
Select your current physical speaker or headphone configuration.

Notes:

Stereo Direct is an option for direct playback to stereo speaker channel sampled at 192kHz. The following features will not be applied to this playback:

- SBX Pro Studio suite of audio enhancements
- DTS Connect
- Dolby Digital Live
- Equalizer

Testing Your Audio Playback

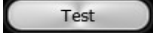
Select the appropriate configuration based on your setup, then click  to hear a sample audio clip being played back through your setup.

Cinematic Settings



1. Encoder settings

Select "No Encoder" if you wish to turn off encoding or select "Dolby Digital Live" or "DTS Connect" to turn on the respective encoders.

Setting up DTS Connect



Under DTS Connect, select or unselect the option "DTS Neo:PC" and configure its various settings according to your audio playback needs. To learn more about DTS Connect, please visit www.dts.com.

Mixer Settings



1. Volume sliders
Adjust the playback and recording volume for your various inputs and outputs.
2. Input Device
Select the input device source from the following analog sources: Front Microphone, Rear Microphone or Rear Line-in. Only one source can be active at any one time.

Adjusting Your Mixer Settings

Slide the volume level sliders right to increase and left to decrease. Click the  icon to mute/unmute the input/output. You can click the  icon to adjust the settings for your input/output.

Selecting the Input Device Source

Your audio card supports audio input from the following analog sources:

- Front Microphone (Intel HD Front Panel)
- Rear Microphone (Line In/Microphone In jack)
- Rear Line-in (Line In/Microphone In jack)

Only one of the above input sources can be active at any time. The Input Device configuration allows you to specify the input source you wish to activate.

Step 1: Launch the Sound Blaster Z-Series Control Panel from your Windows start menu.

Step 2: Select "Mixer" to view the Mixer configuration interface.

Step 3: Click the Input Device button and select the appropriate input source.

For example, if you would like to record from a microphone connected to the Intel HD Front Panel, select "Front Microphone" as shown in the figure below.

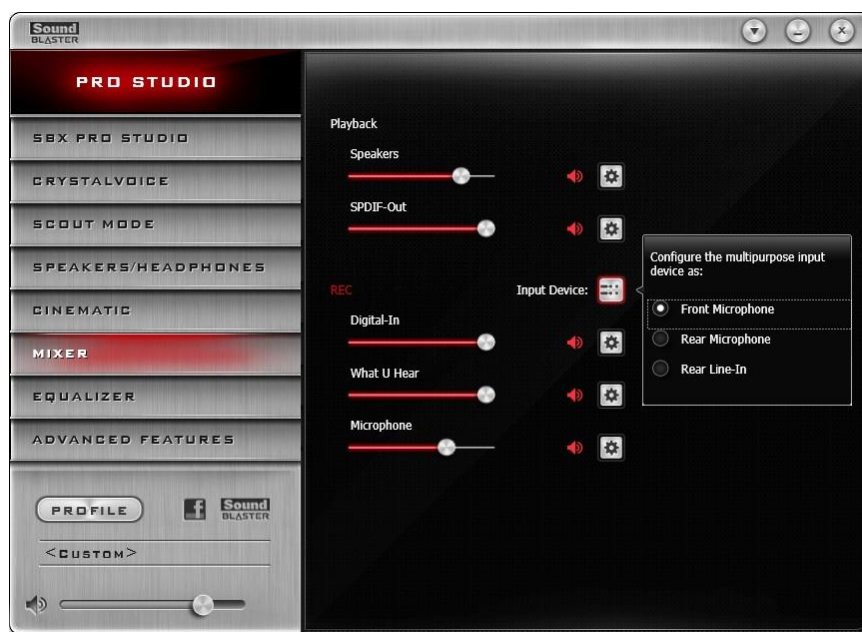

Equalizer Settings

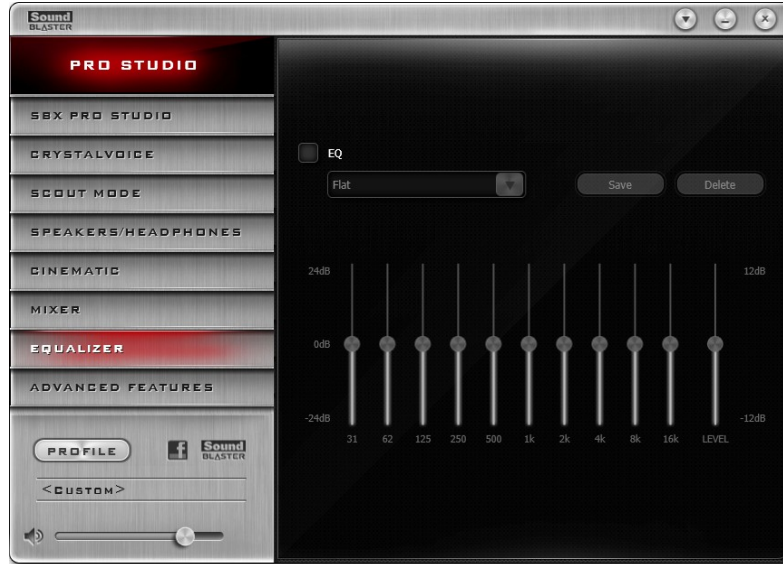

1. EQ presets
Select an equalizer preset to apply to your audio.
2. EQ sliders
Adjust the equalizer settings.

Customizing Your EQ Settings

Select the EQ checkbox to enable this feature, then click the EQ drop-down arrow and select a preset from the list.

Selecting a preset will move the EQ sliders to the appropriate values. You can then adjust the equalizer setting by dragging the sliders up or down to the desired level. Click  to save the new configuration as a new preset.

Note

The list of default EQ presets cannot be deleted or overwritten.

Advanced Features Settings

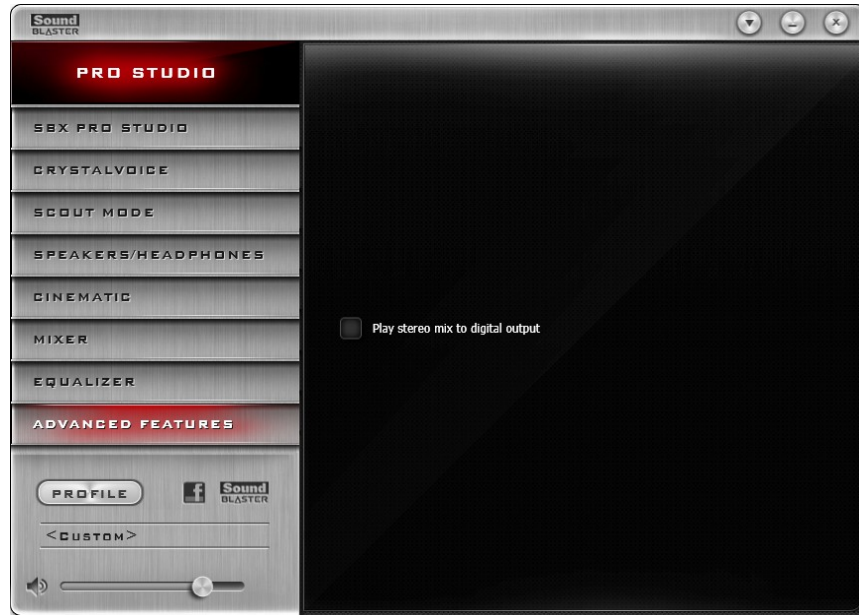

1. Play stereo mix to digital output
Select the checkbox to down mix the audio with its effects to a stereo PCM stream to be channeled to digital output.

Note

You must first select "Speaker" as the playback device to use this feature.

Using Your Audio Device

Playing Games

Your audio device is equipped with cutting edge audio technologies and software to enhance the audio in your games. SBX Pro Studio will elevate your gaming experience to the next level, allowing you to hear sound details in games you have never heard before!

For details on the various SBX Pro Studio enhancements and its configuration, please refer to SBX Pro Studio Settings.

Creative ALchemy

When configuring DirectSound®3D games on Windows 7 and Windows 8, the game loses its immersiveness and environmental effects due to changes in audio architecture.

To restore these effects and experience the full audio immersion, follow the steps below:

Enable Windows XP Compatibility Mode

1. Navigate to the folder where you have installed the game.
2. Right-click on the game's launcher and select **Properties**.
3. Select the **Compatibility** tab and select the **Compatibility Mode** checkbox.
4. Click the **Compatibility Mode** drop-down arrow and select **Windows XP (Service Pack 2)**, then click **OK**.

Enable the Game in Creative ALchemy

For Windows 7:

1. Click **Start > Programs or All Programs > Creative > ALchemy > Creative ALchemy**
2. The game should be detected automatically and appear in the left column.
3. Select the game and click  to move it to the right column.
4. Close the application.

For Windows 8:

1. At Windows Start screen, click **Creative ALchemy**
2. The game should be detected automatically and appear in the left column.
3. Select the game and click  to move it to the right column.
4. Close the application.

When you launch the game, you should hear the original effects.

Note

If the game is not detected, do the following:

1. *Navigate to the folder where you have installed the game.*
2. *Right-click on the game's launcher and select Run as administrator.*
3. *Exit the application and launch Creative ALchemy again. The game should now appear in the left column.*

Communicating with Voice over Internet Protocol (VoIP)

Use a headset with your audio device to enjoy outstanding acoustic performance in popular VoIP applications like Ventrilo® and TeamSpeak®. Hear and be heard clearly by teammates during multi-player games to get the tactical edge.

You can enhance such voice communications using CrystalVoice enhancements. For more details, please refer to CrystalVoice Settings.

Creating Your Audio 'Sweet Spot' with the SB Speaker Setup

Generally, for a 5.1 speaker configuration, there is an ideal speaker placement that allows you to position yourself in the audio sweet spot, giving you the best surround and audio pleasure possible. Please refer to Positioning Your Speakers or your speaker system documentation for details on the recommended placement.

Often, however, we may be unable to place our speakers ideally due to physical constraints such as room size and object placements etc. Hence, the Sound Blaster Z-Series audio card comes bundled with the Sound Blaster Speaker Setup application. Simply launch this application from the Sound Blaster Z-

Series Control Panel ( icon found in Speakers/Headphones settings), or your Windows start menu and adjust the settings to create a virtual speaker placement.

Speaker Configuration

Here you can configure your current speaker system and also conduct sound tests to check your setup.



Bass Management

Direct bass audio to your subwoofer using the various configuration options found in this tab. You can perform a base test to monitor for frequencies that drop as the tone sweeps from your front speakers to your subwoofer. Adjust as desired.

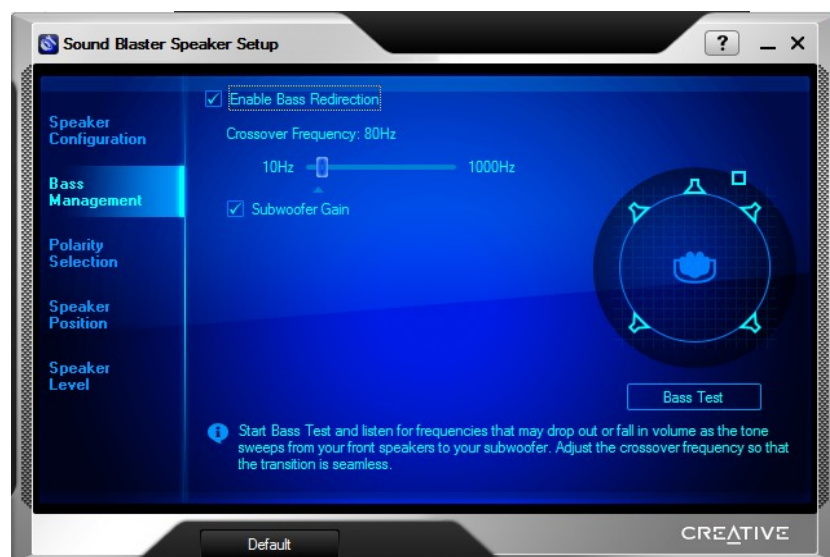

Polarity Selection

If you have an audio/video (A/V) receiver, your speakers must be wired appropriately (in-phased) in order to reproduce sound fields correctly. The Polarity Selection tab helps you correctly connect all negative and positive output terminals on the A/V receiver to the inputs on the speakers.

Click the Start button and follow the on screen procedure to check your the speaker wiring.



Speaker Position

This tab helps you to maximize your speakers' audio performance when you are unable to optimize your speaker positioning due to physical space constraints. You will need to specify:

- the distance between the ideal listening position and each of your speakers
- the angle of your speakers
- position of the Front Center Channel (if available), to compensate for its actual position either above or below the monitor.

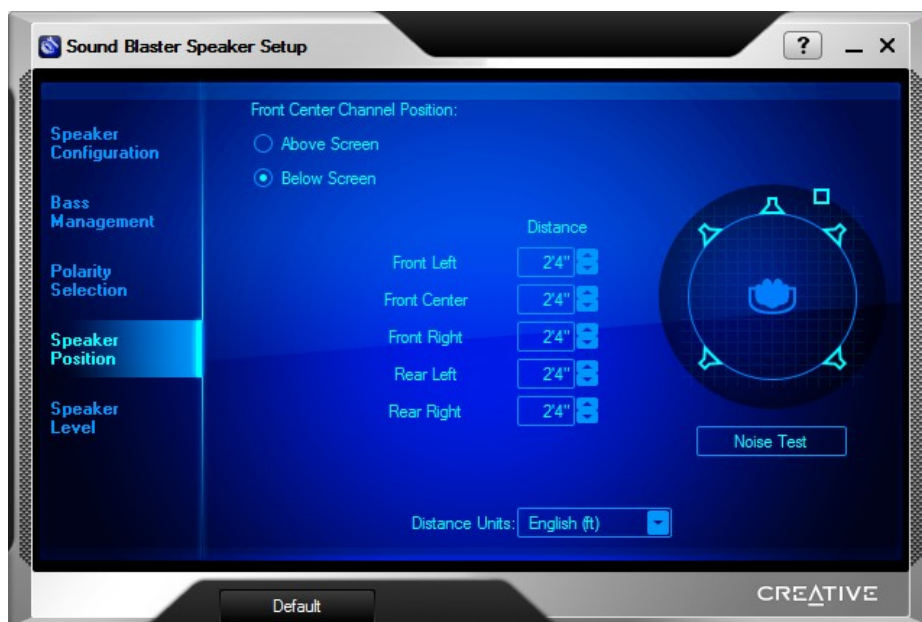

Speaker Level

This set of configurations enables you to achieve a balanced level for each speaker. Speaker level is affected mainly by the distance between the speaker and the listener.

Click the Level Test button and adjust the speaker level for each speaker accordingly.

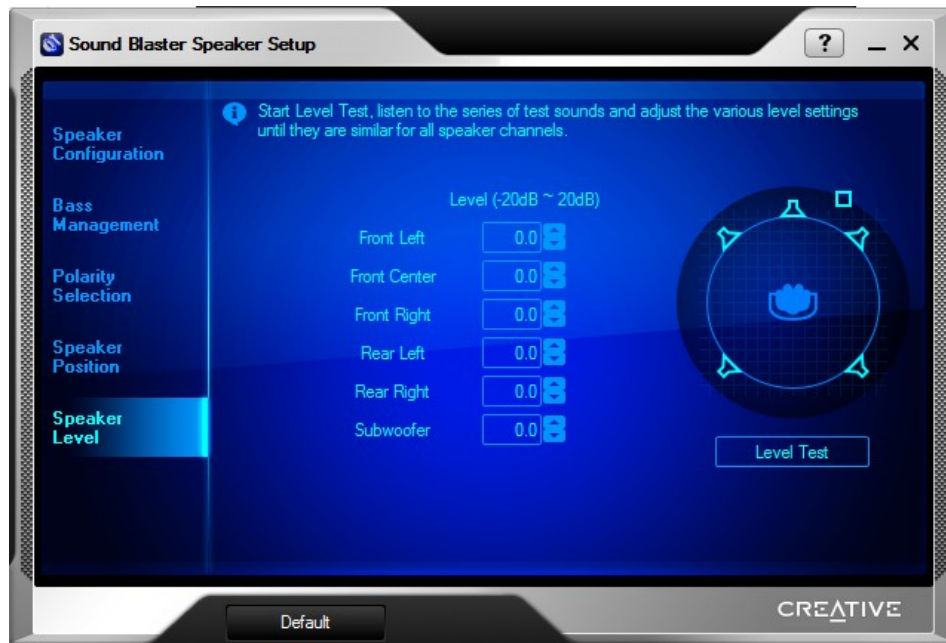

General Specifications

This section details the specifications of your Sound Blaster Z-Series audio card.

PCI Bus Mastering

- PCI Express Specification Version 1.1 compliant
- Bus mastering reduces latency and speeds up system performance

Sound Blaster Sound Core3D Audio Processor

- Advanced hardware accelerated digital effects processing
- Dedicated DSP capable of both time and frequency domain audio processing

Professional Digital Audio Processing

- 24-bit Analog-to-Digital conversion of analog inputs at up to 96 kHz sample rate
- 24-bit Digital-to-Analog conversion of digital sources to analog outputs
- 16-bit to 24-bit recording sampling rates: 44.1, 48 and 96 kHz
- Supports Sony/Philips Digital Interface (S/PDIF) format of up to 24-bit/96 kHz quality
- S/PDIF output at selectable sampling rate of 44.1, 48 or 96 kHz from Microsoft Control Panel
- S/PDIF output not available during playback of protected digital audio content authored with DRM (Digital Rights Management) technology

Note

Depending on your system configuration, output sampling frequencies may be available at 48 and 96 kHz.

Flexible Mixer Control

- Selectable input source from various audio sources for recording
- Adjustable master volume control
- Independent volume control

SBX Pro Studio Technology

- SBX Pro Studio Crystalizer
- SBX Pro Studio Surround
- SBX Pro Studio Bass
- SBX Pro Studio Dialog Plus
- SBX Pro Studio Smart Volume

Sound Blaster CrystalVoice Technology

- CrystalVoice Acoustic Echo Cancellation
- CrystalVoice Noise Reduction
- CrystalVoice Smart Volume
- CrystalVoice FX
- CrystalVoice Focus

Connectivity

This section details the connectivity of your Sound Blaster Z-Series audio card.

Sound Blaster Z-Series Audio Card

Audio Inputs

- One 3.5mm (1/8-inch) Line In jack for Analog Line In or Microphone In
- One Optical S/PDIF jack for Digital In

Audio Outputs

- One 3.5mm (1/8-inch) Headphone jack
- Three 3.5mm (1/8-inch) Line Out jacks for six channel analog audio output: Front Left, Front Right, Front Center, Subwoofer, Rear Left and Rear Right channels
- One Optical S/PDIF jack for Digital Out

Interfaces

- One 2 x 5 pin Front Panel Header for connection with Intel HD Front Panel Audio standard header

Front Panel Header Audio Connector

Connection Compatibility

- Intel HD Front Panel Audio standard only.
Not compatible with AC97 or Intel-compatible HD Front Panel Audio

Pin Configuration

Pin	Signal Name	Description
1	PORT 1L	Analog Port 1 - left channel (Microphone)
2	GND	Ground
3	PORT 1R	Analog Port 1 - right channel (Microphone)
4	PRESENCE#	Active low signal that signals BIOS that an Intel HD Audio dongle is connected to the analog header. PRESENCE# = 0 when an Intel HD Audio dongle is connected.
5	PORT 2R	Analog Port 2 - right channel (Headphone)
6	SENSE1_RETURN	Jack detection return for Front panel (JACK1)
7	SENSE_SEND	Jack detection sense line from the Intel HD Audio CODEC jack detection resistor network
8	KEY	Connector Key
9	PORT 2L	Analog Port 2 - left channel (Headphone)
10	SENSE2_RETURN	Jack detection return for front panel (JACK2)

Troubleshooting

This section provides solutions to problems you may encounter during installation or normal use. This includes:

- Problems with Digital Audio Devices
- Problems with Dolby Digital Live or DTS Connect
- Problems with Multiple Audio Devices
- Problems with Sound

If you have any other technical problems with this product, you can also consult our self-help tool "Knowledge Base" for online troubleshooting and solutions. Visit www.soundblaster.com and select your region.

Problems with Digital Audio Devices

Popping noises are heard during playback.

The DMA feature may not be enabled for your computer's drives.

To solve this problem:

For Windows 7:

1. Click **Start > Control Panel > Hardware and Sound > Device Manager**.
If the **User Account Control** dialog box appears, click the **Continue** button.
2. Double-click the **IDE ATA/ATAPI Controllers** icon.
3. For each ATA Channel in the list, right-click and select **Properties**.
4. Click the **Advanced Settings** tab and select the **Enable DMA** checkbox.
5. Click the **OK** button.

For Windows 8:

1. At the right toolbar, click **Settings > Control Panel > Hardware and Sound > Device Manager**. If the **User Account Control** dialog box appears, click the **Continue** button.
2. Double-click the **IDE ATA/ATAPI Controllers** icon.
3. For each ATA Channel in the list, right-click and select **Properties**.
4. Click the **Advanced Settings** tab and select the **Enable DMA** checkbox.
5. Click the **OK** button.

Problems with Dolby Digital Live or DTS Connect

Cannot enable Dolby Digital Live or DTS Connect.

Before enabling Dolby Digital Live or DTS Connect:

- Stop all audio playback through your selected output device. If not, Dolby Digital Live may not be enabled.

Dolby Digital Live / DTS Connect is not working for my applications and games.

To solve this problem:

- Set the Speakers option of your audio device as the default playback device in the settings menu of your applications and games, and in the Windows Sound Control Panel.

Note

If Dolby Digital Live or DTS Connect is enabled, only PCM audio and certain compressed audio (for example, MP3) can be played, which will be encoded by Dolby Digital Live or DTS Connect through your selected output device.

Problems with Multiple Audio Devices

If there are other audio cards on the system.

You may have an existing audio device installed in your computer. The audio device may be an audio card or an onboard audio chipset. Before you install your audio device, you are advised to disable or completely uninstall and remove your existing audio device. Operating multiple audio devices in your computer may introduce usability issues.

Alternatively, during the installation of your audio card, do the following:

- If your computer detects an installed Sound Blaster Audigy series, Sound Blaster Live! series or Sound Blaster PCI512 audio card, a message box recommending that you completely uninstall and remove the older audio device will appear. Click the **Yes** button and follow the instructions on the screen to complete the removal of the old audio device. Remove the old audio card from your computer.
- If your computer detects any other installed audio card, a message box recommending that you completely uninstall and remove the older audio device will appear. Click the **Yes** button to continue with the installation of the audio card.
After the installation of the audio card, completely uninstall the existing card and remove the audio card from your computer.

If the system has an onboard audio chipset.

Disable your computer's onboard audio chipset. Consult the documentation of your computer's motherboard for details.

Problems with Sound

No sound from the headphones.

Check the following:

- The headphones are connected to the card's Headphone jack.
- In the Speakers/Headphones tab of the Sound Blaster Z-Series Control Panel, the **Headphones** option is selected.

No audio output when playing digital files such as .WAV, MIDI files or AVI clips.

Check the following:

- The speakers' volume control knob, if any, is set at mid-range. Adjust the volume in Mixer Settings of the Sound Blaster Z-Series Control Panel, if necessary.
- The powered speakers or external amplifier are connected to the card's Line Out jacks.
- There is no hardware conflict between the card and a peripheral device. See Problems with Sound.
- The Speakers/Headphones Configuration settings in the Speakers/Headphones tab of the Sound Blaster Z-Series Control Panel corresponds to your actual speaker or headphone configuration.

Safety Information

Refer to the following information to use your product safely, and to reduce the chance of electric shock, short-circuiting, damage, fire, hearing impairment or other hazards. **Improper handling may void the warranty for your product. For more information, read the warranty available with your product.**

- Do not dismantle or attempt to repair your product.
Refer all servicing to authorized repair agents.
- Do not expose your product to temperatures outside the range of 0°C to 45°C (32°F to 113°F).
- Do not pierce, crush or set fire to your product.
- Keep your product away from strong magnetic objects.
- Do not subject your product to excessive force or impact.
- Do not expose your product to water or moisture.
If your product is moisture-resistant, take care not to immerse your product in water or expose it to rain.

License and Copyright

Information in this document is subject to change without notice and does not represent a commitment on the part of Creative Technology Ltd. No part of this manual may be reproduced or transmitted in any form or by any means, electronic or mechanical, including photocopying and recording, for any purpose without written permission of Creative Technology Ltd.

Copyright © 2012 Creative Technology Ltd. All rights reserved. Creative, the Creative logo, Sound Blaster, the Sound Blaster logo, CrystalVoice, Creative ALchemy, SBX Pro Studio and the SBX logo are trademarks or registered trademarks of Creative Technology Ltd. in the United States and/or other countries. Manufactured under the license from Dolby Laboratories. Dolby and the double-D symbol are trademarks of Dolby Laboratories. All other trademarks are properties of their respective owners. All specifications are subject to change without prior notice. Use of this product is subject to a limited hardware warranty. Actual contents may differ slightly from those pictured. The software included in this package may not be used separately from the hardware. Before using the software, you must agree to be bound by the terms and conditions of the End User License Agreement.

Version 1.0

October 2012