



# Quick Start Guide

DAP-X2850



**D-Link**

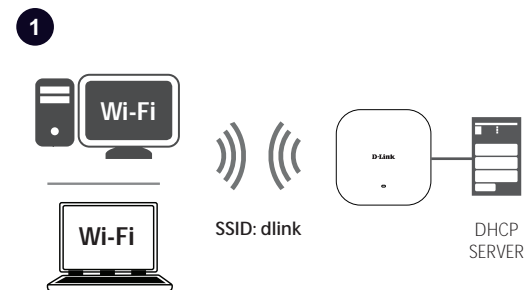
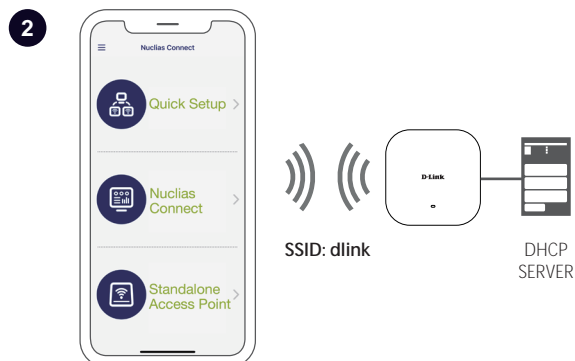
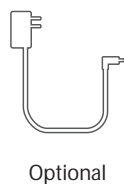
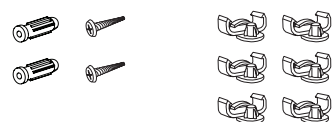

OR

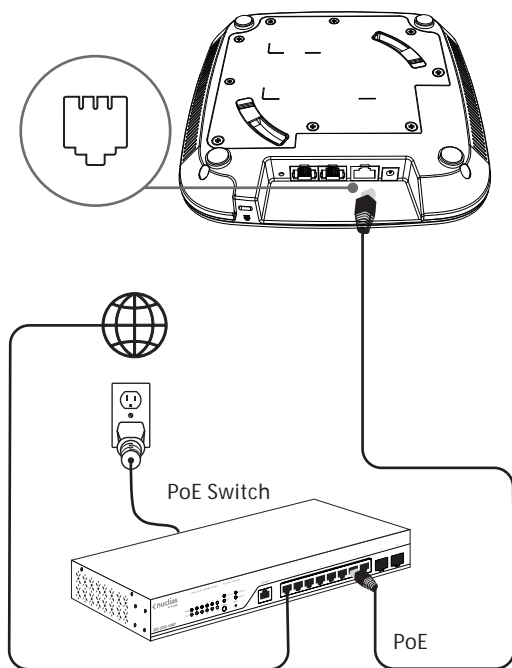
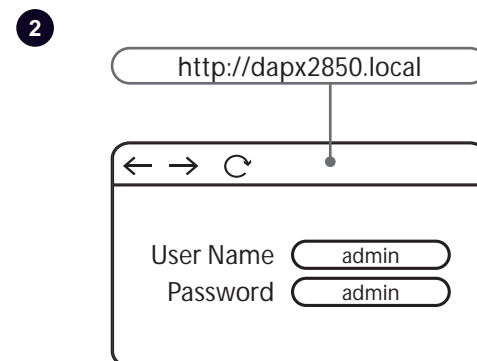

OR

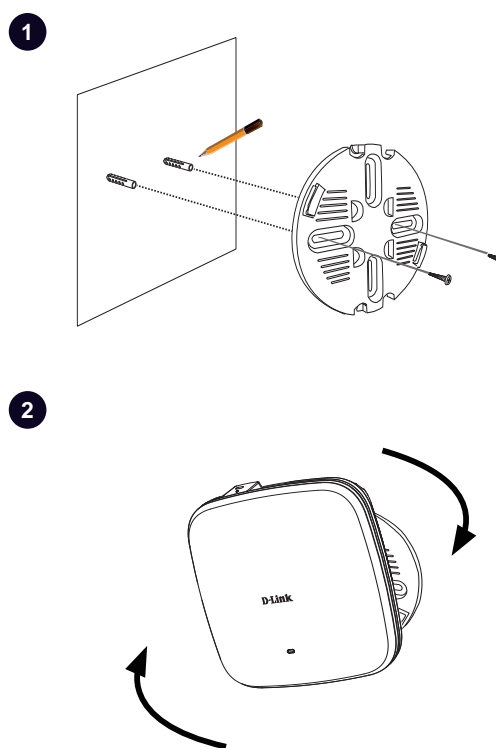
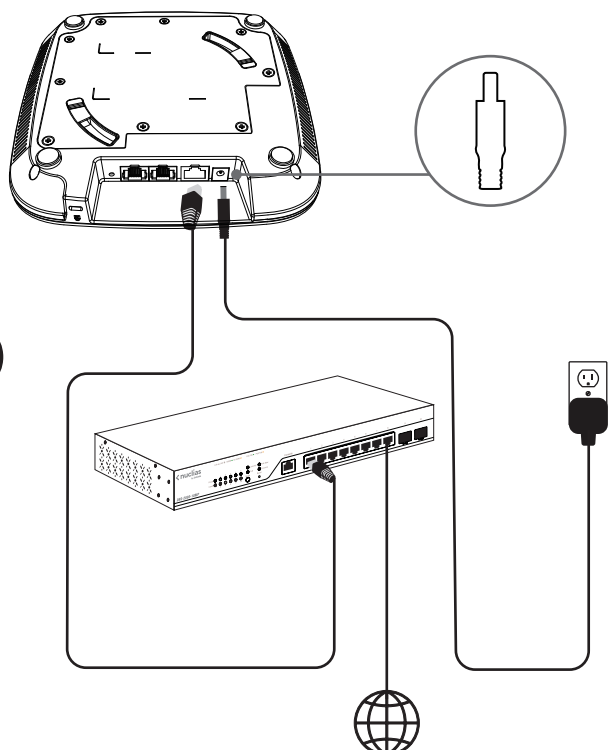

OR

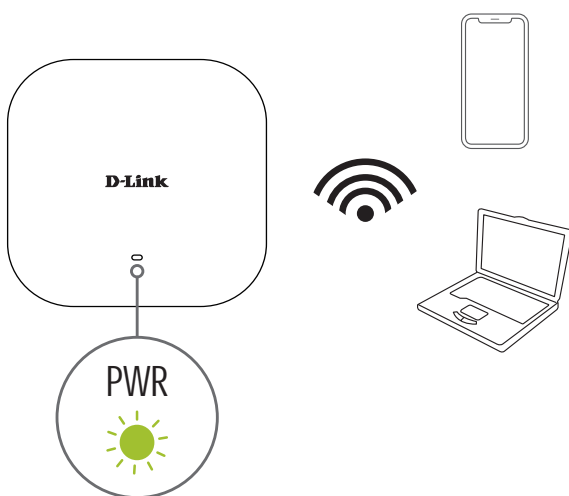
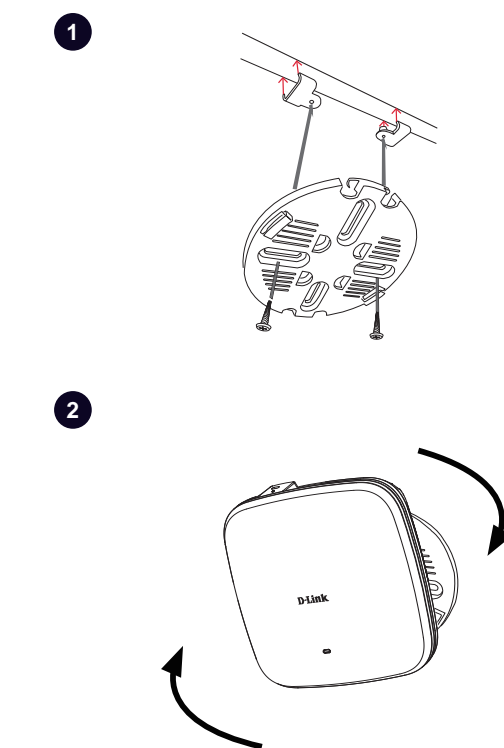

<https://www.nuclias.com>



<https://www.dlink.com/support>



<https://download.nuclias.com>



<https://www.dlink.com/warranty>