

Instruction Manual

Thank you for purchasing this product.
Before using this product please read the instructions carefully.
After reading the instruction manual, please keep it for reference.

Caution



Caution

Parents/Guardians:

Please read the following information carefully.

- This product contains small parts. Keep away from children under 3 years old.
- Keep this product away from small children or infants. Seek medical attention immediately if any small parts are swallowed.
- Long cord. Strangulation hazard.
- Keep the product away from dusty or humid areas.
- Do not use this product if it has been damaged or modified.
- Do not get this product wet. This may cause an electric shock or malfunction.
- Do not place this product near heat sources or leave under direct sunlight for an extended period. Overheating may cause malfunction.
- Do not touch the metal parts of the USB plug.
- Do not apply strong impact or weight on the product.
- Do not pull roughly or bend the cable of the product.
- Do not disassemble, modify or attempt to repair this product.
- If product needs cleaning, use only a soft dry cloth. Do not use any chemical agents like benzene or thinner.
- Do not use this product for anything other than its intended purpose. We are not responsible for any accidents or damages in the event of use other than the intended purpose.

Included

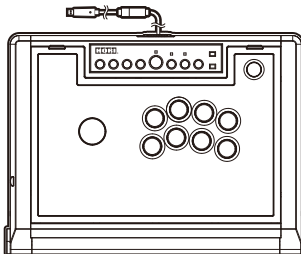

Controller

Platform

Xbox Series X|S / Xbox One / Windows 10

System requirements USB Port, Internet Connection

* Functions as PC controller through XInput.
This product does not support DirectInput.

Important

Before using this product with the Xbox Series X|S / Xbox One system, please read the included instructions carefully.

Please check that your Xbox Series X|S / Xbox One is updated to the latest system firmware.

This product is designed for the Xbox Series X|S, but it can also be used with the Xbox One and Windows 10 by following the instructions in this manual.

Layout

[Front View]

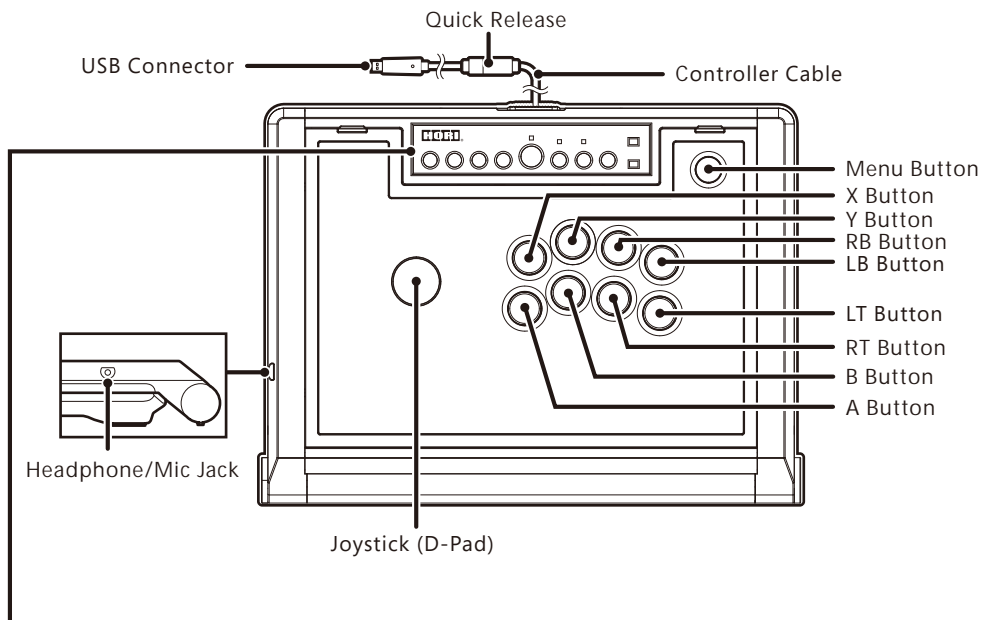

[Subpanel]

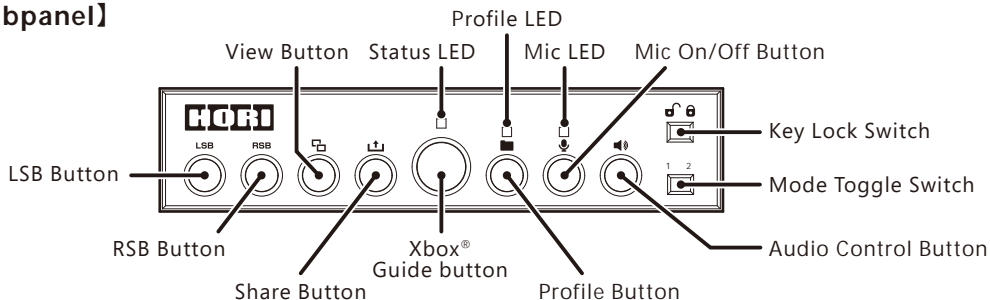

Maintenance and Design Customization

Open the chassis for maintenance or replace the design sheet to customize your Fighting Stick α.

 Please note that damage (such as damaged buttons and quick disconnect blade connectors and covers, broken cables, etc.) caused by user modifications other than replacing buttons or panel art are not covered by warranty.

- Please de-static yourself before touching inside of the product.
- Do not connect the USB plug into the Xbox Series X/ Xbox Series S/ Xbox One console or Windows 10 USB port.
- Do not remove buttons or connectors during gameplay.
- Do not directly touch the metal inside the product with your bare hands.
- Be careful to not get your hands, fingers, hair, or cables caught when opening or closing the chassis.

How to Open the Chassis

① Open the chassis while sliding the sliding lock button.

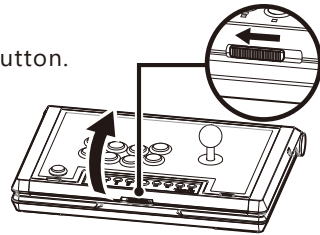

② Open the top case to a vertical position and place the product on a sturdy surface.

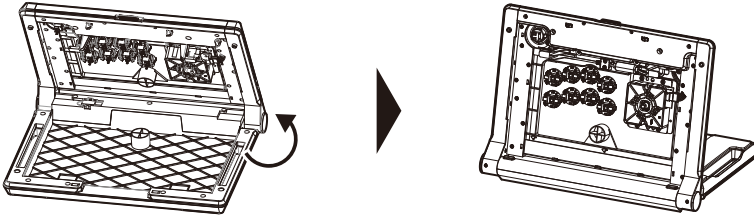

- When performing maintenance, please refer to the “How to Remove a Button” section and the “Cable Wiring Diagram” as shown below.

How to Remove a Button

1) Remove the quick disconnect blade connectors connected to each button.

* When disconnecting the blade connectors, do not pull it out by holding only the wiring cable.

- When installing a button, insert the blade connectors as far as it will go. Refer to the cable wiring diagram below when wiring each button.

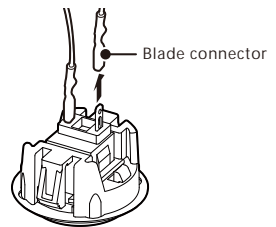

2) As shown in the figure, push the two stoppers little by little to remove them from the housing cover.

* Parts may be damaged if too much force is used.

* Be careful to not cut your hands on the edges of the buttons holes on the housing cover.

- When installing a button, push the button in until the stopper clicks into place.

* After installing, make sure that there is no gap between the button and housing cover.

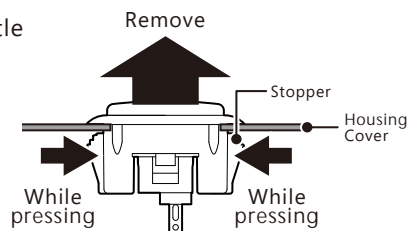

Cable Wiring Diagram

The cable wiring is as shown in the diagram below.

If you do not know the mounting position of the quick disconnect blade connectors after inserting and removing it, refer to the cable wiring diagram below.

* The diagram orientation shown is the inside when the housing cover is opened.

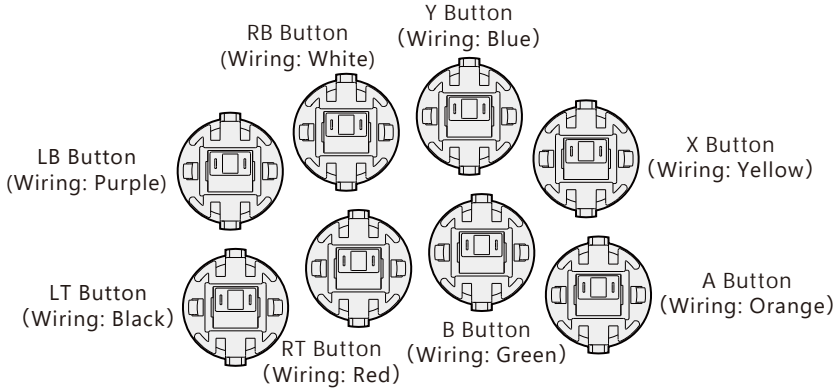

How to Change the Design

- 1) Open the housing cover, place it on a stable surface, and remove the buttons (9) shown in the diagram to the right.

* Please refer to the above information for how to open the housing cover.

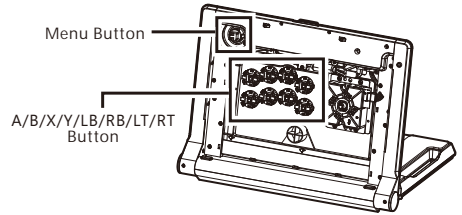

- 2) As shown in the diagram below, remove the screws (8 screws) and joystick ball top.

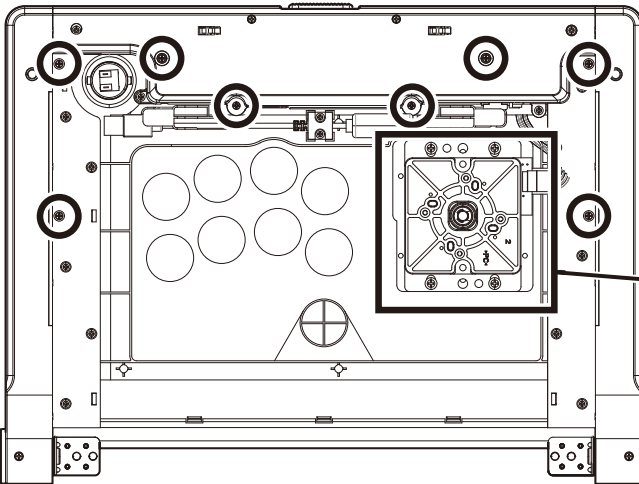

How to remove the joystick ball top

- 1) Hold the round part
 - 2) Turn the screw
- Diagram showing the removal of the joystick ball top using a screwdriver (sold separately) and the Housing Cover.

• The parts are separated as shown in the figure below.

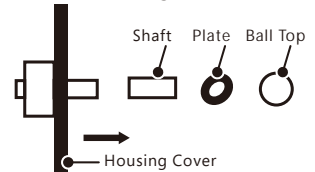

- ③ Open the frame and replace the design sheet.
 * Do not remove the transparent cover. If it comes off, reattach it according to the groove on the frame.

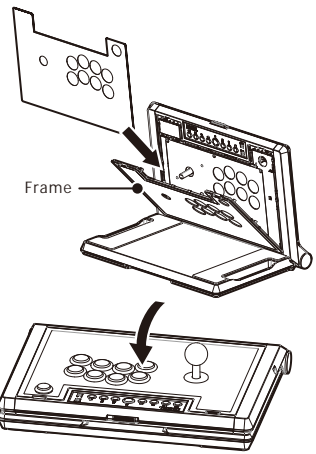

- ④ Close the frame, put the buttons, screws, and joystick back to their original state, and close the housing cover.

How to Connect

- ① Open the housing cover and remove the USB cable.

- 1) Open the housing cover and take out the USB cable.

* For how to open the housing cover, refer to "How to Change the Design" section above.

- 2) Pass the USB cable through the cable hole and close the lid.

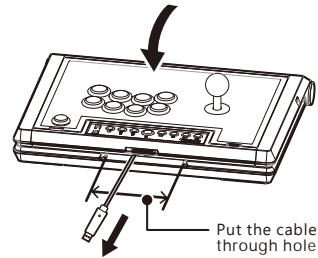
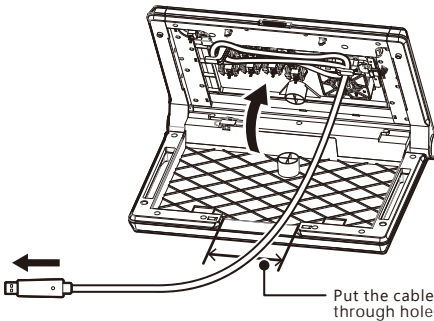

- To put the cable back to its original placement, reverse the previous steps.
- * Be careful not to pinch your hands or USB cable when opening or closing the housing cover.
- * When closing the housing cover, wrap the USB cable around the cable winding part before closing.

- ② Set the Mode Toggle Switch to the appropriate setting then connect the USB cable.

* Do not press on any buttons when connecting the USB cable.
 * Check the connector direction before inserting.

【"MODE-1"】 (For Xbox Series X|S)

* "MODE-1" may not function depending on the software. If that happens, please toggle to "MODE-2".

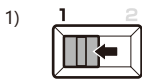

Mode Toggle Switch

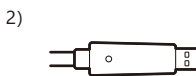

Connect to the USB port of the Xbox Series X|S console.

【"MODE-2"】 (If Mode 1 does not function correctly for Xbox Series X|S or when connecting to a Windows 10 PC)



Mode Toggle Switch

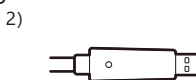

Connect the steering unit USB to the Xbox Series X|S or Windows 10 PC's USB port.

Quick Release

Your controller cord has a quick release. This is a safety feature designed to reduce the chance of the Xbox Series X|S console or computer from falling when the cord is pulled. If the console or computer falls and hits someone, especially a small child, it could cause a serious injury. To reduce the risk of injuries or damage to the console or computer, it is important to use the controller and the quick release properly. Use the controller connector, not the quick release, to routinely connect and disconnect the controller. If the quick release disconnects, simply reconnect it by aligning the grooved indentations and pressing the two parts completely together. The controller will not work unless the quick release is connected properly.





Never tape, glue, or otherwise prevent the quick release from pulling apart. The quick release reduces, but does not eliminate, the risk of the computer or console being pulled off its surface. To further reduce the risk:

- Do not allow anyone to pull on the controller or controller cord in a way that causes the computer or console to move.
- Do not allow controller cords to become crossed or tangled with one another.

Audio Controls

The Volume and Mixer can be adjusted. You will hear a 'beep' when the audio is set to the MAX or MIN volume.

Adjusting Headset Volume



While pressing  +  Increase volume

Audio Control Button Joystick



While pressing  +  Decrease volume

Audio Control Button Joystick

Adjusting Game Audio / Voice Chat Balance

While pressing  +  Increase in-game volume

Audio Control Button Joystick



While pressing  +  Increase voice chat volume

Audio Control Button Joystick



Mic Control

The headset's Mic ON/OFF and Input Sensitivity can be adjusted. You will hear a 'beep' when the mic is set to the MAX or MIN volume.

Mic On/Off



Push   

Mic On/Off Button Mic LED Off Mic Input On



Push   

Mic On/Off Button Mic LED On Mic Input Off

Mic Input Sensitivity Adjustment

While pressing  +  Increase Mic Input Sensitivity

Mic On/Off Button Joystick

While pressing  +  Decrease Mic Input Sensitivity

Mic On/Off Button Joystick

Key Lock Function

Turn Key Lock Mode on by switching the Key Lock switch. Please note that some key inputs are disabled during Key Lock Mode.

In Key Lock Mode, the buttons are disabled as listed in the chart below.



"MODE-1"	"MODE-2"
Xbox® Guide button Menu Button View Button Share Button	Xbox® Guide button Menu Button

Download App

『HORI Device Manager for Xbox Series X』

<How to Download>

- ① Search for "HORI" on the Microsoft Store.
- ② Install the "HORI Device Manager for Xbox Series X" App.

●About Profile

The Profile Button is used to toggle between profiles (profiles are adjusted via the HORI Device Manager for Xbox Series X).



Profiles will switch when the Profile Button is pressed.

The following features can be adjusted in the app:

- D-Pad/ Analog Stick Function
- Assign Mode
- Audio Settings
- Profile

The Profile LED will change based on Profile setting.

Profile Set	Profile LED
1	Green
2	Red
3	Blue
4	White

Main Features

External Dimensions	: 410×300×120mm
Weight	: 2.7kg
Cable Length	: 3.0m
Joystick	: HAYABUSA Button
Button (A/B/X/Y/LB/RB/LT/RT Button)	: HAYABUSA Button
Button (Menu Button)	: HORI Button

THE FCC WANTS YOU TO KNOW

This device complies with part 15 of the FCC Rules. Operation is subject to the following two conditions: (1) This device may not cause harmful interference, and (2) this device must accept any interference received, including interference that may cause undesired operation.

NOTE: This equipment has been tested and found to comply with the limits for a Class B digital device, pursuant to part 15 of the FCC Rules. These limits are designed to provide reasonable protection against harmful interference in a residential installation. This equipment generates, uses and can radiate radio frequency energy and, if not installed and used in accordance with the instructions, may cause harmful interference to radio communications. However, there is no guarantee that interference will not occur in a particular installation. If this equipment does cause harmful interference to radio or television reception, which can be determined by turning the equipment off and on, the user is encouraged to try to correct the interference by one or more of the following measures:

- Reorient or relocate the receiving antenna.
- Increase the separation between the equipment and receiver.
- Connect the equipment into an outlet on a circuit different from that to which the receiver is connected.
- Consult the dealer or an experienced radio/TV technician for help.

The normal function of the product may be disturbed by strong electro-magnetic interference. If so, simply reset the product to resume normal operation by following the instruction manual (How to connect). In case the function does not resume, please relocate to an area which does not have electro-magnetic interference to use the product.

The wires are not to be inserted into socket-outlets.

The packaging must be retained since it contains important information.

PRODUCT DISPOSAL INFORMATION

Where you see this symbol on any of our electrical products or packaging, it indicates that the relevant electrical product or battery should not be disposed of as general household waste in Europe. To ensure the correct waste treatment of the product and battery, please dispose of them in accordance with any applicable local laws or requirements for disposal of electrical equipment or batteries. In so doing, you will help to conserve natural resources and improve standards of environmental protection in treatment and disposal of electrical waste. Applicable to EU countries and Turkey only.



EU and Turkey only

US

Warranty

HORI warrants to the original purchaser that the product purchased new in its original packaging shall be free of any defects in material and workmanship for a period of 90 days from the original date of purchase. If the warranty claim cannot be processed through the original retailer please contact HORI customer support directly at infoeus@hori.jp. Please visit <http://stores.horiusa.com/policies/> for warranty details.

EU

Warranty

For all warranty claims made within the first 30 days after purchase, please check with the retailer where the original purchase was made for details. If the warranty claim cannot be processed through the original retailer or for any other inquiries pertaining to our products, please contact HORI customer support directly at infoeu@hori.jp.

- The image on the package may differ from the actual product.
- The manufacturer reserves the right to change the product design or specifications without notice.
- Microsoft, Xbox, Xbox "Sphere" Design, Xbox Series X|S, Xbox One, Windows are trademarks of the Microsoft group of companies.
- HORI & HORI logo are registered trademarks of HORI.



MADE IN CHINA

Ages 6+