

UM-series

Compact 100V mixer-amplifiers

Item ref: UM30 953.173UK

UM60 953.176UK

UM90 953.179UK

User Manual

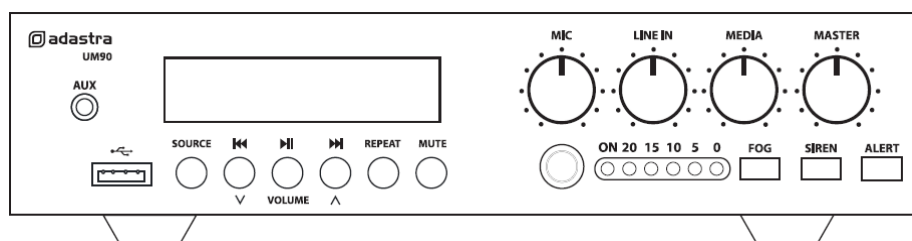
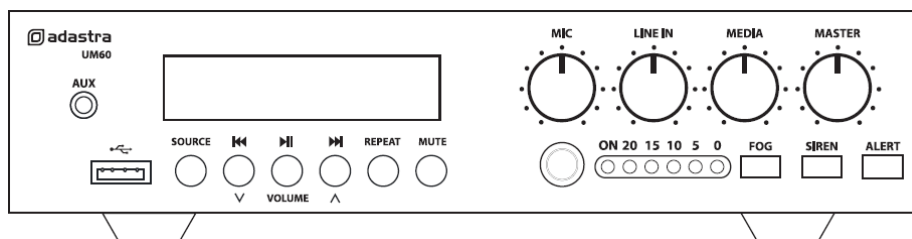
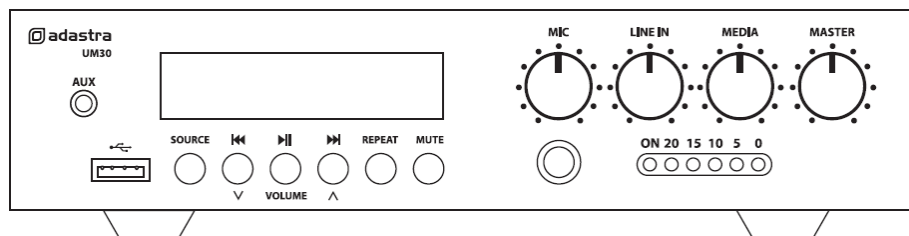

Version 2.0



Caution: Please read this manual carefully before operating
Damage caused by misuse is not covered by the warranty

Introduction

Thank you for choosing an Adastra UM-series mixer-amplifier as part of your public address system. This unit is designed to offer high quality, dependable service for mobile and installed systems. Please read this manual to gain the best results from your product and avoid damage through misuse.

SAFETY SYMBOL AND MESSAGE CONVENTIONS



CAUTION
RISK OF ELECTRIC SHOCK
DO NOT OPEN

AVIS
RISQUE DE CHOC ELECTRIQUE NE PAS
OUVRIR



This symbol indicates that dangerous voltage constituting a risk of electric shock is present within this unit



This symbol indicates that there are important operating and maintenance instructions in the literature accompanying this unit.



SAFETY NOTICE

1. Prior to use, read through this manual
2. Keep the manual in good condition
3. Pay attention to safety warnings
4. Observe all operating requirements
5. Do not use the device near water or wet areas
6. For cleaning, only use a lint-free, dry cloth
7. Install according to the specifications
8. Place away from heat sources or heating appliances
9. Use mains lead provided and avoid damage to cable or connectors
10. Unplug power from mains during stormy weather or if unused for long periods
11. In case of malfunction, water ingress or other damage, consult qualified service personnel
12. Do not place in damp areas or near liquids or moisture. Do not spill liquids on the housing
13. Please pay attention to warning symbols during transit and placement
14. Terminals marked with the ⚡ symbol are HAZARDOUS LIVE and should only be connected by qualified personnel
15. Ensure that the apparatus is connected to a mains socket with a protective EARTH connection
16. Ensure correct operation of the mains switch

Warning

To prevent the risk of fire or electric shock, do not expose any components to rain or moisture.

If liquids are spilled on the casing, stop using immediately, allow unit to dry out and have checked by qualified personnel before further use. Avoid impact, extreme pressure or heavy vibration to the case

No user serviceable parts inside – Do not open the case – refer all servicing to qualified service personnel.

Safety

- Check for correct mains voltage and condition of IEC lead before connecting to power outlet
- Use double insulated speaker wire with adequate current rating for 100V speaker connections
- Only use 1 type of output – i.e. **8Ω or 100V** – do not mix or combine these outputs on a single zone
- Do not connect **8Ω speakers to the 100V terminal or 100V speakers to the 8Ω terminal**
- Do not allow any foreign objects to enter the case or through the ventilation grilles

Placement

- Keep out of direct sunlight and away from heat sources
- Keep away from damp or dusty environments
- For rack-mounting, use the supplied accessories and ensure adequate support
- Ensure adequate airflow and do not cover cooling vents at the front and rear of the amplifier
- Ensure adequate access to controls and connections

Cleaning

- Use a soft cloth with a neutral detergent to clean the casing as required
- Use a vacuum cleaner to clear ventilation grilles of any dust or debris build-ups
- Do not use strong solvents for cleaning the unit

Rack mounting

The UM series amplifiers can be mounted into a 19" rack cabinet using the supplied rack accessories. As shown below, the 2 joining brackets link a pair of UM series amplifiers together to form a full-width 1U rack-mount pair. One rack ear can be mounted at each end for fixing to the rack strip.

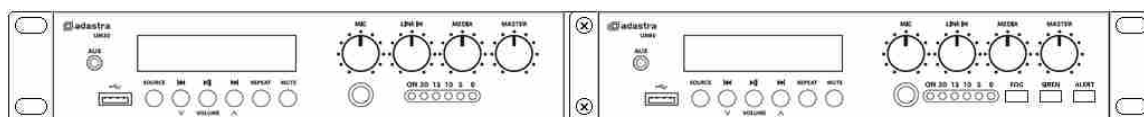

Wall or under counter mounting

The rack mounting accessories can also be attached so that the amplifier can be mounted against a wall or under a counter or work surface. To do this, mount the rack ears with the tabs aligned with the top of the housing to provide mounting holes to screw the amplifier to the underside of a work surface or against a wall with the controls visible vertically.

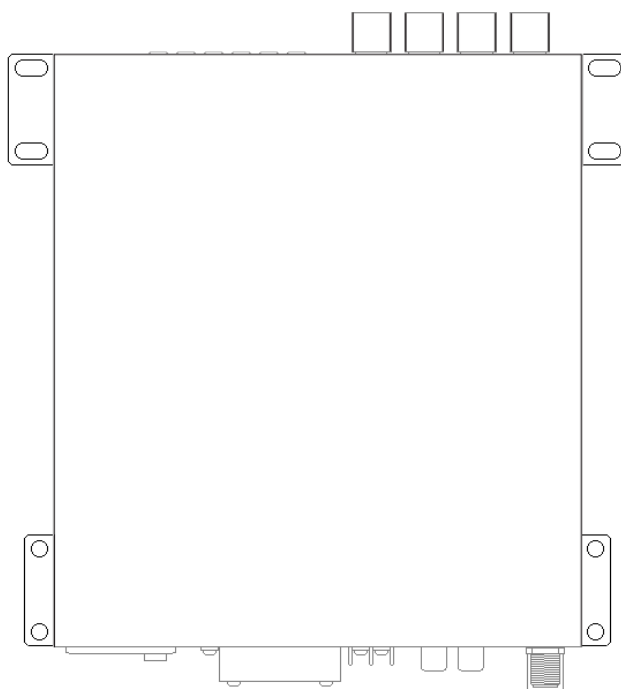

Front panel

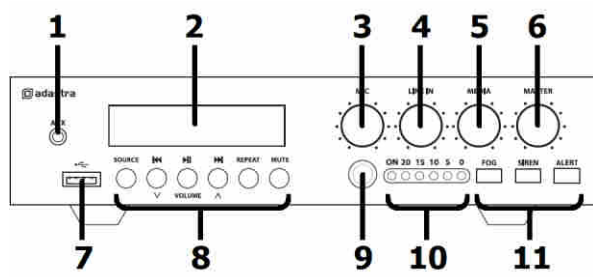

- | | |
|---|--|
| <ol style="list-style-type: none"> 1. 3.5mm stereo AUX input 2. Media player display 3. MIC volume control 4. LINE IN volume control 5. MEDIA volume control 6. MASTER volume control | <ol style="list-style-type: none"> 7. USB port 8. Media player controls 9. Microphone input jack 10. VU meter 11. FOG / SIREN / ALERT buttons (UM60 only) |
|---|--|

Rear panel

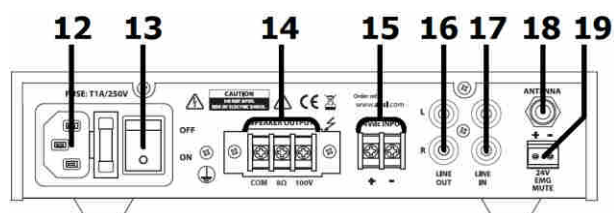

12. IEC power inlet and fuse holder
13. Power on/off switch
14. Speaker output terminals
15. DC power terminals
16. LINE OUT connectors (RCA)
17. LINE IN connectors (RCA)
18. Antenna F connector
19. 24V MUTE terminals

Connection and setup

Connect the rear IEC inlet (12) to the mains using the supplied mains lead (or an equivalent approved type). Alternatively, the amplifier can be powered by a 12V battery, such as a car or boat battery, by connecting the **"+" and "-"** of the battery to the 12Vdc INPUT (15) on the rear panel. Ensure that DC cables are capable of handling the current (6A min. recommended)

Connect a microphone (if required) to the front panel jack input (9).

Connect any line level audio inputs to the LINE IN connectors (17) on the rear panel using good quality RCA leads. An additional 3.5mm AUX line input (1) is provided on the front panel for connecting a playback device such as a smart phone or MP3 player.

Further amplifiers can be connected from the rear LINE OUT sockets (16)

For stable **FM radio reception**, connect the **Antenna 'F' type socket (18)** to a suitable FM antenna.

The UM series amplifiers can be used either as 100V line amplifiers or standard low impedance power amplifiers. These 2 configurations cannot be used together, so it is important to decide which method will be used at the start.

100V line systems

For 100V line systems, connect the amplifier to the first speaker in the system using double-insulated speaker wire which has adequate current rating to handle the total output of the amplifier.

Connect **the "100V"** output terminal to the positive (+) **connection of the speaker and "COM"** output to the negative (-) connection of the speaker (14). Connect further speakers in parallel to the first speaker with all positive terminals connected together and all negative terminals connected together as shown below.

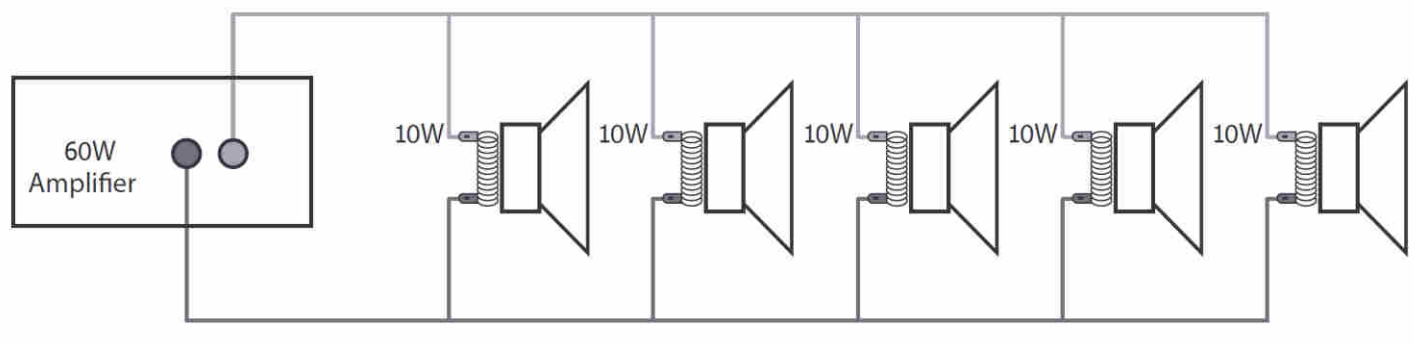

A 100V line speaker system can comprise of many speakers connected together. The determining factor for how many speakers can be used on a single amplifier is the power rating. For most purposes, it is advised to **connect as many speakers as needed with a combined wattage of no more than 90% of the amplifier's output power rating.**

The terminals of a 100V speaker are connected to a transformer and in some cases, this transformer may be **"tapped"** for different power ratings. **These tapings can be used to** adjust the wattage (and output volume) of each speaker in the system to help achieve the ideal total power of the system for the amplifier.

Low impedance systems

The UM30/60 amplifiers can alternatively provide an output for a single **8Ω speaker by connecting the "8Ω"** output **to the positive (+) speaker connection and "COM" output** to the negative (-) speaker connection. It is important to ensure that the speaker load is no lower than **8Ω and that the power handling of the speaker** is equal to or greater than the output power of the amplifier.

Operation

When all connections to the amplifier are made, turn all rotary controls down and switch on the power (13) and a power LED will illuminate. Ensure a signal is being fed to the LINE IN connection and gradually increase the MASTER rotary control (6) part way for testing. Increase the LINE IN rotary (4) until the output is heard through the speakers. Turn up the MASTER to the maximum required volume level and reduce the LINE IN control if necessary.

Note: If a line input is not connected to a UM series mixer-amplifier, the initial test can be made using the built-in Media audio player. See section below for instructions.

If a microphone is connected, make sure it is switched on and gradually increase the MIC control (3) whilst speaking into the microphone until the required volume level is reached. The microphone should not be able to **“hear” the speakers, which can cause feedback** (squealing or howling noise).

Media player

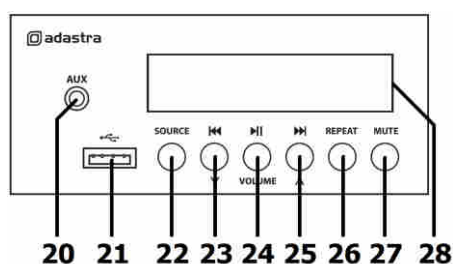

20. AUX input 3.5mm jack
21. USB port
22. SOURCE select button
23. Previous / volume down button
24. Play / pause button
25. Next / volume up button
26. REPEAT mode button
27. MUTE button
28. Media player display

UM series mixer-amplifiers are fitted with a built-in media player. This section comprises a Bluetooth receiver, USB audio player, FM tuner and AUX input. Pressing the SOURCE select button (22) will step through Bluetooth, USB, AUX and FM tuner modes. Pressing the MUTE button (27) for any source will mute the output.

Bluetooth

The Bluetooth function allows connection of a smart phone or tablet to the media player section for playback of stored files or streamed digital audio.

In order to enable this function, it will be necessary to pair the sending device to the receiver as follows.

1. Open the Bluetooth settings menu on the smart phone or tablet (or other sending device)
2. **Scan for Bluetooth devices and look for “adastra 0000” in the list of available devices**
(ensure that the UM amp is powered on and within reception range)
3. **Select “adastra 0000” and the sending device should confirm that it is connected as an audio device.**
(note that “0000” may be a different number if it has been edited – see below)
4. Play audio from the sending device, ensuring that volume controls are not turned down/muted
5. Turn up the MEDIA volume control (5) on the amplifier to the required level.

The Previous, Next and Play/pause buttons (23, 25, 24) will operate in Bluetooth as remote playback controls. Holding the Previous track or Next track buttons will adjust the output volume of the player down or up.

The Bluetooth name can be customized to enable identification of individual nearby amplifiers.

To customize the Bluetooth number press and hold the Play/Pause button until adastra 0000 is displayed with one of the characters flashing. Press Previous or Next buttons to edit the number and Play/Pause to select another character. Hold Play/Pause to store the ID and exit.

Note: Android devices have the facility to re-name devices within the Bluetooth settings menu.

If the Bluetooth ID has been re-named on the Android device, editing the Bluetooth ID on the media player will not affect the name displayed on that Android device.

FM Tuner

The FM tuner function operates in the same way as a standard FM radio and benefits from the connection of **an FM antenna to the rear panel 'F' type connector**.

If no channels are tuned in, press the Play/Pause button (24) to begin auto tuning, which scans available stations and stores them as channels within the FM tuner. Pressing Play/Pause again will abort auto-tuning.

To delete any selected station, press and hold the Repeat button (26).
Repeat the auto tuning process to re-populate any missing presets.

To step through pre-set stations, press the Previous or Next buttons (23, 25).
Turn up the MEDIA control (5) to hear the output from the speakers and increase to the required level.

Holding the Previous track or Next track buttons will adjust the output volume of the player.

USB player

When a USB memory stick is inserted into the USB port (21), the track number and time will show in the display and audio files will start to play automatically.

If playback does not start automatically, press the SOURCE select button (22) and Play/Pause button (24) to check if the player is set to the correct mode. Try Previous track and Next track buttons (23, 25) if the selected track is unable to play. Also, check that the audio files are mp3 type.

Turn up the MEDIA control (5) to hear the output from the speakers and increase to the required level.

There are 3 Repeat modes: Repeat All tracks, Repeat Current track and Random.
Pressing the REPEAT button (26) will cycle through these modes as shown in the top right of the display.

Pressing the Previous track button (23) briefly steps backwards through tracks on the memory device. Press and hold this button to decrease the playback volume.

Pressing the Next track button (25) briefly steps forwards through tracks on the memory device.
Press and hold this button to increase the playback volume.

To pause the current track, press the Play/Pause button (24) and press it again to resume playback.

AUX input

When a playback device is connected to the 3.5mm AUX input, the display **will show "AUX"**.
Alternatively, this source can be selected by the SOURCE button.

The output level of this AUX input is controlled by the MEDIA volume control and is independent of the rear RCA line inputs. When other media player sources are selected, this AUX input is muted.

Fog/Siren/Alert buttons

In addition to audio controls, the UM60 front panel has 3 warning sound buttons. Pressing any of these will issue one of 3 preset warning sounds through the speakers for alerts and/or emergency announcements.

To avoid loud pops through the speakers, turn down the MASTER control before powering down.

Specifications

Model	UM30	UM60	UM90
Output power: RMS	30W	60W	90W
Alarm output	N/A	Fog/Siren/Alert generator	Fog/Siren/Alert generator
Dimensions	249 x 210 x 44mm	269 x 210 x 44mm	300 x 210 x 44mm
Weight	2.35kg	2.47kg	2.99kg
Power supply	170-264Vac, 50Hz (IEC)		
Amplifier: construction	Class D + transformer output		
Audio source	Internal USB/FM/BT player		
Inputs	1 x mic (6.3mm), 1 x line (2 x RCA), 1 x aux (3.5mm)		
Line output	2 x RCA (mono)		
Speaker outputs	Screw terminals - 100V / 8 Ohms / Com		
DC power	24Vdc screw terminals		
Mute	24V relay contacts		
THD	<0.4% @ 1kHz		
Input impedance	1k Ohms (mic/line)		
Input sensitivity	-10dB (line), -45dB (mic)		
SNR	80dB (line), 75dB (mic)		
Frequency response	100Hz - 18kHz		

Troubleshooting

No power LED on control panel	Ensure IEC lead, mains switch and inlet fuse If 12Vdc power input is being used, check battery is charged
Power LED is on but no other LEDs and no output	Check input signals and condition of input connection leads Check MASTER, MIC, LINE IN or MEDIA controls are turned up
Power light and output LEDs lighting but no output	Check speaker output terminals are connected correctly Check speakers are working (test on another amp if available)
Bluetooth cannot connect	Ensure that the sending device is within Bluetooth range (5-10m) Check that the connected device is the correct ID
No audio from connected Bluetooth device	Ensure that volume controls are not turned down on sending device Check volume and Play/Pause buttons in case Bluetooth is muted
USB player will not play audio from media	Press PLAY on transport controls Check memory device is connected properly (remove and re-insert) Check file types – standard compressed digital audio files required Check memory device works on a PC or Mac for standard playback
Output is very loud or distorted	Check level of input signal is not too high Reduce MIC, LINE IN, MEDIA and/or MASTER level Ensure Hi-Z line level input(s) not connected via MIC input
Output is working but at very low level	Check input audio source level is not too low Increase MIC, LINE IN, MEDIA and/or MASTER level Check for quiet recording of media files on USB
Feedback from microphone	Face microphone away from speakers and monitors Turn down MIC and/or MASTER level
Amplifier overheating or cutting out	Check that 8Ω speakers are not connected to 100V terminals Ensure total 100V speaker wattage is lower than amplifier rating Ensure that 100V and 8Ω speakers are not both connected



Disposal: The "Crossed Wheelie Bin" symbol on the product means that the product is classed as Electrical or Electronic equipment and should not be disposed with other household or commercial waste at the end of its useful life. The goods must be disposed of according to your local council guidelines.

*Errors and omissions excepted. Copyright © 2020. AVSL Group Ltd.
Unit 2-4 Bridgewater Park, Taylor Rd. Manchester. M41 7JQ*