

**TUF GAMING
B550-PLUS (Wi-Fi)**

ASUS
Motherboard

E16879
First Edition
July 2020

Copyright © 2020 ASUSTeK COMPUTER INC. All Rights Reserved.

No part of this manual, including the products and software described in it, may be reproduced, transmitted, transcribed, stored in a retrieval system, or translated into any language in any form or by any means, except documentation kept by the purchaser for backup purposes, without the express written permission of ASUSTeK COMPUTER INC. ("ASUS").

Product warranty or service will not be extended if: (1) the product is repaired, modified or altered, unless such repair, modification of alteration is authorized in writing by ASUS; or (2) the serial number of the product is defaced or missing.

ASUS PROVIDES THIS MANUAL "AS IS" WITHOUT WARRANTY OF ANY KIND, EITHER EXPRESS OR IMPLIED, INCLUDING BUT NOT LIMITED TO THE IMPLIED WARRANTIES OR CONDITIONS OF MERCHANTABILITY OR FITNESS FOR A PARTICULAR PURPOSE. IN NO EVENT SHALL ASUS, ITS DIRECTORS, OFFICERS, EMPLOYEES OR AGENTS BE LIABLE FOR ANY INDIRECT, SPECIAL, INCIDENTAL, OR CONSEQUENTIAL DAMAGES (INCLUDING DAMAGES FOR LOSS OF PROFITS, LOSS OF BUSINESS, LOSS OF USE OR DATA, INTERRUPTION OF BUSINESS AND THE LIKE), EVEN IF ASUS HAS BEEN ADVISED OF THE POSSIBILITY OF SUCH DAMAGES ARISING FROM ANY DEFECT OR ERROR IN THIS MANUAL OR PRODUCT.

SPECIFICATIONS AND INFORMATION CONTAINED IN THIS MANUAL ARE FURNISHED FOR INFORMATIONAL USE ONLY, AND ARE SUBJECT TO CHANGE AT ANY TIME WITHOUT NOTICE, AND SHOULD NOT BE CONSTRUED AS A COMMITMENT BY ASUS. ASUS ASSUMES NO RESPONSIBILITY OR LIABILITY FOR ANY ERRORS OR INACCURACIES THAT MAY APPEAR IN THIS MANUAL, INCLUDING THE PRODUCTS AND SOFTWARE DESCRIBED IN IT.

Products and corporate names appearing in this manual may or may not be registered trademarks or copyrights of their respective companies, and are used only for identification or explanation and to the owners' benefit, without intent to infringe.

Offer to Provide Source Code of Certain Software

This product contains copyrighted software that is licensed under the General Public License ("GPL"), under the Lesser General Public License Version ("LGPL") and/or other Free Open Source Software Licenses. Such software in this product is distributed without any warranty to the extent permitted by the applicable law. Copies of these licenses are included in this product.

Where the applicable license entitles you to the source code of such software and/or other additional data, you may obtain it for a period of three years after our last shipment of the product, either

(1) for free by downloading it from <https://www.asus.com/support/>

or

(2) for the cost of reproduction and shipment, which is dependent on the preferred carrier and the location where you want to have it shipped to, by sending a request to:

ASUSTeK Computer Inc.
Legal Compliance Dept.
1F., No.15, Lide Rd.,
Beitou Dist., Taipei City 112
Taiwan

In your request please provide the name, model number and version, as stated in the About Box of the product for which you wish to obtain the corresponding source code and your contact details so that we can coordinate the terms and cost of shipment with you.

The source code will be distributed WITHOUT ANY WARRANTY and licensed under the same license as the corresponding binary/object code.

This offer is valid to anyone in receipt of this information.

ASUSTeK is eager to duly provide complete source code as required under various Free Open Source Software licenses. If however you encounter any problems in obtaining the full corresponding source code we would be much obliged if you give us a notification to the email address gpl@asus.com, stating the product and describing the problem (please DO NOT send large attachments such as source code archives, etc. to this email address).

Contents

Safety information.....	iv
About this guide.....	v
Package contents.....	vi
TUF GAMING B550-PLUS (Wi-Fi) specifications summary.....	vi
Connectors with shared bandwidth	x
Chapter 1	Product Introduction
1.1 Before you proceed.....	1-1
1.2 Motherboard overview	1-1
1.3 Central Processing Unit (CPU).....	1-9
1.4 System memory.....	1-10
1.5 M.2 installation.....	1-11
Chapter 2	BIOS and RAID Support
2.1 Knowing BIOS.....	2-1
2.2 BIOS Setup program	2-2
2.3 ASUS EZ Flash 3.....	2-3
2.4 ASUS CrashFree BIOS 3.....	2-4
2.5 RAID configurations.....	2-5
Appendix	
ASUS contact information.....	A-8

Safety information

Electrical safety

- To prevent electrical shock hazard, disconnect the power cable from the electrical outlet before relocating the system.
- When adding or removing devices to or from the system, ensure that the power cables for the devices are unplugged before the signal cables are connected. If possible, disconnect all power cables from the existing system before you add a device.
- Before connecting or removing signal cables from the motherboard, ensure that all power cables are unplugged.
- Seek professional assistance before using an adapter or extension cord. These devices could interrupt the grounding circuit.
- Ensure that your power supply is set to the correct voltage in your area. If you are not sure about the voltage of the electrical outlet you are using, contact your local power company.
- If the power supply is broken, do not try to fix it by yourself. Contact a qualified service technician or your retailer.

Operation safety

- Before installing the motherboard and adding components, carefully read all the manuals that came with the package.
- Before using the product, ensure all cables are correctly connected and the power cables are not damaged. If you detect any damage, contact your dealer immediately.
- To avoid short circuits, keep paper clips, screws, and staples away from connectors, slots, sockets and circuitry.
- Avoid dust, humidity, and temperature extremes. Do not place the product in any area where it may be exposed to moisture.
- Place the product on a stable surface.
- If you encounter technical problems with the product, contact a qualified service technician or your retailer.
- Your motherboard should only be used in environments with ambient temperatures between 0°C and 40°C.

About this guide

This user guide contains the information you need when installing and configuring the motherboard.

How this guide is organized

This guide contains the following parts:

- **Chapter 1: Product Introduction**

This chapter describes the features of the motherboard and the new technology it supports. It includes descriptions of the switches, jumpers, and connectors on the motherboard.

- **Chapter 2: BIOS and RAID Support**

This chapter tells how to boot into the BIOS, upgrade BIOS using the EZ Flash Utility and support on RAID.

Where to find more information

Refer to the following sources for additional information and for product and software updates.

1. **ASUS website**

The ASUS website provides updated information on ASUS hardware and software products. Refer to the ASUS contact information.

2. **Optional documentation**

Your product package may include optional documentation, such as warranty flyers, that may have been added by your dealer. These documents are not part of the standard package.

Conventions used in this guide

To ensure that you perform certain tasks properly, take note of the following symbols used throughout this manual.



CAUTION: Information to prevent damage to the components and injuries to yourself when trying to complete a task.



IMPORTANT: Instructions that you **MUST** follow to complete a task.



NOTE: Tips and additional information to help you complete a task.

Package contents

Check your motherboard package for the following items.

Motherboard	1 x TUF GAMING B550-PLUS (Wi-Fi) motherboard
Cables	2 x SATA 6Gb/s cables
Miscellaneous	1 x I/O Shield 1 x M.2 Rubber package 1 x M.2 SSD screw package 1 x TUF Gaming sticker
Application DVD	1 x Support DVD
Documentation	1 x TUF Certification card 1 x User manual



If any of the above items is damaged or missing, contact your retailer.

TUF GAMING B550-PLUS (Wi-Fi) specifications summary

CPU	AMD Socket AM4 for 3 rd Gen AMD Ryzen™ and 3 rd Gen AMD Ryzen™ with Radeon™ Graphics Processors* *Refer to www.asus.com for CPU support list.
Chipset	AMD B550 Chipset
Memory	3rd Gen AMD Ryzen™ Processors 4 x DIMM, Max. 128GB, DDR4 4600(O.C.)/4400(O.C.)/4266(O.C.)/4133(O.C.)/4000(O.C.)/3866(O.C.)/3733(O.C.)/3600(O.C.)/3466(O.C.)/3333(O.C.)/3200/3000/2800/2666/2400/2133 MHz, Un-buffered Memory* 3rd Gen AMD Ryzen™ with Radeon™ Graphics Processors 4 x DIMM, Max. 128GB, DDR4 4800(O.C.)/4600(O.C.)/4466(O.C.)/4400(O.C.)/4266(O.C.)/4133(O.C.)/4000(O.C.)/3866(O.C.)/3733(O.C.)/3600(O.C.)/3466(O.C.)/3333(O.C.)/3200/3000/2800/2666/2400/2133 MHz, Un-buffered Memory* Dual Channel Memory Architecture *ECC Memory (ECC mode) support varies by CPU. **Refer to www.asus.com for the Memory QVL (Qualified Vendors Lists).
Graphics	1 x DisplayPort 1.2 1 x HDMI™ 2.1 (4K@60HZ) *Graphics specifications may vary between CPU types.
Expansion Slots	3rd Gen AMD Ryzen™ Processors 1 x PCIe 4.0 x16 slot (supports x16 mode) 3rd Gen AMD Ryzen™ with Radeon™ Graphics Processors 1 x PCIe 3.0 x16 slot (supports x16 mode) AMD B550 Chipset 1 x PCIe 3.0 x16 slot (supports x4 mode)* 3 x PCIe 3.0 x1 slots* *PCIe 3.0 X16_2 runs x1 mode when any of the PCIe 3.0 x1 slots is occupied. **Support PCIe bifurcation for RAID on CPU function.
Multi-GPU Support	Supports AMD 2-Way CrossFireX™ Technology

(continued on the next page)

TUF GAMING B550-PLUS (Wi-Fi) specifications summary

Storage	<p>Total supports 2 x M.2 slots and 6 x SATA 6Gb/s ports</p> <p>3rd Gen AMD Ryzen™ Processors M.2_1 slot (Key M), type 2242/2260/2280/22110 (supports PCIe 4.0 x4 & SATA modes)</p> <p>3rd Gen AMD Ryzen™ with Radeon™ Graphics Processors M.2_1 slot (Key M), type 2242/2260/2280/22110 (supports PCIe 3.0 x4 & SATA modes)</p> <p>AMD B550 Chipset M.2_2 slot (Key M), type 2242/2260/2280/22110 (supports PCIe 3.0 x4 & SATA modes)*</p> <p>6 x SATA 6Gb/s ports</p> <p>Supports RAID 0, 1, 10</p> <p>* M.2_2 shares bandwidth with SATA6G_56. When M.2_2 is populated, SATA6G_56 will be disabled.</p>
Ethernet	1 x Realtek RTL8125B 2.5Gb Ethernet
Wireless & Bluetooth	<p>Intel® Wi-Fi 6 AX200</p> <p>2x2 Wi-Fi 6 (802.11 a/b/g/n/ac/ax) support 1024QAM/OFDMA/MU-MIMO</p> <p>Supports up to 2.4Gbps max data rate</p> <p>Supports 2.4/5GHz Dual-Band</p> <p>Supports channel bandwidth: HT20/HT40/HT80/HT160</p> <p>Supports PCIe interface</p> <p>Bluetooth v5.1*</p> <p>*Bluetooth 5.1 function will be ready in Windows 10 build 19041 or later.</p>
USB	<p>Rear USB (Total 8 ports)</p> <p>2 x USB 3.2 Gen 2 ports (1 x Type-A + 1 x USB Type-C®)</p> <p>4 x USB 3.2 Gen 1 ports (4 x Type-A)</p> <p>2 x USB 2.0 ports (2 x Type-A)</p> <p>Front USB (Total 6 ports)</p> <p>1 x USB 3.2 Gen 1 header supports additional 2 USB 3.2 Gen 1 ports</p> <p>2 x USB 2.0 headers support additional 4 USB 2.0 ports</p>
Audio	<p>Realtek ALC S1200A 7.1 Surround Sound High Definition Audio CODEC*</p> <ul style="list-style-type: none"> - Supports Jack detection, Multi-streaming, Front Panel Jack-retasking - Supports up to 24-Bit/192 kHz playback <p>Audio Features</p> <ul style="list-style-type: none"> - Audio Shielding - Rear optical S/PDIF out port - Premium Japanese audio capacitors - Dedicated audio PCB layers - Audio cover - Unique de-pop circuit

(continued on the next page)

TUF GAMING B550-PLUS (Wi-Fi) specifications summary

Back Panel I/O Ports	2 x USB 3.2 Gen 2 ports (1 x Type-A + 1 x USB Type-C®) 4 x USB 3.2 Gen 1 ports (4 x Type-A) 2 x USB 2.0 ports (2 x Type-A) 1 x DisplayPort 1 x HDMI™ port 1 x ASUS Wi-Fi Module 1 x Realtek RTL8125B 2.5Gb Ethernet port 5 x Audio jacks 1 x Optical S/PDIF out port 1 x BIOS FlashBack™ button
Internal I/O Connectors	Fan and cooling related 1 x 4-pin CPU Fan header 1 x 4-pin CPU OPT Fan header 1 x 4-pin AIO Pump header 3 x 4-pin Chassis Fan headers Power related 1 x 24-pin Main Power connector 1 x 8-pin +12V Power connector Storage related 2 x M.2 slots (Key M) 6 x SATA 6Gb/s ports USB 1 x USB 3.2 Gen 1 header supports additional 2 USB 3.2 Gen 1 ports 2 x USB 2.0 headers support additional 4 USB 2.0 ports Miscellaneous 2 x AURA Addressable Gen 2 headers 2 x AURA RGB headers 1 x Clear CMOS header 1 x COM Port header 1 x Front Panel Audio header (AAFP) 1 x SPI TPM header (14-1pin) 1 x 20-5 pin System Panel header 1 x Thermal Sensor header 1 x Thunderbolt header
Special Features	ASUS TUF PROTECTION <ul style="list-style-type: none"> - ASUS DIGI+ VRM (Digital power design with DrMOS) - ASUS Enhanced DRAM Overcurrent Protection - ASUS ESD Guards - TUF LANGuard - ASUS Overvoltage Protection - ASUS SafeSlot - ASUS Stainless-Steel Back I/O

(continued on the next page)

TUF GAMING B550-PLUS (Wi-Fi) specifications summary

<p>Special Features</p>	<p>ASUS Q-Design</p> <ul style="list-style-type: none"> - ASUS Q-DIMM - ASUS Q-LED (CPU [red], DRAM [yellow], VGA [white], Boot Device [yellow green]) - ASUS Q-Slot <p>ASUS Thermal Solution</p> <ul style="list-style-type: none"> - Aluminum M.2 heatsink <p>ASUS EZ DIY</p> <ul style="list-style-type: none"> - BIOS FlashBack™ button - BIOS FlashBack™ LED - Procool <p>AURA Sync</p> <ul style="list-style-type: none"> - AURA RGB headers - Addressable Gen 2 RGB header
<p>Software Features</p>	<p>ASUS Exclusive Software</p> <p>Armoury Crate</p> <ul style="list-style-type: none"> - Aura Sync - AI Noise-Canceling Microphone <p>AI Suite 3</p> <ul style="list-style-type: none"> - Performance and Power Saving Utility <p>TurboV EVO</p> <p>EPU</p> <p>Digi+ VRM</p> <p>Fan Xpert 4</p> <p>PC Cleaner</p> <ul style="list-style-type: none"> - EZ update - System Information <p>Aura Creator</p> <p>TUF GAMING CPU-Z</p> <p>AI Charger</p> <p>ASUS Turbo LAN</p> <p>DTS Custom for GAMING Headsets</p> <p>Norton Anti-virus software (Free Trial for 60 days)</p> <p>WinRAR</p> <p>UEFI BIOS</p> <p>ASUS EZ DIY</p> <ul style="list-style-type: none"> - ASUS CrashFree BIOS 3 - ASUS EZ Flash 3 - ASUS UEFI BIOS EZ Mode
<p>BIOS</p>	<p>256 Mb Flash ROM, UEFI AMI BIOS</p>
<p>Manageability</p>	<p>WOL by PME, PXE</p>
<p>Operating System</p>	<p>Windows 10 64 - bit</p>
<p>Form Factor</p>	<p>ATX Form Factor</p> <p>12 inch x 9.6 inch (30.5 cm x 24.4 cm)</p>



Specifications are subject to change without notice. Refer to the ASUS website for the latest specifications.

Connectors with shared bandwidth

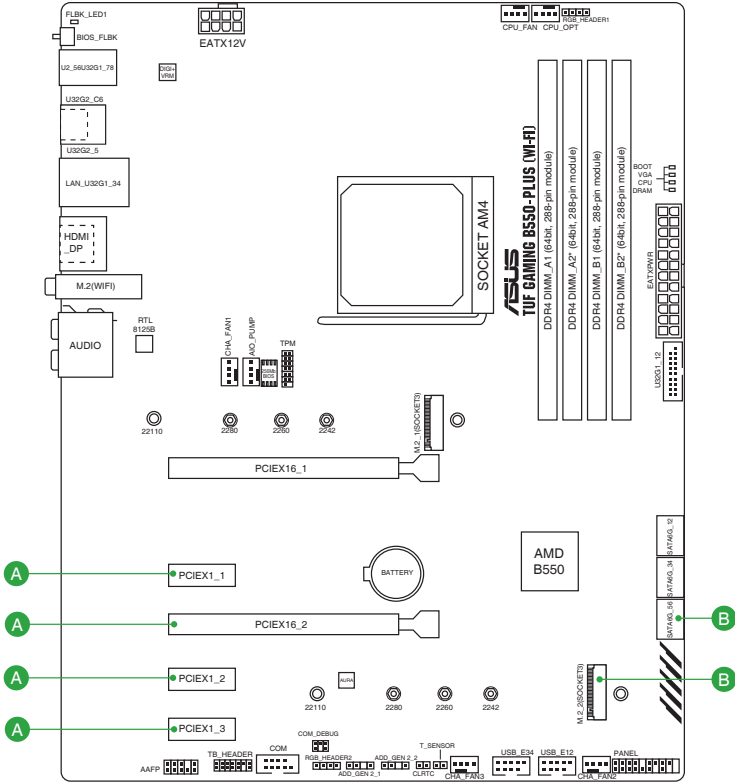

Configuration		1	2
A	PCIEX16_2	x4	x1
	PCIEX1_1	-	x1
	PCIEX1_2	-	x1
	PCIEX1_3	-	x1
Configuration		1	2
B	M.2_2	PCIe 3.0 x4 / SATA	-
	SATA6G_56	-	v



- PCIe 3.0 X16_2 runs x1 mode when any of the PCIe 3.0 x1 slots is occupied.
- M.2_2 shares bandwidth with SATA6G_56. When M.2_2 is populated, SATA6G_56 will be disabled.

Product Introduction

1

1.1 Before you proceed

Take note of the following precautions before you install motherboard components or change any motherboard settings.



- Unplug the power cord from the wall socket before touching any component.
- Before handling components, use a grounded wrist strap or touch a safely grounded object or a metal object, such as the power supply case, to avoid damaging them due to static electricity.
- Before you install or remove any component, ensure that the ATX power supply is switched off or the power cord is detached from the power supply. Failure to do so may cause severe damage to the motherboard, peripherals, or components.

1.2 Motherboard overview

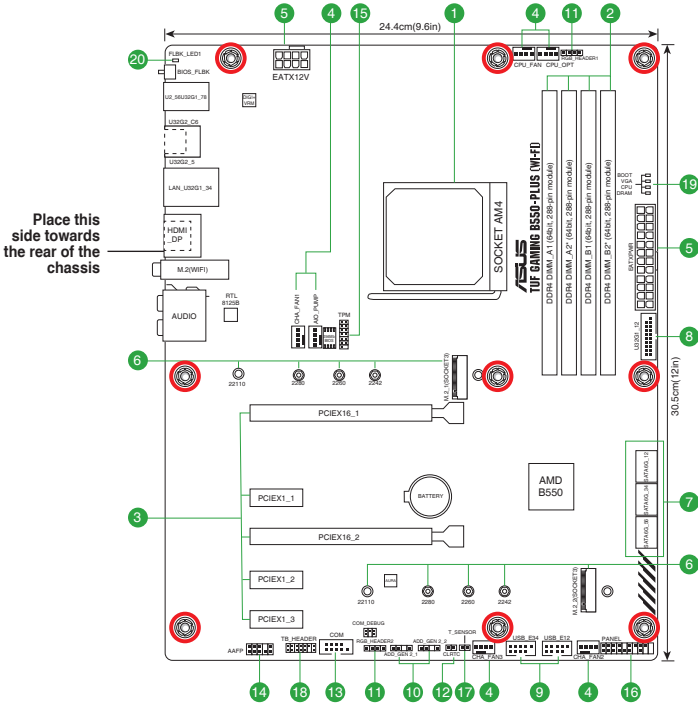

Unplug the power cord before installing or removing the motherboard. Failure to do so can cause you physical injury and damage motherboard components.

1.2.1 Layout contents

1. CPU socket

The motherboard comes with an AMD Socket AM4 designed for 3rd Gen AMD Ryzen™ and 3rd Gen AMD Ryzen™ with Radeon™ Graphics Processors.



For more details, refer to **Central Processing Unit (CPU)**.

2. DDR4 DIMM slots

The motherboard comes with Dual Inline Memory Modules (DIMM) slots designed for DDR4 (Double Data Rate 4) memory modules.



For more details, refer to **System memory**.

3. Expansion slots

This motherboard supports two PCIe x16 graphics cards and three PCIe 3.0 x1 network cards, SCSI cards and other cards that comply with the PCI Express specification. Please refer to the following table for the Hyper M.2 configuration.

Hyper M.2 x16 series card configuration

Slot	PCIe bifurcation settings in PCIe x16 slots with different Ryzen™ CPUs
PCIEX16_1	3 rd Gen AMD Ryzen™ Processors (Support PCIe Gen 4 SSDs)
	Supported SSDs
	4



- Hyper M.2 X16 series cards are sold separately.
- When using 3rd Gen AMD Ryzen™ Processors and a Hyper M.2 X16 series card with 4 M.2 SSDs, if you wish to connect a display, we suggest installing a VGA card to PCIe X16_2, which will run at x4.
- Set PCIEX16_1 to **[PCIe RAID Mode]** under BIOS settings to enable the Hyper M.2 X16 series card.

4. Fan headers

The Fan headers allow you to connect fans to cool the system.

Header	Max. Current	Max. Power	Default Speed	Shared Control
CPU_FAN	1A	12W	Q-Fan Controlled	A
CPU_OPT	1A	12W	Q-Fan Controlled	A
CHA_FAN1	1A	12W	Q-Fan Controlled	-
CHA_FAN2	1A	12W	Q-Fan Controlled	-
CHA_FAN3	1A	12W	Q-Fan Controlled	-

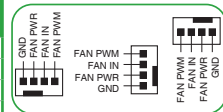

5. Power connectors

These Power connectors allow you to connect your motherboard to a power supply. The power supply plugs are designed to fit in only one orientation. Find the proper orientation and push down firmly until the power supply plugs are fully inserted.



Ensure to connect the 8-pin power plug.

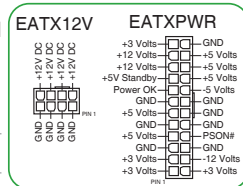



- For a fully configured system, we recommend that you use a power supply unit (PSU) that complies with ATX 12V Specification 2.0 (or later version) and provides a minimum power of 350 W.
- We recommend that you use a PSU with a higher power output when configuring a system with more power-consuming devices. The system may become unstable or may not boot up if the power is inadequate.
- If you are uncertain about the minimum power supply requirement for your system, we recommend you to refer to online resources for Power Supply Wattage Calculator.

6. M.2 Slots (Key M)

The M.2 slots allow you to install M.2 devices such as M.2 SSD modules.



- For 3rd Gen AMD Ryzen™ Processors, M.2_1 slot supports PCIe 4.0 x4 mode and SATA mode Key M design and type 2242/2260/2280/22110 storage devices.
- For 3rd Gen AMD Ryzen™ with Radeon™ Graphics Processors, M.2_1 slot supports PCIe 3.0 x4 mode and SATA mode Key M design and type 2242/2260/2280/22110 storage devices.
- For AMD B550 chipset, M.2_2 slot supports PCIe 3.0 x4 mode and SATA mode Key M design and type 2242/2260/2280/22110 storage devices.

7. SATA 6Gb/s ports

The SATA 6Gb/s ports allow you to connect SATA devices such as optical disc drives and hard disk drives via a SATA cable.

8. USB 3.2 Gen 1 header

The USB 3.2 Gen 1 header allows you to connect a USB 3.2 Gen 1 module for additional USB 3.2 Gen 1 ports. The USB 3.2 Gen 1 header provides data transfer speeds of up to 5 Gb/s.



The USB 3.2 Gen 1 module is purchased separately.

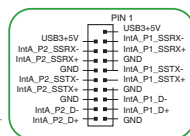

9. USB 2.0 headers

The USB 2.0 headers allow you to connect USB modules for additional USB 2.0 ports. The USB 2.0 headers provide data transfer speeds of up to 480 Mb/s.



DO NOT connect a 1394 cable to the USB connectors. Doing so will damage the motherboard!



The USB 2.0 module is purchased separately.

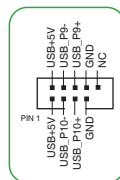

10. Aura Addressable Gen 2 headers

The Addressable Gen 2 headers allow you to connect individually addressable RGB WS2812B LED strips or WS2812B based LED strips.



The Addressable Gen 2 headers support WS2812B addressable RGB LED strips (5V/Data/Ground), with a maximum power rating of 3A (5V), and the addressable headers on this board can handle a combined maximum of 500 LEDs.

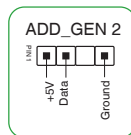



Before you install or remove any component, ensure that the power supply is switched off or the power cord is detached from the power supply. Failure to do so may cause severe damage to the motherboard, peripherals, or components.



- Actual lighting and color will vary with LED strip.
- If your LED strip does not light up, check if the addressable RGB LED strip is connected in the correct orientation, and the 5V connector is aligned with the 5V header on the motherboard.
- The addressable RGB LED strip will only light up when the system is powered on.
- The addressable RGB LED strip is purchased separately.

11. Aura RGB headers

The RGB headers allow you to connect RGB LED strips.



The RGB headers support 5050 RGB multi-color LED strips (12V/G/R/B), with a maximum power rating of 3A (12V), and no longer than 3 m.



Before you install or remove any component, ensure that the ATX power supply is switched off or the power cord is detached from the power supply. Failure to do so may cause severe damage to the motherboard, peripherals, or components.



- Actual lighting and color will vary with LED strip.
- If your LED strip does not light up, check if the RGB LED extension cable and the RGB LED strip are connected in the correct orientation, and the 12V connector is aligned with the 12V header on the motherboard.
- The LED strip will only light up when the system is powered on.
- The LED strip is purchased separately.

12. Clear CMOS header

This header allows you to clear the CMOS RTC RAM data of the system setup information such as date, time, and system passwords.

To erase the RTC RAM:

1. Turn OFF the computer and unplug the power cord.
2. Use a metal object such as a screwdriver to short the two pins.
3. Plug the power cord and turn ON the computer.
4. Hold down the key during the boot process and enter BIOS setup to re-enter data.

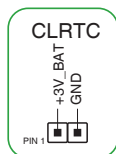

If the steps above do not help, remove the onboard battery and short the two pins again to clear the CMOS RTC RAM data. After clearing the CMOS, reinstall the battery.

13. COM Port header

This header is for a serial (COM) port. Connect the serial port module cable to this header, then install the module to a slot opening at the back of the system chassis.

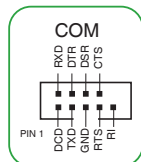

14. Front panel audio header

This header is for a chassis-mounted front panel audio I/O module that supports HD audio standard. Connect one end of the front panel audio I/O module cable to this header.



- We recommend that you connect a high-definition front panel audio module to this header to avail of the motherboard's high-definition audio capability.
- If you want to connect a high-definition front panel audio module to this header, set the Front Panel Type item in the BIOS setup to [HD Audio]. By default, this header is set to [HD Audio].

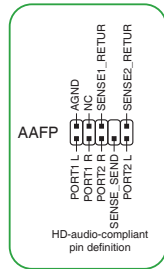

15. SPI TPM header

This header supports a Trusted Platform Module (TPM) system with a Serial Peripheral Interface (SPI), allowing you to securely store keys, digital certificates, passwords, and data. A TPM system also helps enhance network security, protects digital identities, and ensures platform integrity.

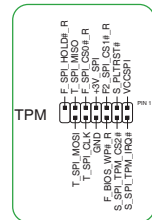

16. 20-5 pin System Panel header

This header supports several chassis-mounted functions.

• System power LED (2-pin PLED)

This 2-pin header is for the system power LED. Connect the chassis power LED cable to this header. The system power LED lights up when you turn on the system power, and blinks when the system is in sleep mode.

• Hard disk drive activity LED (2-pin HDD_LED)

This 2-pin header is for the HDD Activity LED. Connect the HDD Activity LED cable to this header. The HDD LED lights up or flashes when data is read from or written to the HDD.

• System warning speaker (4-pin SPEAKER)

This 4-pin header is for the chassis-mounted system warning speaker. The speaker allows you to hear system beeps and warnings.

• ATX power button/soft-off button (2-pin PWRSW)

This header is for the system power button. Pressing the power button turns the system on or puts the system in sleep or soft-off mode depending on the operating system settings. Pressing the power switch for more than four seconds while the system is ON turns the system OFF.

• Reset button (2-pin RESET)

This 2-pin header is for the chassis-mounted reset button for system reboot without turning off the system power.

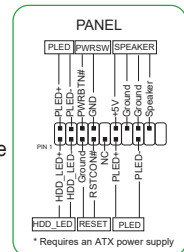

17. Thermal Sensor header

This header is for the thermistor cable that allows you to monitor the temperature of your motherboard's critical components and connected devices.

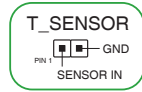

18. Thunderbolt header

This header is for the add-on Thunderbolt I/O card that supports Intel's Thunderbolt Technology, allowing you to connect up to six Thunderbolt-enabled devices and a DisplayPort-enabled display in a daisy-chain configuration.

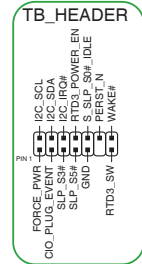

19. Q-LEDs

The Q-LEDs check key components (CPU, DRAM, VGA, and booting devices) during the motherboard booting process. If an error is found, the critical component's LED stays lit up until the problem is solved.



The Q-LEDs provide the most probable cause of an error code as a starting point for troubleshooting. The actual cause may vary from case to case.

20. BIOS FlashBack™ LED

The FlashBack™ LED lights up or blinks to indicate the status of the BIOS FlashBack™.



Scan the QR code for more information on BIOS FlashBack™ function.



1.2.2 Rear panel connectors

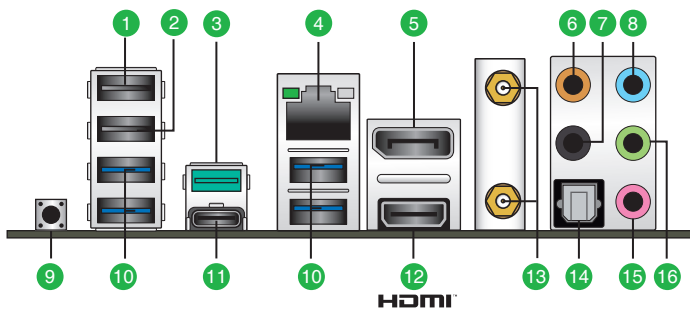

1. **USB 2.0 port.** This 4-pin Universal Serial Bus (USB) port is for USB 2.0 devices.
2. **USB 2.0 port with BIOS FlashBack™ function.** Insert a USB storage device to this USB 2.0 port to run BIOS FlashBack™.
3. **USB 3.2 Gen 2 (up to 10Gbps) port (teal blue, Type A).** This 9-pin Universal Serial Bus 3.2 (USB 3.2) port is for USB 3.2 Gen 2 devices.
4. **Ethernet port.** This port allows 2.5G Gigabit connection to a Local Area Network (LAN) through a network hub. Refer to the table below for the Ethernet port LED indications.

Realtek RTL8125B 2.5G Ethernet port LED indications

Activity Link LED		Speed LED	
Status	Description	Status	Description
OFF	No link	OFF	100 Mbps connection
GREEN	Linked	GREEN	2.5 Gbps connection
BLINKING	Data activity	ORANGE	1 Gbps / 100 Mbps / 10 Mbps connection

ACT/LINK LED

SPEED LED

LAN port

5. **DisplayPort.** This port is for a DisplayPort-compatible device.
6. **Center / Subwoofer port (orange).** This port connects the center/subwoofer speakers.
7. **Rear Speaker Out port (black).** This port connects the rear speakers in a 4 channel, 5.1 channel, or 7.1 channel audio configuration.
8. **Line In port (light blue).** This port connects the tape, CD, DVD player, or other audio sources.
9. **BIOS FlashBack™ button.** Press the BIOS FlashBack™ button for three seconds until the FlashBack™ LED blinks three times, indicating that the BIOS FlashBack™ function is enabled.
10. **USB 3.2 Gen 1 (up to 5Gbps) ports.** These 9-pin Universal Serial Bus (USB) ports connect to USB 3.2 Gen 1 devices.
11. **USB 3.2 Gen 2 (up to 10Gbps) port (USB Type-C®).** This 9-pin Universal Serial Bus 3.2 (USB 3.2) port is for USB 3.2 Gen 2 Type-C® devices.

12. **HDMI™ port.** This port is for a High-Definition Multimedia Interface (HDMI™) connector, and is HDCP compliant allowing playback of HD DVD, Blu-ray, and other protected content.

13. **Intel® Wi-Fi 6 AX200 ports.** These ports connect to a Wi-Fi antenna.



- Ensure that the ASUS 2x2 dual-band Wi-Fi antenna is securely installed to the Wi-Fi ports.
- Ensure that the antenna is at least 20 cm away from all persons.

14. **Optical S/PDIF Out port.** This port connects to the optical S/PDIF devices.

15. **Microphone port (pink).** This port connects a microphone.

16. **Line Out port (lime).** This port connects a headphone or a speaker. In 4-channel, 5.1-channel, and 7.1-channel configurations, the function of this port becomes Front Speaker Out.



Refer to the audio configuration table for the function of the audio ports in 2, 4, 5.1, or 7.1-channel configuration.

Audio 2, 4, 5.1 or 7.1-channel configuration

Port	Headset 2-channel	4-channel	5.1-channel	7.1-channel
Light Blue	Line In	Line In	Line In	Side Speaker Out
Lime	Line Out	Front Speaker Out	Front Speaker Out	Front Speaker Out
Pink	Mic In	Mic In	Mic In	Mic In
Orange	–	–	Center/Subwoofer	Center/Subwoofer
Black	–	Rear Speaker Out	Rear Speaker Out	Rear Speaker Out

1.3 Central Processing Unit (CPU)

This motherboard comes with an AMD Socket AM4 designed for 3rd Gen AMD Ryzen™ and 3rd Gen AMD Ryzen™ with Radeon™ Graphics Processors.

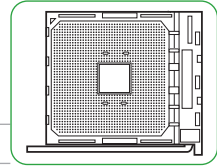

Unplug all power cables before installing the CPU.



The AM4 socket has a different pinout design. Ensure that you use a CPU designed for the AM4 socket. The CPU fits in only one correct orientation. **DO NOT** force the CPU into the socket to prevent bending the connectors on the socket and damaging the CPU!

Installing the CPU

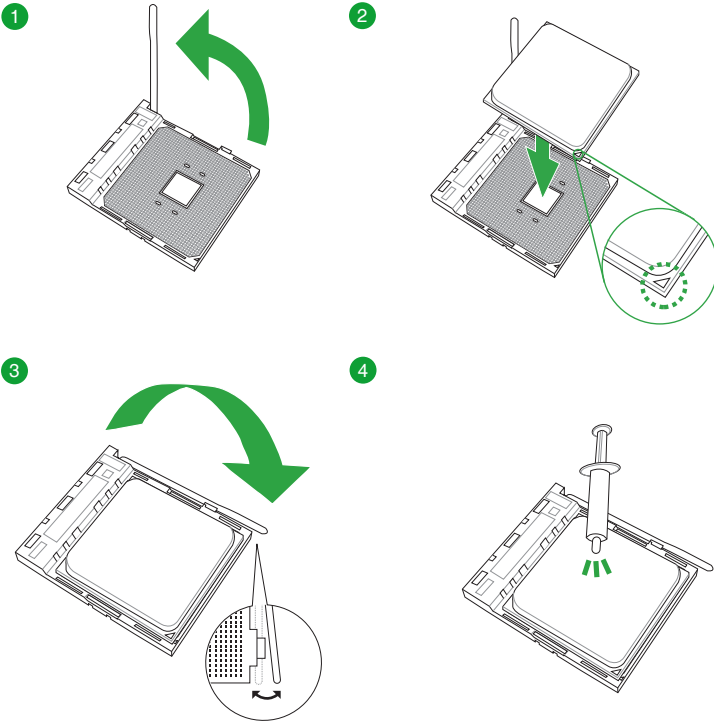

Apply the Thermal Interface Material to the CPU heatsink and CPU before you install the heatsink and fan if necessary.

1.4 System memory

This motherboard comes with four Double Data Rate 4 (DDR4) Dual Inline Memory Module (DIMM) sockets. The figure illustrates the location of the DDR4 DIMM sockets:

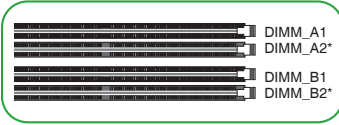

Channel	Sockets
Channel A	DIMM_A1 & DIMM_A2*
Channel B	DIMM_B1 & DIMM_B2*



- You may install varying memory sizes in Channel A and Channel B. The system maps the total size of the lower-sized channel for the dual-channel configuration. Any excess memory from the higher-sized channel is then mapped for single-channel operation.
- Always install DIMMs with the same CAS latency. For optimal compatibility, we recommend that you install memory modules of the same version or date code (D/C) from the same vendor. Check with the retailer to get the correct memory modules.
- A DDR4 memory module is notched differently from a DDR, DDR2, or DDR3 module. DO NOT install a DDR, DDR2, or DDR3 memory module to the DDR4 slot.



- The default memory operation frequency is dependent on its Serial Presence Detect (SPD), which is the standard way of accessing information from a memory module. Under the default state, some memory modules for overclocking may operate at a lower frequency than the vendor-marked value.
- For system stability, use a more efficient memory cooling system to support a full memory load.
- Refer to www.asus.com for the latest Memory QVL (Qualified Vendors Lists).

Recommended memory configurations

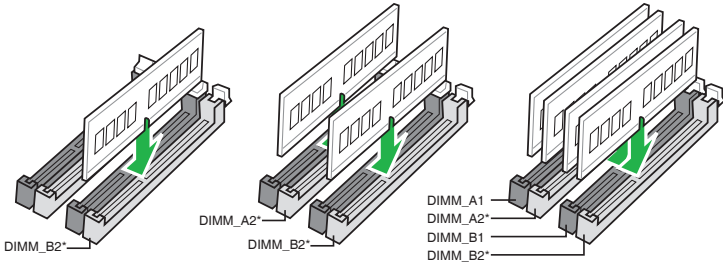

Installing a DIMM

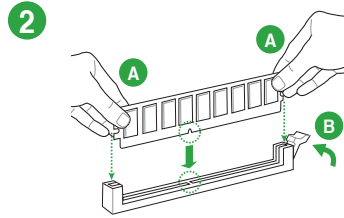
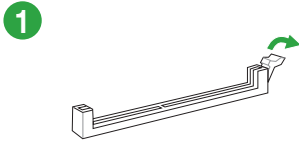

To remove a DIMM

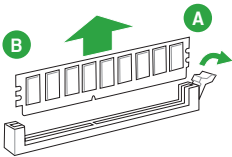

1.5 M.2 installation

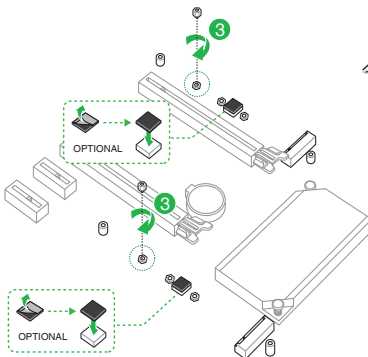
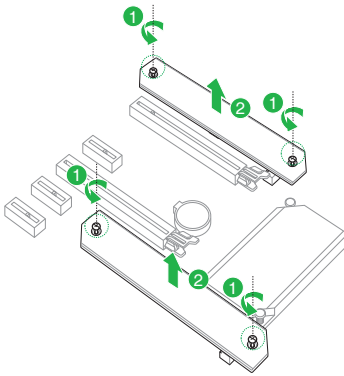

- Ensure to install the bundled M.2 rubber pad before installing your single sided M.2 storage device.
- DO NOT install the bundled M.2 rubber pads when installing a double-sided M.2 storage device. The rubber pad installed by default is compatible with double sided M.2 storage devices.
- The diagrams in this section are for reference only.

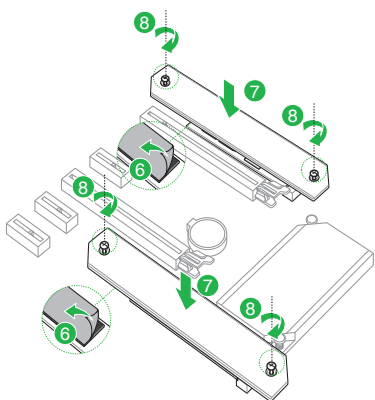
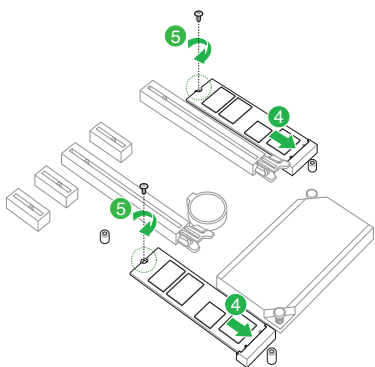

The M.2 is purchased separately.

BIOS and RAID Support

2

2.1 Knowing BIOS



The new ASUS UEFI BIOS is a Unified Extensible Interface that complies with UEFI architecture, offering a user-friendly interface that goes beyond the traditional keyboard-only BIOS controls to enable a more flexible and convenient mouse input. You can easily navigate the new UEFI BIOS with the same smoothness as your operating system. The term "BIOS" in this user manual refers to "UEFI BIOS" unless otherwise specified.

BIOS (Basic Input and Output System) stores system hardware settings such as storage device configuration, overclocking settings, advanced power management, and boot device configuration that are needed for system startup in the motherboard CMOS. In normal circumstances, the default BIOS settings apply to most conditions to ensure optimal performance. **DO NOT change the default BIOS settings** except in the following circumstances:

- An error message appears on the screen during the system bootup and requests you to run the BIOS Setup.
- You have installed a new system component that requires further BIOS settings or update.



Inappropriate BIOS settings may result in instability or boot failure. **We strongly recommend that you change the BIOS settings only with the help of a trained service personnel.**



- When downloading or updating the BIOS file, rename it as **TGB550PW.CAP** for this motherboard.
- BIOS settings and options may vary due to different BIOS release versions. Please refer to the latest BIOS version for settings and options.



For more information on BIOS configurations, please refer to <https://www.asus.com/support>, or download the BIOS manual by scanning the QR code.



2.2 BIOS Setup program

Use the BIOS Setup to update the BIOS or configure its parameters. The BIOS screen includes navigation keys and brief onscreen help to guide you in using the BIOS Setup program.

Entering BIOS at startup

To enter BIOS Setup at startup, press <Delete> or <F2> during the Power-On Self Test (POST). If you do not press <Delete> or <F2>, POST continues with its routines.

Entering BIOS Setup after POST

To enter BIOS Setup after POST:

- Press <Ctrl>+<Alt>+<Delete> simultaneously.
- Press the reset button on the system chassis.
- Press the power button to turn the system off then back on. Do this option only if you failed to enter BIOS Setup using the first two options.

After doing either of the three options, press <Delete> key to enter BIOS.



-
- Ensure that a USB mouse is connected to your motherboard if you want to use the mouse to control the BIOS setup program.
 - If the system becomes unstable after changing any BIOS setting, load the default settings to ensure system compatibility and stability. Select the **Load Optimized Defaults** item under the **Exit** menu or press hotkey <F5>.
 - If the system fails to boot after changing any BIOS setting, try to clear the CMOS and reset the motherboard to the default value.
 - The BIOS setup program does not support Bluetooth devices.
-

BIOS menu screen

The BIOS Setup program can be used under two modes: **EZ Mode** and **Advanced Mode**. You can change modes from **Setup Mode** in **Boot menu** or by pressing the <F7> hotkey.

2.3 ASUS EZ Flash 3

The ASUS EZ Flash 3 feature allows you to update the BIOS without using an OS-based utility.



Ensure to load the BIOS default settings to ensure system compatibility and stability. Select the **Load Optimized Defaults** item under the **Exit** menu or press hotkey <F5>.

To update the BIOS by USB:



- This function can support devices such as a USB flash disk with FAT 32/16 format and single partition only.
 - DO NOT shut down or reset the system while updating the BIOS to prevent system boot failure!
-

1. Insert the USB flash disk that contains the latest BIOS file to the USB port.
2. Enter the Advanced Mode of the BIOS setup program. Go to the **Tool** menu to select **ASUS EZ Flash 3 Utility** and press <Enter>.
3. Select **via Storage Device(s)**.
4. Press <Tab> to switch to the **Drive** field.
5. Press the Up/Down arrow keys to find the USB flash disk that contains the latest BIOS, and then press <Enter>.
6. Press <Tab> to switch to the **Folder** field.
7. Press the Up/Down arrow keys to find the BIOS file, and then press <Enter> to perform the BIOS update process. Reboot the system when the update process is done.

2.4 ASUS CrashFree BIOS 3

The ASUS CrashFree BIOS 3 utility is an auto recovery tool that allows you to restore the BIOS file when it fails or gets corrupted during the updating process. You can restore a corrupted BIOS file using a USB flash drive that contains the BIOS file.



If you want to use the latest BIOS file, download the file at <https://www.asus.com/support/> and save it to a USB flash drive.

Recovering the BIOS

To recover the BIOS:

1. Turn on the system.
2. Insert the USB flash drive containing the BIOS file to the USB port.
3. The utility automatically checks the devices for the BIOS file. When found, the utility reads the BIOS file and enters ASUS EZ Flash 3 automatically.
4. The system requires you to enter BIOS Setup to recover the BIOS setting. To ensure system compatibility and stability, we recommend that you press <F5> to load default BIOS values.



DO NOT shut down or reset the system while updating the BIOS! Doing so can cause system boot failure!

2.5 RAID configurations

The motherboard comes with the RaidXpert2 Configuration Utility that supports RAID 0, RAID 1 and RAID 10 configuration.



For more information on configuring your RAID sets, please refer to the **RAID Configuration Guide** which you can find at <https://www.asus.com/support>, or by scanning the QR code.



RAID definitions

RAID 0 (Data striping) optimizes two identical hard disk drives to read and write data in parallel, interleaved stacks. Two hard disks perform the same work as a single drive but at a sustained data transfer rate, double that of a single disk alone, thus improving data access and storage. Use of two new identical hard disk drives is required for this setup.

RAID 1 (Data mirroring) copies and maintains an identical image of data from one drive to a second drive. If one drive fails, the disk array management software directs all applications to the surviving drive as it contains a complete copy of the data in the other drive. This RAID configuration provides data protection and increases fault tolerance to the entire system. Use two new drives or use an existing drive and a new drive for this setup. The new drive must be of the same size or larger than the existing drive.

RAID 10 is data striping and data mirroring combined without parity (redundancy data) having to be calculated and written. With the RAID 10 configuration you get all the benefits of both RAID 0 and RAID 1 configurations. Use four new hard disk drives or use an existing drive and three new drives for this setup.

Appendix

Notices

FCC Compliance Information

Responsible Party: Asus Computer International
Address: 48720 Kato Rd., Fremont, CA 94538, USA
Phone / Fax No: (510)739-3777 / (510)608-4555

Identification of the assembled product: INTEL® WI-FI 6 AX200

Identification of the modular components used in the assembly:

Model Name: **INTEL® WI-FI 6 AX200** FCC ID: **PD9AX200NG**

This device complies with part 15 of the FCC Rules. Operation is subject to the following two conditions: (1) This device may not cause harmful interference, and (2) this device must accept any interference received, including interference that may cause undesired operation.

This equipment has been tested and found to comply with the limits for a Class B digital device, pursuant to part 15 of the FCC Rules. These limits are designed to provide reasonable protection against harmful interference in a residential installation. This equipment generates, uses and can radiate radio frequency energy and, if not installed and used in accordance with the instructions, may cause harmful interference to radio communications. However, there is no guarantee that interference will not occur in a particular installation. If this equipment does cause harmful interference to radio or television reception, which can be determined by turning the equipment off and on, the user is encouraged to try to correct the interference by one or more of the following measures:

- Reorient or relocate the receiving antenna.
- Increase the separation between the equipment and receiver.
- Connect the equipment into an outlet on a circuit different from that to which the receiver is connected.
- Consult the dealer or an experienced radio/TV technician for help.

RF exposure warning

This equipment must be installed and operated in accordance with provided instructions and the antenna(s) used for this transmitter must be installed to provide a separation distance of at least 20 cm from all persons and must not be co-located or operating in conjunction with any other antenna or transmitter. End-users and installers must be provide with antenna installation instructions and transmitter operating conditions for satisfying RF exposure compliance.

Compliance Statement of Innovation, Science and Economic Development Canada (ISED)

This device complies with Innovation, Science and Economic Development Canada licence exempt RSS standard(s). Operation is subject to the following two conditions: (1) this device may not cause interference, and (2) this device must accept any interference, including interference that may cause undesired operation of the device.

Operation in the band 5150–5250 MHz is only for indoor use to reduce the potential for harmful interference to co-channel mobile satellite systems.

CAN ICES-3(B)/NMB-3(B)

Déclaration de conformité de Innovation, Sciences et Développement économique Canada (ISED)

Le présent appareil est conforme aux CNR d'Innovation, Sciences et Développement économique Canada applicables aux appareils radio exempts de licence. L'exploitation est autorisée aux deux conditions suivantes : (1) l'appareil ne doit pas produire de brouillage, et (2) l'utilisateur de l'appareil doit accepter tout brouillage radioélectrique subi, même si le brouillage est susceptible d'en compromettre le fonctionnement.

La bande 5150–5250 MHz est réservée uniquement pour une utilisation à l'intérieur afin de réduire les risques de brouillage préjudiciable aux systèmes de satellites mobiles utilisant les mêmes canaux.

CAN ICES-3(B)/NMB-3(B)

VCCI: Japan Compliance Statement

Class B ITE

この装置は、クラスB情報技術装置です。この装置は、家庭環境で使用することを目的としていますが、この装置がラジオやテレビジョン受信機に近接して使用されると、受信障害を引き起こすことがあります。

取扱説明書に従って正しい取り扱いをして下さい。

V C C I - B

KC: Korea Warning Statement

B급 기기 (가정용 방송통신기자재)

이 기기는 가정용(B급) 전자파적합기기로서 주로 가정에서 사용하는 것을 목적으로 하며, 모든 지역에서 사용할 수 있습니다.

*당해 무선설비는 전파혼신 가능성이 있으므로 인명안전과 관련된 서비스는 할 수 없습니다.

Google™ License Terms

Copyright© 2020 Google Inc. All Rights Reserved.

Licensed under the Apache License, Version 2.0 (the "License"); you may not use this file except in compliance with the License. You may obtain a copy of the License at:

<http://www.apache.org/licenses/LICENSE-2.0>

Unless required by applicable law or agreed to in writing, software distributed under the License is distributed on an "AS IS" BASIS, WITHOUT WARRANTIES OR CONDITIONS OF ANY KIND, either express or implied.

See the License for the specific language governing permissions and limitations under the License.

NCC: Taiwan Wireless Statement

經型式認證合格之低功率射頻電機，非經許可，公司、商號或使用者均不得擅自變更頻率、加大功率或變更原設計之特性及功能。低功率射頻電機之使用不得影響飛航安全及干擾合法通信；經發現有干擾現象時，應立即停用，並改善至無干擾時方得繼續使用。前項合法通信，指依電信法規定作業之無線電通信。低功率射頻電機須忍受合法通信或工業、科學及醫療用電波輻射性電機設備之干擾。

應避免影響附近雷達系統之操作。

Japan RF Equipment Statement

屋外での使用について

本製品は、5GHz帯域での通信に対応しています。電波法の定めにより5.2GHz、5.3GHz帯域の電波は屋外で使用が禁じられています。

法律および規制遵守

本製品は電波法及びこれに基づく命令の定めるところに従い使用してください。日本国外では、その国の法律または規制により、本製品の使用ができないことがあります。このような国では、本製品を運用した結果、罰せられることがあります。当社は一切責任を負いかねますのでご了承ください。

Précautions d'emploi de l'appareil :

- Soyez particulièrement vigilant quant à votre sécurité lors de l'utilisation de cet appareil dans certains lieux (les avions, les aéroports, les hôpitaux, les stations-service et les garages professionnels).
- Évitez d'utiliser cet appareil à proximité de dispositifs médicaux implantés. Si vous portez un implant électronique (stimulateurs cardiaques, pompes à insuline, neurostimulateurs...), veuillez impérativement respecter une distance minimale de 15 centimètres entre cet appareil et l'implant pour réduire les risques d'interférence.
- Utilisez cet appareil dans de bonnes conditions de réception pour minimiser le niveau de rayonnement. Ce n'est pas toujours le cas dans certaines zones ou situations, notamment dans les parkings souterrains, dans les ascenseurs, en train ou en voiture ou tout simplement dans un secteur mal couvert par le réseau.
- Tenez cet appareil à distance du ventre des femmes enceintes et du bas-ventre des adolescents.

Declaration of compliance for product environmental regulation

ASUS follows the green design concept to design and manufacture our products, and makes sure that each stage of the product life cycle of ASUS product is in line with global environmental regulations. In addition, ASUS disclose the relevant information based on regulation requirements.

Please refer to <http://csr.asus.com/Compliance.htm> for information disclosure based on regulation requirements ASUS is complied with:

EU REACH and Article 33

Complying with the REACH (Registration, Evaluation, Authorisation, and Restriction of Chemicals) regulatory framework, we published the chemical substances in our products at ASUS REACH website at <http://csr.asus.com/english/REACH.htm>.

EU RoHS

This product complies with the EU RoHS Directive. For more details, see <http://csr.asus.com/english/article.aspx?id=35>

India RoHS

This product complies with the “India E-Waste (Management) Rules, 2016” and prohibits use of lead, mercury, hexavalent chromium, polybrominated biphenyls (PBBs) and polybrominated diphenyl ethers (PBDEs) in concentrations exceeding 0.1% by weight in homogenous materials and 0.01% by weight in homogenous materials for cadmium, except for the exemptions listed in Schedule II of the Rule.

Vietnam RoHS

ASUS products sold in Vietnam, on or after September 23, 2011, meet the requirements of the Vietnam Circular 30/2011/TT-BCT.

Các sản phẩm ASUS bán tại Việt Nam, vào ngày 23 tháng 9 năm 2011 trở về sau, đều phải đáp ứng các yêu cầu của Thông tư 30/2011/TT-BCT của Việt Nam.

Turkey RoHS

AEEEE Yönetmeliğine Uygundur

ASUS Recycling/Takeback Services

ASUS recycling and takeback programs come from our commitment to the highest standards for protecting our environment. We believe in providing solutions for you to be able to responsibly recycle our products, batteries, other components as well as the packaging materials. Please go to <http://csr.asus.com/english/Takeback.htm> for detailed recycling information in different regions.



DO NOT throw the motherboard in municipal waste. This product has been designed to enable proper reuse of parts and recycling. This symbol of the crossed out wheeled bin indicates that the product (electrical and electronic equipment) should not be placed in municipal waste. Check local regulations for disposal of electronic products.



DO NOT throw the mercury-containing button cell battery in municipal waste. This symbol of the crossed out wheeled bin indicates that the battery should not be placed in municipal waste.

Regional notice for California



WARNING

Cancer and Reproductive Harm -
www.P65Warnings.ca.gov

Simplified EU Declaration of Conformity

ASUSTek Computer Inc. hereby declares that this device is in compliance with the essential requirements and other relevant provisions of Directive 2014/53/EU. Full text of EU declaration of conformity is available at <https://www.asus.com/support/>

The WiFi operating in the band 5150-5350MHz shall be restricted to indoor use for countries listed in the table below:

Déclaration simplifiée de conformité de l'UE

ASUSTek Computer Inc. déclare par la présente que cet appareil est conforme aux critères essentiels et autres clauses pertinentes de la directive 2014/53/UE. La déclaration de conformité de l'UE peut être téléchargée à partir du site internet suivant : <https://www.asus.com/support/>

Dans la plage de fréquence 5150-5350 MHz, le Wi-Fi est restreint à une utilisation en intérieur dans les pays listés dans le tableau ci-dessous:

Vereinfachte EU-Konformitätserklärung

ASUSTek COMPUTER INC erklärt hiermit, dass dieses Gerät mit den grundlegenden Anforderungen und anderen relevanten Bestimmungen der Richtlinie 2014/53/EU übereinstimmt. Der gesamte Text der EU-Konformitätserklärung ist verfügbar unter: <https://www.asus.com/support/>

Der WLAN-Betrieb im Band von 5150-5350 MHz ist für die in der untenen Tabelle aufgeführten Länder auf den Innenbereich beschränkt:

Dichiarazione di conformità UE semplificata

ASUSTek Computer Inc. con la presente dichiara che questo dispositivo è conforme ai requisiti essenziali e alle altre disposizioni pertinenti con la direttiva 2014/53/UE. Il testo completo della dichiarazione di conformità UE è disponibile all'indirizzo: <https://www.asus.com/support/>

L'utilizzo della rete Wi-Fi con frequenza compresa nell'intervallo 5150-5350MHz deve essere limitato all'interno degli edifici per i paesi presenti nella seguente tabella:

Упрощенное заявление о соответствии европейской директиве

ASUSTek Computer Inc. заявляет, что устройство соответствует основным требованиям и другим соответствующим условиям директивы 2014/53/UE. Полный текст декларации соответствия ЕС доступен на <https://www.asus.com/support/>

Работа Wi-Fi в диапазоне частот 5150-5350 должна быть ограничена использованием в помещениях для стран, перечисленных в таблице ниже:

اعلان التوافق المبسط عن الاتحاد الأوروبي

تقر شركة ASUSTek Computer Inc أن هذا الجهاز يتوافق مع المتطلبات الأساسية والأحكام الأخرى ذات الصلة الخاصة بتوجيه 2014/53/UE. يتوفر النص الكامل لإعلان التوافق المبسط عن الاتحاد الأوروبي على: <https://www.asus.com/support/>

يجب حصر استخدام WiFi العاملة بـ 5150-5350 ميجا هرتز على الاستخدام المنزلي للبلدان المترجمة بالجدول.

Опростена декларация за съответствие на ЕС

С настоящото ASUSTek Computer Inc. декларира, че това устройство е в съответствие със съществените изисквания и другите приложения постановления на свързаната Директива 2014/53/ЕС. Пълният текст на ЕС декларация за съвместимост е достъпен на адрес <https://www.asus.com/support/>

WiFi, работеща в диапазон 5150-5350MHz, трябва да се ограничи до употреба на закрито за страните, посочени в таблицата по-долу:

Declaração de Conformidade UE Simplificada

ASUSTek Computer Inc. declara que este dispositivo está em conformidade com os requisitos essenciais e outras disposições relevantes relacionadas às diretivas 2014/53/UE. O texto completo da declaração de conformidade CE está disponível em <https://www.asus.com/support/>

O WiFi operando na banda 5150-5350MHz deve ser restrito para uso interno para os países listados na tabela abaixo:

Pojednostavljena EU izjava o sukladnosti

ASUSTek Computer Inc. ovim izjavljuje da je ovaj uređaj sukladan s bitnim zahtjevima i ostalim odgovarajućim odredbama direktive 2014/53/UE. Cijeli tekst EU izjave o sukladnosti dostupan je na <https://www.asus.com/support/>

WiFi koji radi na opsegu frekvencija 5150-5350 MHz bit će ograničen na upotrebu u zatvorenom prostoru u zemljama na donjem popisu:

Zjednodušené prohlášení o shodě EU

Společnost ASUSTek Computer Inc. tímto prohlašuje, že toto zařízení splňuje základní požadavky a další příslušná ustanovení směrnice 2014/53/UE. Plné znění prohlášení o shodě EU je k dispozici na adrese <https://www.asus.com/support/>

V zemích uvedených v tabulce je provoz sítě Wi-Fi ve frekvenčním rozsahu 5 150 - 5 350 MHz povolen pouze ve vnitřních prostorech:

Forenklet EU-ovenstemmelseserklæring

ASUSTek Computer Inc. erklærer hermed at denne enhed er i overensstemmelse med hovedkravene og øvrige relevante bestemmelser i direktivet 2014/53/UE. Hele EU-ovenstemmelseserklæringen kan findes på <https://www.asus.com/support/>

Wi-Fi, der bruger 5150-5350 MHz skal begrænses til indendørs brug i lande, der er anført i tabellen:

Vereenvoudigd EU-conformiteitsverklaring

ASUSTek Computer Inc. verklaart hierbij dat dit apparaat voldoet aan de essentiële vereisten en andere relevante bepalingen van Richtlijn 2014/53/UE. De volledige tekst van de EU-conformiteitsverklaring is beschikbaar op <https://www.asus.com/support/>

De WiFi op 5150-5350MHz zal beperkt zijn tot binnengebruik voor in de tabel vermelde landen:

Lihtstatud EU vastavusdeklaratsioon

Käesolevaga kinnitab ASUSTek Computer Inc. et seade vastab direktiivi 2014/53/EL olulistele nõuetele ja teistele asjakohastele sätetele. EU vastavusdeklaratsiooni täisteksti on saadaval veebisaidil <https://www.asus.com/support/>

Sagedusvahemikus 5150-5350 MHz töötava WiFi kasutamise on järgmistes riikides lubatud ainult siseruumides:

Eurooppa - EY:n vaatimustenmukaisuusvakuutus

ASUSTek Computer Inc. ilmoittaa täten, että tämä laite on direktiivin 2014/53/UE olennaisien vaatimusten ja muiden asiaankuuluvien lisäysten mukainen. Koko EY:n vaatimustenmukaisuusvakuutuksen teksti on luettavissa osoitteessa <https://www.asus.com/support/>

5 150 - 5 350 MHz:n taajuudella toimiva WiFi on rajoitettu sisäkäyttöön taulukossa luetellussa maissa:

تیخت ای نسخہ سادہ شدہ بیانیہ تصدیقہ اروپا

ASUSTek Computer Inc. در اینجا اعلام می کند که این دستگاه با نیازهای اساسی و سایر مقررات مربوط به بیانه 2014/53/UE، مطابقت دارد. متن کامل پروژ برای این بیانه تصدیقہ اروپا در این آدرس موجود است: <https://www.asus.com/support/>

استفاده از شبکه بی سیم 5150-5350 مگاهرتز برای WiFi باید برای استفاده در فضای داخلی ساختمان برای کشورهای فهرست شده در جدول، محدود شود.

Απλοποιημένη Δήλωση Συμμόρφωσης ΕΕ

Διό του παρόντος η ASUSTek Computer Inc. δηλώνει ότι αυτή η συσκευή είναι σύμμορη με τις βασικές προϋποθέσεις και άλλες ουσιαστικές διατάξεις της Οδηγίας 2014/53/ΕΕ. Το πλήρες κείμενο της δήλωσης συμμόρφωσης της ΕΕ είναι διαθέσιμο στη διεύθυνση <https://www.asus.com/support/>

To WiFi που λειτουργεί στη ζώνη 5150-5350MHz περιορίζεται για χρήση σε εσωτερικούς χώρους για τις χώρες που αναφέρονται στον παρακάτω πίνακα:

הגדרת האימות הרגולטורית מוקדמת עבור האיחוד האירופי

ASUSTek Computer Inc. מצהירה בזאת כי משיר זה תומך לדרישות החיוביות ולשאר הסעיפים הרלוונטיים של תקנה 2014/53/UE. ניתן לקרוא את הנוסח המלא של ההגדרת האימות הרגולטורית עבור האיחוד האירופי בכתובת: <https://www.asus.com/support/>

יש להגביל שימוש Wi-Fi הפועלת ברצועת התדרים 5150-5350MHz לשימוש בתוך מבנים סגורים בארצות הברית בשימה האר:

Egyszerűsített EU megfelelési nyilatkozatok

Az ASUSTek Computer Inc. ezennel kijelenti, hogy ez az eszköz megfelel az 2014/53/EU sz. irányelv alapvető követelményeinek és egyéb vonatkozó rendelkezésének. Az EU megfelelési nyilatkozat teljes szövegét a következő weboldalon tekintheti meg: <https://www.asus.com/support/>

Az 5150-5350 MHz-es sávban működő Wi-Fi beltéri használatra kell korlátozni az alábbi táblázatban felsorolt országokban:

Pernyataan Kesesuaian UE yang Disederhanakan

ASUSTek Computer Inc. dengan ini menyatakan bahwa perangkat ini memenuhi persyaratan utama dan ketentuan relevan lainnya yang terdapat pada Petunjuk 2014/53/UE. Teks lengkap pernyataan kesesuaian EU tersedia di: <https://www.asus.com/support/>

WiFi yang Beroperasi pada 5150-5350 MHz akan terbatas untuk penggunaan dalam ruangan di negara yang tercantum dalam tabel

Vienkāršota ES atbilstības paziņojums

ASUSTek Computer Inc. ar šo paziņo, ka šī ierīce atbilst Direktīvas 2014/53/ES būtiskajām prasībām un citiem citiem saistošajiem nosacījumiem. Pilns ES atbilstības paziņojuma teksts pieejams šeit: <https://www.asus.com/support/>

Wi-Fi darbība 5150–5350 MHz ir jāierobežo lietošanai telpās valstīs, kuras norādītas tālāk.

Supraprastina ES atitikties deklaracija

Šiame dokumente bendrovė „ASUSTek Computer Inc.“ pareiškia, kad šis prietaisas atitinka pagrindinius reikalavimus ir kitas susijusias Direktyvos 2014/53/ES nuostatas. Visas ES atitikties deklaracijos tekstas pateikiamas čia: <https://www.asus.com/support/>

Toliau nurodytose šalyse „WiFi“ ryšiu, veikiančiu 5 150–5 350 MHz dažniu juostoje, galima naudotis tik patalpose:

Ovaj uređaj može da se koristi u državama navedenim ispod:

Förenklad EU-samsvarserklæring

ASUSTek Computer Inc. erklærer herved at denne enheten er i samsvar med hovedsakelige krav og andre relevante forskrifter i direktivet 2014/53/EU.

Fullstendig tekst for EU-samsvarserklæring finnes på: <https://www.asus.com/support/>

Wi-Fi-området 5150–5350 MHz skal begrenses til innendørs bruk for landene som er oppført i tabellen:

Uproszczone deklaracja zgodności UE

Firma ASUSTek Computer Inc. niniejszym oświadczają, że urządzenie to jest zgodne z zasadniczymi wymogami i innymi właściwymi postanowieniami dyrektywy 2014/53/EU. Pełny tekst deklaracji zgodności UE jest dostępny pod adresem <https://www.asus.com/support/>

W krajach wymienionych w tabeli działanie sieci Wi-Fi w paśmie 5150–5350 MHz powinno być ograniczone wyłącznie do pomieszczeń:

Declaração de Conformidade Simplificada da UE

A ASUSTek Computer Inc. declara que este dispositivo está em conformidade com os requisitos essenciais e outras disposições relevantes da Diretiva 2014/53/UE. O texto integral da declaração de conformidade da UE está disponível em <https://www.asus.com/support/>

A utilização das frequências WiFi de 5150 a 5350MHz está restrita a ambientes interiores nos países apresentados na tabela:

Declaratie de conformitate UE, versiune simplificată

Prin prezenta, ASUSTek Computer Inc. declară că acest dispozitiv este în conformitate cu regulamentele esențiale și cu celelalte prevederi relevante ale Directivei 2014/53/UE. Textul complet al declarației de conformitate UE este disponibil la adresa <https://www.asus.com/support/>

Pentru țările listate în tabelul de mai jos, rețelele WiFi care funcționează în banda de frecvență de 5.150-5.350 MHz trebuie utilizate doar în interior:

Pojednostavljena Deklaracija o uslagšenosti EU

ASUSTek Computer Inc. ovim izjavljuje da je ovaj uređaj uslagšen sa osnovnim zahtevima i drugim relevantnim odredbama Direktive 2014/53/EU. Geo tekst Deklaracije o uslagšenosti EU dostupan je na lokaciji <https://www.asus.com/support/>

WiFi koji radi u frekventnom opsegu od 5150 MHz do 5350 MHz ograničen je isključivo na upotrebu u zatvorenom prostoru za zemlje navedene u tabeli ispod:

Zjednodušené vyhlásenie o zhode platné pre EÚ

Spoločnosť ASUSTek Computer Inc. týmto vyhlasuje, že toto zariadenie je v súlade so základnými požiadavkami a ďalšími príslušnými ustanoveniami smernice č. 2014/53/EÚ. Plné znenie vyhlásenia o zhode pre EÚ je k dispozícii na lokalite <https://www.asus.com/support/>

Činnosť WiFi v pásme 5150 – 5350 MHz bude obmedzená na použitie vo vnútornom prostredí pre krajiny uvedené v tabuľke nižšie:

Poenostavljena izjava EU o skladnosti

ASUSTek Computer Inc. tukaj izjavlja, da je ta naprava skladna s temeljnimi zahtevami in drugimi relevantnimi določili Direktive 2014/53/EU. Polno besedilo izjave EU o skladnosti je na voljo na <https://www.asus.com/support/>

WiFi, ki deluje v pasovnem območju 5150–5350 MHz, mora biti v državah, navedenih v spodnjem seznamu, omejen na notranjo uporabo:

Declaración de conformidad simplificada para la UE

Por la presente, ASUSTek Computer Inc. declara que este dispositivo cumple los requisitos básicos y otras disposiciones pertinentes de la directiva 2014/53/UE. En <https://www.asus.com/support/> está disponible el texto completo de la declaración de conformidad para la UE.

La conexión WiFi con una frecuencia de funcionamiento de 5150-5350 MHz se restringirá al uso en interiores para los países enumerados en la tabla:

Förenklad EU-försäkran om överensstämmelse

ASUSTek Computer Inc. deklarerar härmed att denna enhet överensstämmer med de grundläggande kraven och andra relevanta bestämmelser i direktiv 2014/53/EU. Fullständig text av EU-försäkran om överensstämmelse finns på <https://www.asus.com/support/>

WiFi som används 5150-5350 MHz kommer att begränsas för användning inomhus i de länder som anges i tabellen:

ประกาศเกี่ยวกับความสอดคล้องของสหภาพยุโรปแบบย่อ

ASUSTek Computer Inc. ขอประกาศในที่นี้ว่าอุปกรณ์มีความสอดคล้องกับข้อกำหนด

ที่ต้องการที่จำเป็นและเงื่อนไขที่เกี่ยวข้องอื่น ๆ ของบทบัญญัติข้อกำหนด 2014/53/UE เนื้อหาที่สมบูรณ์ของประกาศความสอดคล้องกับ EU มีอยู่ที่ <https://www.asus.com/support/>

การทำงานของ WiFi ที่ 5150-5350MHz ถูกจำกัดให้ใช้ในอาคารสำหรับประเทศที่แสดงในตาราง

Basitleştirilmiş AB Uyumluluk Bildirimi

ASUSTek Computer Inc., bu aygıtın 2014/53/UE Yönergesinin temel gereksinimlerine ve diğer ilgili hükümlerine uygun olduğunu bildirir. AB uyumluluk bildiriminin tam metni şu adreste bulunmaktadır: <https://www.asus.com/support/>

5150-5350 MHz aralındaki WiFi çalışması, tabloda listelenen ülkeler için iç mekan kullanımıyla kısıtlanacaktır.

Спрощена декларація про відповідність нормам ЄС

ASUSTek Computer Inc. заявляє, що цей пристрій відповідає основним вимогам та іншим відповідним вимогам Директиви 2014 / 53 / EU. Повний текст декларації відповідності нормам ЄС доступний на <https://www.asus.com/support/>

Робота Wi-Fi на частоті 5150-5350 МГц обмежується використанням у приміщенні для країн, поданих у таблиці нижче:



AT	BE	BG	CZ	DK	EE	FR
DE	IS	IE	IT	EL	ES	CY
LV	LI	LT	LU	HU	MT	NL
NO	PL	PT	RO	SI	SK	TR
FI	SE	CH	UK	HR		

Intel® Wi-Fi 6 AX200 output power table:

Function	Frequency	Maximum Output Power (EIRP)
WiFi	2400 - 2483.5 MHz	18.2 dBm
	5150 - 5350 MHz	19.3 dBm
	5470 - 5725 MHz	19.27 dBm
Bluetooth	5725 - 5850 MHz	10.87 dBm
	2400 - 2483.5 MHz	10.66 dBm

For the standard EN 300 440, if this device operates in 5725-5875 MHz, it will be considered as a receiver category 2.

ASUS Wi-Fi Card
Contains Wi-Fi 6 module with Bluetooth 5.1
Model: AX200NGW
IF/ETEL: RCPINAX190-0480
FCC ID: PDBAX200NG
CAN ID: 2019A22274M
IC: 1000A-AX200NG
Jordan: TRC/SS/2019/122
KABTEL: PABTEL/ANTEL/MARTEL
Product registered: 18F-0000-0000-2019
Date Registered: 2/20/2019

Complies with
IMDA Standards
DB02941

FC
R&MZ

ASUS contact information

ASUSTeK COMPUTER INC.

Address 1F., No. 15, Lide Rd., Beitou Dist., Taipei City 112, Taiwan
Telephone +886-2-2894-3447
Fax +886-2-2890-7798
Web site <https://www.asus.com>

Technical Support

Telephone +86-21-38429911
Online support <https://qr.asus.com/techserv>

ASUS COMPUTER INTERNATIONAL (America)

Address 48720 Kato Rd., Fremont, CA 94538, USA
Telephone +1-510-739-3777
Fax +1-510-608-4555
Web site <https://www.asus.com/us/>

Technical Support

Support fax +1-812-284-0883
Telephone +1-812-282-2787
Online support <https://qr.asus.com/techserv>

ASUS COMPUTER GmbH (Germany and Austria)

Address Harkortstrasse 21-23, 40880 Ratingen, Germany
Web site <https://www.asus.com/de>
Online contact <https://www.asus.com/support/Product/ContactUs/Services/questionform/?lang=de-de>

Technical Support

Telephone (DE) +49-2102-5789557
Telephone (AT) +43-1360-2775461
Online support <https://www.asus.com/de/support>