



RAZER BLACKSHARK V2

MASTER GUIDE

If esports is everything, give it your all with the **Razer BlackShark V2**.
Introducing a triple threat of amazing audio, superior mic clarity, and
supreme sound isolation. Fitted with titanium-coated drivers, a USB sound
card, softer ear cushions and THX Spatial Audio, your time to turn pro is
now.

CONTENTS

| | |
|--|----|
| 1. WHAT'S INSIDE / WHAT'S NEEDED | 3 |
| 2. LET'S GET YOU COVERED | 5 |
| 3. TECHNICAL SPECIFICATIONS | 6 |
| 4. CONNECTING THE HEADSET | 7 |
| 5. USING THE RAZER BLACKSHARK V2 | 9 |
| 6. CONFIGURING YOUR RAZER USB SOUND CARD | 12 |
| 7. SAFETY AND MAINTENANCE | 26 |
| 8. LEGALESE | 27 |

1. WHAT'S INSIDE / WHAT'S NEEDED

WHAT'S INSIDE

- Razer BlackShark V2

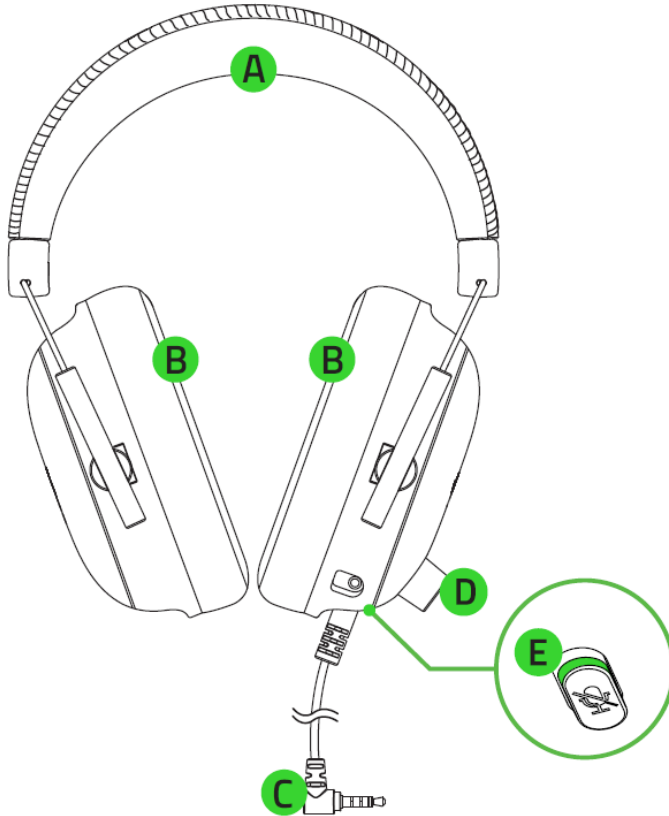

- A. Adjustable padded headband
- B. Ultra-soft memory foam ear cushions
- C. 3.5 mm audio + mic jack
- D. Volume control knob
- E. Mic mute button

- Removable Razer™ HyperClear cardioid mic

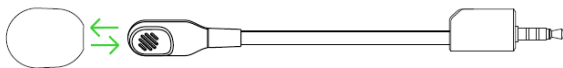

- USB sound card

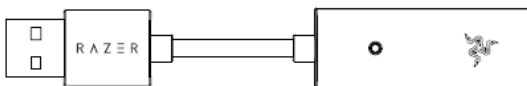

- Important Product Information Guide

WHAT'S NEEDED

PRODUCT REQUIREMENTS

- Devices with a free USB port
- Devices with 3.5 mm audio + mic combined jack*

RAZER SYNAPSE REQUIREMENTS

- Windows® 10 64-bit (or higher)
- Internet connection for software installation

**Compatible with PC / Mac / Switch / PS4 / Xbox One (Xbox One Stereo Adapter may be required, purchased separately).*

2. LET'S GET YOU COVERED

You've got a great device in your hands, complete with a 2-year limited warranty coverage. Now maximize its potential and score exclusive Razer benefits by registering at razerid.razer.com

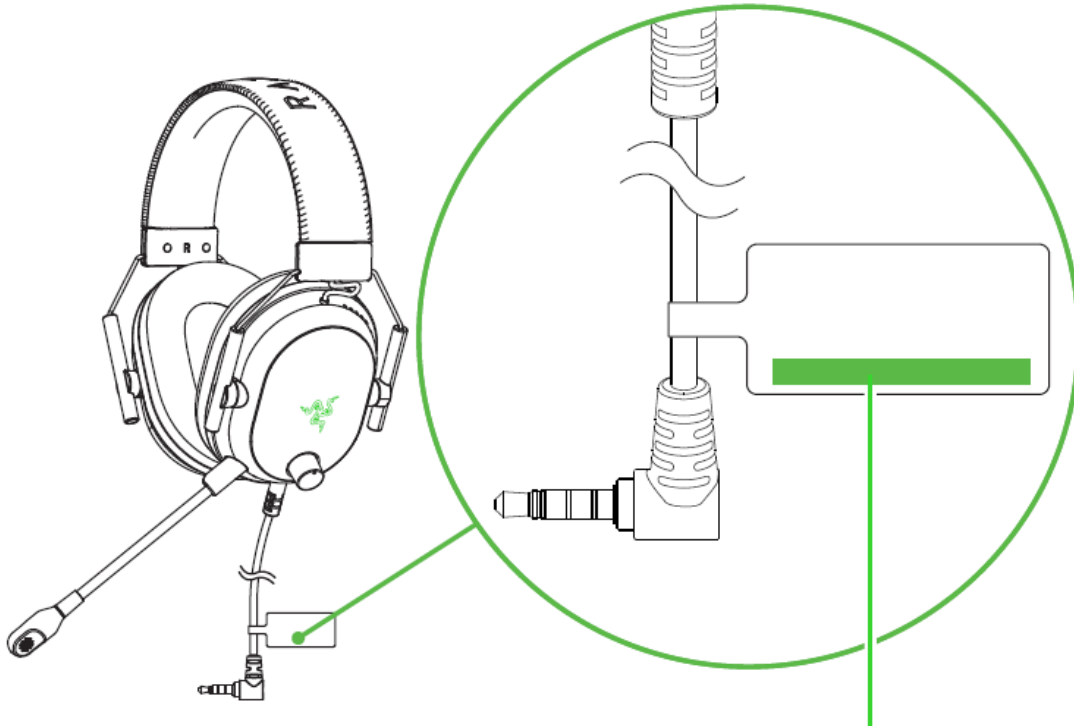

Your product's serial number can be found here.

Got a question? Ask the Razer Support Team at support.razer.com

3. TECHNICAL SPECIFICATIONS

HEADPHONES

- Frequency response: 12 Hz - 28 KHz
- Impedance: 32 Ω @ 1 KHz
- Sensitivity (@1kHz): 100 dB SPL / mW,1KHz
- Drivers: Customized Dynamic 50 mm Driver
- Inner ear cup diameter: 65 mm x 40 mm / 2.56 in x 1.57 in
- Connection type: 3.5 mm with USB sound card
- Cable length: 1.8 m / 5.91 ft
- Approx. weight: 262 g / 0.6 lbs
- Oval ear cushions: Breathable memory foam cushions

MICROPHONE

- Frequency response: 100Hz - 10KHz
- Signal-to-noise ratio: 60 dB
- Sensitivity (@1kHz) -42 dB V/Pa,1KHz
- Pick-up pattern: Unidirectional
- Mute Function: Click-to-mute

4. CONNECTING THE HEADSET

TO YOUR PC VIA USB PORT

1. Plug your headset to the USB Sound Card, and then to your PC.

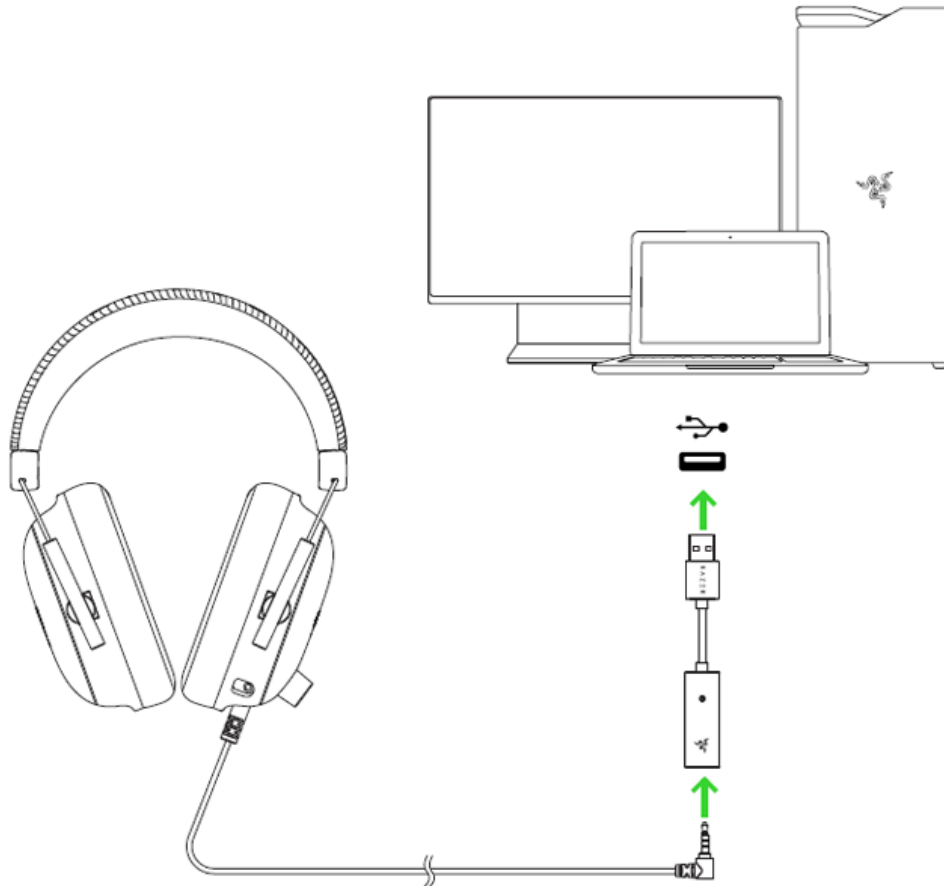

2. On your PC, right-click on the sound icon on the system tray, and then select **Open Sound settings**.

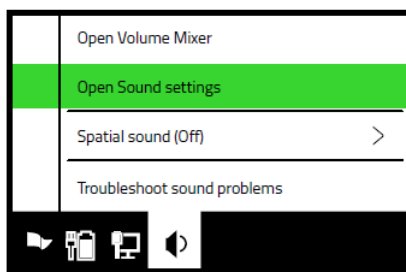

3. On the **Sounds** window, set Razer USB Sound Card as the default **Output** and **Input** device.

Sounds

Output

Choose your output device

Razer USB Sound Card



Input

Choose your input device

Razer USB Sound Card

TO OTHER DEVICES VIA USB PORT

Plug your Razer BlackShark V2 to the Razer USB Sound Card*, and then to your device. Make sure the Razer USB Sound Card is set as the default input and output device.

**Compatible with PC / Mac / Switch / PS4.*

TO DEVICES VIA 3.5MM COMBO PORT

If your device has a 3.5mm audio + mic combined port, simply plug the 3.5mm audio + mic connector from your headset to your device's audio port.

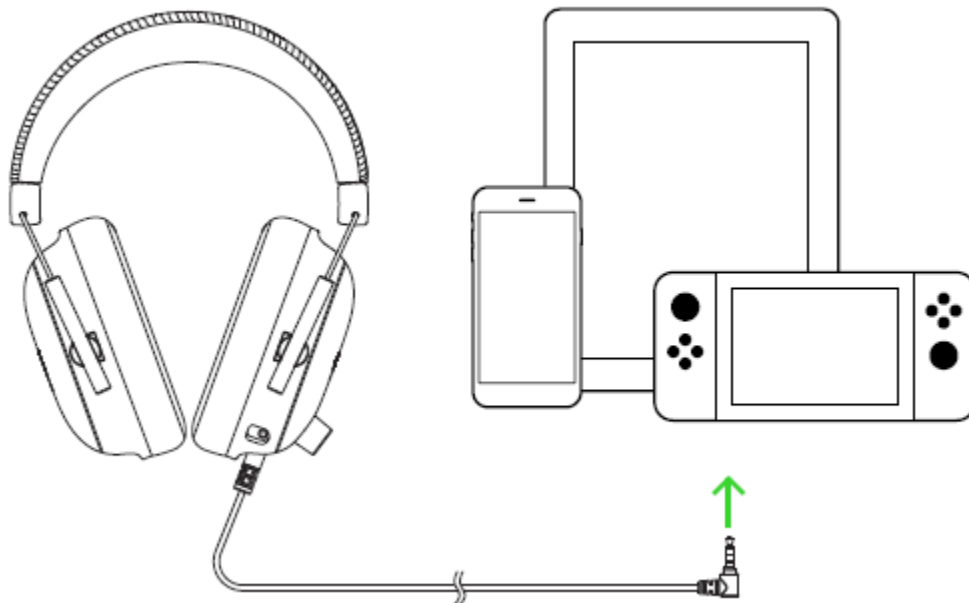

5. USING THE RAZER BLACKSHARK V2

USING THE MICROPHONE

Plug the Razer™HyperClear Cardioid Mic to the headphone, then bend until it is parallel to your mouth. Make sure the mic diaphragm is in front and the air vent is facing away from your mouth.

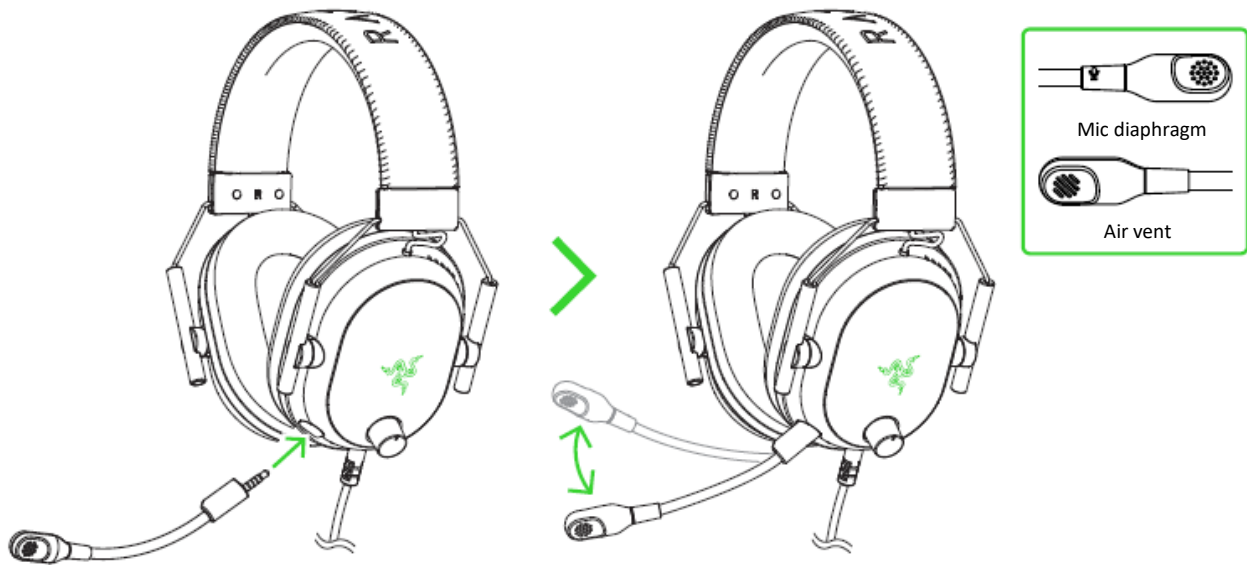

MUTING / UNMUTING THE MICROPHONE

Press the mic mute button to mute or unmute the microphone.

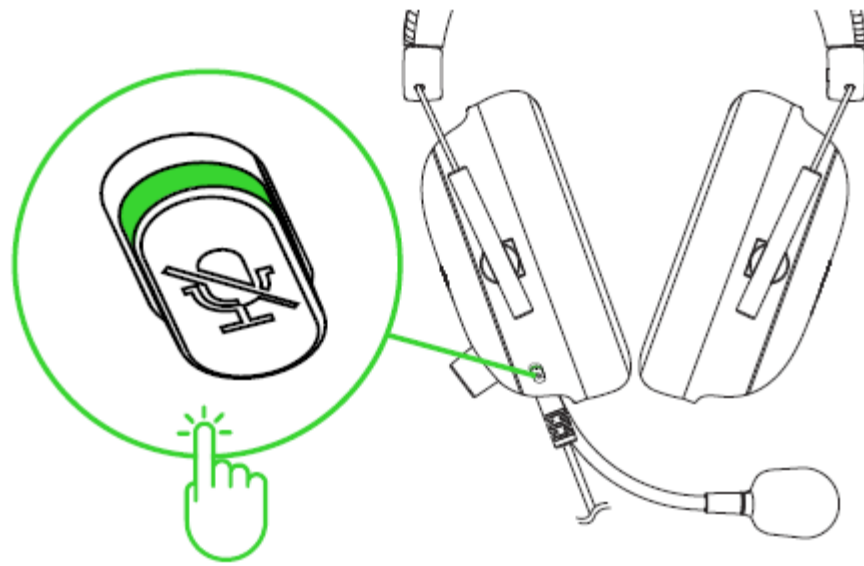

ADJUSTING THE VOLUME

Rotate the volume control knob as shown below to increase or decrease the volume.

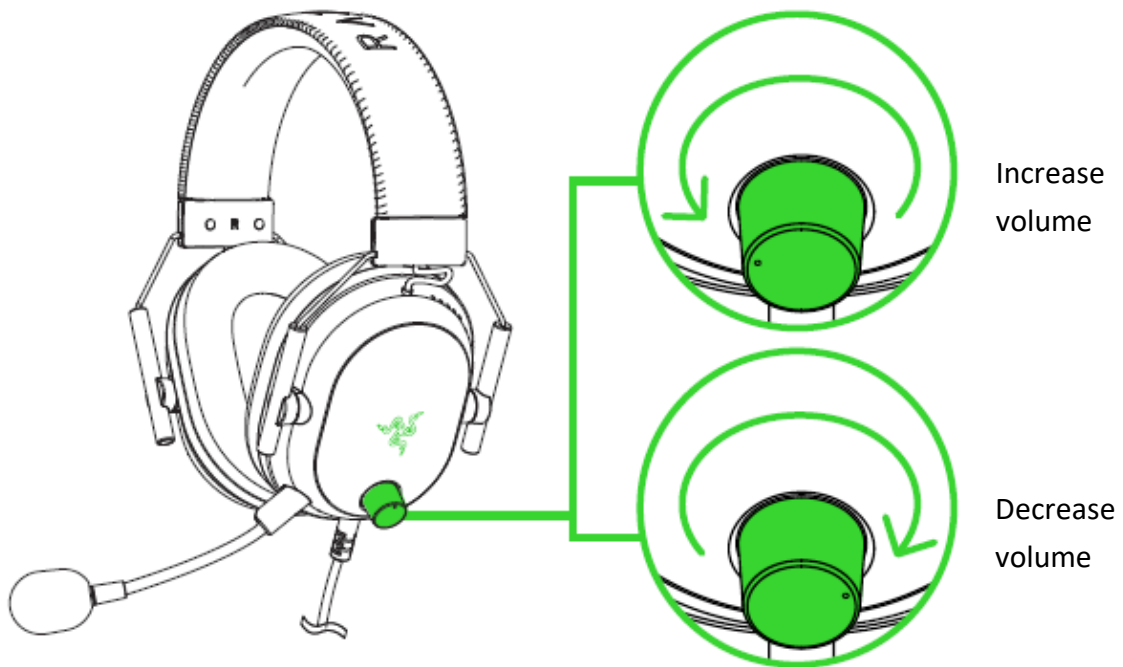

EXTENDING YOUR HEADSET'S LIFESPAN

We recommend stretching the headset gently apart before placing them over your head to minimize headband stress. However, please avoid overstretching the headset beyond its technical limits.

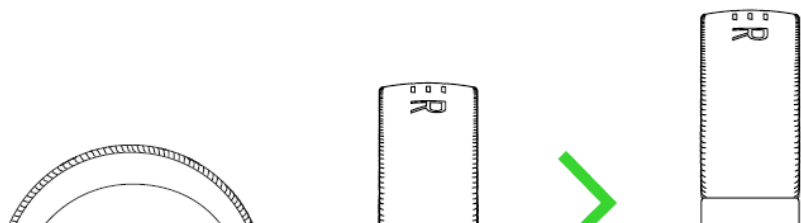

ACTIVATE THX SPATIAL AUDIO

Unleash the full potential of your Razer BlackShark V2 by enabling 360° positional audio for a natural and lifelike experience through Razer Synapse.



6. CONFIGURING YOUR RAZER USB SOUND CARD

i *Internet connection is required for installation, updates and cloud-based features. Registering for a Razer ID account is recommended, but optional. All listed features are subject to change based on the current software version, connected device(s), and supported apps and software.*

SYNAPSE TAB

The Synapse tab is your default tab when you first launch Razer Synapse. This tab allows you to navigate the Dashboard subtab.

Dashboard

The Dashboard subtab is an overview of your Razer Synapse where you can access all your Razer devices, modules, and online services.

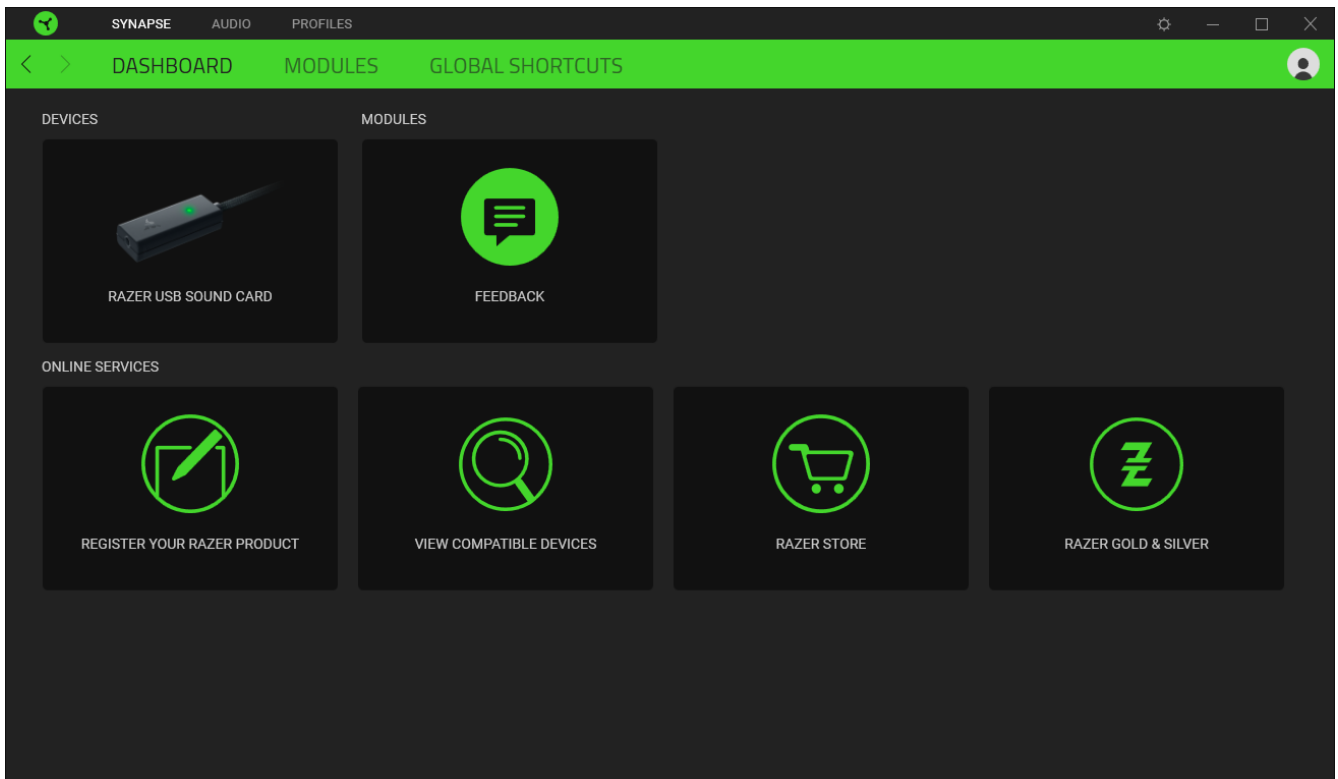

Modules

The Modules subtab displays all installed and available modules for installation.

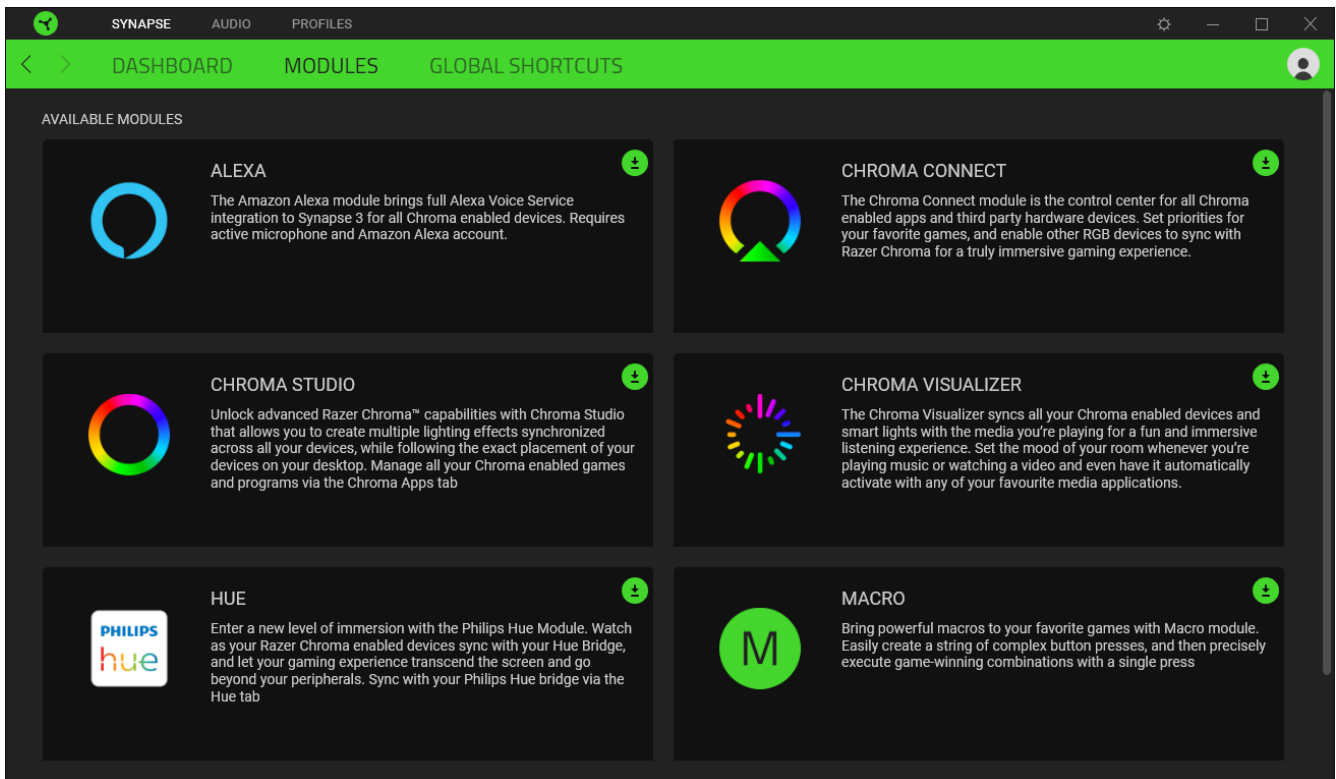

Global Shortcuts

Bind operations or Razer Synapse functions to custom key-combinations from any Razer Synapse-enabled device inputs which apply across all device profiles. [Learn more about Profiles](#)

 *Only Razer Synapse-enabled device inputs will be recognized.*

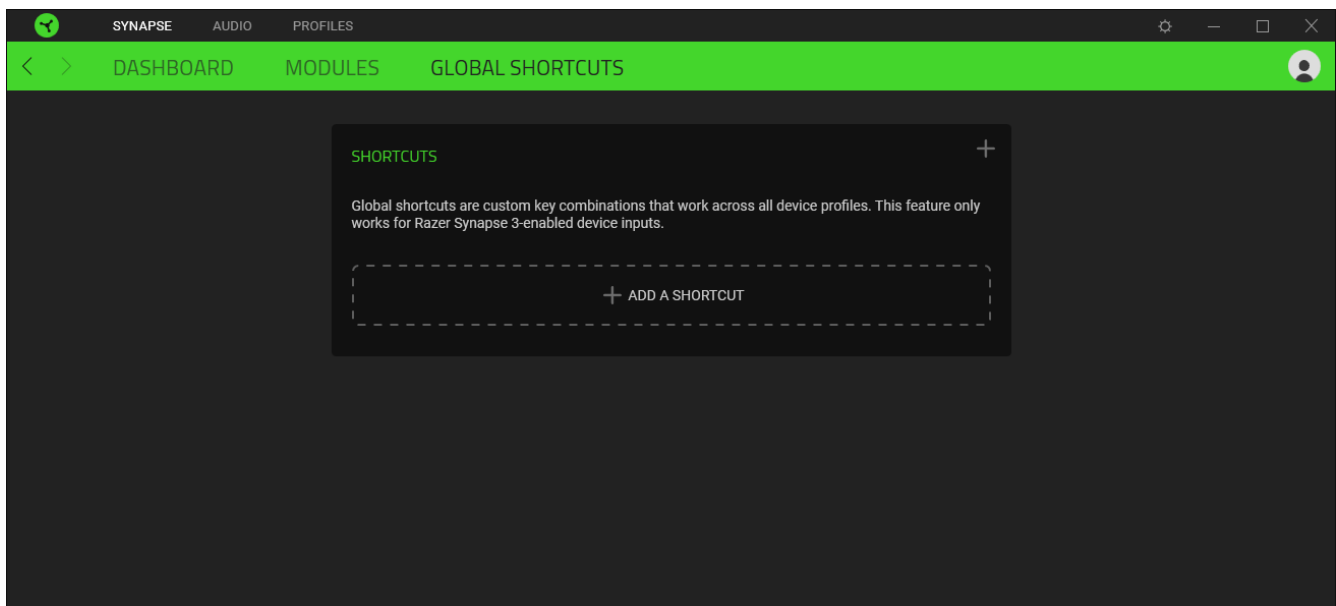

AUDIO TAB



Make sure to select THX Spatial Audio as your default playback or output device from the Sound icon on the system tray.

The Audio tab is the main tab for your Razer USB Sound Card. From here, you can customize your device's settings to unleash its full potential. Changes made under this tab are automatically saved to your system and cloud storage.

SOUND

The Sound subtab is for adjusting the overall system volume or individual volume of all active applications, changing the default fallback device, and accessing Windows Sound properties.

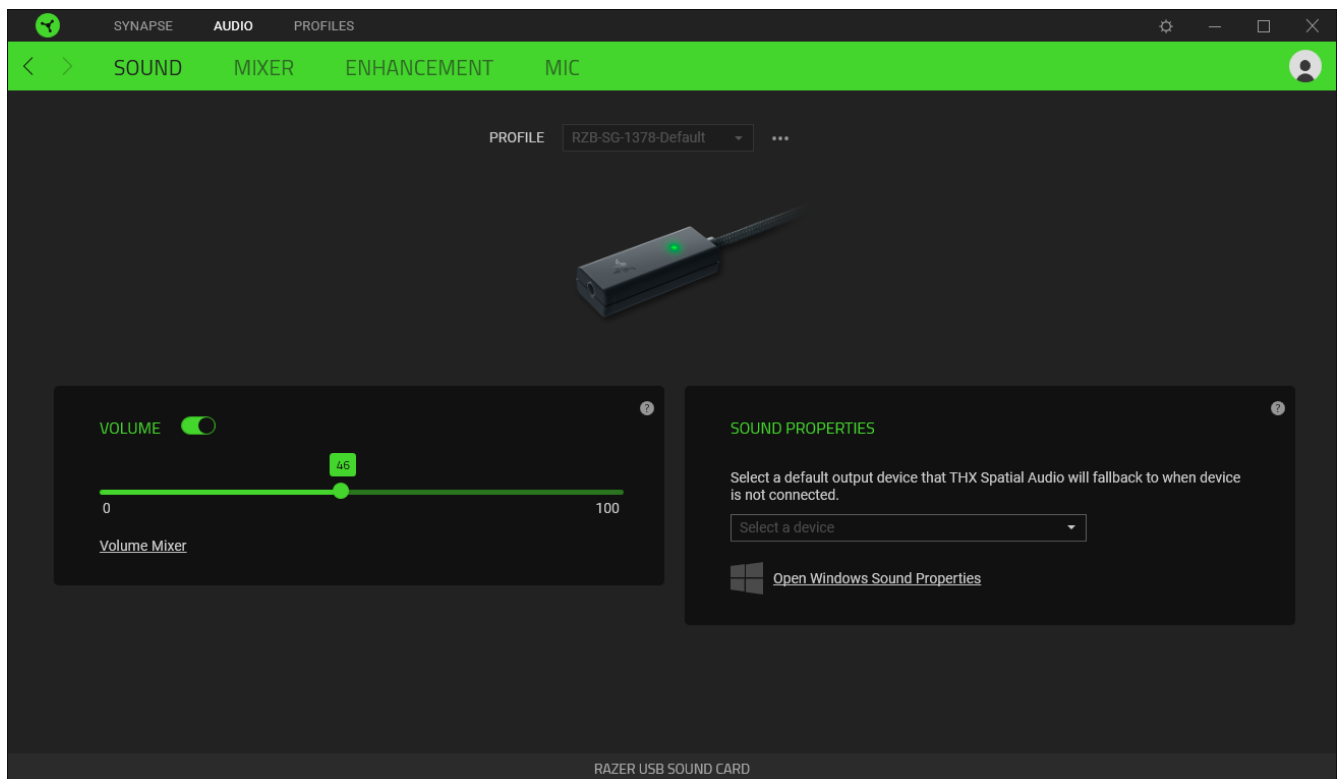

Profile

Profile is a data storage for keeping all your Razer peripheral's settings. By default, the profile name is based on your system's name. To add, rename, duplicate, or delete a profile, simply press the Miscellaneous button (●●●).

Volume

Adjust the audio volume of the device. You may also access the Windows volume mixer of the current playback device where you can proportionally adjust the overall volume of the system or individually adjust the volume of each active application.

Sound Properties

Set a default output device that the THX Spatial Audio will use when the Razer USB Sound Card is not connected. You may also click on the Windows Sound Properties link to manage the sound settings of your system such as modifying the playback and recording device settings, sound scheme and default communications activity.

MIXER

The Mixer subtab allows you to enable or disable the THX Spatial Audio and its settings, as well as calibrate the audio positioning of all virtual speakers of the active spatial audio mode.

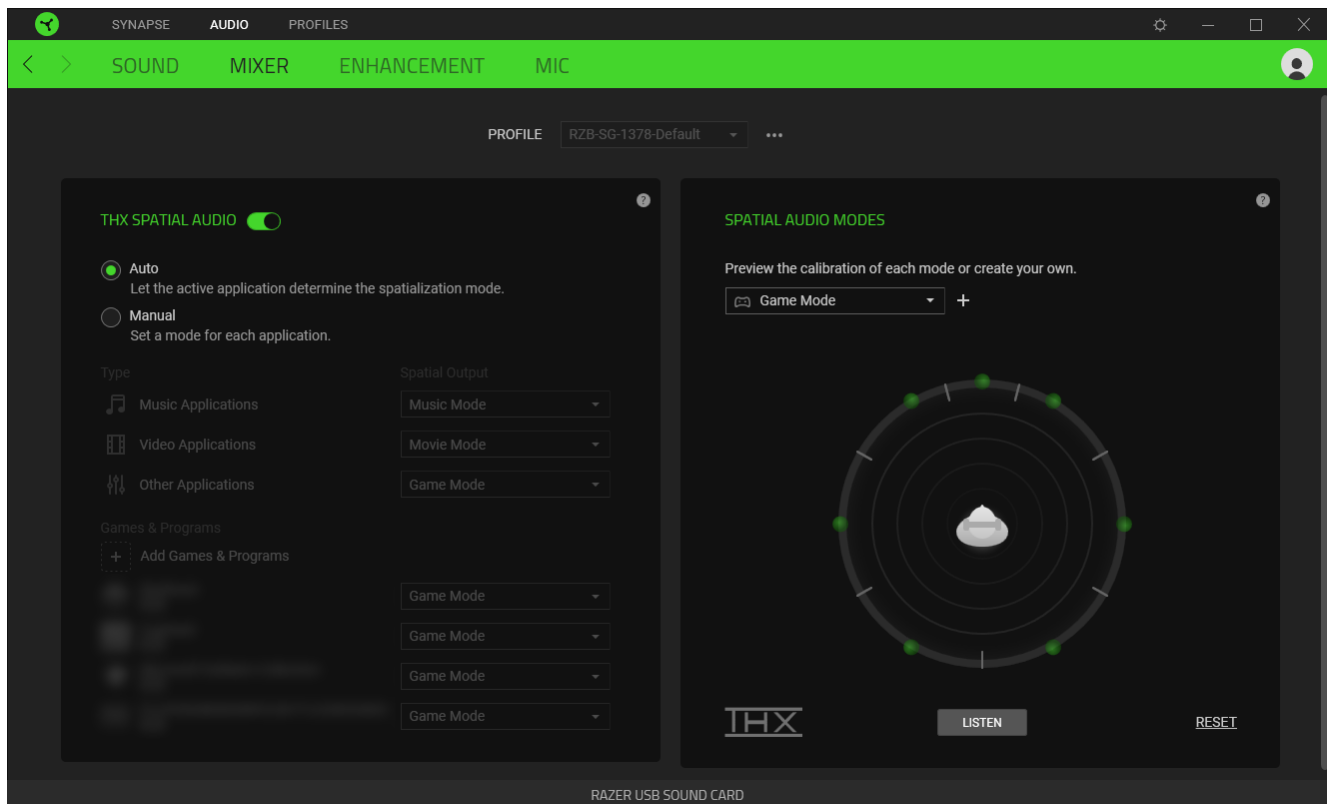

THX Spatial Audio

THX Spatial Audio technology is an advanced positional audio solution that delivers a heightened, immersive experience as you game.

Toggle this setting to enable or disable THX Spatial Audio and its settings. By default, this is set to Auto where all applications will use the recommended output setting. Using Manual will allow you to assign preferred spatial audio modes to specific application types and/or applications.

Spatial Audio Modes

Preview the calibration of each available spatial audio mode preset using the Listen button. Changing the position of any virtual speaker (in any preset mode) will automatically create a Custom Mode. Alternatively, you may also click on the Add button (+) to create a new Custom Mode.

On any Custom Mode, click on the miscellaneous button (●●●) to rename, duplicate, or delete the selected custom mode. To revert the current mode to its original settings, click on the Reset button.

ENHANCEMENT

The Enhancement subtab is for customizing the incoming audio settings and frequency response of your audio system.

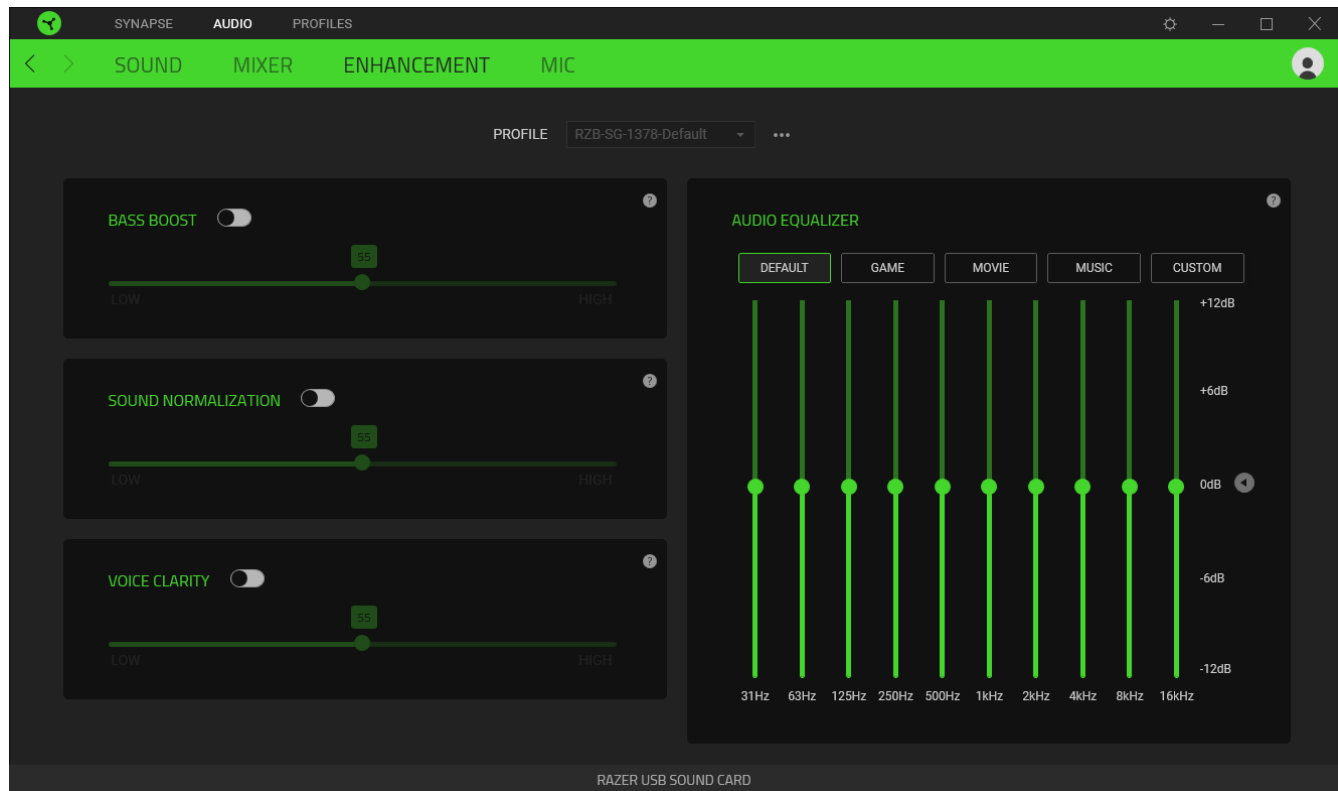

Bass Boost

Enhances the low frequency response to improve the bass output of your headset.

Sound Normalization

Reduces the loudest audio received to avoid sudden and unpleasant increase in volume from effects such as shouting or explosions.

Voice Clarity

Improves the quality of incoming voice conversations by filtering the sound to improve clarity and adjusts the volume.

Audio Equalizer

Select any of the available equalizer presets created for the best audio experience designed for balance, gaming immersion, movie viewing, or enjoying your favorite music. Manually adjusting any equalizer preset will automatically set it to Custom.

MIC

The Mic subtab enables you to change the settings for all outgoing mic audio.

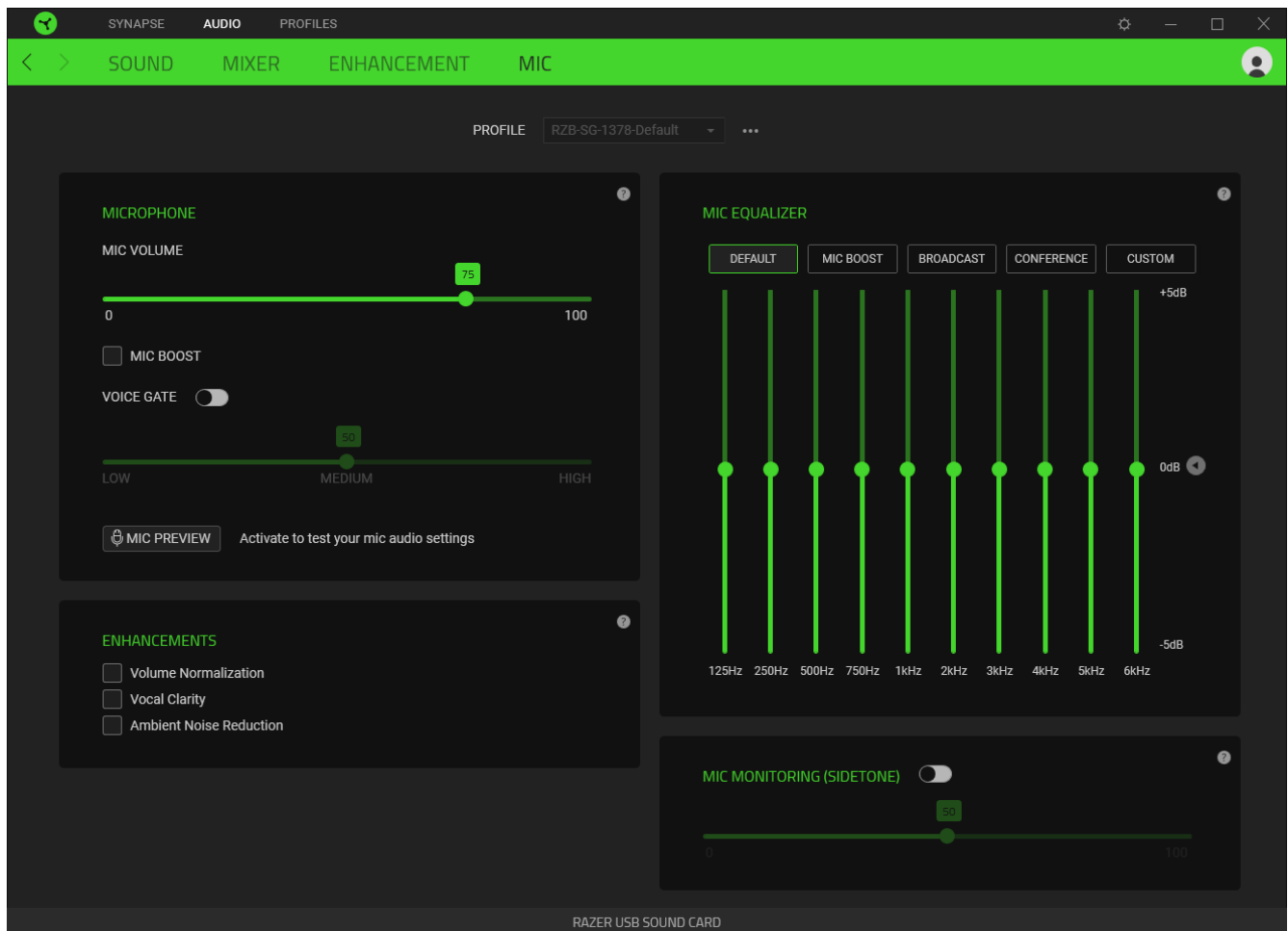

Microphone

Control the mic volume and amount of mic input for a clearer mic audio.

Mic Volume

Adjust the microphone input or mute the mic.

Mic Boost

Enable this feature to further amplify the mic volume.

Voice Gate

Control the amount of mic input so that it cuts out background noises and isolates your voice. Any sound that registers below the threshold will be muted.

Enhancements

Improve the quality of the microphone by enabling any of the listed features below:

- Volume Normalization. Reduces the variation of loudness.
- Ambient Noise Reduction. Decreases environmental noise.
- Vocal Clarity. Emphasizes the voice frequency.

Mic Equalizer

Select any of the available mic equalizer presets which best fits your mic needs. Manually adjusting any equalizer preset will automatically set it as a Custom preset.

Mic Monitoring (Sidetone)

Enable this setting to monitor the microphone's raw audio input through the headset with an additional option to increase or decrease the audio monitoring volume.

PROFILES TAB

The Profiles tab is a convenient way of managing all your profiles and linking them to your games and applications.

Devices

View which games are linked to each device's profiles or which Chroma Effect is linked to specific games using the Devices subtab.

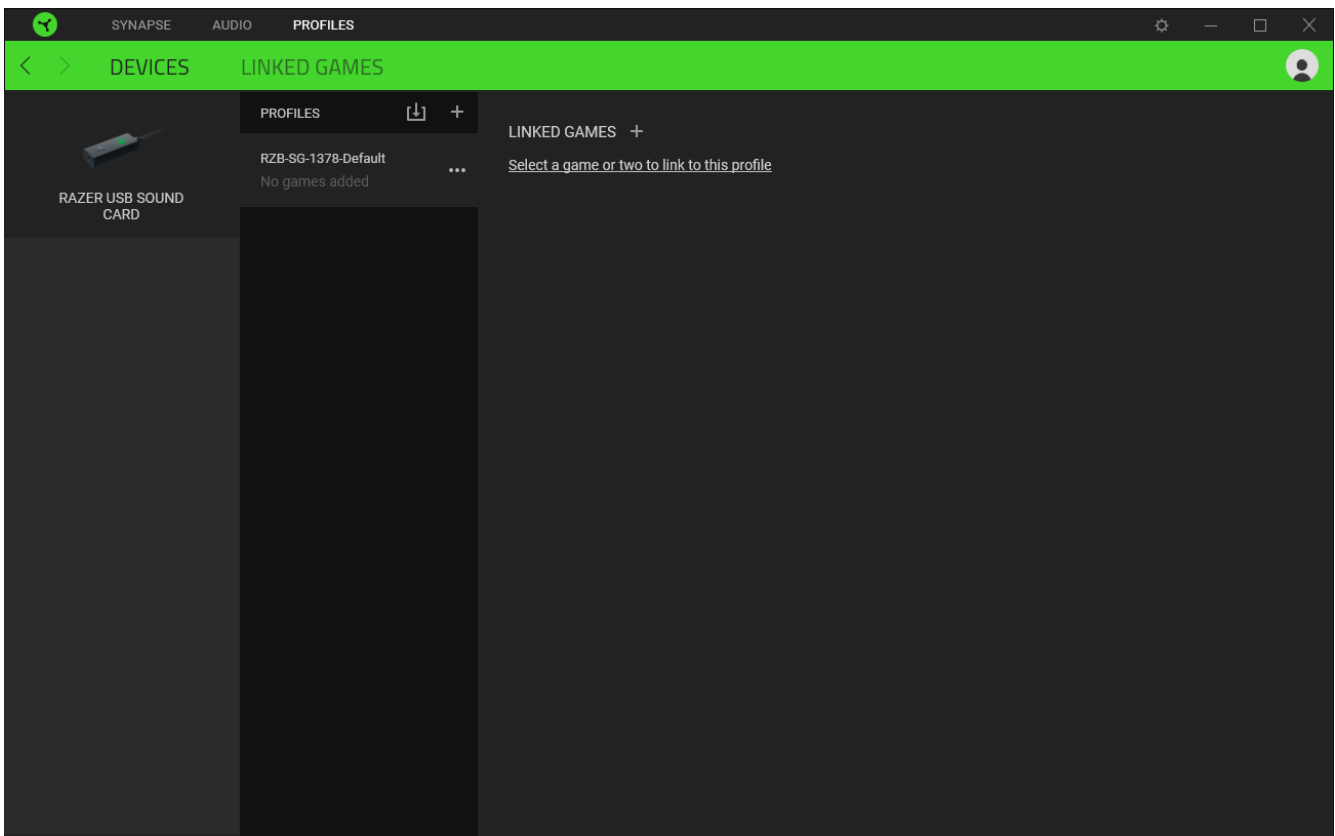

You can import Profiles from your computer or from the cloud through the import button (⏴) or create new profiles within the selected device using the add button (+). To rename, duplicate, export, or delete a profile, simply press the Miscellaneous button (⋮). Each profile can be set to automatically activate when you run an application using the Linked Games option.

Linked Games

The Linked Games subtab gives you the flexibility to add games, view devices that are linked to games, or search for added games. You can also sort games based on alphabetical order, last played, or most played. Added games will still be listed here even if it is not linked to a Razer device.

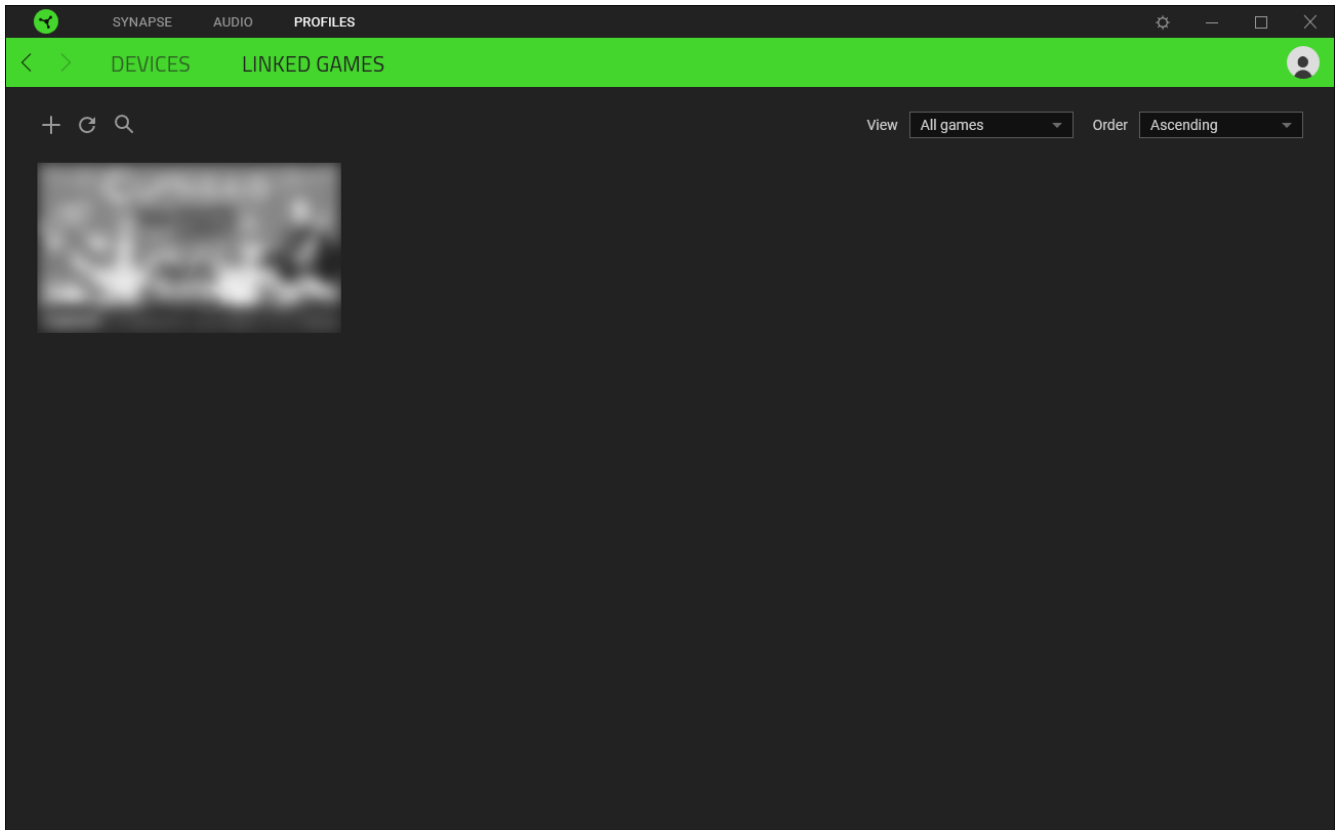

To link games to connected Razer devices or Chroma Effects, simply click on any game from the list, and then click **Select a device and its profile to launch automatically during gameplay** to select the Razer device or Chroma Effect it will link with. Once linked, you may click on the Miscellaneous button (●●●) of the corresponding Chroma Effect or device to select a specific Chroma Effect or profile.

SETTINGS WINDOW

The Settings window, accessible by clicking the (⚙) button on Razer Synapse, enables you to configure the start-up behavior and display language of Razer Synapse, view the master guides of each connected Razer device, or perform factory reset on any connected Razer device.

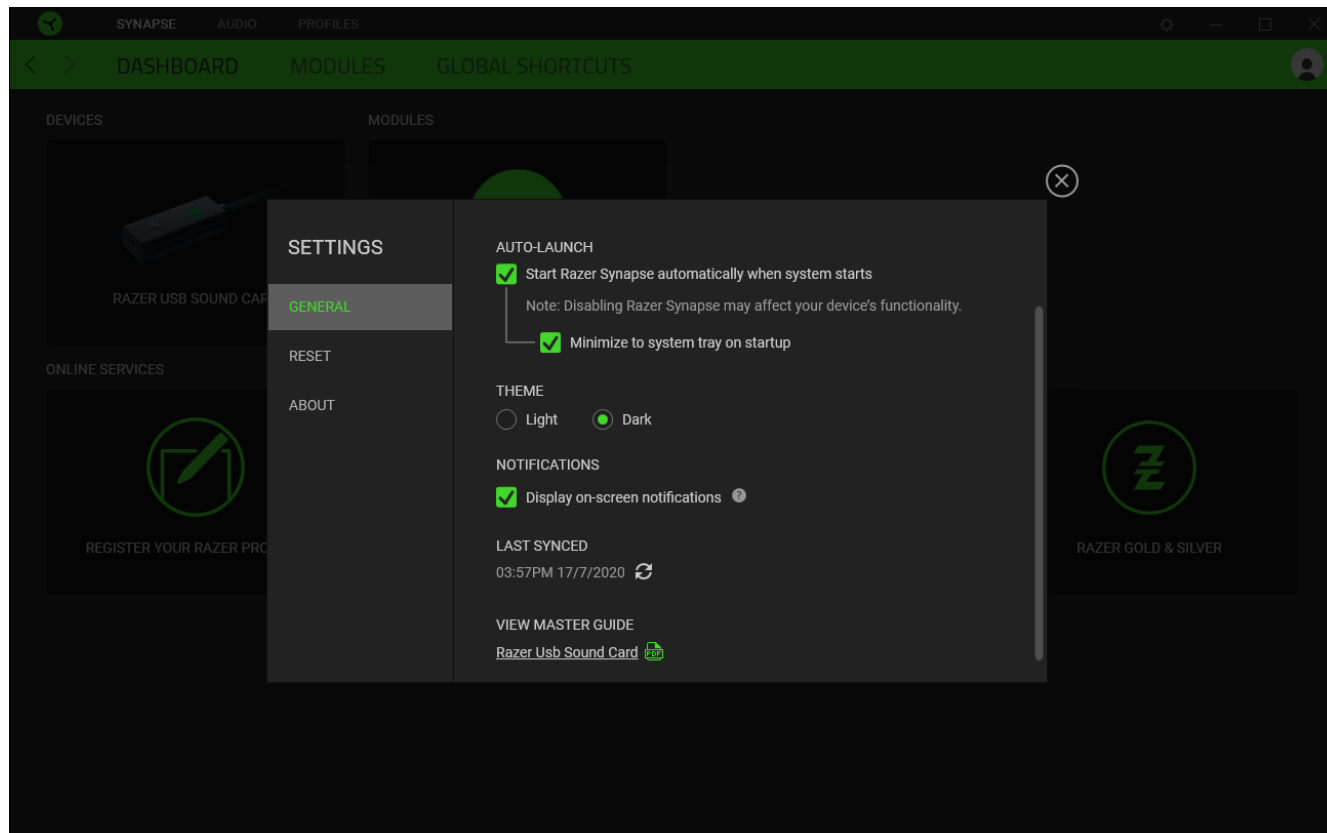

General tab

The default tab of the Settings window. The General tab enables you to change the software's display language, start-up behavior, display theme, and on-screen notifications display. You may also manually sync your profiles to the cloud (↻) or view the master guide of all connected Razer devices and installed modules.

Reset tab

The Reset tab allows you to perform a factory reset on all connected Razer devices with on-board memory and/or reset Razer Synapse tutorials to acquaint yourself again with Razer Synapse's new features on its next launch.



By resetting a Razer device, all profiles stored on the selected device's on-board memory will be erased.

About tab

The About tab displays brief software information, copyright statement and provides relevant links for its terms of use. You may also use this tab to check for software updates, or as a quick access to Razer's social communities.

7. SAFETY AND MAINTENANCE

SAFETY GUIDELINES

In order to achieve maximum safety while using your Razer BlackShark V2, we suggest that you adopt the following guidelines:

Should you have trouble operating the device properly and troubleshooting does not work, unplug the device and contact the Razer hotline or go to support.razer.com for assistance.

Do not take apart the device and do not attempt to operate it under abnormal current loads. Doing so may void your warranty.

Keep the device away from liquid, humidity or moisture. Operate the device only within the specific temperature range of 0°C (32°F) to 40°C (104°F). Should the temperature exceed this range, unplug and/or switch off the device in order to let the temperature stabilize to an optimal level.

The device isolates external ambient sounds even at low volumes, resulting in lowered awareness of your external surroundings. Please remove the device when engaging in any activities that requires active awareness of your surroundings.

Listening to excessively loud volumes over extended periods of time can damage your hearing. Furthermore, legislation of certain countries permits a maximum sound level of 86db to affect your hearing for 8 hours a day. We therefore recommend that you reduce the volume to a comfortable level when listening for prolonged periods of time. Please, take good care of your hearing.

MAINTENANCE AND USE

The Razer BlackShark V2 requires minimum maintenance to keep it in optimum condition. Once a month we recommend you unplug the device and its accessory (if applicable) from the computer and clean each component using a soft cloth or cotton swab to prevent dirt buildup. Do not use soap or harsh cleaning agents.

8. LEGALESE

COPYRIGHT AND INTELLECTUAL PROPERTY INFORMATION

©2020 Razer Inc. All rights reserved. Razer, the triple-headed snake logo, Razer logo, “For Gamers. By Gamers.”, and “Powered by Razer Chroma” logo are trademarks or registered trademarks of Razer Inc. and/or affiliated companies in the United States or other countries. All other trademarks are the property of their respective owners.

THX and the THX logo are trademarks of THX Ltd., registered in the U.S. and other countries.

Windows and the Windows logo are trademarks or registered trademarks of the Microsoft group of companies.

Razer Inc. (“Razer”) may have copyright, trademarks, trade secrets, patents, patent applications, or other intellectual property rights (whether registered or unregistered) concerning the product in this guide. Furnishing of this guide does not give you a license to any such copyright, trademark, patent or other intellectual property right. The Razer BlackShark V2 (the “Product”) may differ from pictures whether on packaging or otherwise. Razer assumes no responsibility for such differences or for any errors that may appear. Information contained herein is subject to change without notice.

LIMITED PRODUCT WARRANTY

For the latest and current terms of the Limited Product Warranty, please visit [razer.com/warranty](https://www.razer.com/warranty).

LIMITATION OF LIABILITY

Razer shall in no event be liable for any lost profits, loss of information or data, special, incidental, indirect, punitive or consequential or incidental damages, arising in any way out of distribution of, sale of, resale of, use of, or inability to use the Product. In no event shall Razer’s liability exceed the retail purchase price of the Product.

GENERAL

These terms shall be governed by and construed under the laws of the jurisdiction in which the Product was purchased. If any term herein is held to be invalid or unenforceable, then such term (in so far as it is invalid or unenforceable) shall be given no effect and deemed to be excluded without invalidating any of the remaining terms. Razer reserves the right to amend any term at any time without notice.