



JLAB AUDIO  
BLUETOOTH®  
EARBUDS

We love that you are rocking JLab Audio!  
We take pride in our products and fully stand behind them.



**YOUR SATISFACTION IS GUARANTEED**

You may exchange or return merchandise within 30 days of the purchase date. Please return the item to the location you purchased it. If your item has been opened or used, restrictions may apply.



**YOUR WARRANTY**

You may register your product at [jlabaudio.com/register](http://jlabaudio.com/register). All warranty claims are subject to JLab Audio authorization and at our sole discretion. Retain your proof of purchase to ensure warranty coverage.



**CONTACT US**

Reach out to us at [support@jlabaudio.com](mailto:support@jlabaudio.com) or visit [jlabaudio.com/contact](http://jlabaudio.com/contact).

**FIRST TIME SETUP: BLUETOOTH PAIRING**

**1** Turn on the Bluetooth in your device settings.

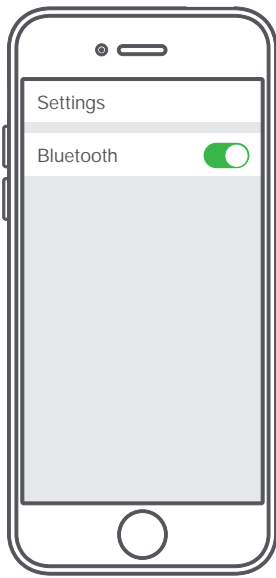

**2**

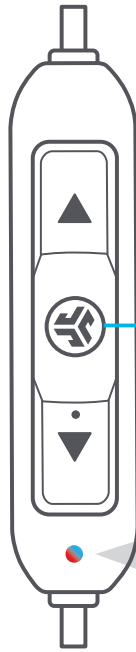

Press and hold button for **10 seconds**.  
Release.  
Light will **blink red and blue** to indicate pairing mode.



**3** Select "JLab BT" in your device settings to connect.

Light will **slow blink blue** when Bluetooth is paired.

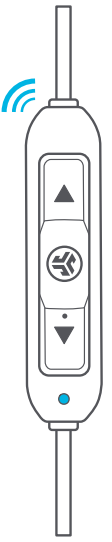
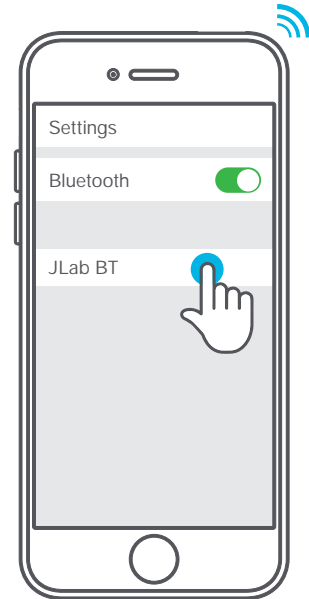

**RECURRING USE**

Once JLab BT has initially paired to your device, the earbuds will auto-connect to your Bluetooth device when powered back ON. (Follow **BUTTON FUNCTIONS** instructions)

**ACCESSORIES**



VARIOUS TIP & CUSH FIN™ SIZES  
(STYLES AND OPTIONS VARY BY PRODUCT)



SHIRT CABLE CLIP



MICRO USB CABLE

## BUTTON FUNCTIONS

- VOLUME UP:** Click once.
- TRACK FORWARD:** Click & hold 2+ seconds.
- POWER ON:** Click & hold 3 seconds.
- POWER OFF:** Click & hold 5 seconds.
- PLAY / PAUSE:** Click once.
- ANSWER / HANG UP CALLS:** Click once.
- ACTIVATE SIRI (iOS) OR "OK GOOGLE" (ANDROID):** Click twice.
- BLUETOOTH PAIRING:** (Follow First Time Setup: Bluetooth Pairing)
- VOLUME DOWN:** Click once.
- TRACK BACKWARD:** Click & hold 2+ seconds.

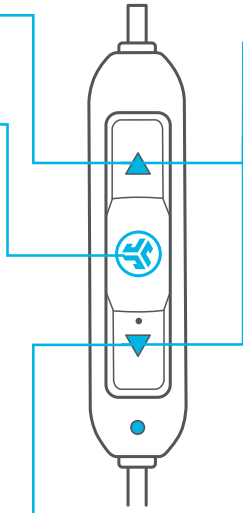

## EQUALIZER MODES

Quick press both buttons for different EQ settings (JLab BT earbuds will cycle 3 EQ settings)

**JLab SIGNATURE (One Beep)**

JLab C3™ signature sound with amplified vocals and bass

**BALANCED (Two Beeps)**

Even sound with no additional sound enhancements

**BASS BOOST (Three Beeps)**

Amplified bass and sub-bass

## VOICE PROMPTS

**"HELLO"**  
Power is ON.

**"READY TO PAIR"**  
JLab BT earbuds are ready to connect to your Bluetooth device.

**"YOU'RE CONNECTED"**  
JLab BT earbuds are connected to your Bluetooth device and ready for use.

**"GOODBYE"**  
Power turning OFF.

## CHARGING

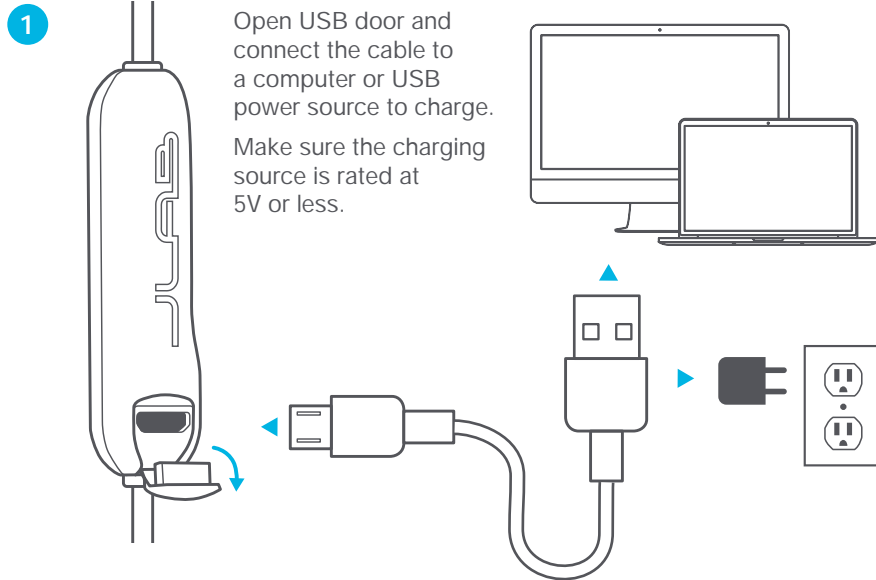

**2** Light will **turn solid red** when charging and **turn blue** when fully charged.

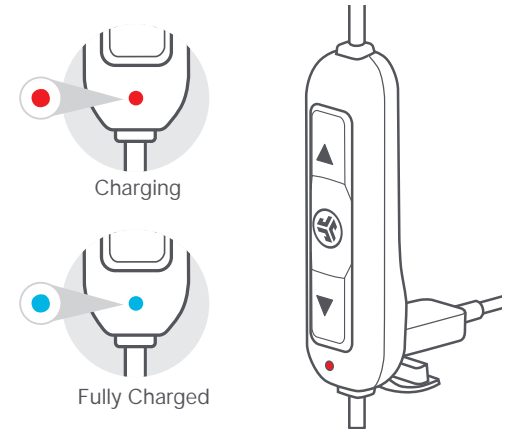

## FITTING

**1** First put on the Cush Fin followed by the gel ear tip.  
**Note: Styles and options may vary.**

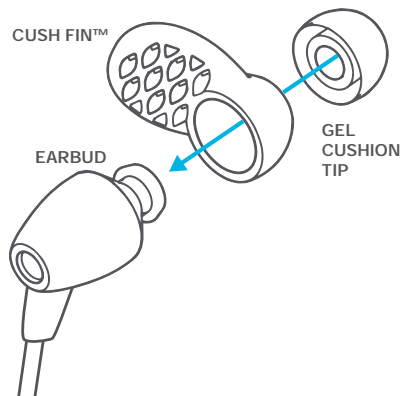

**2** Rotate Cush Fins to desired position.



**3** Try various ear tips and Cush Fins to find best fit.



## CABLE CLIP USE

- 1 Attach the cable clip near the center of the cable.

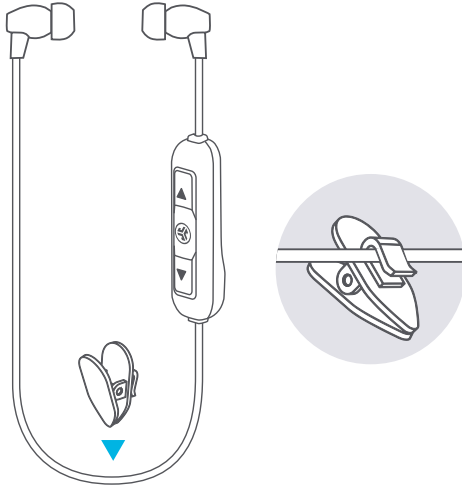

- 2 Clip in the back or front position of shirt.

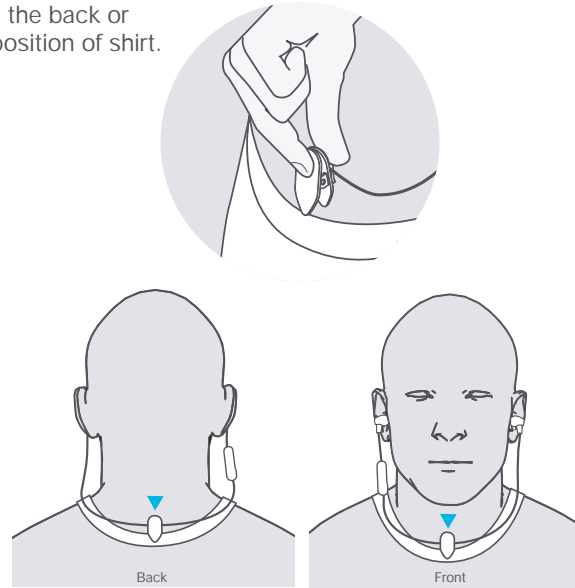

## CONNECTION TROUBLESHOOTING

### I DO NOT SEE JLAB BT IN MY DEVICE

- 1 Turn Bluetooth off and then back on in device settings.

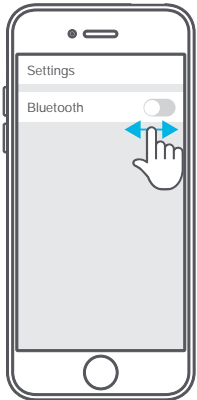

- 2 If you still do not see JLab BT, repeat **FIRST TIME SETUP: BLUETOOTH PAIRING** directions.

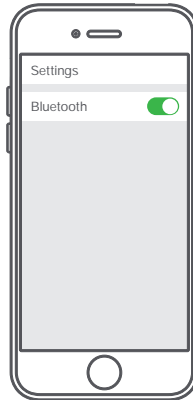

### JLAB BT DOES NOT RECONNECT TO MY DEVICE AFTER POWERING ON

- 1 In device settings, forget the JLab BT.

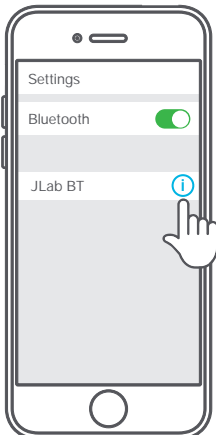

- 2 Turn Bluetooth off then back on in device settings.

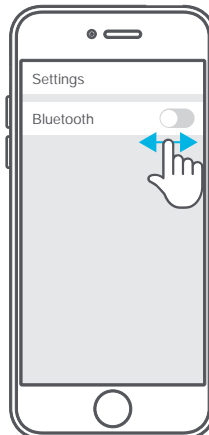

- 3 Repeat **FIRST TIME SETUP: BLUETOOTH PAIRING** directions.

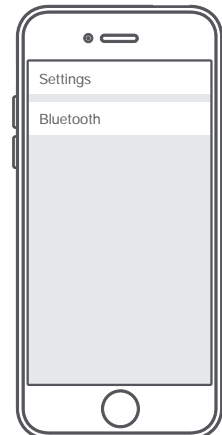

## CONNECTION TROUBLESHOOTING (CONTINUED)

### BLUETOOTH IS CONNECTING TO AN UNWANTED DEVICE

Note: The JLab BT can remember up to 8 devices. It will try to auto-connect to last device used.

- 1 If you have more than one device that was connected to JLab BT, turn OFF Bluetooth on unwanted devices and turn ON Bluetooth on chosen device.

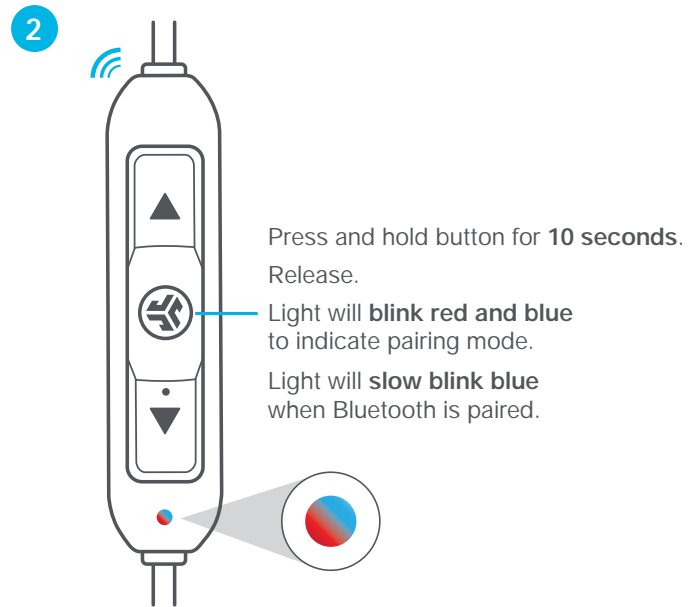
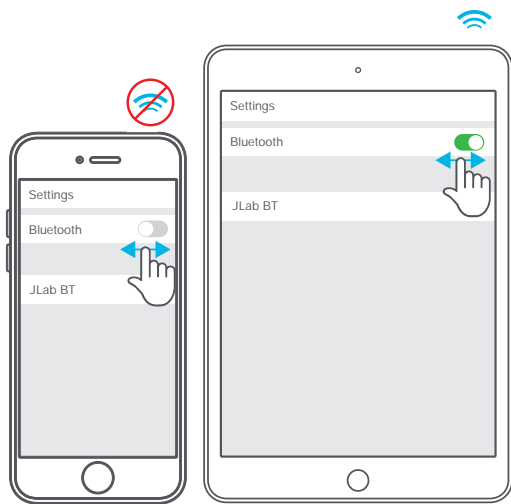

## WARNING

Make sure USB door is closed and fastened.

This will protect against sweat and water damage.

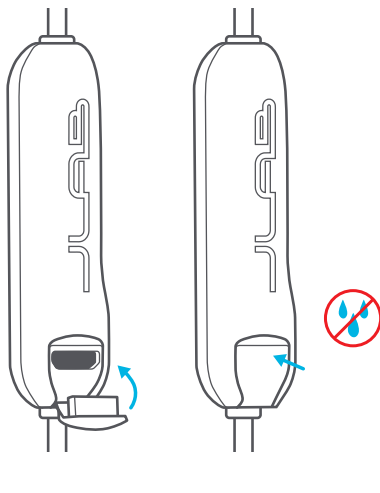

Before charging, the JLab BT earbuds need to be fully dry.

If there is any exposure to moisture, the internal components may become damaged.

It is best practice to air dry before charging.

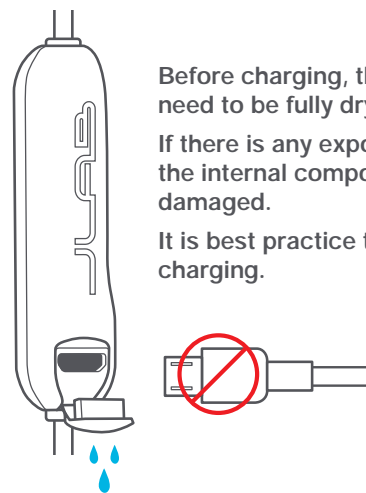

## WARM-UP YOUR HEADPHONES

Optional: Burn-in is the process for exercising new audio equipment. We recommend 40 hours of burn-in time for most headphones to reach optimal performance. The main purpose of the process is to loosen the diaphragm of a newly crafted headphone and to stress the headphone driver. Normal, everyday use can also burn-in the headphones though JLab's proprietary burn-in provides an ideal mix of sounds and frequency sweeps to achieve this.

 Burn-in your audio equipment with the JLab Audio app available on the App Store and Google Play.  
Or access the burn-in method at: [jlabaudio.com/burnin](http://jlabaudio.com/burnin)

## CAUTIONS

- Avoid getting moisture or liquids into the tip of the earbuds or charging port.
- Avoid extreme heat, cold, and humidity.
- Avoid dropping or crushing the earbuds, stressing the cable by rapid pulling or extreme force, or bending the cable at a sharp angle.
- Wax may build up in the earbud tips, lowering the sound quality.

Carefully remove the wax with a cotton swab or other small tool to improve the sound quality.

- If you experience discomfort or pain, try lowering the volume or discontinuing use temporarily.
- If you experience regular discomfort while using this product, discontinue use and consult your physician.
- We recommend you treat your earbuds as you would a nice pair of sunglasses and keep them in safe location when not in use.