

Installation Guide Smart-UPS[™] On-Line APCRBC152/APCRBC141

Safety Messages

Read the instructions carefully to become familiar with the equipment before trying to install, operate, service or maintain it. The following special messages may appear throughout this manual or on the equipment to warn of potential hazards or to call attention to information that clarifies or simplifies a procedure.



The addition of this symbol to a Danger or Warning safety label indicates that an electrical hazard exists which will result in personal injury if the instructions are not followed.



This is the safety alert symbol. It is used to alert you to potential personal injury hazards. Obey all safety messages that follow this symbol to avoid possible injury or death.

CAUTION

CAUTION indicates a potentially hazardous situation which, if not avoided, **can result in** minor or moderate injury.

CAUTION

CAUTION addresses practices not related to physical injury including certain environmental hazards, potential damage or loss of data.



Safety and General Information

**Inspect the package contents upon receipt.
Notify the carrier and dealer if there is any damage.**

- Adhere to all local and national electrical codes.
- Always recycle used batteries.
For information on recycling used battery modules, refer to the Battery Disposal Information sheet included with the replacement battery module.
- Recycle the package materials or save them for reuse.

Battery safety

- Before installing or replacing the batteries, remove jewelry such as wristwatches and rings.
High short circuit current through conductive materials could cause severe burns.
- Do not dispose of batteries by burning them. The batteries may explode.
- Do not open or mutilate batteries. Released electrolyte is harmful to the skin and eyes, and may be toxic.

Replace Battery Modules

⚠ CAUTION

DAMAGE TO EQUIPMENT OR PERSONNEL

- The equipment is heavy. Each APCRBC152 battery module weighs 15.3 kg (33.7 lb) and each APCRBC141 battery module weighs 11.7 kg (25.8 lb).
- Always practice safe lifting techniques adequate for the weight of the equipment.
- Adhere to all local and national electrical codes.
- Use the battery model handle to slide the battery modules in and out of the UPS and external battery pack (XLBP).
- Do not use the handle to lift or carry the battery module.
- When replacing the battery modules, replace with the same type of battery modules.

Failure to follow these instructions can result in equipment damage and minor or moderate injury.

Note: The batteries will charge to 90% capacity in the first three hours of operation on utility power. Do not expect full runtime capability during this initial charge period.

Battery Module	UPS	XLBP
APCRBC152	SRT3000XLx/SRT3000RMLx	SRT96BP/SRT96RMBP
APCRBC141	SRT2200XLx/SRT2200RMLx	SRT72BP/SRT72RMBP

SRT2200XLx/SRT2200RMLx/SRT3000XLx/SRT3000RMLx UPS models

1

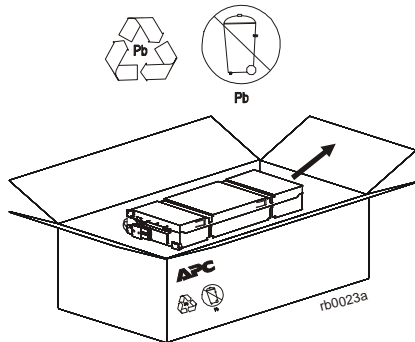

2

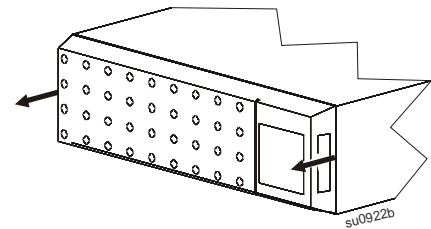

3

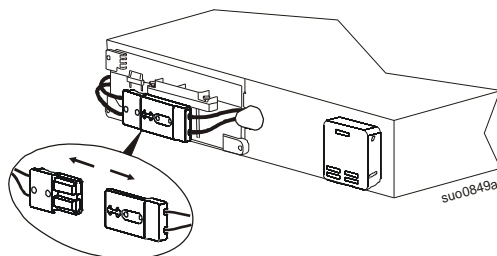

4

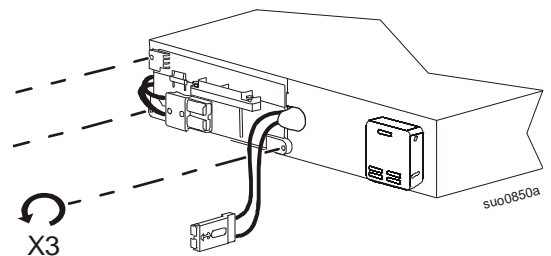

5 APCRBC141

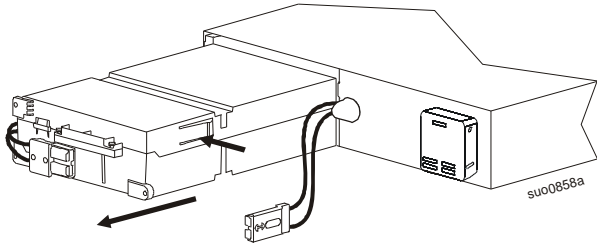

APCRBC152

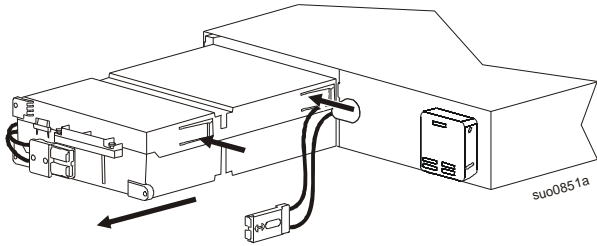

6

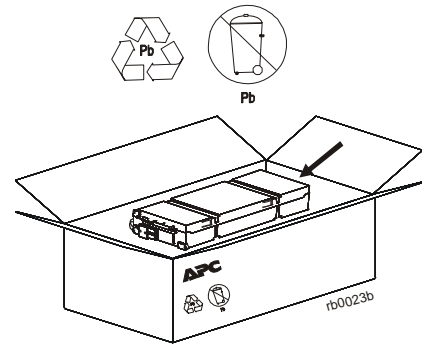

7 APCRBC141

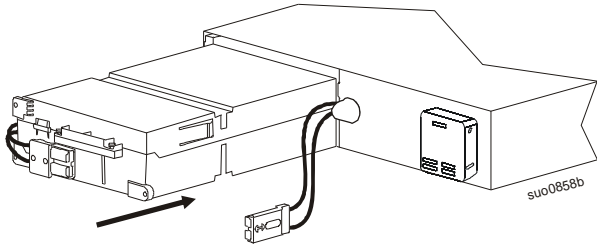

APCRBC152

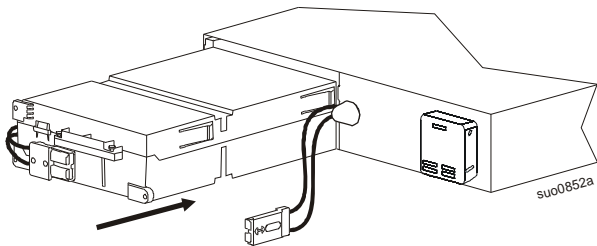

8

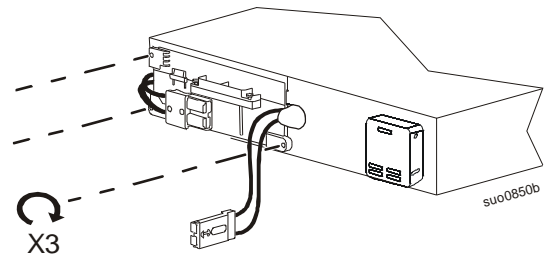

9

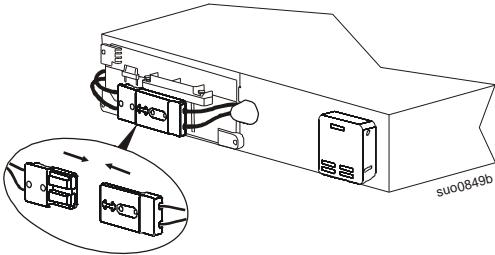

10

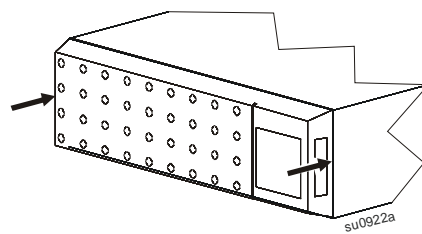

SRT72BP/SRT72RMBP/SRT96BP/SRT96RMBP External battery packs

1

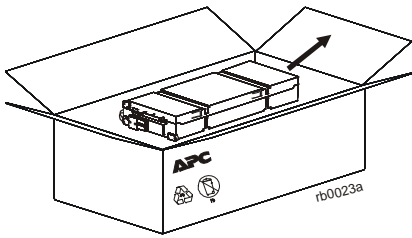
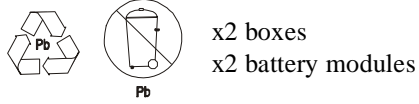

2

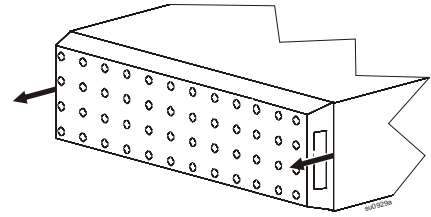

3

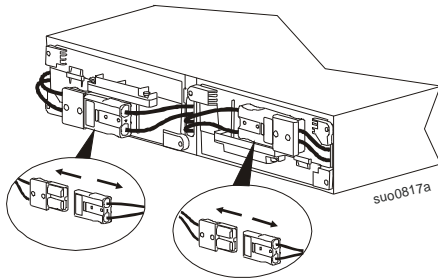

4

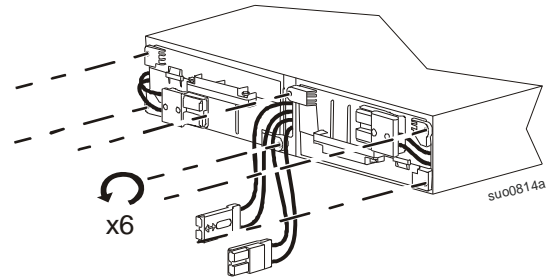

5

APCRBC141

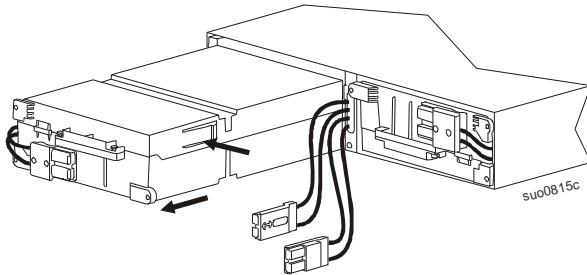

6

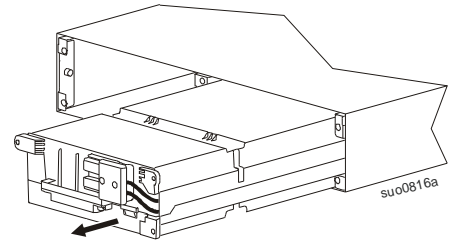

APCRBC152

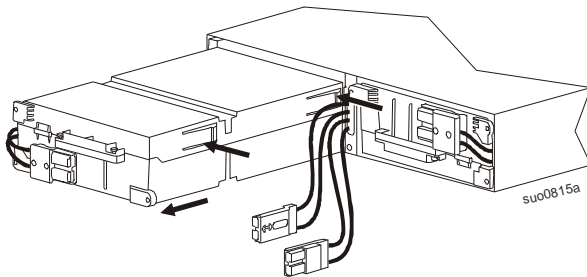

7

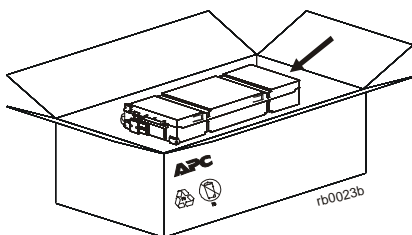
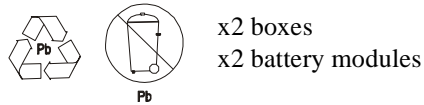

8

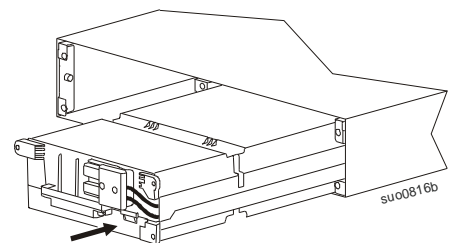

9 APCRBC141

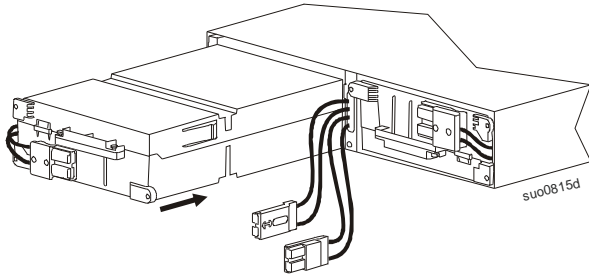

APCRBC152

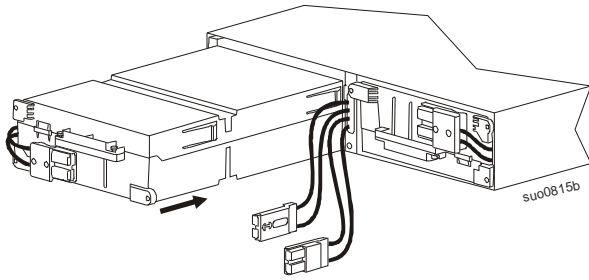

10

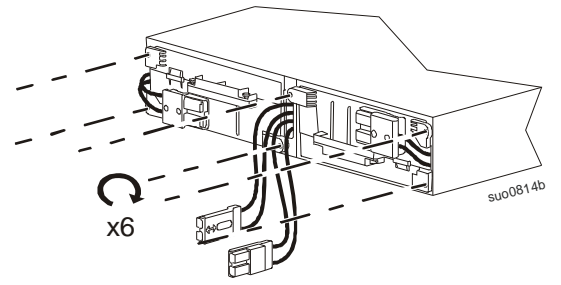

11

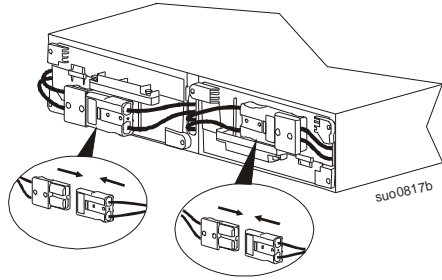

12

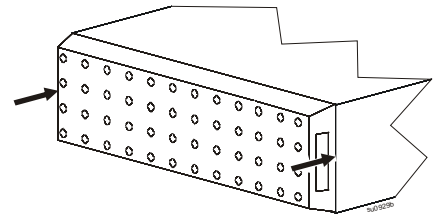

Reset Battery Installation Date

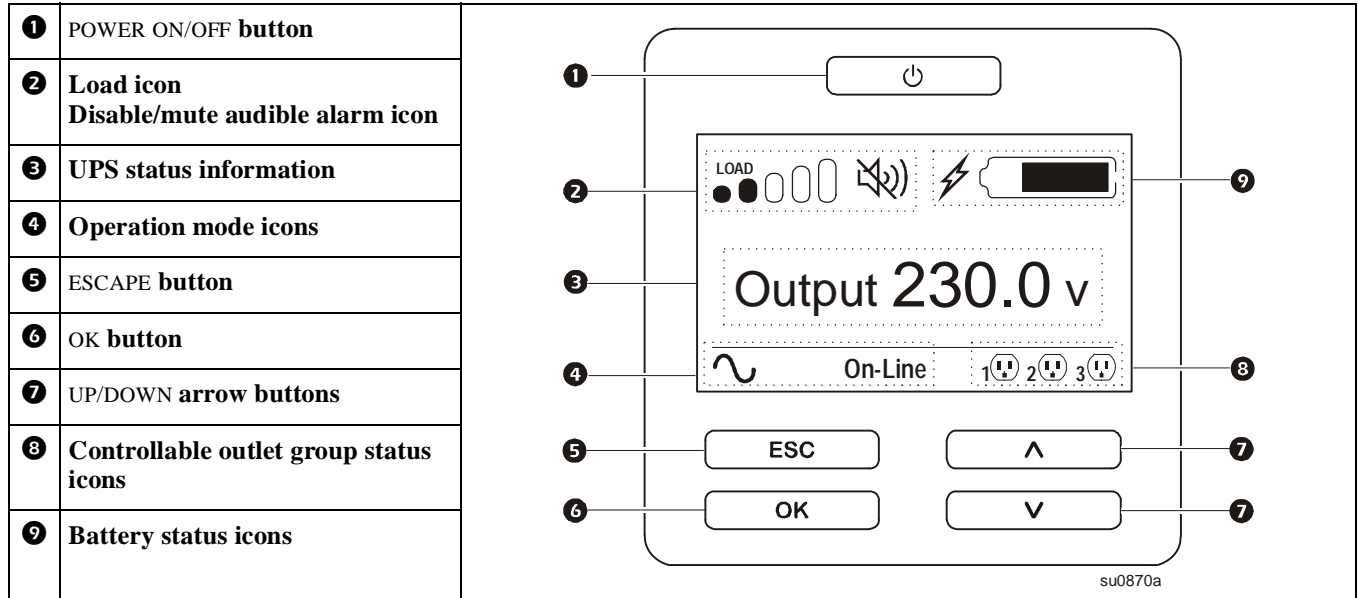

The battery installation date will appear on the display interface within two minutes of battery installation. If the installation date does not appear on the display interface, use the UP/DOWN arrow buttons to navigate to the **Config Menu > Battery** and enter the correct **Installation Date**.

When the replacement battery cartridge (RBC), is charged to full capacity, perform a **Self Test** and a **Runtime Calibration Test**.

Customer support and warranty information are available on the APC web site, www.apc.com.