



# BT785 1

**SYSTEM 2**

**TELESCOPIC CEILING MOUNT  
FOR Ø50MM POLES**

## **INSTALLATION GUIDE & PARTS LIST**

This Pack Contains 1 Ceiling Mount

PLEASE KEEP THIS FOR FUTURE REFERENCE



### **FEATURES**

- Max load 100kg  
(Max weight dependent on mounting plate used)
- Quick tool-less ceiling drop of 600 - 1000mm  
in 25mm increments
- Small ceiling plate with attractive finish
- Cable management
- Cover plate included for smart installation
- Ceiling plate diameter: Ø150mm
- Lower ceiling tube diameter Ø50mm
- Allows micro-adjustment of pole angle
- Longer drop available using  
BT7823-Pole Joiner and any BT7850-Pole  
Mounting Plate, Ø50mm Accessory Collars  
and Interface Plate sold separately

NOT SUITABLE FOR WALL MOUNTING.  
FIXING SCREWS ARE NOT INCLUDED  
WITH THIS PRODUCT.



### **CONTENTS**

Installation Safety Notes.....	2
Parts List.....	4
Installations Instructions.....	5
Product Dimensions.....	7
B-Tech Contact Details.....	8

### **INSTALLATION TOOLS REQUIRED**

Spanner



Drill



Drill Bit



Pencil



**B-TECH AUDIO VIDEO MOUNTS**

[www.btechavmounts.com](http://www.btechavmounts.com)

# INSTALLATION SAFETY INSTRUCTIONS



**CAUTION:** This ceiling mount is intended for use only with the maximum weights indicated.

**Use with flat screens heavier than the maximum indicated may result in instability causing possible injury.**

Do not attempt to install this product until all instructions and warnings have been read and properly understood. Please keep these instructions for future reference. Please check carefully to make sure there are no missing or defective parts - defective parts must never be used. B-Tech International Design & Manufacturing Ltd, its distributors and dealers are not liable or responsible for damage or injury caused by improper installation, improper use or failure to observe these safety instructions. In such cases, all guarantees will expire.

## General

B-Tech International Design & Manufacturing Ltd recommends that a professional AV installer or other suitably qualified person install this product. Great care must always be taken during installation as most AV equipment is of a fragile nature, possibly heavy and easily damaged if dropped.

If you do not fully understand the instructions or are not sure how to install this product safely, then please consult a professional for advice and/or to install this product for you. Failure to mount this product correctly may cause serious injury or death both during installation and at any time thereafter. Do not mount any AV equipment that exceeds the specific weight limit of the product you are installing. This weight limit will be clearly stated on each product and its packaging and will vary from product to product.

## Product location

Please pay careful attention to where this product is located. For indoor use only. Some ceilings are not suitable for installation. If located in a public or frequently populated area ensure that the product is out of the immediate reach of people. If any AV equipment is to be suspended over the likely path or location of people then great care should be taken to secure all parts of the installation from falling. When drilling holes into walls it is essential to avoid contact with electrical cables and water or gas pipes contained within. Use of a good quality live wire detector and hidden object locator is therefore recommended. Only drill into structures when you are sure it is safe to do so.

## Fixing hardware

It is highly recommended that all fixing screws be used where supplied and that the purpose of all other fixing hardware is fully understood. In some cases more AV equipment fixing hardware will be supplied to accommodate different models of equipment and set up configurations. The installer must be satisfied that any supplied fixing hardware is suitable for each specific installation. If any fixing screws or included hardware are deemed not sufficient for a safe installation then please consult a professional or your local hardware store.

## Hazard limitation

When routing cables take advantage of any built in cable management features that the product might provide and ensure that all cables are tidy and secure. Check to see that any moving aspect of the product can do so unhindered by any cabling. Some products have moving parts and the potential to cause injury through the crushing or trapping of fingers or other body parts. Particular attention to the nature of moving parts is required especially when assembling installing and adjusting during set up.

Immediately after installations double-check that the work done is safe and secure. Double-check all necessary fixings are present and are of ample tightness.

It is recommended that periodic inspections of the product and its fixing points are made as frequently as possible to ensure that safety is maintained. If in doubt consult a professional AV installer or other suitably qualified person.

CS

Společnost B-Tech International Design And Manufacturing Ltd. doporučuje provést instalaci tohoto produktu instalátora AV či jinak způsobilé osoby. Společnost B-Tech International Design And Manufacturing Ltd, její distributoři a prodejci nenesou prostřednictvím odborného odpov. édnost za škody nebo zranění způsobená nevhodnou instalací. Tento výrobek je nutno umístit do vhodné konstrukce a používat jen po uvedené maximální výšce.

DE

B-Tech International Design And Manufacturing Ltd. empfiehlt, dass dieses Produkt durch einen qualifizierten AV-Techniker oder eine andere Person mit geeigneter Qualifikation installiert wird. B-Tech International Design And Manufacturing Ltd, ihre Distributoren und Händler können nicht für durch fehlerhafte Montage verursachte Beschädigung oder Verletzung haftbar bzw. verantwortlich gemacht werden. Dieses Produkt muss auf eine geeignetem Untergrund montiert werden und darf nur bis zum angegebenen Höchstgewicht verwendet werden.

ES

B-Tech International Design And Manufacturing Ltd. recomienda que un instalador de audio y video profesional u otra persona debidamente cualificada instalen este producto. B-Tech International Design And Manufacturing Ltd, sus distribuidores y concesionarios no se hacen cargo ni se responsabilizan de ningún daño o lesión provocados por una instalación inapropiada. Este producto se debe montar en una estructura adecuada y se debe utilizar soportando solamente hasta el peso máximo indicado.

FR

B-Tech International Design And Manufacturing Ltd. recommande de confier l'installation de ce produit à un installateur AV professionnel ou à une autre personne dûment qualifiée. B-Tech International Design And Manufacturing Ltd, ses distributeurs et ses revendeurs ne sauraient être tenus responsables de tout dégât ou de toute blessure résultant d'une installation incorrecte. Ce produit doit être monté sur un support approprié et utilisé dans la limite du poids maximum indiqué.

IT

B-Tech International Design And Manufacturing Ltd. consiglia di affidare l'installazione di questo prodotto a un installatore specializzato o ad altra persona adeguatamente qualificata. B-Tech International Design And Manufacturing Ltd, i suoi distributori e rivenditori non accettano alcuna responsabilità nei riguardi di eventuali danni o infortuni causati da un'errata installazione. Questo prodotto deve essere fissato a una struttura idonea e utilizzato unicamente sino al peso massimo indicato.

NL

B-Tech International Design And Manufacturing Ltd. adviseert om dit product te laten installeren door een professionele AV-instalateur of andere hiervoor gekwalificeerde persoon. B-Tech International Design And Manufacturing Ltd, haar distributeurs en dealers zijn niet aansprakelijk of verantwoordelijk voor schade of letsel die is veroorzaakt door onoordeelkundige installatie. Dit product moet worden gemonteerd aan een geschikte constructie, waarbij het aangegeven maximum gewicht niet mag worden overschreden.

PL

Firma B-Tech International Design And Manufacturing Ltd. zaleca, aby ten produkt był instalowany przez profesjonalnych instalatorów AV lub inny odpowiednio przeszkolony personel. Firma B-Tech International Design And Manufacturing Ltd, jej dystrybutorzy i dealerzy nie ponoszą odpowiedzialności za uszkodzenia lub obrażenia ciała powstałe w wyniku nieprawidłowej instalacji. Niniejszy produkt musi być zamontowany na odpowiedniej powierzchni, a podczas u żytkowania nie wolno przekraczać podanego maksymalnego obciążenia.

PT

A B-Tech International Design And Manufacturing Ltd. recomenda que a instalação deste produto seja efectuada por um instalador de AV instalador de AV profissional ou outra pessoa devidamente habilitada. A B-Tech International Design And Manufacturing Ltd. e os seus distribuidores e concessionários não são responsáveis por danos ou lesões causados por uma instalação incorrecta. Este produto tem de ser montado numa estrutura adequada e utilizado somente até ao peso máximo indicado.

RU

Компания B-Tech International Design And Manufacturing Ltd. рекомендует, чтобы установка данного изделия производилась инженером по установке аудио-видеотехники или другим специалистом с соответствующей квалификацией. Компания B-Tech International Design And Manufacturing Ltd. ее дистрибьюторы и дилеры не несут ответственности за повреждения или травмы, полученные в результате неправильной установки. Данное изделие должно

توصي بي- تك للتجارة الدولية المحدودة بأن شخص محترف في تركيب ال AV أو شخص مؤهل تأهيلا مناسباً لتركيب هذا المنتج. بي- تك للتجارة الدولية، موز عليها والتجار ليست عرضة أو مسؤولة عن الأضرار أو الإصابات الناجمة عن تركيب غير سليم، والاستخدام غير السليم أو عدم مراعاة هذه التعليمات للسلامة. يجب أن يتم تركيب هذا المنتج في بنية مناسبة ويجب استخدامة فقط لدعم الحد الأقصى للوزن المشار إليه.

**BT785 1  
PARTS LIST**

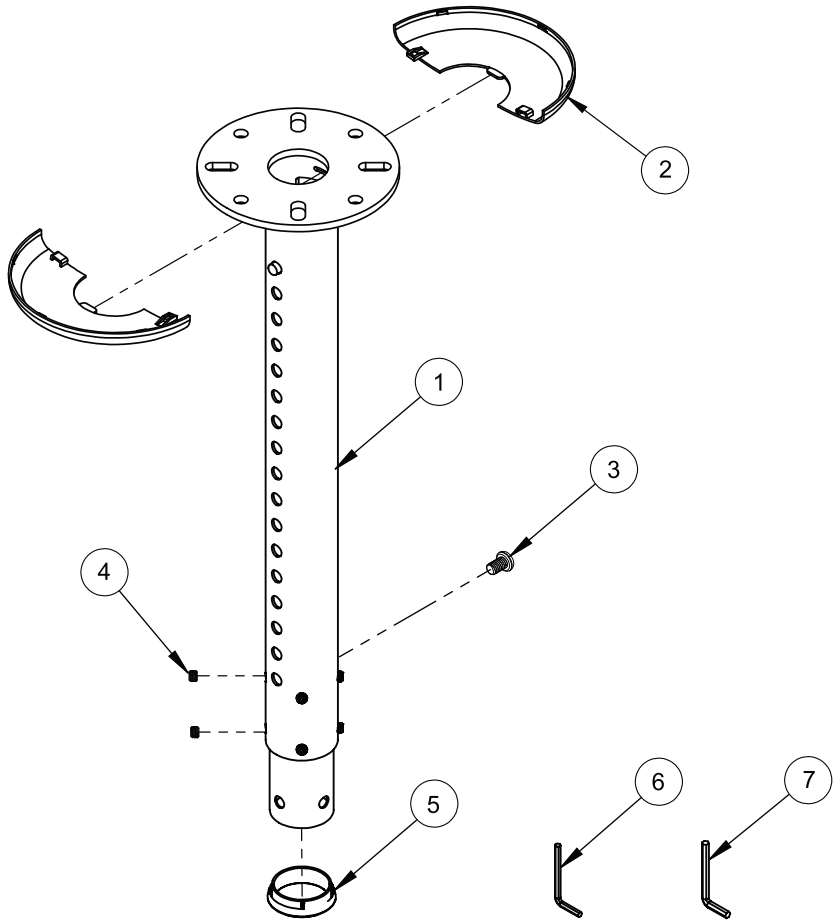

REF	PART NAME	QTY
1	ADJUSTABLE POLE	1
2	COVER PLATE HALF	2
3	M8 x 12mm HEX SCREW	1
4	M8 x 6mm GRUB SCREW	8
5	POLE END RING	1
6	4mm HEX KEY	1
7	5mm HEX KEY	1

Suitable for loads  
up to 90kg

PLEASE KEEP FOR FUTURE REFERENCE

# INSTALLATION INSTRUCTIONS

1

## Attach to Ceiling

i. Fix the adjustable pole (part 1) to the ceiling.

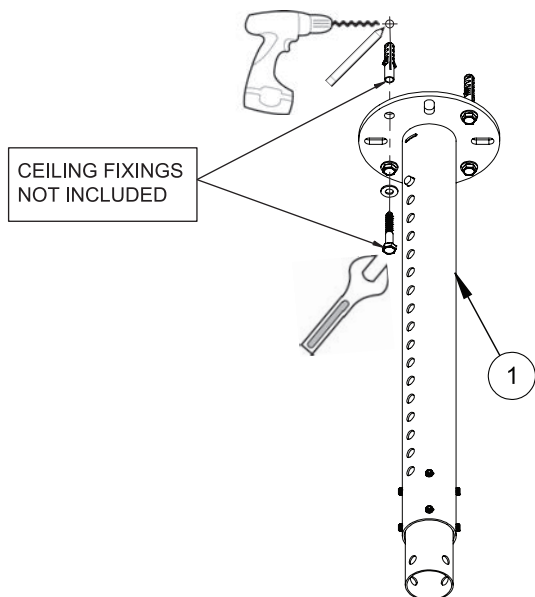

ii. Attach cover plates (part 2) to the ceiling plate on the adjustable pole.

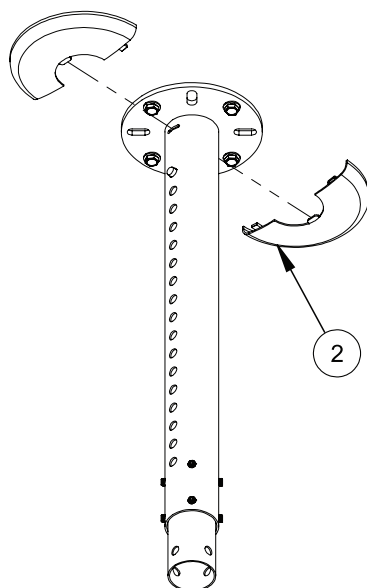

## 2 Adjust Ceiling Drop to desired height

i) Push spring button to release height adjustment.

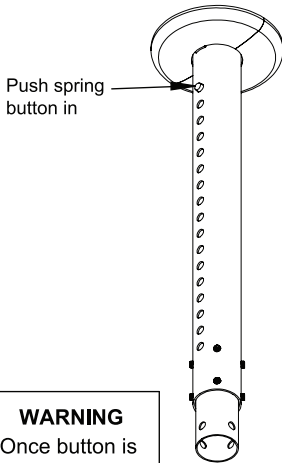

**WARNING**  
Once button is pushed in, the inner pole will fall to maximum extension if not held.

ii) Move inner sliding pole to desired ceiling drop.

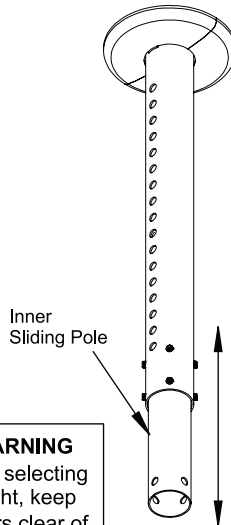

**WARNING**  
When selecting height, keep fingers clear of safety slot on reverse of pole.

iii) When desired ceiling drop is reached, ensure spring button protrudes from hole.

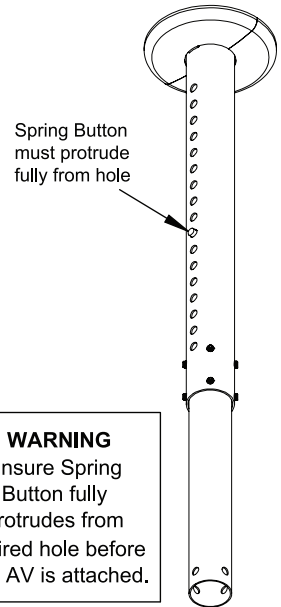

**WARNING**  
Ensure Spring Button fully protrudes from desired hole before any AV is attached.

## 3 Attach Pole End Ring

Push pole end ring (part 5) fully onto the inner sliding pole once mount is attached as shown.

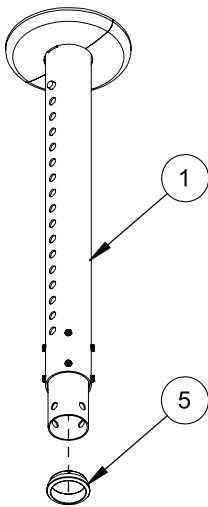

## 4 Fix Inner Sliding Pole in place

Tighten grub screws (part 4) using the 4mm Hex Key (part 6) to ensure inner sliding pole is fixed securely in position.

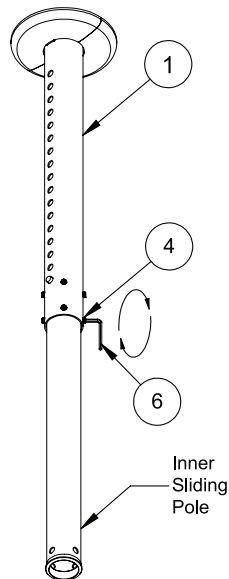

**Note:** The angle of the inner sliding pole can be adjusted using the grub screws (part 4) provided and the 4mm Hex Key (part 6).

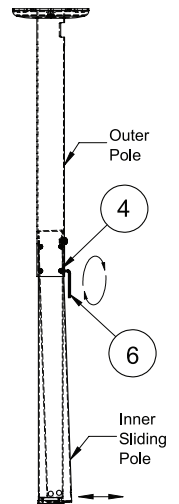

# BT785 1

## PRODUCT DIMENSIONS

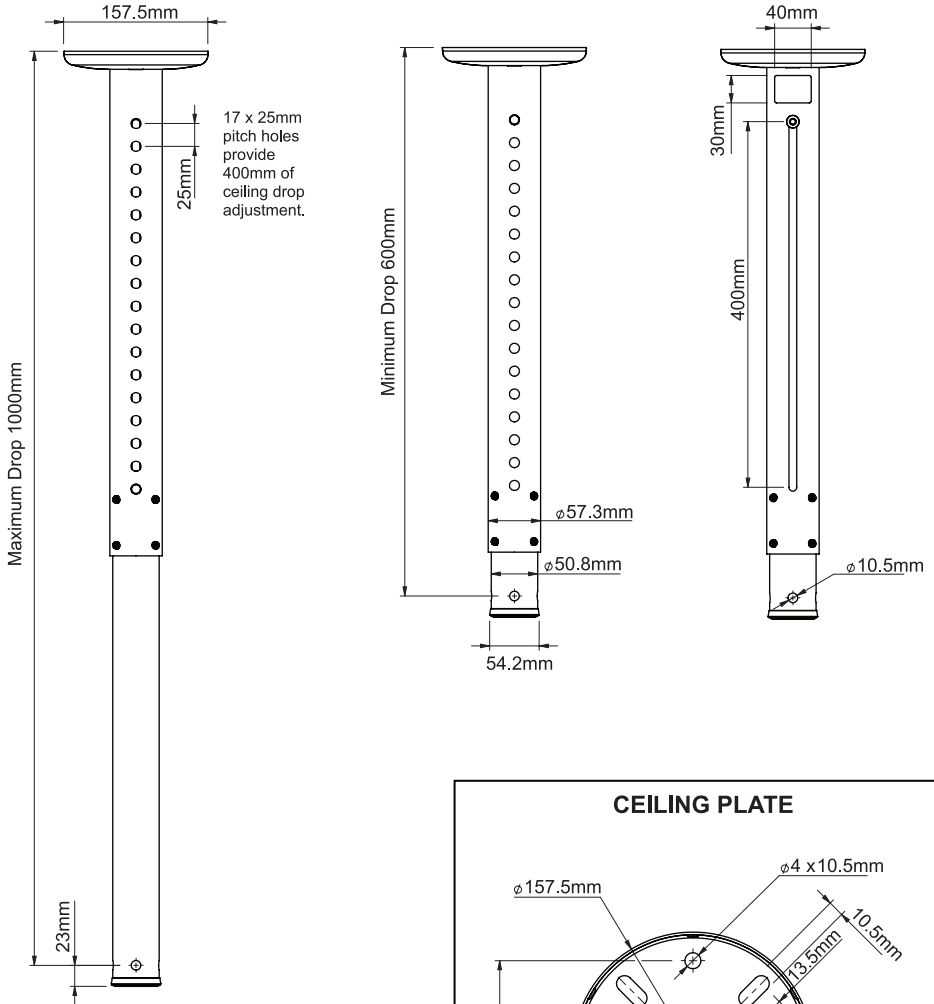

B-Tech 'SYSTEM 2' compatible.  
 Accepts B-Tech 50mm accessory collars.

Minimum ceiling drop = 600mm  
 Maximum ceiling drop = 1000mm (1M).

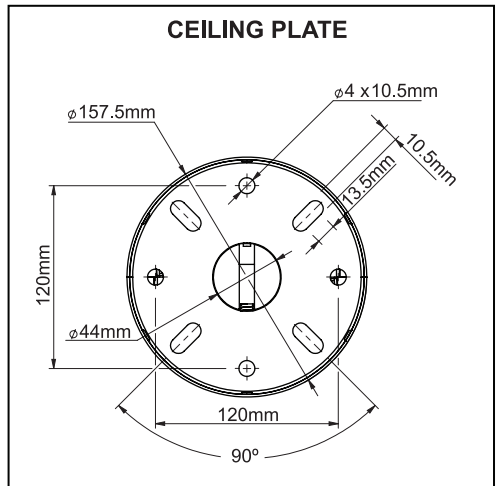

THESE INSTRUCTIONS ARE INTENDED AS A GUIDE ONLY AND B-TECH ACCEPTS NO LIABILITY FOR THE ACCURACY OF THE INFORMATION CONTAINED IN THIS DOCUMENT.



[www.btechavmounts.com](http://www.btechavmounts.com)

## **B-TECH AUDIO VIDEO MOUNTS**

### **HEAD OFFICE**

#### **B-Tech International Limited**

Bennett House, Long March, Daventry, Northants., NN11 4NR, UK

Email: [info@btechavmounts.com](mailto:info@btechavmounts.com)

©2017 B-Tech International Design and Manufacturing Limited. All rights reserved.

B-Tech Audio Video Mounts is a division of B-Tech International Design and Manufacturing Limited.

B-Tech, Better By Design & System X are registered trademarks of B-Tech International Design and Manufacturing Limited.

All other brands and product names are trademarks of their respective owners.

Photographs are for illustrative purposes only. E&OE.