

# Dell E2725H Monitor

## Service Manual

## Notes, cautions, and warnings

 **NOTE:** A NOTE indicates important information that helps you make better use of your product.

 **CAUTION:** A CAUTION indicates either potential damage to hardware or loss of data and tells you how to avoid the problem.

 **WARNING:** A WARNING indicates a potential for property damage, personal injury, or death.

# Contents

<b>Safety Instructions</b> .....	<b>3</b>
<b>Before working inside your monitor</b> .....	<b>3</b>
<b>After working inside your monitor</b> .....	<b>3</b>
<b>Views of E2725H Monitor</b> .....	<b>4</b>
<b>Front view</b> .....	<b>4</b>
<b>Side view and back view</b> .....	<b>4</b>
<b>Bottom view</b> .....	<b>5</b>
<b>Major components of E2725H monitor</b> .....	<b>6</b>
<b>Wiring connectivity diagram</b> .....	<b>8</b>
<b>Connecting the cables</b> .....	<b>9</b>
<b>Disassembly and reassembly</b> .....	<b>10</b>
<b>Recommended tools</b> .....	<b>10</b>
<b>Stand</b> .....	<b>10</b>
Removing the stand .....	10
Installing the stand .....	11
<b>VESA cover</b> .....	<b>11</b>
Removing the VESA cover .....	11
Installing the VESA cover .....	12
<b>Back cover</b> .....	<b>13</b>
Removing the back cover .....	13
Installing the back cover .....	14
<b>Keypad board</b> .....	<b>14</b>
Removing the keypad board .....	14
Installing the keypad board .....	16
<b>Metal frame</b> .....	<b>17</b>
Removing the metal frame .....	17
Installing the metal frame .....	18
<b>Main board and power board</b> .....	<b>20</b>
Removing the main board and power board .....	20
Installing the main board and power board .....	22
<b>Troubleshooting</b> .....	<b>26</b>
<b>Self-Test</b> .....	<b>26</b>
<b>Onboard diagnostics</b> .....	<b>27</b>
<b>Common problems</b> .....	<b>28</b>
<b>Product-specific problems</b> .....	<b>29</b>
<b>Contacting Dell</b> .....	<b>30</b>

# Safety Instructions

Use the following safety guidelines to protect your monitor from potential damage and to ensure your personal safety. Unless otherwise noted, each procedure included in this document assumes that you have read the safety information that shipped with your monitor.

**NOTE:** Before using the monitor, read the safety information that is shipped with your monitor and printed on the product. Keep the documentation at a secure location for future reference.

**WARNING:** Use of controls, adjustments or procedures other than those specified in this documentation may result in exposure to shock, electrical hazards and/or mechanical hazards.

**CAUTION:** The possible long-term effect of listening to audio at high volume through the headphones (on monitor that support it) may cause damage to your hearing ability.

- Place the monitor on a solid surface and handle it carefully. The screen is fragile and can be damaged if dropped or hit with a sharp object.
- Ensure that your monitor is electrically rated to operate with the AC power available in your location.
- Keep the monitor in room temperature. Excessive cold or hot conditions can have an adverse effect on the liquid crystal of the display.
- Connect the power cable from the monitor to a wall outlet that is near and accessible. See Connecting the cables.
- Do not place and use the monitor on a wet surface or near water.
- Do not subject the monitor to severe vibration or high impact conditions. For example, do not place the monitor inside a car trunk.
- Unplug the monitor when it is going to be left unused for an extended period.
- To avoid electric shock, do not attempt to remove any cover or touch the inside of the monitor.
- Read these instructions carefully. Keep this document for future reference. Follow all warnings and instructions marked on product.
- Certain monitors can be wall mounted using the VESA mount that is sold separately. Ensure to use the correct VESA specifications as mentioned in the wall mounting section of the User's Guide.

For information on safety instructions, see the Safety, Environmental and Regulatory Information (SERI) document that is shipped with your monitor.

## Before working inside your monitor

### Steps

1. Save and close all open files and exit all open applications.
  2. Turn off your monitor.
  3. Disconnect your monitor and all attached devices from their electrical outlets.
  4. Disconnect all attached network devices and peripherals, such as keyboard, mouse, and dock from your monitor
- CAUTION:** To disconnect a network cable, first unplug the cable from your monitor and then unplug the cable from the network device.
5. Remove any media card and optical disc from your monitor, if applicable.

## After working inside your monitor

**CAUTION:** Leaving stray or loose screws inside your monitor may severely damage your monitor. Protecting Against Electrostatic Discharge

### Steps

1. Replace all screws and ensure that no stray screws remain inside your monitor..
2. Connect any external devices, peripherals, or cables you removed before working on your monitor.
3. Replace any media cards, discs, or any other parts that you removed before working on your monitor.
4. Connect your monitor and all attached devices to their electrical outlets.
5. Turn on your monitor.

# Views of E2725H Monitor

## Front view

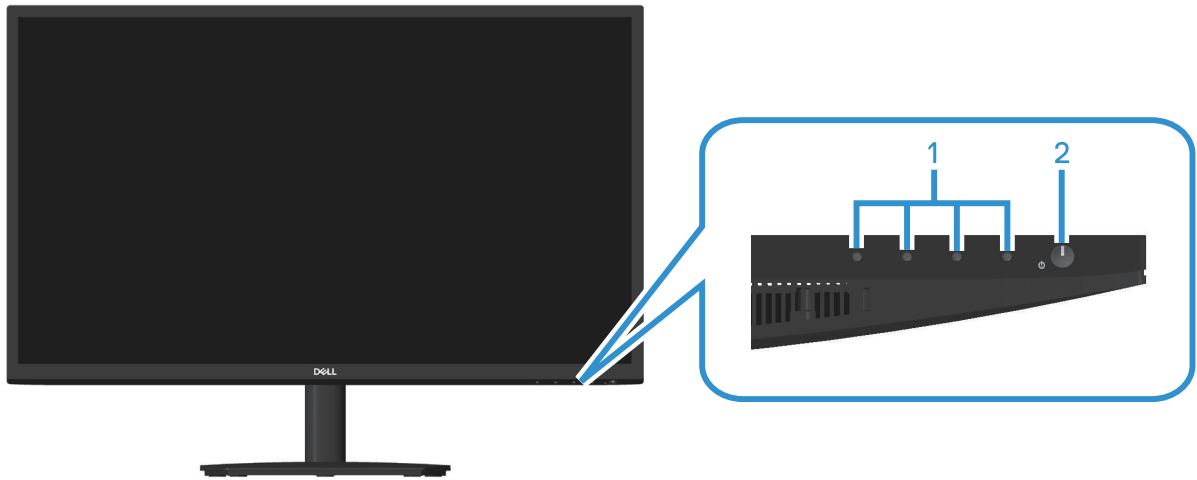
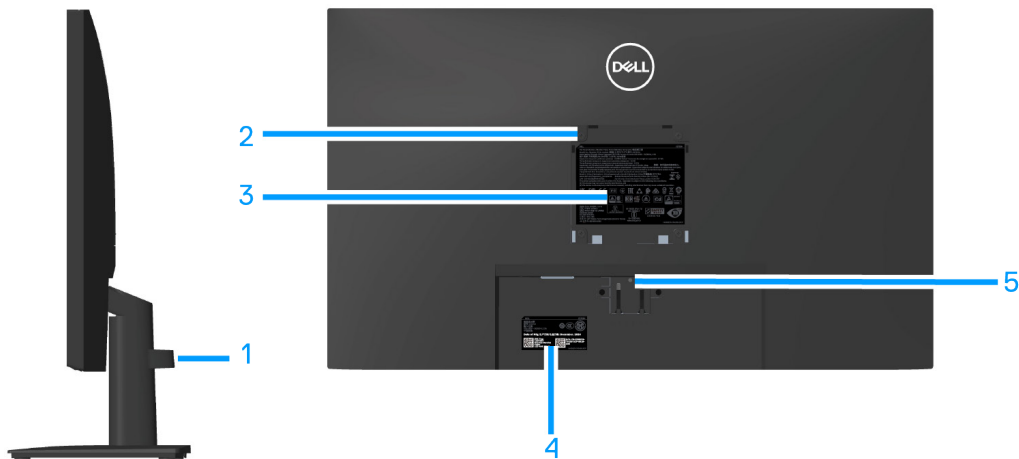

**Figure 1.** Front view of the monitor

**Table 1.** Components and descriptions.

Label	Description	Use
1	Function buttons	To access the on-screen display (OSD) menu. (For more information, see <a href="#">Using the control buttons</a> )
2	Power button (LED indicator)	To turn the monitor on or off. Solid white light indicates that the monitor is turned on and functioning. Blinking white light indicates that the monitor is in Standby Mode.

## Side view and back view



**Figure 2.** Side view and back view of the monitor

**Table 2.** Components and descriptions.

Label	Description	Use
1	Cable Management Clip	Organizes the cables when the cables are routed through the slot.
2	VESA mounting holes (100 mm x 100 mm-behind the VESA cover)	<a href="#">Wall mounting (optional)</a> the monitor using VESA-compatible wall mount kit (100 mm x 100 mm). <b>i NOTE:</b> Wall mount kit is not shipped with your monitor and is sold separately.
3	Regulatory information label	Lists the regulatory approvals.
4	Regulatory labels (including Barcode, serial number and Service Tag label)	Lists the regulatory approvals. See this label if you must contact Dell for technical support. The Service Tag is a unique alphanumeric identifier that enables Dell service technicians to identify the hardware components in your computer and access warranty information.
5	Stand release button	Release the stand from monitor.

## Bottom view



**Figure 3.** Bottom view of the monitor (E2725H)

**Table 3.** Components and descriptions.

Label	Description	Use
1	Security-lock slot (based on Kensington Security Slot)	Secure your monitor using a security lock (purchased separately) to prevent unauthorized movement of your monitor.
2	Power port	Connect the power cable.
3	DP port	Connect your computer with DP cable.
4	VGA port	Connect your computer with VGA cable.

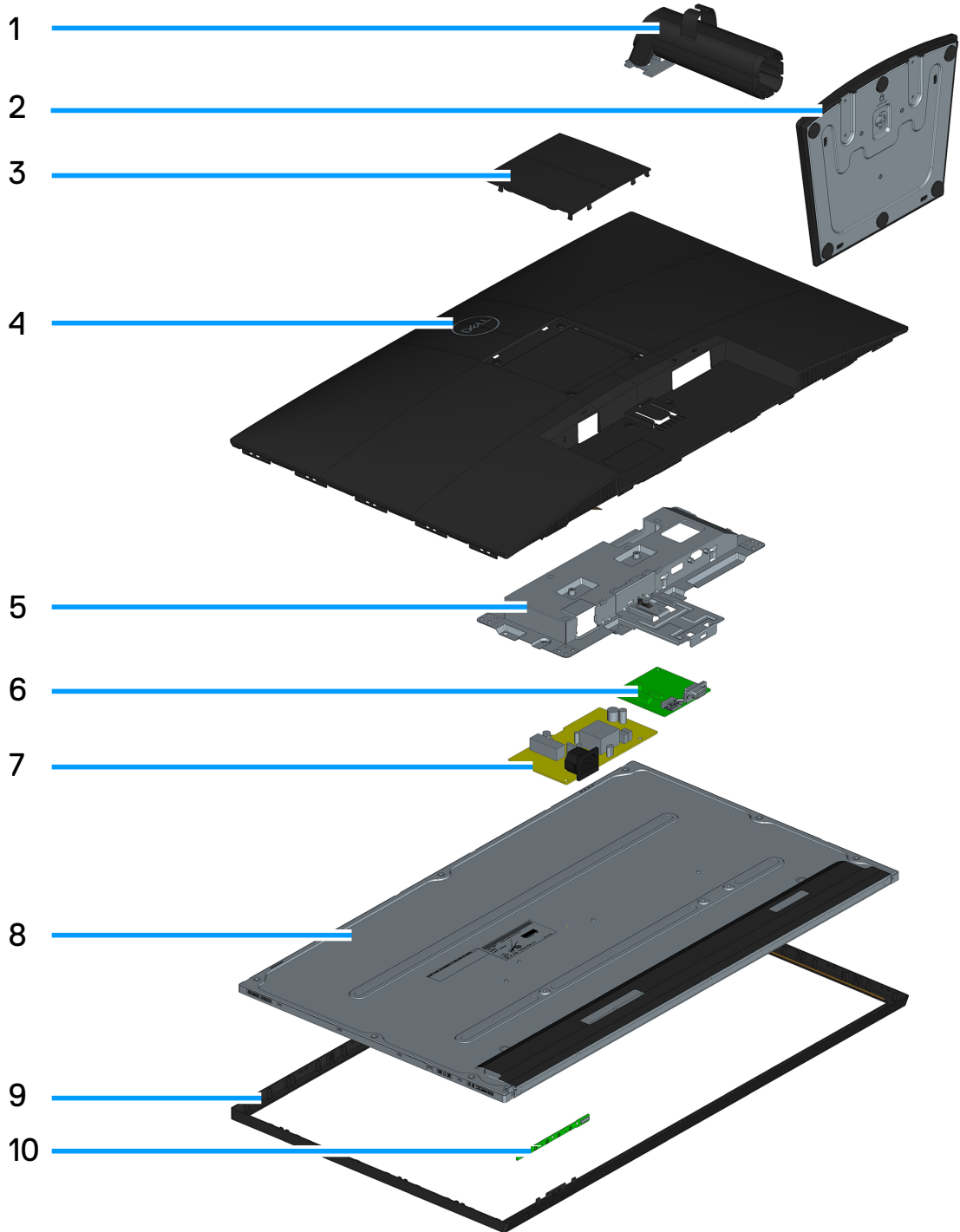

**Figure 4.** Bottom view of the monitor (SE2725H)

**Table 4.** Components and descriptions.

Label	Description	Use
1	Security-lock slot (based on Kensington Security Slot)	Secure your monitor using a security lock (purchased separately) to prevent unauthorized movement of your monitor.
2	Power port	Connect the power cable
3	HDMI port	Connect your computer with HDMI cable.
4	VGA port	Connect your computer with VGA cable

# Major components of E2725H monitor



**Table 1.** Components.

No.	Description
1	Stand riser
2	Stand base
3	VESA cover
4	Back cover
5	Metal frame
6	Main board
7	Power board
8	Panel
9	Bazel
10	Keypad board

**NOTE:**

For replacement of power cord, connectivity cable and external power supply (if applicable), contact Dell:

1. Go to <https://www.dell.com/support>.
2. Verify your country or region in the Choose A Country/Region drop-down menu at the bottom-right corner of the page.
3. Click Contact Us next to the country dropdown.
4. Select the appropriate service or support link based on your need.
5. Choose the method of contacting Dell that is convenient for you



## Wiring connectivity diagram

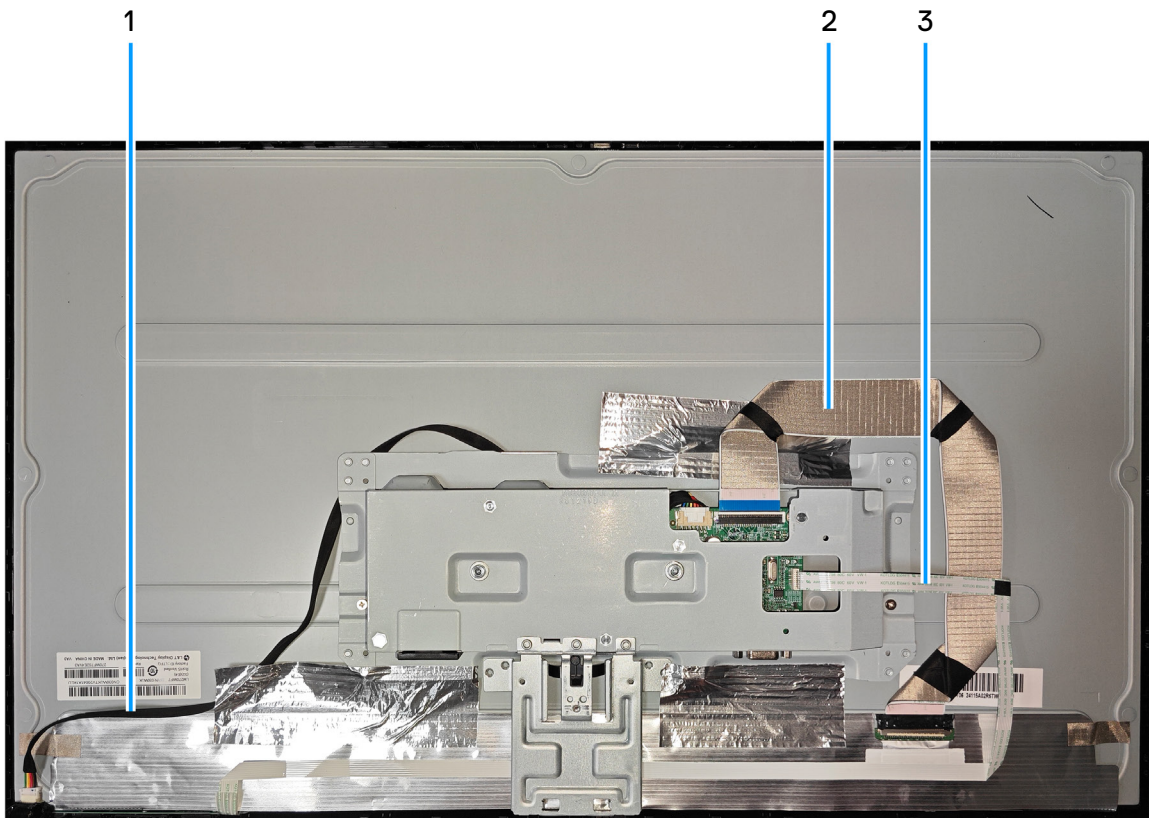

Item	Description
1	Lightbar Cable
2	LVDS Cable
3	Keypad Cable

# Connecting the cables

**⚠ WARNING:** Before you begin any of the procedures in this section, follow the [Safety instructions](#).

**① NOTE:** Dell monitors are designed to work optimally with the video cables that are shipped with your monitor. Dell cannot guarantee the video performance of cables that are not included with your Dell monitor, as it has no control over suppliers, materials, connectors, and manufacturing processes.

**① NOTE:** Route the cables through the cable-management slot before connecting them.

**① NOTE:** Do not connect all cables to the computer simultaneously.

**① NOTE:** The images are for illustration only. The appearance of the computer may vary.

To connect your monitor to the computer:

1. Turn off your computer and disconnect the power cable.
2. Connect the VGA cable or DP cable or HDMI cable from your monitor to the computer.

## Connecting the VGA Cable and DP Cable (E2725H)

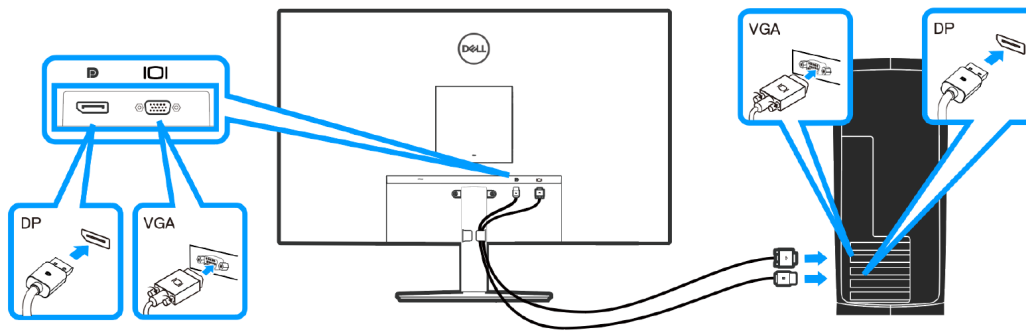

**Figure 1.** Connecting the VGA Cable and DP Cable (E2725H)

## Connecting the VGA Cable (optional) and HDMI Cable (SE2725H)

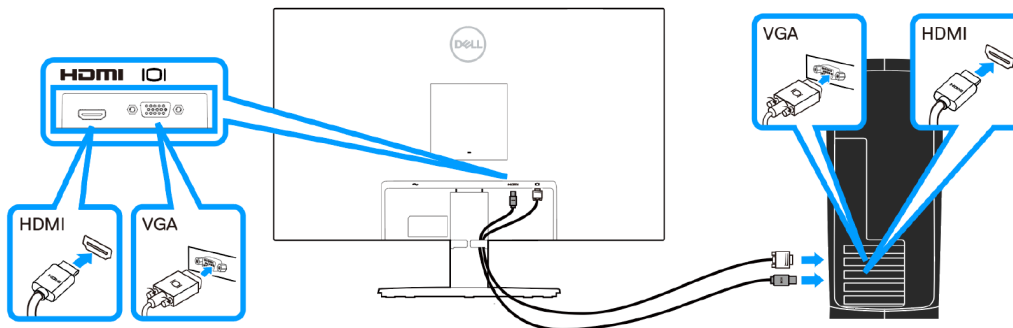

**Figure 2.** Connecting the VGA Cable and HDMI Cable (SE2725H)

3. Connect the power cables from your computer and monitor into a wall outlet.

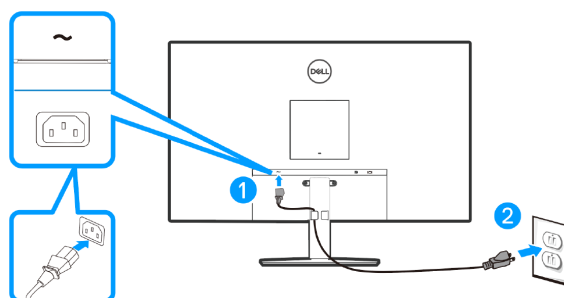

**Figure 3.** Connect the power cables

# Disassembly and reassembly

## NOTE:

This “Disassembly and Assembly Procedures” is for EMEA only, not for other regions. Please note that Dell will deem warranty void if any disassembly is done on the monitors.

## Recommended tools

List the type and size of the tools that would typically can be used to disassemble the product to a point where components and materials requiring selective treatment can be removed.

Tool Description:

- Screwdriver (Phillip-head, Hexagonal head)
- Penknife

## Stand

### Removing the stand

#### Prerequisites

1. Follow the procedure in [Before working inside your monitor](#).

#### Steps

1. Place the monitor on a soft cloth or cushion at the edge of the desk.
2. Using a long screwdriver press the release button.
3. While keeping the release button pressed, pull the stand out.

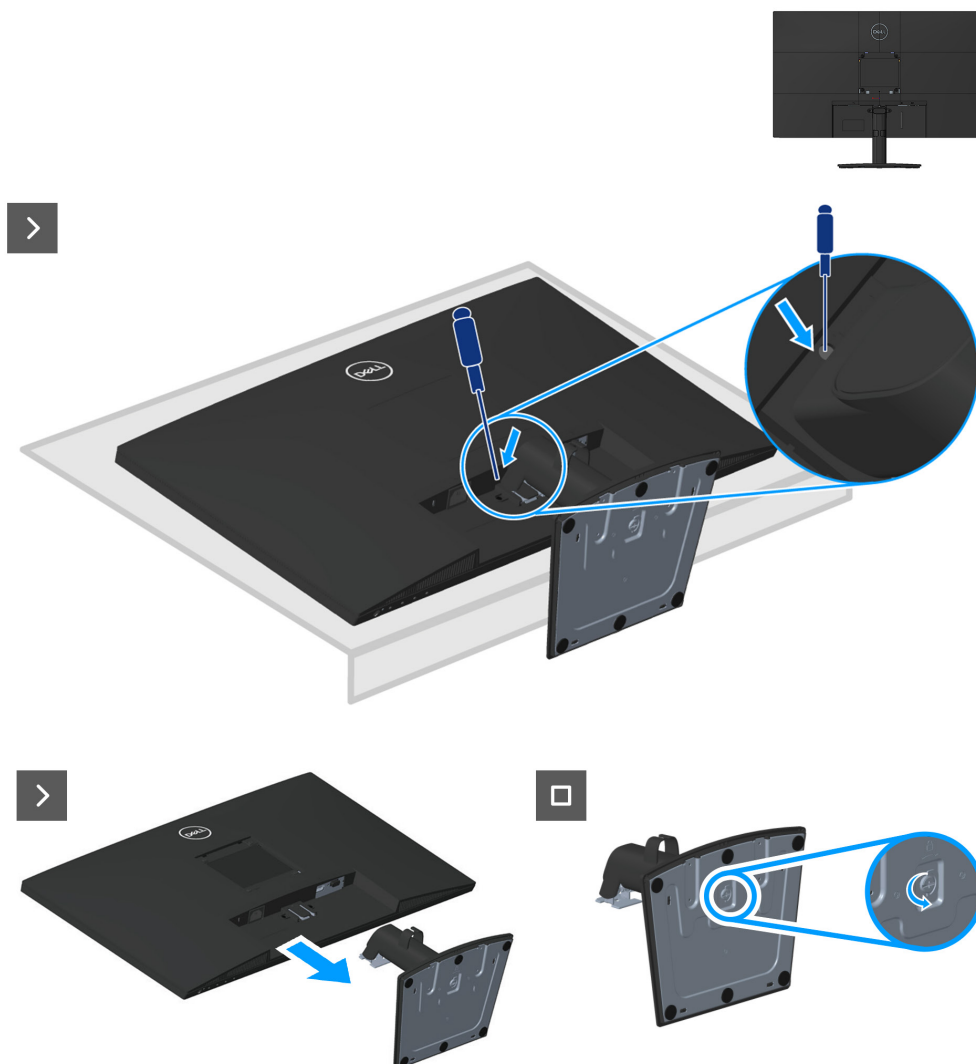

## Installing the stand

### Steps

1. Slide the tabs on the stand assembly into the slots on the monitor and press the stand assembly down to snap it into place.

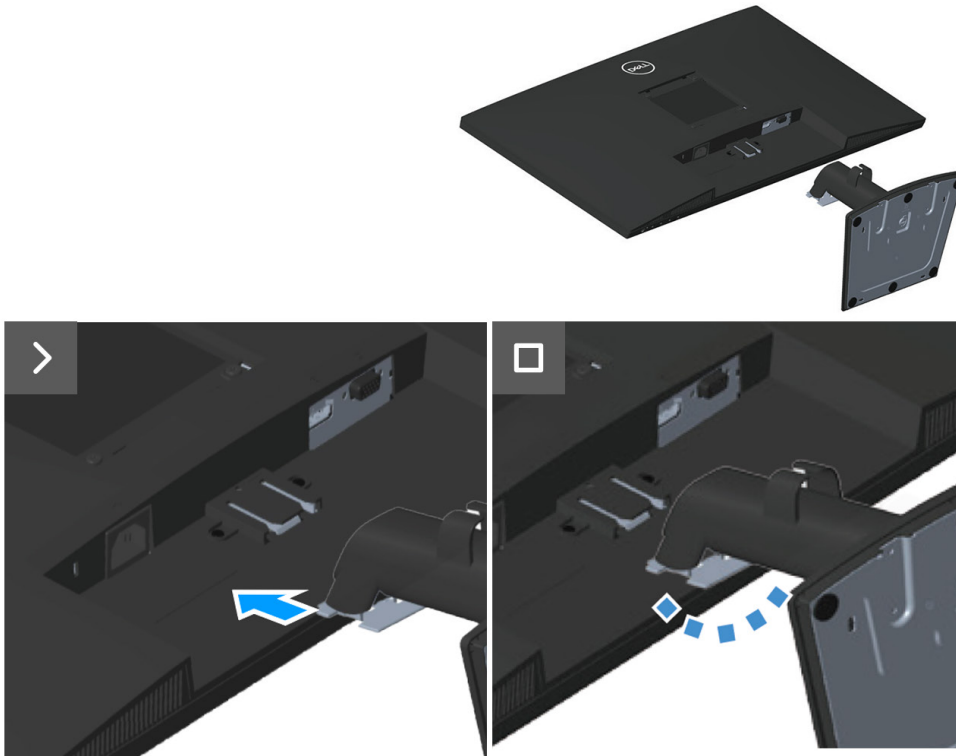

### Next steps

1. Follow the procedure in [After working inside your monitor.](#)

## VESA cover

### Removing the VESA cover

#### Prerequisites

1. Follow the procedure in [Before working inside your monitor.](#)
2. [Removing the stand.](#)

#### Steps

1. Press the dimple on the VESA cover to release it from the back of the display.

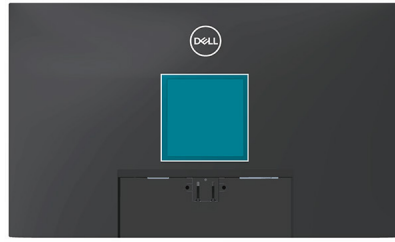

## Installing the VESA cover

### Steps

1. Press the VESA cover to install it to the back cover.

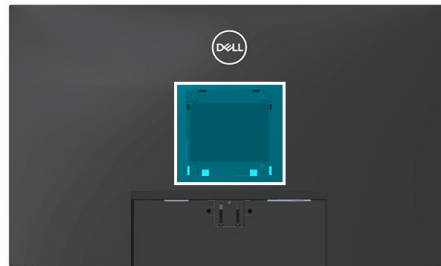

### Next steps

1. [Installing the stand.](#)
2. Follow the procedure in [After working inside your monitor.](#)

## Back cover

### Removing the back cover

#### Prerequisites

1. Follow the procedure in [Before working inside your monitor.](#)
2. [Removing the stand.](#)
3. [Removing the VESA cover.](#)

#### Steps

1. Remove four screws (M4x10) that secure the back cover to the chassis assembly.
2. Remove two screws (M3x6) that secure the back cover to the chassis assembly.

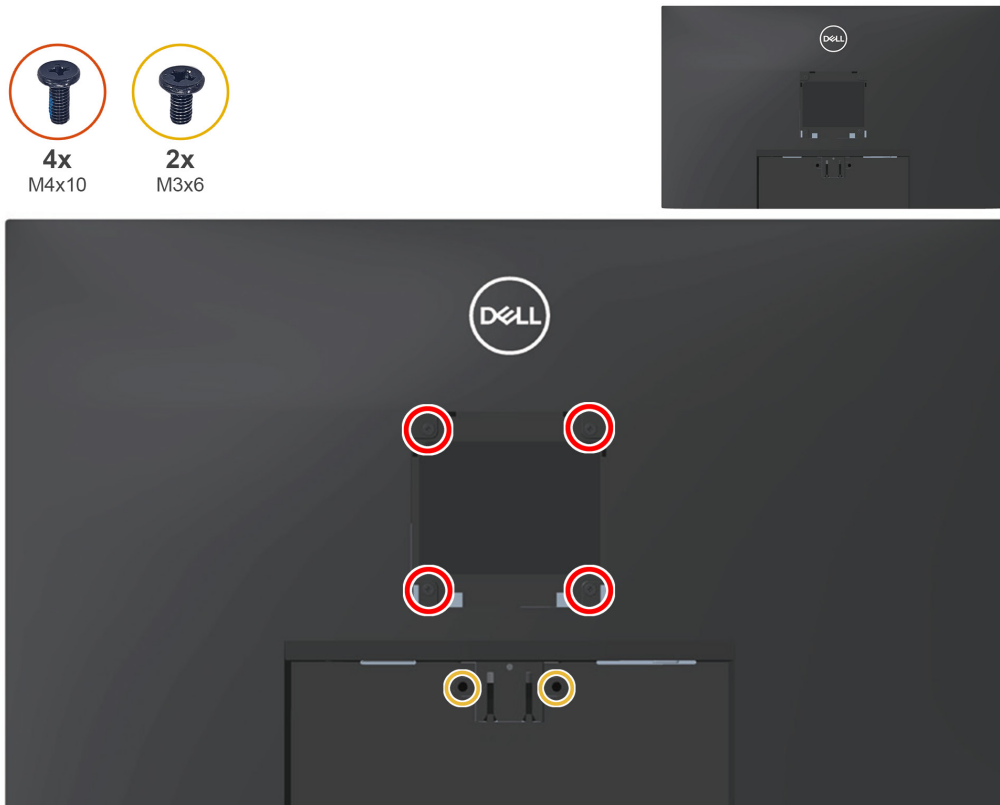

3. Using the plastic scribe, pry the back cover starting from the bottom edge of the monitor.



4. Lift and remove the back cover away from the monitor.

## Installing the back cover

### Steps

1. Place and snap the back cover into place the chassis assembly.

**NOTE:** Align the screw holes on the back cover with the screw holes on the chassis assembly before applying slight pressure to the back cover.

2. Replace four screws (M4x10) to secure the back cover to the monitor.

3. Replace two screws (M3x6) to secure the back cover to the monitor.

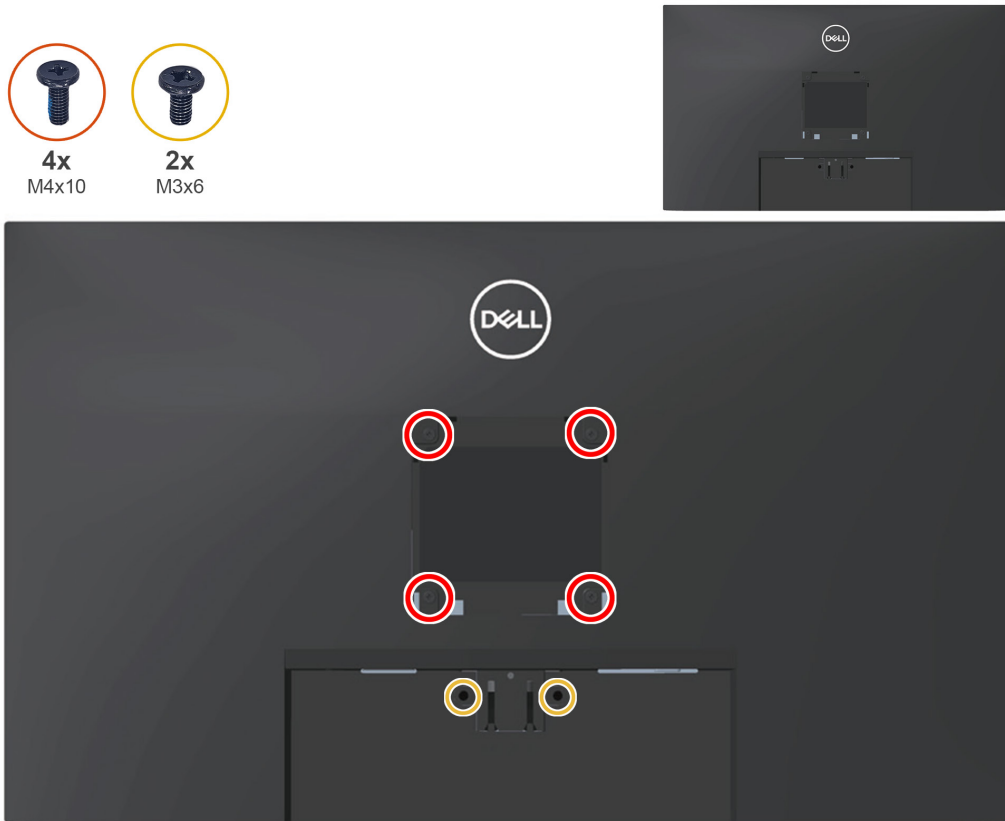

### Next steps

1. [Installing the VESA cover.](#)

2. [Installing the stand.](#)

3. Follow the procedure in [After working inside your monitor.](#)

## Keypad board

### Removing the keypad board

#### Prerequisites

1. Follow the procedure in [Before working inside your monitor.](#)

2. [Removing the stand.](#)

3. [Removing the VESA cover.](#)

4. [Removing the back cover.](#)

#### Steps

1. Disconnect keypad board cable from the connector on the main board.

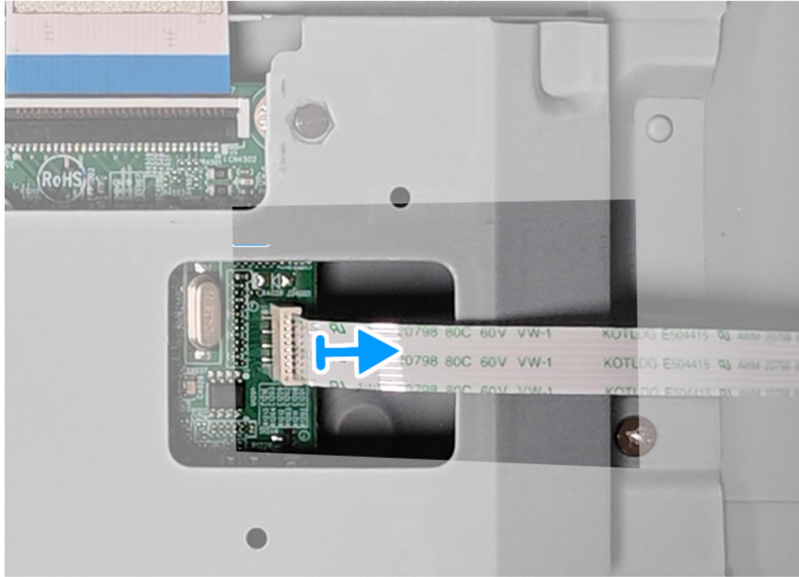
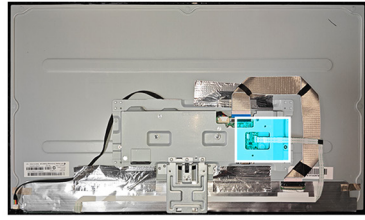

2. Remove three screws (M2x2) on the keypad board.



3x  
M2x2

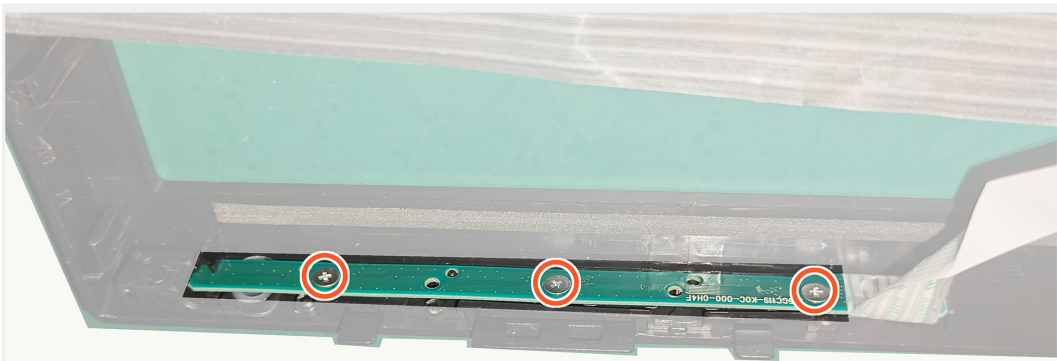



## Installing the keypad board

### Steps

1. Replace three screws (M2x2) to secure the keypad boardr to the monitor.



**3x**  
M2x2

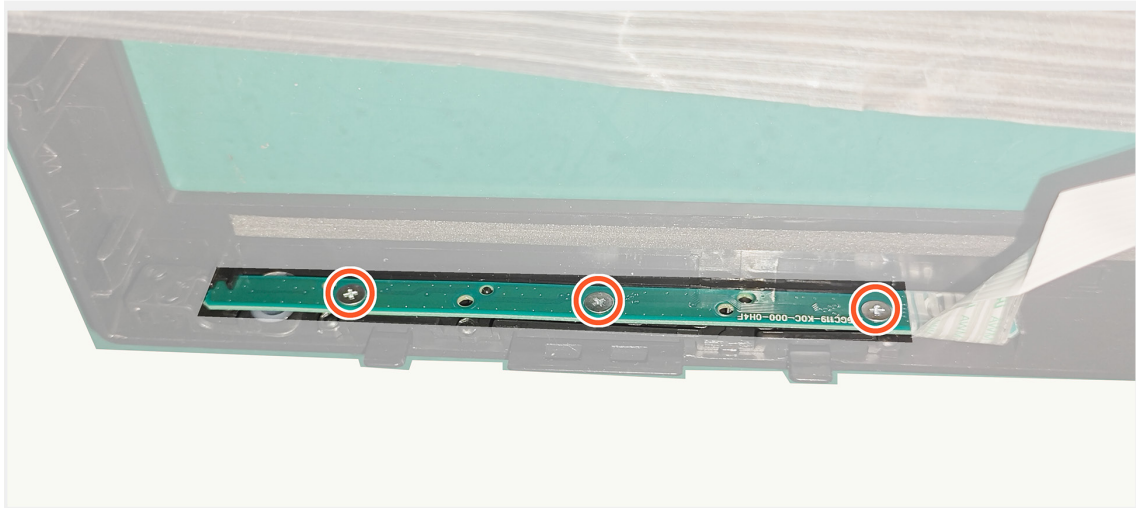

1. Connect keypad board cable to the connector on the main board.

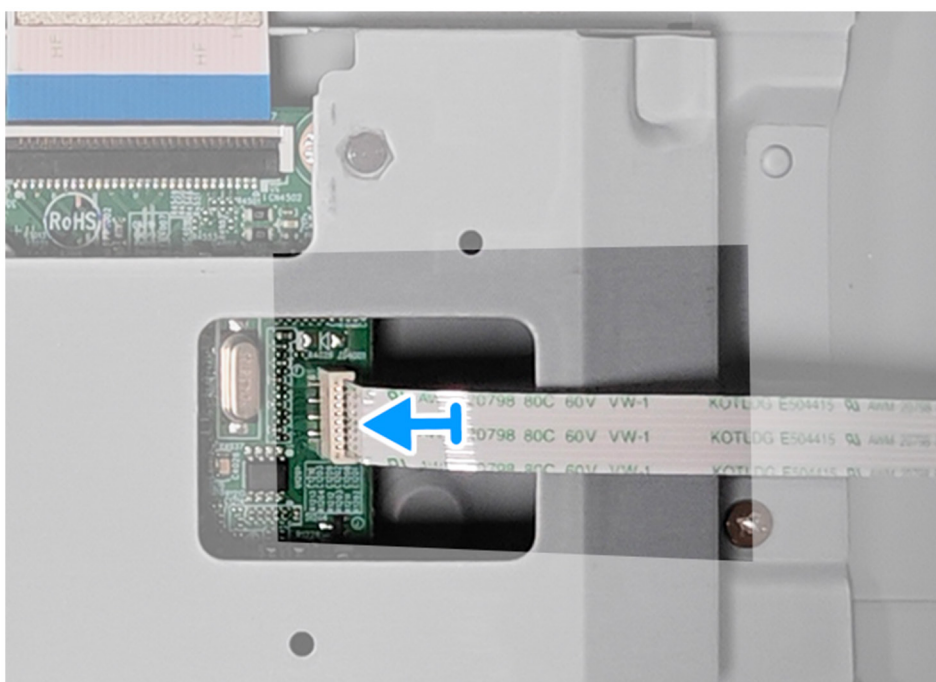
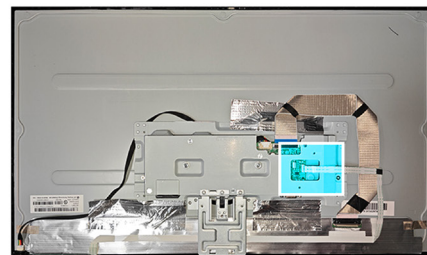

## Next steps

1. [Installing the back cover.](#)
2. Follow the procedure in [After working inside your monitor.](#)

## Metal frame

### Removing the metal frame

#### Prerequisites

1. Follow the procedure in [Before working inside your monitor.](#)
2. [Removing the stand.](#)
3. [Removing the VESA cover.](#)
4. [Removing the back cover.](#)

#### Steps

1. Disconnect three cables on the connector of the panel and main board and remove three tapes on metal frame.

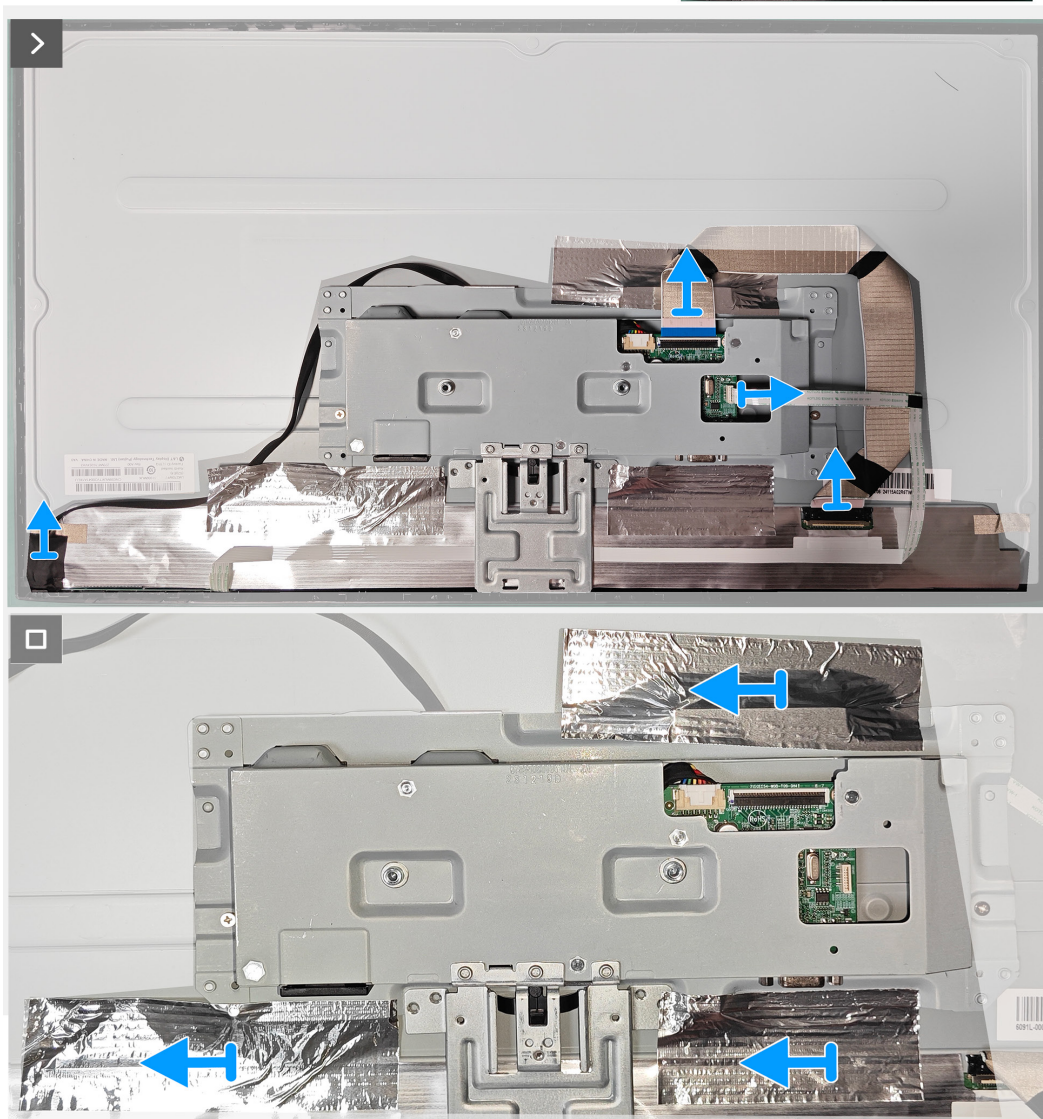
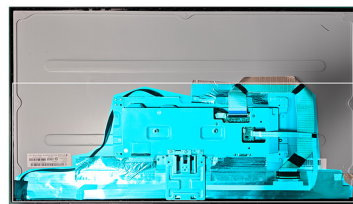

2. Remove two screws (M3x2.5) on the two sides of metal frame.
3. Remove two screws (4-40unc) on the VGA port of metal frame.



2x  
M3x2.5



2x  
4-40unc

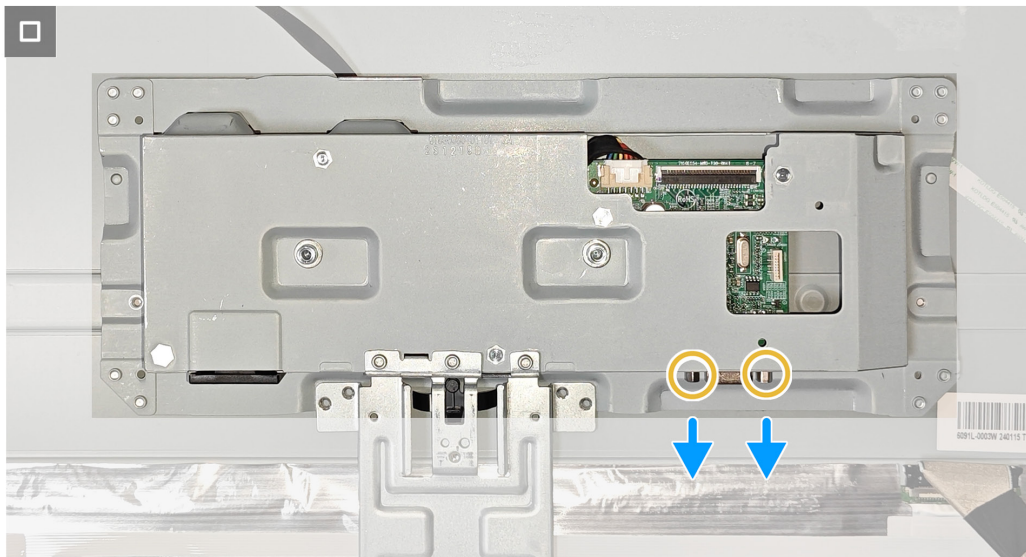
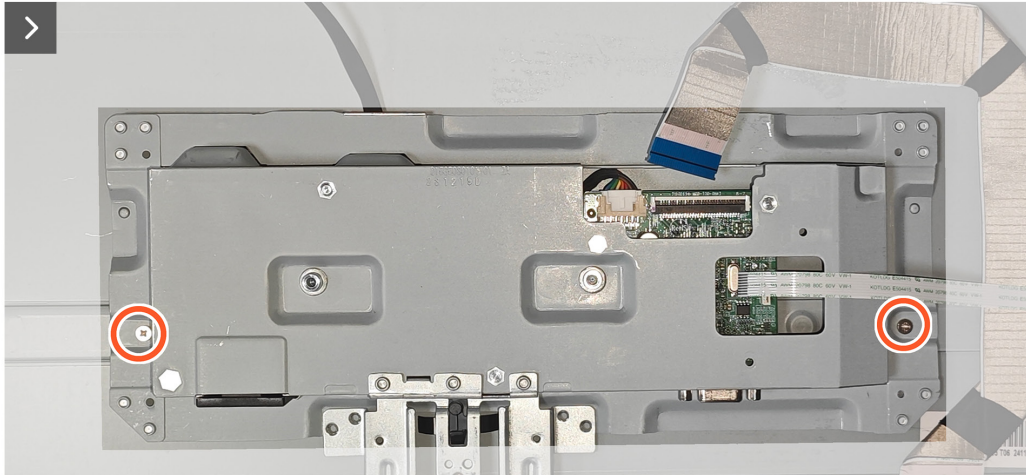
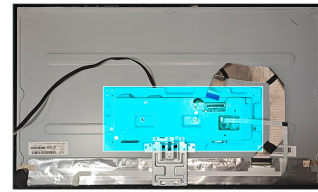

## Installing the metal frame

### Steps

1. Replace two screws (M3x2.5) on the two sides of metal frame.
2. Replace two screws (4-40unc) on the VGA port of metal frame.



2x  
M3x2.5



2x  
4-40unc

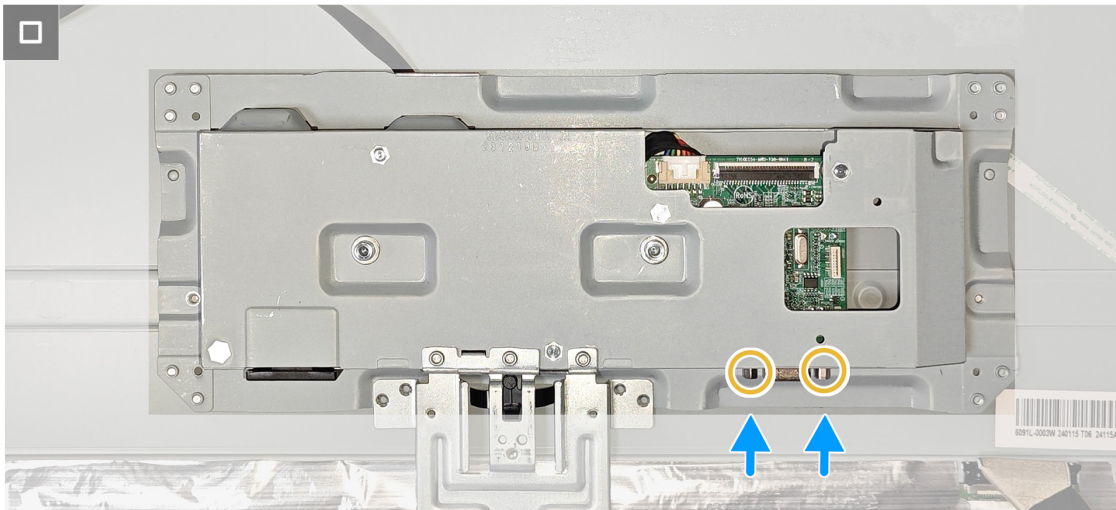
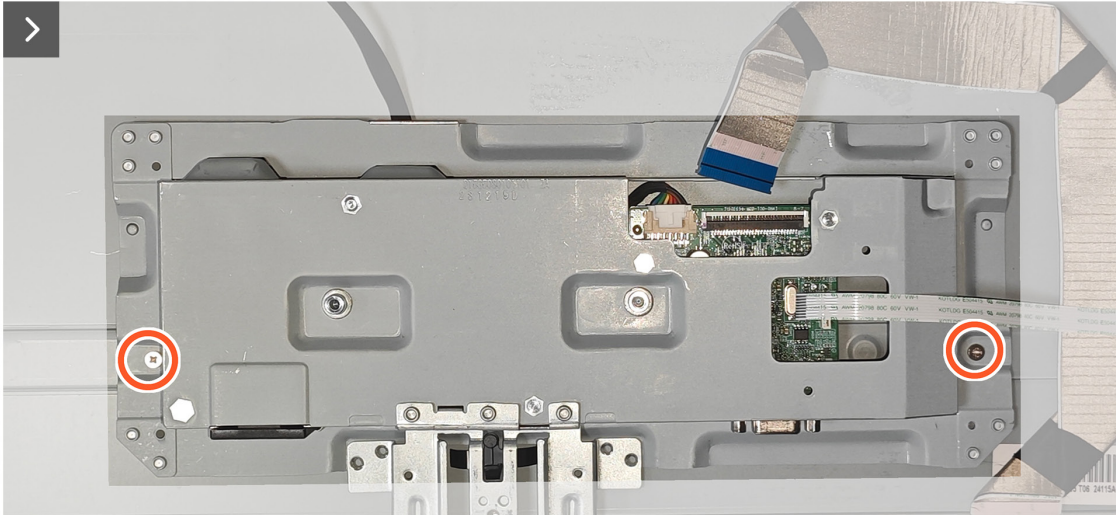
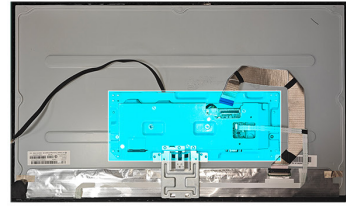

2. Replace three tapes on metal frame and Connect three cables to the connector on the panel and main board.

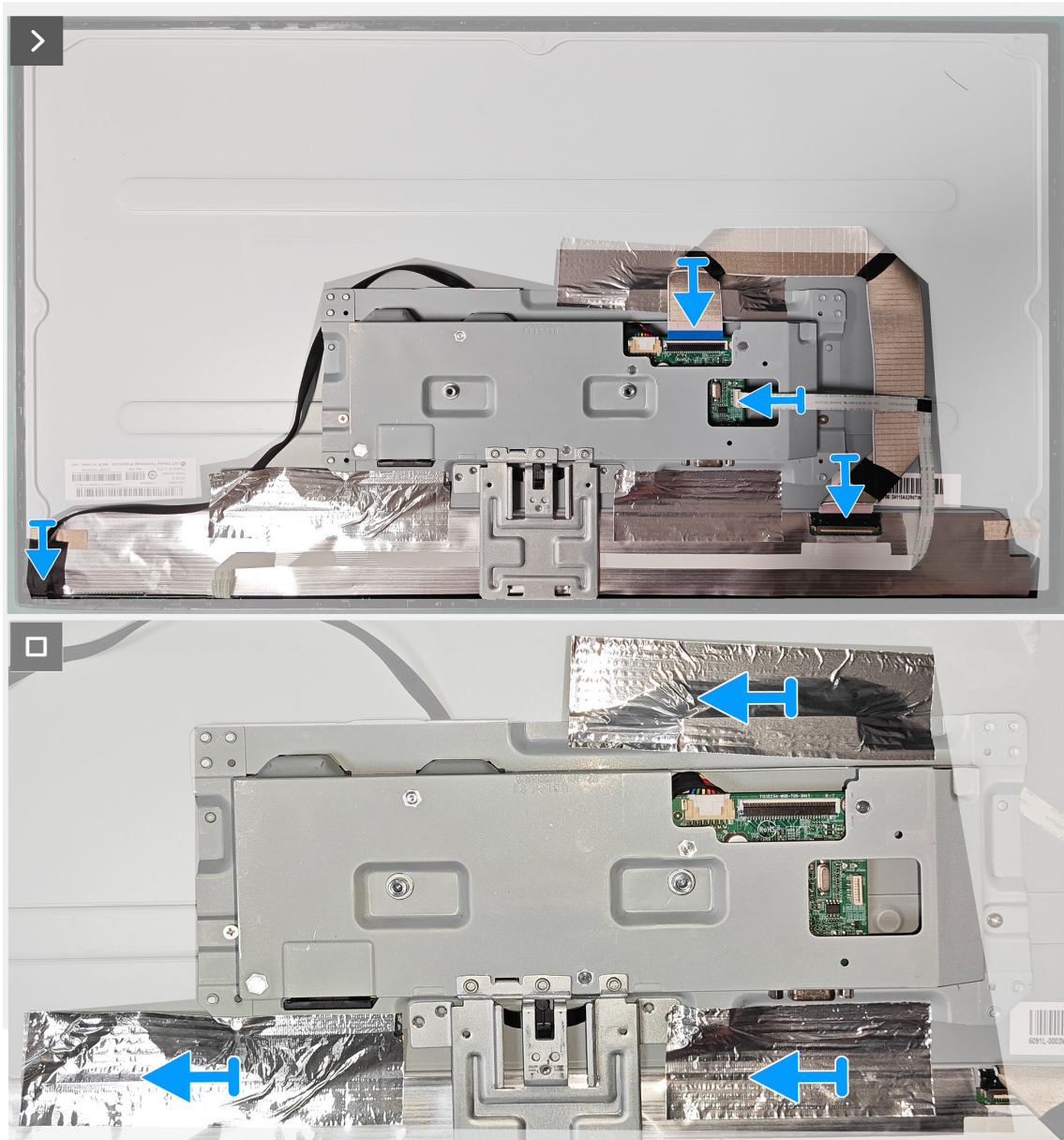
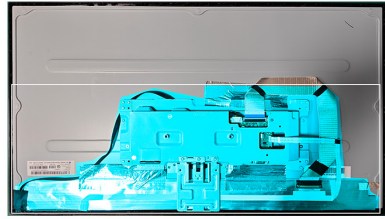

### Next steps

1. [Installing the back cover.](#)
2. Follow the procedure in [After working inside your monitor.](#)

## Main board and power board

### Removing the main board and power board

#### Prerequisites

1. Follow the procedure in [Before working inside your monitor.](#)
2. [Removing the stand.](#)
3. [Removing the VESA cover.](#)

- 4. Removing the back cover.
- 5. Removing the metal frame.

**Steps**

- 1. Remove the mylar on the power board.



- 3. Remove four screws (D3x7) and one screw (M4x8) on the main board and power board.



**4x**  
D3x7



**1x**  
M4x8

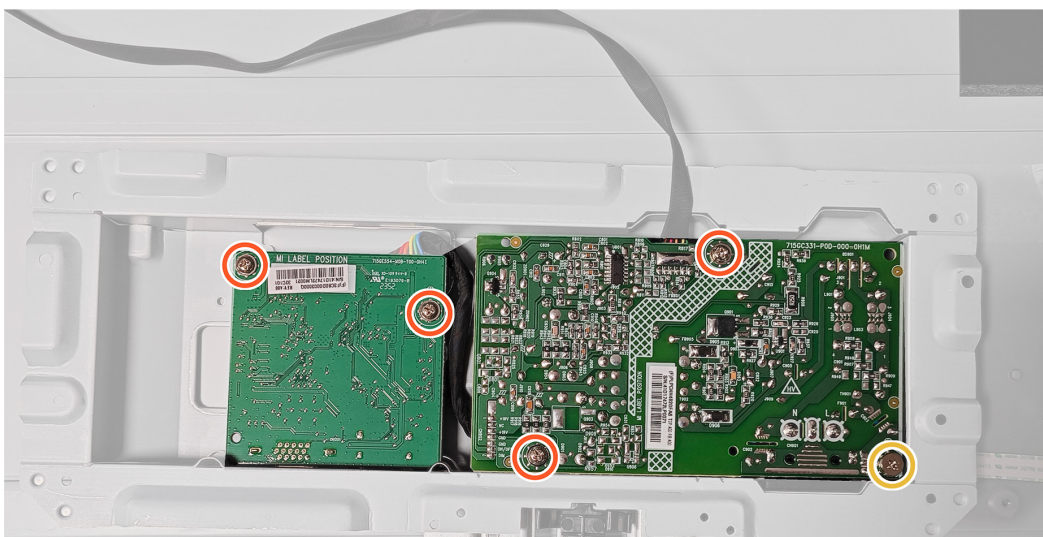
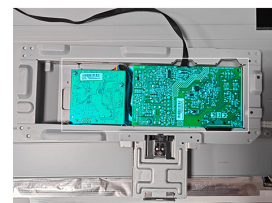

3. Disconnect two cables from the connector on the main board and power board.

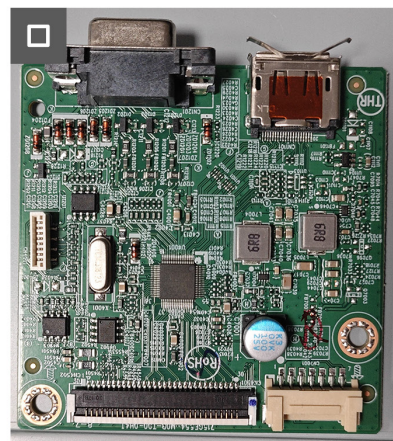
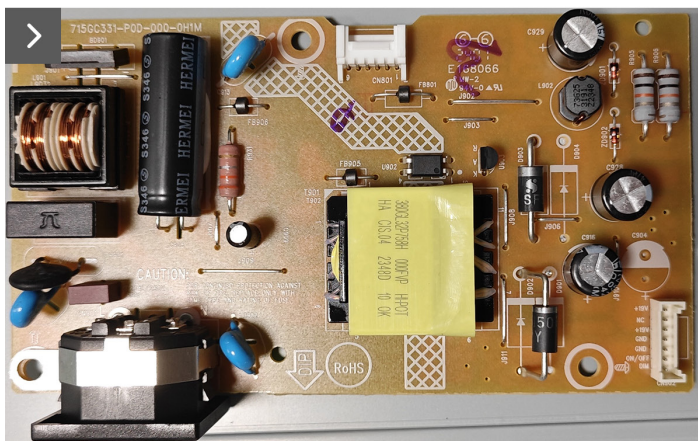
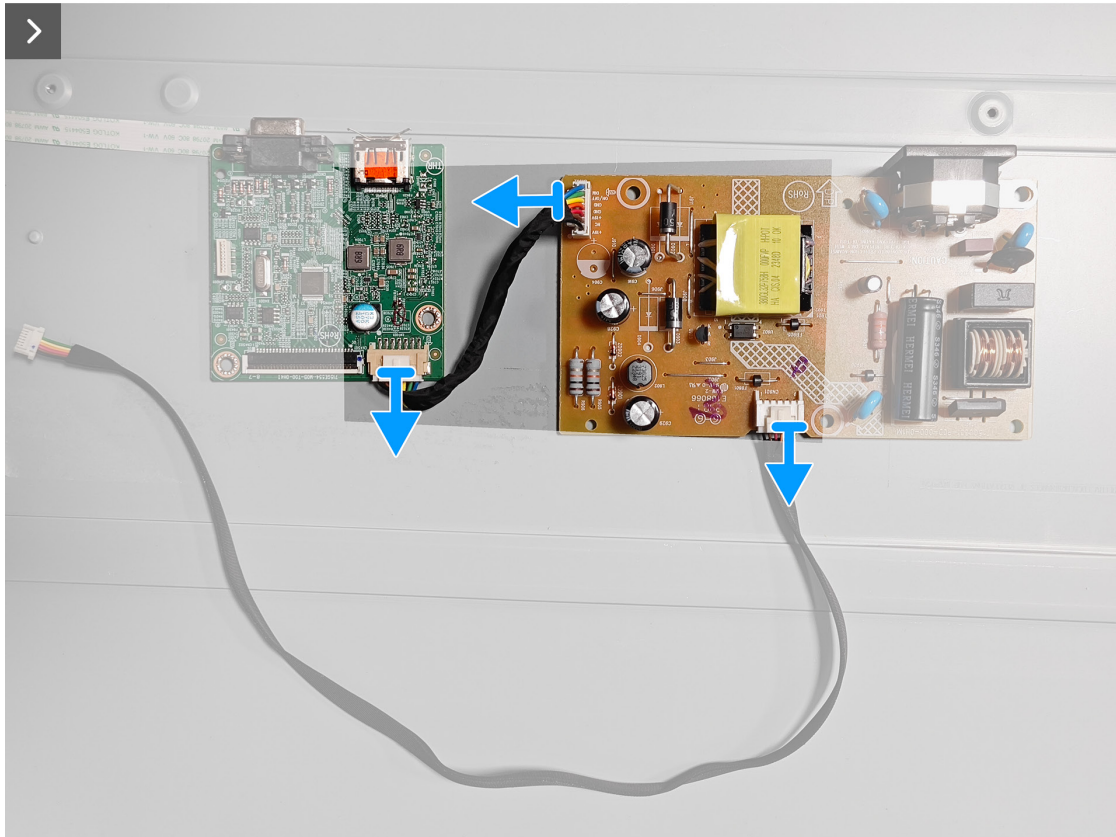
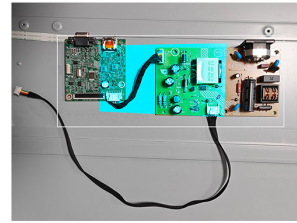

## Installing the main board and power board

### Steps

1. Connect two cables to the connector on the main board and power board.

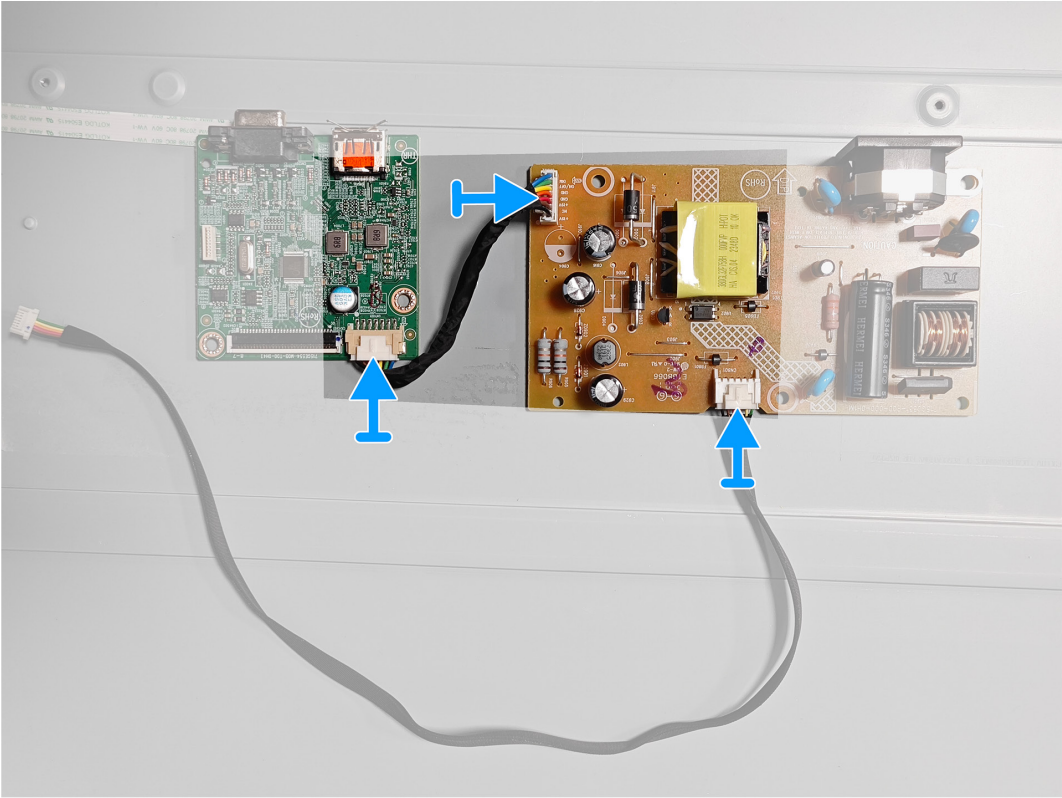
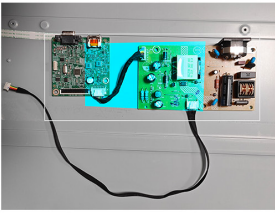

3. Replace four screws (D3x7) and one screw (M4x8) on the main board and power board.

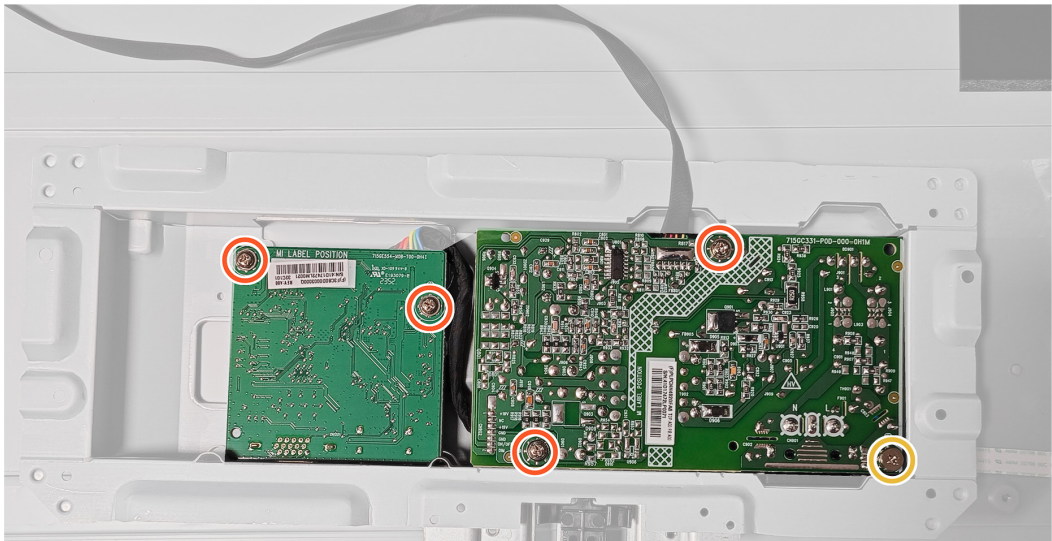
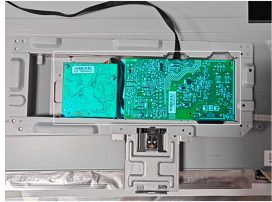



**Next steps**

1. [Installing the metal frame.](#)
2. Follow the procedure in [After working inside your monitor.](#)

# Troubleshooting

**⚠ WARNING:** Before you begin any of the procedures in this section, follow the [Safety instructions](#).

## Self-Test

Your monitor provides a self-test feature that allows you to check if your monitor is functioning properly. If your monitor and computer are properly connected but the monitor screen remains dark, run the monitor self-test by performing the following steps:

1. Turn off both your computer and the monitor.
2. Disconnect all video cables from the monitor. This way, the computer does not have to be involved.
3. Turn on the monitor.

If the monitor is working correctly, it detects that there is no signal and one of the following messages appears. While in self-test mode, the power LED remains white.

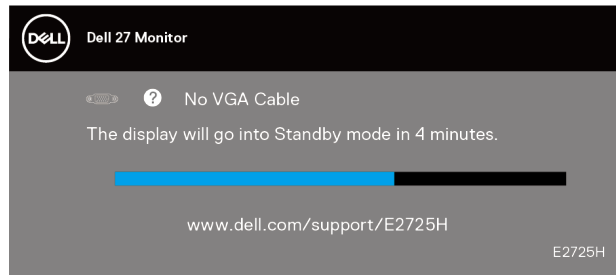

Or

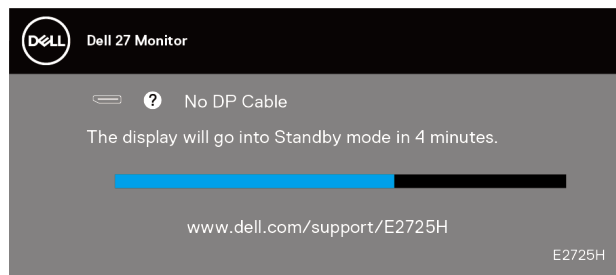

Or

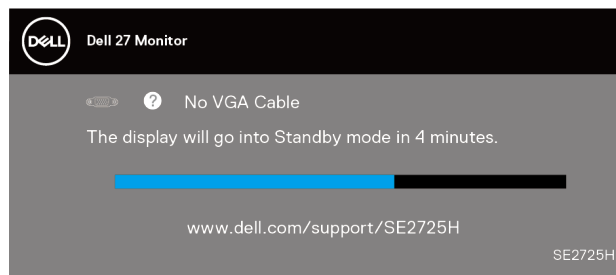

Or

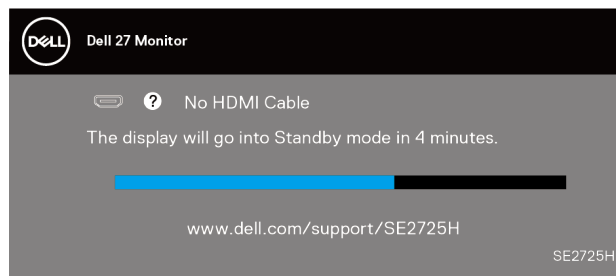

**ⓘ NOTE:** This box also appears on the monitor screen, if the video cable is disconnected or damaged.

4. Turn Off your monitor and reconnect the video cable; then turn on your computer and the monitor.

If your monitor remains dark after you reconnect the cables, check your video controller and computer.

## Onboard diagnostics

Your monitor has an onboard diagnostic tool that helps you determine if any screen abnormality you experience is an inherent problem with your monitor, or with your computer and video card.

**NOTE:** You can run the onboard diagnostics only when the video cable is unplugged and the monitor is in self-test mode.

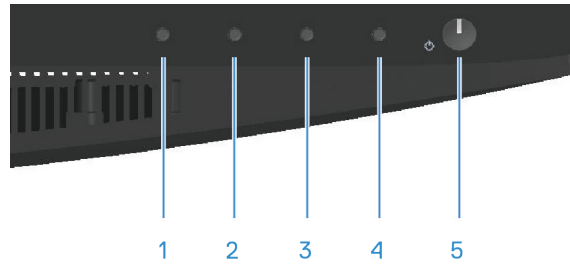

To run the onboard diagnostics:

1. Ensure that the screen is clean (no dust particles on the surface of the screen).
2. Unplug the video cables from the back of the computer or monitor. The monitor then goes into the self-test mode.
3. Press and hold the Exit button (button 4) for four seconds to enter the OSD lock/unlock menu.

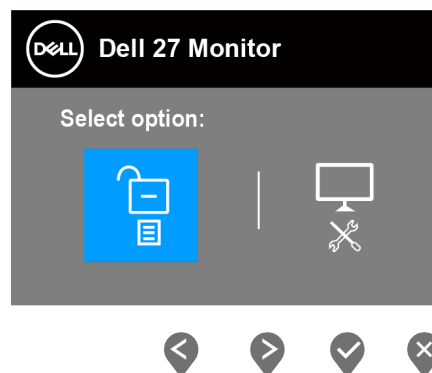
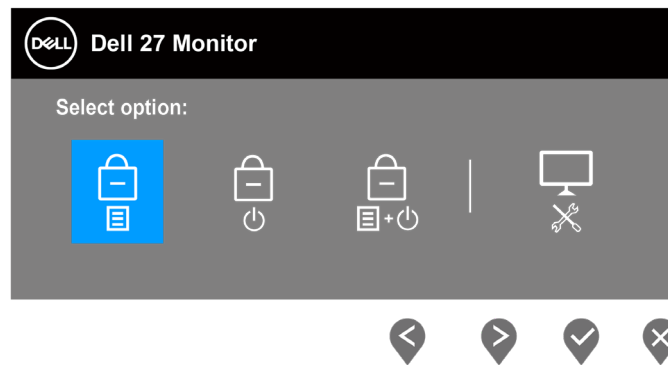

4. Select the  icon to run the onboard diagnostics.
5. Carefully inspect the screen for abnormalities.
6. Press the Up button (button 1) on the back cover again. The color of the screen changes to gray.
7. Inspect the display for any abnormalities.
8. Repeat steps 6 and 7 to inspect the display in red, green, blue, black, white, and text pattern screens.

The test is completed when the text pattern screen appears. To exit, press the Up button (button 1) again.

If you do not detect any screen abnormalities upon using the onboard diagnostic tool, the monitor is functioning properly. Check the video card and computer.

## Common problems

The following table contains general information about common monitor problems that you might encounter and the possible solutions:

**Table 1.** Common problems

Common Symptoms	Possible Solutions
No video/power LED off	<p>Ensure that the video cable connecting the monitor and the computer is properly connected and secure.</p> <p>Verify that the power outlet is functioning properly using any other electrical equipment.</p> <p>Ensure that the power button is pressed.</p> <p>Ensure that the correct input source is selected through the <a href="#">Input Source</a> menu.</p>
No video/power LED on	<p>Increase brightness and contrast controls using the OSD.</p> <p>Perform monitor self-test feature check.</p> <p>Check for bent or broken pins in the video cable connector.</p> <p>Run the onboard diagnostics.</p> <p>Ensure that the correct input source is selected through the <a href="#">Input Source</a> menu.</p>
Poor focus	<p>Eliminate video extension cables.</p> <p>Reset the monitor to factory settings (<b>Factory Reset</b>).</p> <p>Change the video resolution to the correct aspect ratio.</p>
Shaky or jittery video	<p>Reset the monitor to factory settings (<b>Factory Reset</b>).</p> <p>Check environmental factors.</p> <p>Relocate the monitor and test in another room.</p>
Missing pixels	<p>Cycle power On-Off.</p> <p>A pixel that is permanently Off is a natural defect that can occur in LCD technology.</p> <p>For more information about Dell Monitor Quality and Pixel Policy, see Dell Support site at: <a href="http://www.dell.com/pixelguidelines">www.dell.com/pixelguidelines</a>.</p>
Stuck-on pixels	<p>Cycle power On-Off.</p> <p>A pixel that is permanently off is a natural defect that can occur in LCD technology.</p> <p>For more information about Dell Monitor Quality and Pixel Policy, see Dell Support site at: <a href="http://www.dell.com/pixelguidelines">www.dell.com/pixelguidelines</a>.</p>
Brightness problems	<p>Reset the monitor to factory settings (<b>Factory Reset</b>).</p> <p>Adjust brightness and contrast controls through OSD.</p>
Geometric distortion	<p>Reset the monitor to factory settings (<b>Factory Reset</b>).</p> <p>Adjust horizontal and vertical controls through OSD.</p>
Horizontal or vertical lines	<p>Reset the monitor to factory settings (<b>Factory Reset</b>).</p> <p>Perform monitor self-test feature check and determine if these lines are also in self-test mode.</p> <p>Check for bent or broken pins in the video cable connector.</p> <p>Run the onboard diagnostics.</p>
Synchronization problems	<p>Reset the monitor to factory settings (<b>Factory Reset</b>).</p> <p>Perform a monitor self-test feature check to determine if the scrambled screen appears in self-test mode.</p> <p>Check for bent or broken pins in the video cable connector.</p> <p>Restart the computer in the safe mode.</p>
Safety-related issues	<p>Do not perform any troubleshooting steps.</p> <p>Contact Dell immediately.</p>

Common Symptoms	Possible Solutions
Intermittent problems	<p>Ensure that the video cable connecting the monitor to the computer is connected properly and is secure.</p> <p>Reset the monitor to factory settings (<b>Factory Reset</b>).</p> <p>Perform a monitor self-test feature check to determine if the intermittent problem occurs in self-test mode.</p>
Missing color	<p>Perform a monitor self-test feature check.</p> <p>Ensure that the video cable connecting the monitor to the computer is connected properly and is secure.</p> <p>Check for bent or broken pins in the video cable connector.</p>
Wrong color	<p>Try different <b>Preset Modes</b> in <b>Color</b> settings OSD. Adjust <b>R/G/B</b> value in <b>Custom Color</b> in <b>Color</b> settings OSD.</p> <p>Change the <b>Input Color Format</b> to <b>RGB</b> or <b>YCbCr/YPbPr</b> in the <b>Color settings</b> OSD.</p> <p>Run the onboard diagnostics.</p>
Image retention from a static image left on the monitor for a long time	<p>Set the screen to turn off after a few minutes of screen idle time. These can be adjusted in the Windows Power Options or Mac Energy Saver setting.</p> <p>Alternatively, use a dynamically changing screensaver.</p>
Video ghosting or overshooting	<p>Change the <b>Response Time</b> in the <b>Display</b> OSD to <b>Normal</b> or <b>Fast</b> depending on your application and usage.</p>

## Product-specific problems

**Table 2.** Product-specific problems

Specific Symptoms	Possible Solutions
The screen image is too small	<p>Check the <b>Aspect Ratio</b> setting in the <b>Display</b> settings OSD.</p> <p>Reset the monitor to factory settings (<b>Factory Reset</b>).</p>
Cannot adjust the monitor with the buttons on the bottom of the panel	<p>Turn Off the monitor, unplug the power cable, plug it back, and then turn On the monitor.</p> <p>Check if the OSD menu is locked. If yes, press and hold the Exit button (button 4) for four seconds to unlock.</p>
No Input Signal when user controls are pressed	<p>Check the signal source. Ensure that the computer is not in Standby Mode by moving the mouse or pressing any key on the keyboard.</p> <p>Check if the video cable is plugged in properly. Disconnect and reconnect the video cable if necessary.</p> <p>Reset the computer or video player.</p>
The picture does not fill the entire screen	<p>Due to different video formats (aspect ratio) of DVDs, the monitor may display in full screen.</p> <p>Run the onboard diagnostics.</p>

# Contacting Dell

To contact Dell for sales, technical support, or customer service issues, see [www.dell.com/contactdell](http://www.dell.com/contactdell).

- ① **NOTE:** Availability varies by country, region, or product, and some services may not be available in your country.
- ① **NOTE:** If you do not have an active Internet connection, you can find contact information about your purchase invoice, packing slip, bill, or Dell product catalog.