

Quick Start Guide

RT-BE88U
BE7200 Dual Band Wi-Fi Router

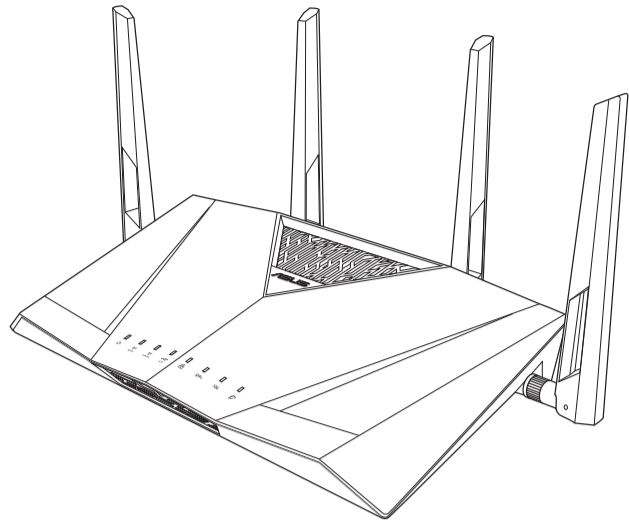

Hardware Explanations

I/O Ports Overview

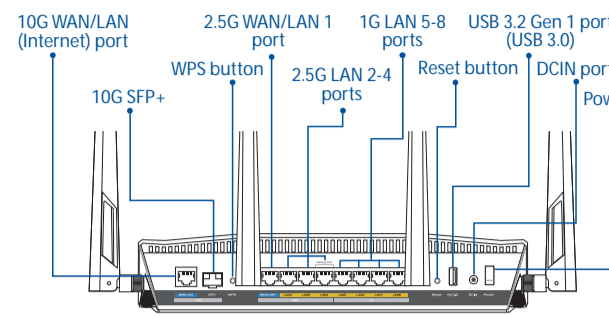

LED Lights Overview

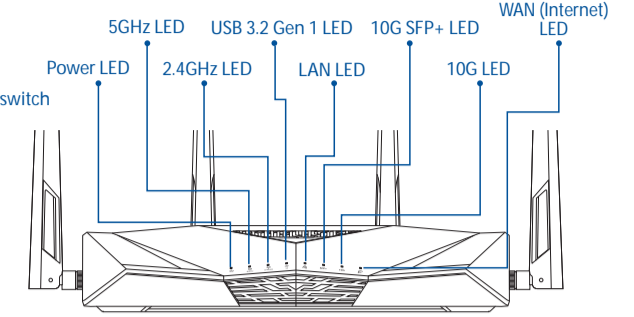

Specifications:

DC Power adapter	DC Output: +19.5V with 2.31A current	
	DC Output: +12V with 5A current	
Operating Temperature	0~40°C	Storage 0~70°C
Operating Humidity	50~90%	Storage 20~90%

Router Setup Steps

01 Prepare your Modem

- 1 Unplug the power of cable / DSL modem. If it has a battery backup, remove the battery.
- 2 Connect your modem to WAN port at the back side of the router with the network cable provided.
- 3 Power on the modem. Plug modem to the power outlet and power on.
- 4 Check the modem LED lights to ensure the connection is active.

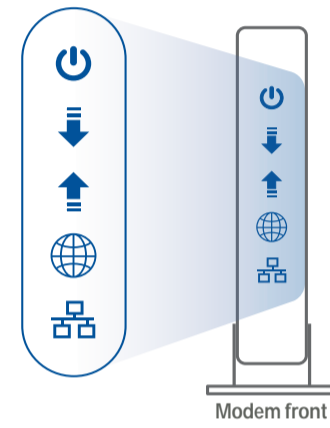
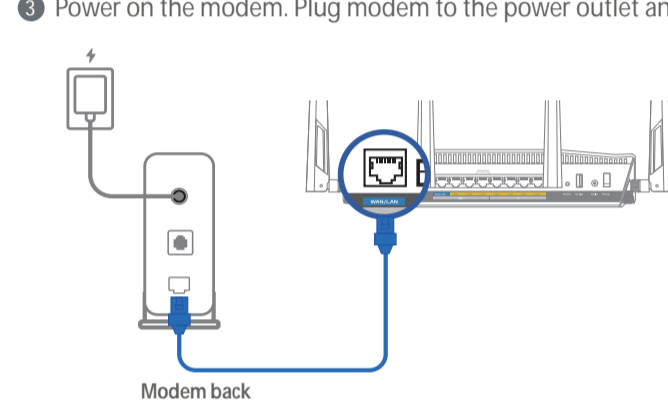
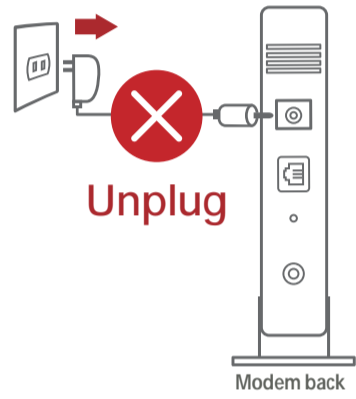

If you are using DSL for internet, you will need your username / password from your Internet service provider (ISP) to properly configure your router.

02 Install your Router

- 1 Plug the adapter into the DCIN port, and press the Power switch.
- 2 The power LED will light up when the hardware is ready.

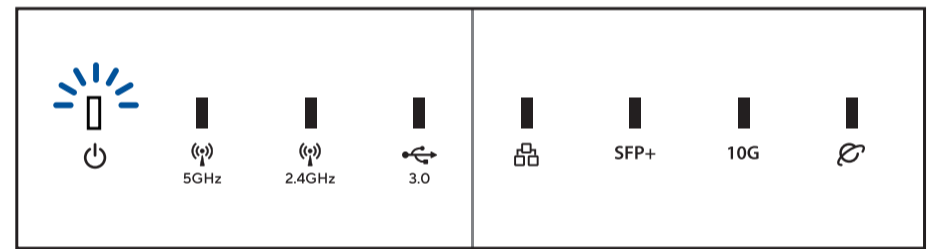
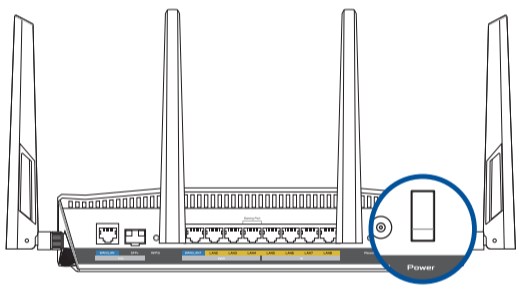

- Via app

- 3 [App] On your iOS or Android mobile device, go to the app store, search for **ASUS Router**, and download the app.
- 4 [App] On your iOS or Android mobile device, tap **Settings > Wi-Fi**, connect to the default network SSID shown on the product label on the back side of the router. Or scan the QR code on the product label to connect the default network SSID.
- 5 [App] Launch **ASUS Router App** and follow the instructions to complete the setup.

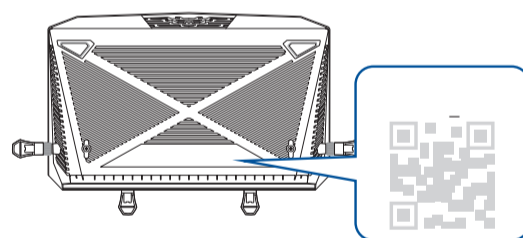
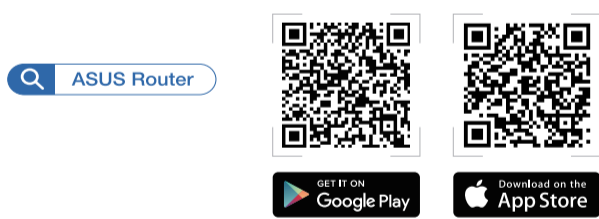

*XX refers to the last two digits of MAC address. You can find it on the label on the back of your router.

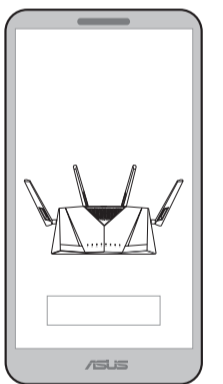

- Or via web browser

- 3 [Wired] Connect your PC to LAN port at the back side of the router using an additional network cable.
- 4 [Wired / Wireless] Open a web browser.

[Wireless] Connect to the network with default SSID shown on the product label on the back side of your router "ASUS_XX".

You will be redirected to the ASUS Setup Wizard. If not, navigate to <http://www.asusrouter.com>. Follow the instructions to complete the setup.

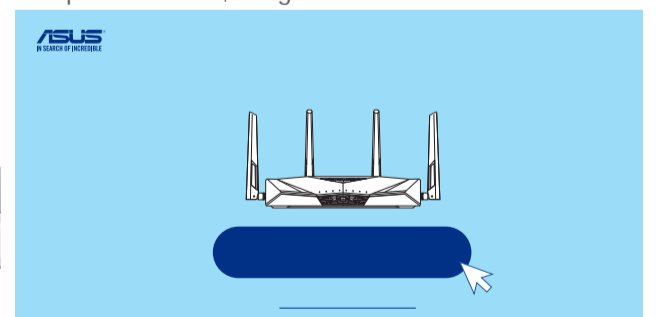
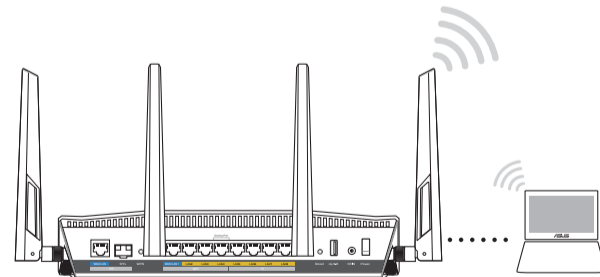
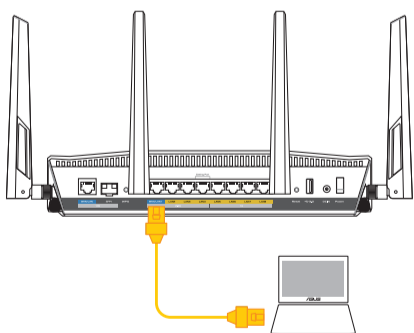

Gain Another 10GE LAN Port

01 Set up 2.5GE WAN connection to release another 10GE LAN Port

- Under factory defaults

Connect to the 2.5GE WAN port

Connect the modem to the 2.5GE WAN port with a network cable.

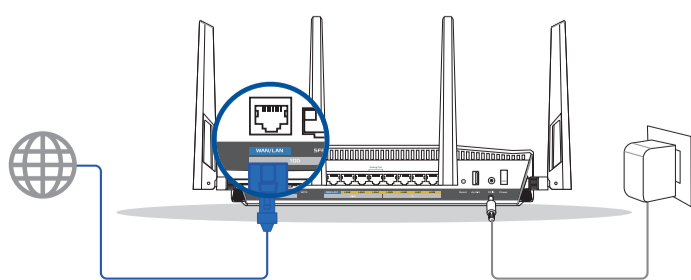

Login and Connect

- 1 [ASUS Setup Wizard] Select "Manual Setting".
- 2 [ASUS Setup Wizard] Select "2.5G WAN", then follow the instructions to complete the setup of SSID and login information.

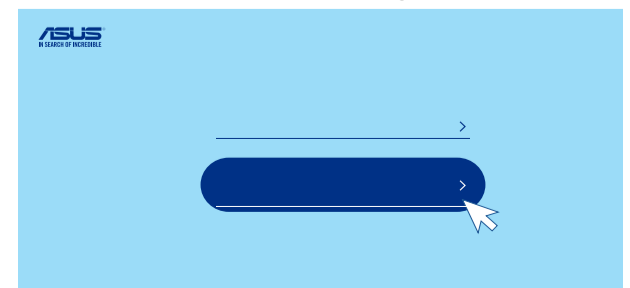
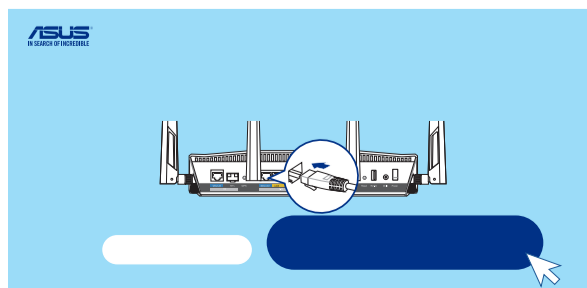

02 Start to Use

- After following the setup steps, the router will reboot for a second and start to connect the Internet with 2.5GE port.

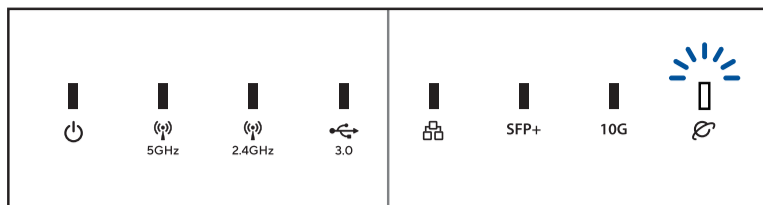

FAQ FREQUENTLY ASKED QUESTIONS

Q1: Where can I find more information about the wireless router?
Technical support site: <https://www.asus.com/support>

Service and Support



<https://www.asus.com/support>

Video Tutorials



https://qr.asus.com/wi_videotutorials

ASUS Recycling/Takeback Services

ASUS recycling and takeback programs come from our commitment to the highest standards for protecting our environment. We believe in providing solutions for you to be able to responsibly recycle our products, batteries, other components, as well as the packaging materials. Please go to <http://csr.asus.com/english/Takeback.htm> for the detailed recycling information in different regions.

REACH

Complying with the REACH (Registration, Evaluation, Authorisation, and Restriction of Chemicals) regulatory framework, we published the chemical substances in our products at ASUS REACH website at <http://csr.asus.com/english/REACH.htm>

Federal Communications Commission Statement

This device complies with Part 15 of the FCC Rules. Operation is subject to the following two conditions:

- This device may not cause harmful interference.
- This device must accept any interference received, including interference that may cause undesired operation.

This equipment has been tested and found to comply with the limits for a class B digital device, pursuant to part 15 of the FCC Rules. These limits are designed to provide reasonable protection against harmful interference in a residential installation.

This equipment generates, uses and can radiate radio frequency energy and, if not installed and used in accordance with the instructions, may cause harmful interference to radio communications. However, there is no guarantee that interference will not occur in a particular installation. If this equipment does cause harmful interference to radio or television reception, which can be determined by turning the equipment on and off, the user is encouraged to try to correct the interference by one or more of the following measures:

- Reorient or relocate the receiving antenna.
- Increase the separation between the equipment and receiver.
- Connect the equipment into an outlet on a circuit different from that to which the receiver is connected.
- Consult the dealer or an experienced radio/TV technician for help.



WARNING! Any changes or modifications not expressly approved by the party responsible for compliance could void the user's authority to operate the equipment.

Prohibition of Co-location

This device and its antenna(s) must not be co-located or operating in conjunction with any other antenna or transmitter.

IMPORTANT NOTE:

Radiation Exposure Statement: This equipment complies with FCC radiation exposure limits set forth for an uncontrolled environment. End users must follow the specific operating instructions for satisfying RF exposure compliance. To maintain compliance with FCC exposure compliance requirement, please follow operation instruction as documented in this manual.



WARNING! This equipment must be installed and operated in accordance with provided instructions and the antenna(s) used for this transmitter must be installed to provide a separation distance of at least 51cm from all persons and must not be co-located or operating in conjunction with any other antenna or transmitter.

This device is restricted for indoor use.

Compliance Statement of Innovation, Science and Economic Development Canada (ISED)

This device complies with Innovation, Science and Economic Development Canada licence exempt RSS standard(s). Operation is subject to the following two conditions: (1) this device may not cause interference, and (2) this device must accept any interference, including interference that may cause undesired operation of the device.

Operation in the band 5150–5250 MHz is only for indoor use to reduce the potential for harmful interference to co-channel mobile satellite systems.

CAN ICES-003(B)/NMB-003(B)

Radio Frequency (RF) Exposure Information

The radiated output power of the ASUS Wireless Device is below the Innovation, Science and Economic Development Canada radio frequency exposure limits. The ASUS Wireless Device should be used in such a manner such that the potential for human contact during normal operation is minimized.

This equipment should be installed and operated with a minimum distance of 31cm between the radiator any part of your body.

This device has been certified for use in Canada. Status of the listing in the Innovation, Science and Economic Development Canada's REL (Radio Equipment List) can be found at the following web address:

http://www.ic.gc.ca/eic/site/ceb-bhst.nsf/eng/h_tt00020.html

Additional Canadian information on RF exposure also can be found at the following web:

<https://www.ic.gc.ca/eic/site/smt-gst.nsf/eng/sf08792.html>

Déclaration de conformité de Innovation, Sciences et Développement économique Canada (ISED)

Le présent appareil est conforme aux CNR d'Innovation, Sciences et Développement économique Canada applicables aux appareils radio exempts de licence. L'exploitation est autorisée aux deux conditions suivantes : (1) l'appareil ne doit pas produire de brouillage, et (2) l'utilisateur de l'appareil doit accepter tout brouillage radioélectrique subi, même si le brouillage est susceptible d'en compromettre le fonctionnement.

La bande 5150 – 5250 MHz est réservée uniquement pour une utilisation à l'intérieur afin de réduire les risques de brouillage préjudiciable aux systèmes de satellites mobiles utilisant les mêmes canaux.

CAN ICES-003(B)/NMB-003(B)

Informations concernant l'exposition aux fréquences radio (RF)

La puissance de sortie émise par cet appareil sans fil est inférieure à la limite d'exposition aux fréquences radio d'Innovation, Sciences et Développement économique du Canada (ISED). Utilisez l'appareil sans fil de façon à minimiser les contacts humains lors d'un fonctionnement normal.

Cet équipement doit être installé et utilisé avec un minimum de 31cm de distance entre la source de rayonnement et votre corps.

L'utilisation de cet appareil est autorisée au Canada. Pour consulter l'entrée correspondant à l'appareil dans la liste d'équipement radio (REL - Radio Equipment List) d'Innovation, Sciences et Développement économique du Canada, rendez-vous sur : http://www.ic.gc.ca/eic/site/ceb-bhst.nsf/eng/h_tt00020.html

Pour des informations supplémentaires concernant l'exposition aux fréquences radio au Canada, rendez-vous sur: <https://www.ic.gc.ca/eic/site/smt-gst.nsf/eng/sf08792.html>

For indoor use only.

Pour une utilisation en intérieur uniquement.

This radio transmitter [3568A-RTBE7000] has been approved by Innovation, Science and Economic Development Canada to operate with the antenna types listed below, with the maximum permissible gain indicated. Antenna types not included in this list that have a gain greater than the maximum gain indicated for any type listed are strictly prohibited for use with this device.

Le présent émetteur radio (3568A-RTBE7000) a été approuvé par Innovation, Sciences et Développement économique Canada pour fonctionner avec les types d'antenne énumérés ci-dessous et ayant un gain admissible maximal d'antenne. Les types d'antennes non inclus dans cette liste qui ont un gain supérieur au gain maximal indiqué pour tout type listé sont strictement interdits pour une utilisation avec cet appareil.

Set	Ant.	Brand Name	Model Name	Antenna Type	2.4GHz	5GHz			
						UNII 1	UNII 2A	UNII 2C	UNII 3
1	ANT0	M.gear	C660-510411-A	Dipole	1.43	1.47	1.47	1.49	1.08
	ANT1	M.gear	C660-510411-A	Dipole	1.53	1.6	1.6	1.62	1.21
	ANT2	M.gear	C660-510411-A	Dipole	1.33	1.21	1.21	1.23	0.82
	ANT3	M.gear	C660-510411-A	Dipole	1.25	1.13	1.13	1.15	0.74
2	ANT0	PSA	RFDPA171300SBLB820	Dipole	1.34	1.38	1.38	1.46	1
	ANT1	PSA	RFDPA171300SBLB820	Dipole	1.44	1.51	1.51	1.59	1.13
	ANT2	PSA	RFDPA171300SBLB820	Dipole	1.24	1.12	1.12	1.2	0.74
	ANT3	PSA	RFDPA171300SBLB820	Dipole	1.16	1.04	1.04	1.12	0.66

The maximum antenna gain permitted for devices in the bands 5250-5350 MHz and 5470-5725 MHz shall be such that the equipment still complies with the e.i.r.p. limit.

le gain maximal d'antenne permis pour les dispositifs utilisant les bandes 5250-5350 MHz et 5470-5725 MHz doit se conformer à la limite de p.i.r.e.

The maximum antenna gain permitted for devices in the band 5725-5850 MHz shall be such that the equipment still complies with the e.i.r.p. limits specified for point-to-point and non-point-to-point operation as appropriate.

le gain maximal d'antenne permis (pour les dispositifs utilisant la bande 5725-5850 MHz) doit se conformer à la limite de p.i.r.e. spécifiée pour l'exploitation point à point et non point à point, selon le cas.

Safety Notices

- Use this product in environments with ambient temperatures between 0°C(32°F) and 40°C(104°F).
- Refer to the rating label on the bottom of your product and ensure your power adapter complies with this rating.
- DO NOT place on uneven or unstable work surfaces. Seek servicing if the casing has been damaged.
- DO NOT place or drop objects on top and do not shove any foreign objects into the product.
- DO NOT expose to or use near liquids, rain, or moisture. DO NOT use the modem during electrical storms.
- DO NOT cover the vents on the product to prevent the system from getting overheated.
- DO NOT use damaged power cords, accessories, or other peripherals.
- If the Adapter is broken, do not try to fix it by yourself. Contact a qualified service technician or your retailer.
- To prevent electrical shock hazard, disconnect the power cable from the electrical outlet before relocating the system.
- DO NOT mount this equipment higher than 2 meters.
- The power supply cord(s) must be plugged into socket-outlet(s) that is / are provided with a suitable earth ground.

Avvertissements de sécurité

- Utilisez ce produit dans un environnement dont la température ambiante est comprise entre 0 °C (32 °F) et 40 °C (104 °F).
- Référez-vous à l'étiquette située au dessous du produit pour vérifier que l'adaptateur secteur répond aux exigences de tension.
- NE PAS placer sur une surface irrégulière ou instable. Contactez le service après-vente si le châssis a été endommagé.
- NE PAS placer, faire tomber ou insérer d'objets sur/dans le produit.
- NE PAS exposer l'appareil à la pluie ou à l'humidité, tenez-le à distance des liquides. NE PAS utiliser le modem lors d'un orage.
- NE PAS bloquer les ouvertures destinées à la ventilation du système pour éviter que celui-ci ne surchauffe.
- NE PAS utiliser de cordons d'alimentation, d'accessoires ou autres périphériques endommagés.
- Si l'adaptateur est endommagé, n'essayez pas de le réparer vous-même. Contactez un technicien électrique qualifié ou votre revendeur.
- Pour éviter tout risque de choc électrique, débranchez le câble d'alimentation de la prise électrique avant de toucher au système.
- Ne placez pas cet appareil à une hauteur supérieure à 2 mètres.
- Les cordons d'alimentation doivent être branchés sur une prise électrique correctement reliée à la terre.

Información de seguridad

- Use este producto en entornos sometidos a una temperatura ambiente comprendida entre 0 °C (32 °F) y 40 °C (104 °F).
- Consulte la etiqueta de valores nominales situada en la parte inferior del producto y asegúrese de que su adaptador de alimentación cumple con dichos valores.
- NO coloque el equipo sobre una superficie irregular o inestable. Solicite asistencia técnica si la carcasa resulta dañada.
- NO coloque ni deje caer objetos en la parte superior del producto y no introduzca objetos extraños dentro de él.
- NO exponga el equipo a líquidos, lluvia o humedad, ni lo use cerca de ninguno de tales elementos. NO use el módem durante tormentas eléctricas.
- Para evitar que el sistema se sobrecaliente, no cubra las ranuras de ventilación del producto.
- NO cubra los orificios de ventilación del equipo de sobremesa para evitar que el sistema se caliente en exceso.
- No intente reparar la fuente de alimentación personalmente si se avería. Póngase en contacto con un técnico de mantenimiento autorizado o con su distribuidor.
- A fin de evitar posibles descargas eléctricas, desconecte el cable de alimentación de la toma de suministro eléctrico antes de cambiar la posición del sistema.
- NO monte este equipo a una altura superior a 2 metros.
- Los cables de alimentación se deben enchufar a tomas de corriente que estén provistas de una conexión a tierra adecuada.

Informações de segurança

- Utilize este equipamento em ambientes com temperaturas entre 0°C (32°F) e 40°C (104°F).
- Verifique a etiqueta relativa à tensão na parte inferior do seu dispositivo e assegure-se de que o seu transformador corresponde a essa tensão.
- NÃO coloque o computador em superfícies irregulares ou instáveis. Envie para reparação se a caixa se encontrar danificada.
- NÃO coloque nem deixe cair objetos em cima do aparelho e não introduza quaisquer objetos estranhos no produto.
- NÃO exponha o equipamento nem o utilize próximo de líquidos, chuva ou humidade. NÃO utilize o modem durante tempestades elétricas.
- NÃO tape os orifícios de ventilação do produto para impedir o sobreaquecimento do sistema.
- NÃO utilize cabos de alimentação, acessórios ou outros periféricos danificados.
- Se a fonte de alimentação estiver avariada, não tente repará-la por si próprio. Contacte um técnico qualificado ou o seu revendedor.
- Para evitar o risco de choque eléctrico, desligue o cabo de alimentação da tomada eléctrica antes de deslocar o sistema.
- NÃO instale este equipamento a uma altura superior a 2 metros.
- O(s) cabo(s) de alimentação deve(m) ser ligado(s) a tomadas elétricas com ligação à terra adequada.