

HDMI™
HIGH-DEFINITION MULTIMEDIA INTERFACE



E23022

Revised Edition V5 / December 2023

IN SEARCH OF INCREDIBLE

E-Manual

ASUS

COPYRIGHT INFORMATION

No part of this manual, including the products and software described in it, may be reproduced, transmitted, transcribed, stored in a retrieval system, or translated into any language in any form or by any means, except documentation kept by the purchaser for backup purposes, without the express written permission of ASUSTeK COMPUTER INC. ("ASUS").

ASUS PROVIDES THIS MANUAL "AS IS" WITHOUT WARRANTY OF ANY KIND, EITHER EXPRESS OR IMPLIED, INCLUDING BUT NOT LIMITED TO THE IMPLIED WARRANTIES OR CONDITIONS OF MERCHANTABILITY OR FITNESS FOR A PARTICULAR PURPOSE. IN NO EVENT SHALL ASUS, ITS DIRECTORS, OFFICERS, EMPLOYEES OR AGENTS BE LIABLE FOR ANY INDIRECT, SPECIAL, INCIDENTAL, OR CONSEQUENTIAL DAMAGES (INCLUDING DAMAGES FOR LOSS OF PROFITS, LOSS OF BUSINESS, LOSS OF USE OR DATA, INTERRUPTION OF BUSINESS AND THE LIKE), EVEN IF ASUS HAS BEEN ADVISED OF THE POSSIBILITY OF SUCH DAMAGES ARISING FROM ANY DEFECT OR ERROR IN THIS MANUAL OR PRODUCT.

Products and corporate names appearing in this manual may or may not be registered trademarks or copyrights of their respective companies, and are used only for identification or explanation and to the owners' benefit, without intent to infringe.

SPECIFICATIONS AND INFORMATION CONTAINED IN THIS MANUAL ARE FURNISHED FOR INFORMATIONAL USE ONLY, AND ARE SUBJECT TO CHANGE AT ANY TIME WITHOUT NOTICE, AND SHOULD NOT BE CONSTRUED AS A COMMITMENT BY ASUS. ASUS ASSUMES NO RESPONSIBILITY OR LIABILITY FOR ANY ERRORS OR INACCURACIES THAT MAY APPEAR IN THIS MANUAL, INCLUDING THE PRODUCTS AND SOFTWARE DESCRIBED IN IT.

Copyright © 2023 ASUSTeK COMPUTER INC. All Rights Reserved.

LIMITATION OF LIABILITY

Circumstances may arise where because of a default on ASUS' part or other liability, you are entitled to recover damages from ASUS. In each such instance, regardless of the basis on which you are entitled to claim damages from ASUS, ASUS is liable for no more than damages for bodily injury (including death) and damage to real property and tangible personal property; or any other actual and direct damages resulted from omission or failure of performing legal duties under this Warranty Statement, up to the listed contract price of each product.

ASUS will only be responsible for or indemnify you for loss, damages or claims based in contract, tort or infringement under this Warranty Statement.

This limit also applies to ASUS' suppliers and its reseller. It is the maximum for which ASUS, its suppliers, and your reseller are collectively responsible.

UNDER NO CIRCUMSTANCES IS ASUS LIABLE FOR ANY OF THE FOLLOWING: (1) THIRD-PARTY CLAIMS AGAINST YOU FOR DAMAGES; (2) LOSS OF, OR DAMAGE TO, YOUR RECORDS OR DATA; OR (3) SPECIAL, INCIDENTAL, OR INDIRECT DAMAGES OR FOR ANY ECONOMIC CONSEQUENTIAL DAMAGES (INCLUDING LOST PROFITS OR SAVINGS), EVEN IF ASUS, ITS SUPPLIERS OR YOUR RESELLER IS INFORMED OF THEIR POSSIBILITY.

SERVICE AND SUPPORT

Visit our multi-language website at <https://www.asus.com/support/>.

MyASUS offers a variety of support features including troubleshooting, products performance optimization, ASUS software integration, and helps you to organize personal desktop and increase storage space. For more details, please visit <https://www.asus.com/support/FAQ/1038301/>.

Table of Contents

About this manual.....	7
Conventions used in this manual	8
Icons	8
Typography.....	8
Safety precautions.....	9
Using your Notebook PC.....	9
Caring for your Notebook PC	10
Caring for your Notebook PC	10
Proper disposal.....	11
Battery safety information.....	12

Chapter 1: Hardware Setup

Getting to know your Notebook PC	16
Front View.....	16
Top View.....	19
Bottom View	20
Right View.....	22
Left View.....	24

Chapter 2: Using your Notebook PC

Getting started	30
Charge your Notebook PC.....	30
Lift to open the display panel	33
Press the power button.....	33
Using the touchpad	34
Using the keyboard.....	41
HotKeys	41
Function keys	42
Windows keys	42

Chapter 3: Working with Windows

Starting for the first time.....	44
Start menu	45
Windows apps	47
MyASUS Splendid.....	48
Connecting to wireless networks	50
Wi-Fi.....	50
Bluetooth.....	51
Airplane mode	52
Connecting to wired networks	53
Turning your Notebook PC off.....	54
Putting your Notebook PC to sleep	55

Chapter 4: Power-On Self-Test (POST)

The Power-On Self-Test (POST).....	58
Using POST to access BIOS and Troubleshoot.....	58
BIOS	58
Accessing BIOS	58
Recovering your system.....	59
Performing a recovery option.....	60

Tips and FAQs

Useful tips for your Notebook PC	62
Hardware FAQs	64
Software FAQs.....	67

Appendices

Federal Communications Commission Interference Statement	72
FCC RF Caution Statement	73
FCC RF Exposure Information.....	73
Compliance Statement of Innovation, Science and Economic Development Canada (ISED)	74
Déclaration de conformité de Innovation, Sciences et Développement économique Canada (ISED)	74
Radiation Exposure Statement.....	75
Déclaration d'exposition aux radiations.....	75
Radio Frequency (RF) Exposure Information	76
Informations concernant l'exposition aux fréquences radio (RF)	76
Caution	77
Avertissement.....	77
UL Safety Notices.....	78
Power Safety Requirement.....	79
TV Notices	79
Macrovision Corporation Product Notice	79
Prevention of Hearing Loss	79
Coating Notice	79

Nordic Lithium Cautions (for lithium-ion batteries).....	80
Declaration of Compliance for Product Environmental Regulation.....	81
EU REACH and Article 33.....	81
EU RoHS.....	81
Japan JIS-C-0950 Material Declarations	81
India RoHS.....	81
Vietnam RoHS	82
ASUS Recycling/Takeback Services	82
Rechargeable Battery Recycling Service in North America.....	82
Ecodesign Directive	82
ENERGY STAR® Qualified Product	83
EPEAT Registered Products	83
Regional notice for Singapore	84
Notices for removable batteries.....	84
Avis concernant les batteries remplaçables.....	84
Simplified EU Declaration of Conformity	85
Simplified UKCA Declaration of Conformity.....	85

About this manual

This manual provides information about the hardware and software features of your Notebook PC, organized through the following chapters:

Chapter 1: Hardware Setup

This chapter details the hardware components of your Notebook PC.

Chapter 2: Using your Notebook PC

This chapter shows you how to use the different parts of your Notebook PC.

Chapter 3: Working with Windows

This chapter provides an overview of using Windows in your Notebook PC.

Chapter 4: Power-On Self-Test (POST)

This chapter shows you how to use POST to change the settings of your Notebook PC.

Tips and FAQs

This section presents some recommended tips, hardware FAQs, and software FAQs you can refer to for maintaining and fixing common issues with your Notebook PC.

Appendices

This section includes notices and safety statements for your Notebook PC.

Conventions used in this manual

To highlight key information in this manual, some text are presented as follows:

IMPORTANT! This message contains vital information that must be followed to complete a task.

NOTE: This message contains additional information and tips that can help complete tasks.

WARNING! This message contains important information that must be followed to keep you safe while performing tasks and prevent damage to your Notebook PC's data and components.

Icons

The icons below indicate the devices you can use for completing a series of tasks or procedures on your Notebook PC.



= Use the touchpad.



= Use the keyboard.

Typography

Bold = This indicates a menu or an item that must be selected.

Italic = This indicates sections that you can refer to in this manual.

Safety precautions

Using your Notebook PC



This Notebook PC should only be used in environments with ambient temperatures between 5°C (41°F) and 35°C (95°F).



Refer to the rating label on the bottom of your Notebook PC and ensure that your power adapter complies with this rating.



Your Notebook PC can get warm to hot while in use or while charging the battery pack. Do not leave your Notebook PC on your lap or near any part of your body to prevent injury from heat. When working on your Notebook PC, do not place it on surfaces that can block the vents.



Do not use damaged power cords, accessories, and other peripherals with your Notebook PC.



While powered on, ensure that you do not carry or cover your Notebook PC with any materials that can reduce air circulation.



Do not place your Notebook PC on uneven or unstable work surfaces.



You can send your Notebook PC through x-ray machines (used on items placed on conveyor belts), but do not expose them to magnetic detectors and wands.



Contact your airline provider to learn about related in-flight services that can be used and restrictions that must be followed when using your Notebook PC in-flight.

Caring for your Notebook PC



Disconnect the AC power and remove the battery pack (if applicable) before cleaning your Notebook PC. Use a clean cellulose sponge or chamois cloth dampened with warm water. Remove any extra moisture from your Notebook PC using a dry cloth. Keep any liquids from entering the chassis or keyboard gap to prevent short circuit or corrosion.



Do not use strong solvents such as alcohol, thinners, benzene, or other chemicals on or near your Notebook PC.



Do not place objects on top of your Notebook PC.



Do not expose your Notebook PC to strong magnetic or electrical fields.



Do not use or expose your Notebook PC near liquids, rain, or moisture.



Do not expose your Notebook PC to dusty environments.



Do not use your Notebook PC near gas leaks.



Do not place active electronic devices close to your Notebook PC to avoid electromagnetic wave interference to the display panel.



Do not use this Notebook PC for cryptocurrency mining (consuming a vast amount of electricity and time to gain convertible virtual currency) and/or related activities.

Proper disposal



Do not throw your Notebook PC in municipal waste. This product has been designed to enable proper reuse of parts and recycling. The symbol of the crossed out wheeled bin indicates that the product (electrical, electronic equipment and mercury-containing button cell battery) should not be placed in municipal waste. Check local regulations for disposal of electronic products.



Do not throw the battery in municipal waste. The symbol of the crossed out wheeled bin indicates that the battery should not be placed in municipal waste.

Battery safety information

Battery protection

- Frequently charging a battery under high voltage may shorten the battery life. To protect the battery, once the battery is fully charged, the system may stop charging when the battery power is between 90% and 100%.

NOTE: The level at which the battery resumes charging is usually set between 90% and 99%. The actual value may vary by model.

- Charging or storing a battery in high ambient temperatures may result in permanent damage to the battery power capacity and rapidly shorten battery life. If the battery temperature is too high, the system may reduce the battery power charging capacity or even stop charging to protect the battery.
- Battery power capacity may drop even when your device is powered off and disconnected from the AC power. This is normal as the system still draws a small amount of power from the battery.

Standard battery care

- If you are not using your device for a long period of time, ensure to charge the battery power to 50% then power off your device and disconnect the AC power adapter. Recharge the battery power to 50% every three months to avoid over-discharging and prevent damage to the battery.
- Avoid charging the battery at high voltage for a prolonged period of time to extend the battery life. If you are constantly using AC power for your device, ensure to discharge the battery power to 50% at least once every two weeks. You can also adjust the settings from Battery Health Charging in MyASUS to help extend the battery life.
- It is recommended to store your battery at temperatures between 5°C (41°F) and 35°C (95°F) with the battery power at 50%. You can also adjust the settings from Battery Health Charging in MyASUS to help extend the battery life.
- Do not leave your battery in damp environments. Exposure to damp environments may increase the battery over-discharging rate. Low temperature environment may damage the chemicals inside the battery while high temperature or overheating may result in a risk of explosion.
- Do not place your device or battery pack near radiators, fireplaces, furnaces, heaters, or any sources of heat with temperature exceeding 60°C (140°F). High temperature surrounding environment may result in an explosion or leakage that may cause fire.

Chapter 1: ***Hardware Setup***

Getting to know your Notebook PC

Front View

NOTE: The keyboard's layout may vary per region or country. The front view may also vary in appearance depending on the Notebook PC model.

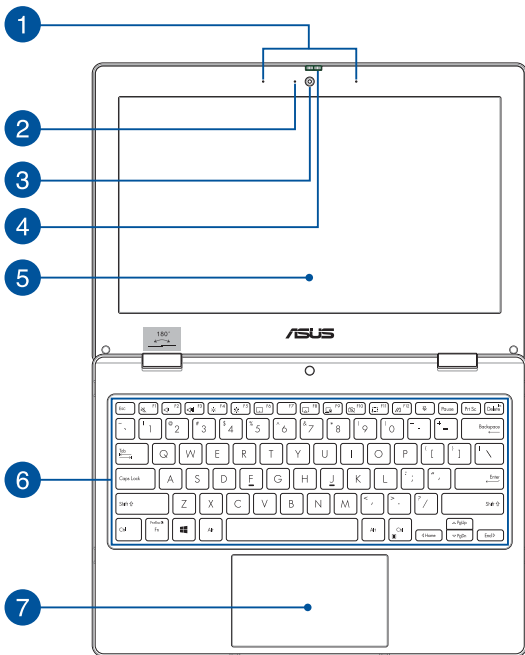

- 1 Array microphones**

The array microphones feature echo canceling, noise suppression, and beam forming functions for better voice recognition and audio recording.
- 2 Camera indicator**

The camera indicator lights up when the built-in camera is in use.
- 3 Camera**

The built-in camera allows you to take pictures or record videos using your Notebook PC.
- 4 Webcam shield**

This allows you to cover the camera lens of your Notebook PC.
- 5 Display panel**

This high-definition display panel provides excellent viewing features for photos, videos, and other multimedia files on your Notebook PC.

6 Keyboard

The keyboard provides full-sized QWERTY keys with a comfortable travel depth for typing. It also enables you to use the function keys, allows quick access to Windows, and controls other multimedia functions.

NOTE: The keyboard layout differs by model or territory.

7 Touchpad

The touchpad allows the use of multi-gestures to navigate onscreen, providing an intuitive user experience. It also simulates the functions of a regular mouse.

NOTE: For more details, refer to the *Using the touchpad* section in this manual.

Top View

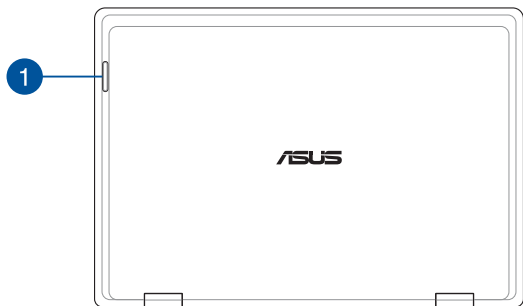

1 Status indicators

The status indicators help identify the current hardware status of your Notebook PC.

Status	Description
Slow blinking	Low battery (less than 20%) Low battery (less than 20%) and connection issue
Fast blinking	Connection issue

NOTE: Press the **Fn** key and the **1** key at the same time to enable or disable the indicator.

Bottom View

NOTE: The bottom view may vary in appearance depending on model.

WARNING! Your Notebook PC can get warm to hot while in use or while charging the battery pack. Do not leave your Notebook PC on your lap or near any part of your body to prevent injury from heat. When working on your Notebook PC, do not place it on surfaces that can block the vents.

IMPORTANT!

- Battery time varies by usage and by the specifications for this Notebook PC. The battery pack cannot be disassembled.
 - Purchase components from authorized retailers to ensure maximum compatibility and reliability. Consult an ASUS service center or authorized retailers for product service or assistance on proper disassembly or assembly of the product.
-

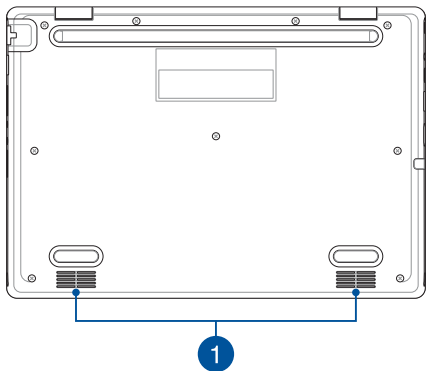

1 Audio speakers

The built-in audio speakers allow you to hear audio straight from your Notebook PC. Audio features are software-controlled.

Right View

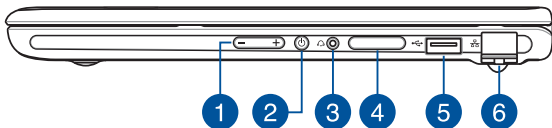

1 Volume button

This button turns the volume up or down on your Notebook PC.

2 Power button

Press the power button to turn your Notebook PC on or off. You can also use the power button to put your Notebook PC to sleep or hibernate mode and wake it up from sleep or hibernate mode.

In the event that your Notebook PC becomes unresponsive, press and hold the power button for at least four (4) seconds until your Notebook PC shuts down.

3 Headphone/Headset jack

This port allows you to connect amplified speakers or headphones. You can also use this port to connect your headset.

4 Memory card tray (on selected models)

This built-in memory card reader slot supports Nano SIM and microSD card formats. Insert a pin into the hole beside the tray to remove the tray.

5 USB 2.0 port

The USB (Universal Serial Bus) port is compatible with USB 2.0 or USB 1.1 devices such as keyboards, pointing devices, flash disk drives, external HDDs, speakers, cameras and printers.

6 LAN port

Insert the network cable into this port to connect to a local area network.

WARNING! This LAN port does not support PoE (Power over Ethernet). Connecting a PoE device to your Notebook PC may result in damage to the system board.

Left View

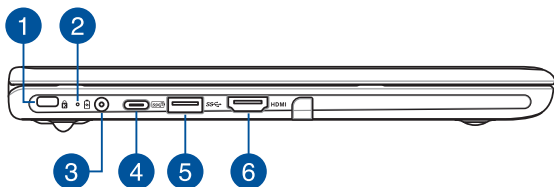

1 Kensington® security slot

The Kensington® security slot allows you to secure your Notebook PC using Kensington® compatible Notebook PC security products.

2

Two-color battery charge indicator

The two-color LED provides a visual indication of the battery's charge status. Refer to the following table for details:

Color	Status
Solid Green	The Notebook PC is plugged to a power source and the battery power is between 95% and 100%.
Solid Orange	The Notebook PC is plugged to a power source, charging its battery, and the battery power is less than 95%.
Blinking Orange	The Notebook PC is running on battery mode and the battery power is less than 10%.
Lights off	The Notebook PC is running on battery mode and the battery power is between 10% to 100%.

3 Power (DC) input port

Insert the bundled power adapter into this port to charge the battery pack and supply power to your Notebook PC.

WARNING! The adapter may become warm to hot while in use. Do not cover the adapter and keep it away from your body while it is connected to a power source.

IMPORTANT!

- Use only the bundled power adapter to charge the battery pack and supply power to your Notebook PC.
 - To prevent any damage, use only power sources rated 19V/2.37A to charge your Notebook PC.
-

4 USB 3.2 Gen 2 Type-C®/Power Delivery combo port

The USB 3.2 (Universal Serial Bus 3.2) Gen 2 Type-C® port provides a transfer rate of up to 10 Gbit/s and is backward compatible to USB 2.0. Connect a power source rated 15V/3A to charge the battery pack and supply power to your Notebook PC.

NOTE: Transfer rate of this port may vary per model.

IMPORTANT!

- It may take longer to fully charge your Notebook PC through a low-voltage power source.
 - To prevent any damage, use only power sources rated 15V/3A to charge your Notebook PC with the USB Power Delivery combo port. For more information, consult an ASUS service center for assistance.
-

5 USB 3.2 Gen 1 port

The USB 3.2 (Universal Serial Bus 3.2) Gen 1 port provides a transfer rate of up to 5 Gbit/s and is backward compatible to USB 2.0.

6 HDMI output port

This port allows you to send audio and video signals from your notebook PC to an HDMI-compatible device using an HDMI cable.

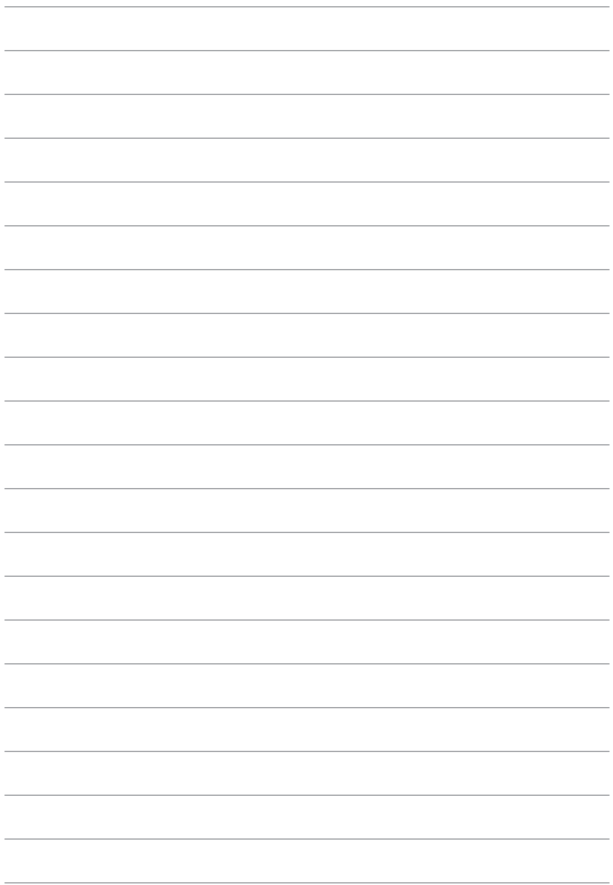

Chapter 2: ***Using your Notebook PC***

Getting started

Charge your Notebook PC

- A. Connect the AC power cord to the AC/DC adapter.
- B. Connect the DC power connector into your Notebook PC's power (DC) input port.
- C. Plug the AC power adapter into a 100V~240V power source.



Charge the Notebook PC for **3 hours** before using it in battery mode for the first time.

NOTE: The power adapter may vary in appearance, depending on models and your region.

AC/DC power adapter

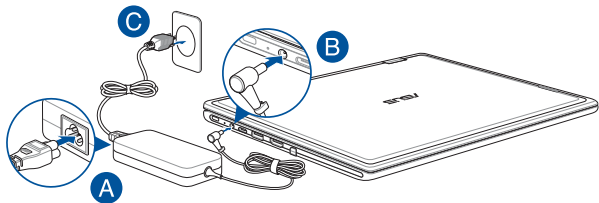

USB Type-C® power adapter

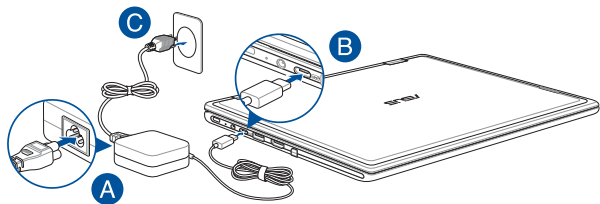

IMPORTANT!

Power adapter information:

- Input voltage: 100-240Vac
 - Input frequency: 50-60Hz
 - Rating output current: 2.37A (45W) / 3A (45W)
 - Rating output voltage: 19V / 15V
-

IMPORTANT!

- Locate the input/output rating label on your Notebook PC and ensure that it matches the input/output rating information on your power adapter. Some Notebook PC models may have multiple rating output currents based on the available SKU.
 - Ensure that your Notebook PC is connected to the power adapter before turning it on for the first time. Always plug the power cord into a wall socket without using any extension cords. For your safety, connect this device to a properly grounded electrical outlet only.
 - The socket outlet must be easily accessible and near your Notebook PC.
 - To disconnect your Notebook PC from its main power supply, unplug your Notebook PC from the power socket.
-

WARNING!

Read the following precautions for your Notebook PC's battery:

- Only ASUS-authorized technicians should remove the battery inside the device (for non-removable battery only).
 - The battery used in this device may present a risk of fire or chemical burn if removed or disassembled.
 - Follow the warning labels for your personal safety.
 - Risk of explosion if battery is replaced by an incorrect type.
 - Do not dispose of in fire.
 - Never attempt to short-circuit your Notebook PC's battery.
 - Never attempt to disassemble and reassemble the battery (for non-removable battery only).
 - Discontinue usage if leakage is found.
 - The battery and its components must be recycled or disposed of properly.
 - Keep the battery and other small components away from children.
-

Lift to open the display panel

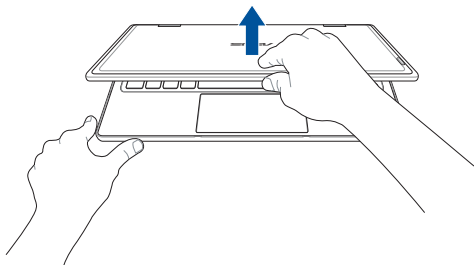

Press the power button



Using the touchpad

Moving the pointer

You can tap anywhere on the touchpad to activate its pointer, then slide your finger on the touchpad to move the pointer onscreen.

Slide horizontally

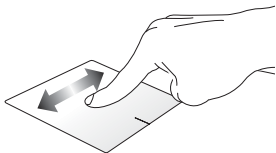

Slide vertically

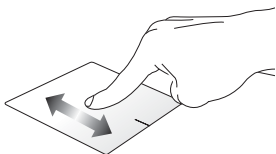

Slide diagonally

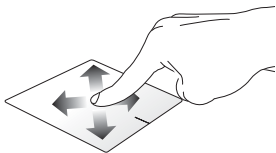

One-finger gestures

Tap/Double-tap

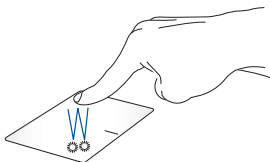

- Tap an app to select it.
- Double-tap an app to launch it.

Drag and drop

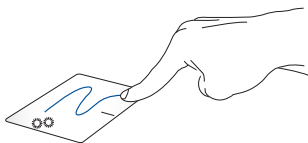

Double-tap an item, then slide the same finger without lifting it off the touchpad. To drop the item to its new location, lift your finger from the touchpad.

Left-click

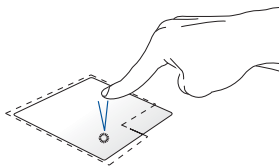

Right-click

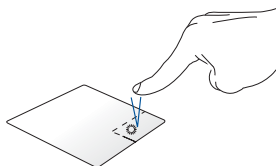

- Click an app to select it.
- Double-click an app to launch it.

Click this button to open the right-click menu.

NOTE: The areas inside the dotted line represent the locations of the left mouse button and the right mouse button on the touchpad.

Two-finger gestures

Tap

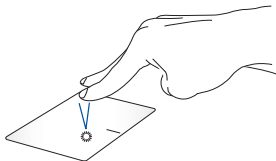

Tap two fingers on the touchpad to simulate the right-click function.

Two-finger scroll (up/down)

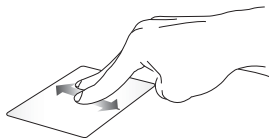

Slide two fingers to scroll up or down.

Two-finger scroll (left/right)



Slide two fingers to scroll left or right.

Zoom out



Bring together your two fingers on the touchpad.

Zoom in

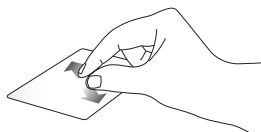

Spread apart your two fingers on the touchpad.

Drag and drop

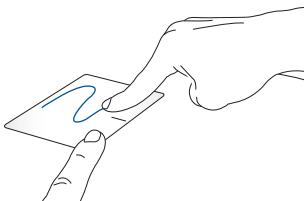

Select an item then press and hold the left button. Using your other finger, slide on the touchpad to drag the item, lift your finger off the button to drop the item.

Three-finger gestures

Tap

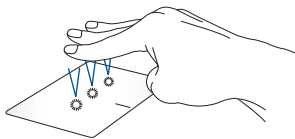

Tap three fingers on the touchpad to launch the function you selected in Settings.

Swipe left/Swipe right



If you opened multiple apps, swipe three fingers left or right to switch between these apps.

Swipe up



Swipe up to see an overview of all the apps currently opened.

Swipe down

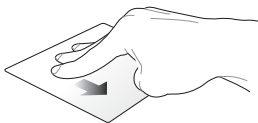

Swipe down to show the desktop.

Four-finger gestures

Tap

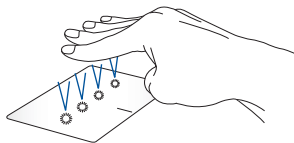

Tap four fingers on the touchpad to launch the function you selected in Settings.

Using the keyboard

HotKeys

The HotKeys on your Notebook PC's keyboard can trigger the following commands:



Turns the speaker on or off



Turns the speaker volume down



Turns the speaker volume up



Decreases display brightness



Increases display brightness



Enables or disables the touchpad



Toggles the display mode

NOTE: Ensure that the second display is connected to your Notebook PC.



Activates the Lock screen



Turns the camera on or off



Activates screen capture tool





Launches MyASUS



Turns the microphone on or off

Function keys

Press  +  to enable or disable the function keys feature.

When the function keys feature is enabled, you can also access HotKeys by holding down  in combination with the top row keys.

Windows keys

There are two special Windows keys on your Notebook PC's keyboard used as below:



or



Launches the Start menu



Displays the drop-down menu*

** On selected models*

Chapter 3:

Working with Windows

Starting for the first time

When you start your Notebook PC for the first time, a series of screens appear to guide you in configuring your Windows operating system. Follow the onscreen instructions to configure the following basic items:

- Personalize
- Get online
- Settings
- Your account

After configuring the basic items, Windows proceeds to install your apps and preferred settings. Ensure that your Notebook PC is kept powered on during the setup process. Once the setup process is complete, the Desktop appears.

NOTE: The screenshots in this chapter are for reference only.

Start menu

The Start menu is the main gateway to your Notebook PC's programs, Windows apps, folders, and settings. You can use the Start menu to do these common activities:

- Start programs or Windows apps
- Open commonly used programs or Windows apps
- Adjust Notebook PC settings
- Get help with the Windows operating system
- Turn off your Notebook PC
- Log off from Windows or switch to a different user account

Launching the Start menu



Position your mouse pointer over the Start icon on your desktop then click it.



Press the Windows logo key on your keyboard.

Opening programs from the Start menu

One of the most common uses of the Start menu is opening programs installed on your Notebook PC.



Position your mouse pointer over the program then click to launch it.



Use the arrow keys to browse through the programs.

Press  to launch it.

Windows apps

NOTE: Some Windows apps require signing in to your Microsoft account before they are fully launched.

Launching Windows apps from the Start menu



Position your mouse pointer over the app then click to launch it.



Use the arrow keys to browse through the apps. Press



to launch an app.

MyASUS Splendid

MyASUS Splendid ensures that all ASUS display panels show identical and accurate colors. You may select the Vivid, Eye Care, or Manual modes in addition to the Normal mode to adjust the display settings.

- **Normal:** Through Gamma and Color temperature correction, the image output from the panel is as close as possible as what your eye can naturally see. For models with OLED panels, this mode is compliant with TÜV Low Blue Light Certification.
- **Vivid:** This mode allows you to adjust the saturation of the image, making it more vivid and vibrant.
- **Manual:** This mode allows you to adjust the color temperature value to your personal needs, ranging from -50 to +50.
- **Eye Care:** This mode reduces blue light emission by up to 30%, helping to protect your eyes.

Level 1-5: The higher the level, the more blue light emission is reduced. For models with LCD panels, Level 5 is the optimized setting, and is compliant with TÜV Low Blue Light Certification.

Flicker-free technology eliminates the primary cause of monitor flicker and prevents eye strain.

NOTE: Enable **HDR** from **Settings > System > Display** for a better viewing experience with your OLED panel (on selected models) that is compliant with TÜV Flicker Free Certification.

Please refer to the following tips to alleviate eye strain:

- Take some time away from the display if working for long hours. It is advised to take short breaks (at least 5 minutes) after around 1 hour of continuous working at the computer. Taking short and frequent breaks is more effective than a long break.
 - To minimize eye strain and eye dryness, rest your eyes periodically by focusing on objects that are far away.
 - Repeat the following exercises to reduce eye strain:
 - (1) Look up and down repeatedly
 - (2) Slowly roll your eyes
 - (3) Move your eyes diagonally
- If eye strain persists, please consult a physician.
- High energy blue light may lead to eye strain and AMD (Age-Related Macular Degeneration). Blue light Filter reduces 30% (max.) harmful blue light to avoid CVS (Computer Vision Syndrome).

Connecting to wireless networks

Wi-Fi

Access emails, surf the Internet, and share applications via social networking sites using your Notebook PC's Wi-Fi connection.

IMPORTANT! Airplane mode disables this feature. Ensure that **Airplane mode** is turned off before enabling the Wi-Fi connection of your Notebook PC.

Connecting Wi-Fi

Connect your Notebook PC to a Wi-Fi network by using the following steps:



1. Click/Tap the **Wi-Fi** icon from the taskbar to enable Wi-Fi.
2. Select an access point from the list of available Wi-Fi connections.
3. Select **Connect** to start the network connection.

NOTE: You may be prompted to enter a security key to activate the Wi-Fi connection.

Bluetooth

Use Bluetooth to facilitate wireless data transfers with other Bluetooth-enabled devices.

IMPORTANT! Airplane mode disables this feature. Ensure that **Airplane mode** is turned off before enabling the Bluetooth connection of your Notebook PC.

Pairing with other Bluetooth-enabled devices

You need to pair your Notebook PC with other Bluetooth-enabled devices to enable data transfers. Connect your devices by using the following steps:



1. Launch **Settings** from the Start menu.
2. Select **Devices > Bluetooth** to search for Bluetooth-enabled devices. *(for Windows 10)*
Select **Bluetooth & devices > Add device** to search for Bluetooth-enabled devices. *(for Windows 11)*
3. Select a device from the list to pair your Notebook PC with the device.

NOTE: For some Bluetooth-enabled devices, you may be prompted to key in the passcode of your Notebook PC.

Airplane mode

Airplane mode disables wireless communication, allowing you to use your Notebook PC safely while in-flight.

NOTE: Contact your airline provider to learn about related in-flight services that can be used and restrictions that must be followed when using your Notebook PC in-flight.

Turning Airplane mode on/off



1. Launch **Action Center** from the taskbar.
2. Click/Tap the **Airplane mode** icon to enable or disable Airplane mode.

Connecting to wired networks

You can also connect to wired networks, such as local area networks and broadband Internet connection, using your Notebook PC's LAN port.

NOTE: Contact your Internet Service Provider (ISP) for details or your network administrator for assistance in setting up your Internet connection.



Turning your Notebook PC off

You can turn off your Notebook PC by doing either of the following procedures:



- Launch the Start menu, select the power icon then select **Shut down** to do a normal shutdown.
- From the log-in screen, select the power icon then select **Shut down**.



- Press  +  to launch Shut Down Windows. Select **Shut down** from the drop-down list then select **OK**.
- If your Notebook PC is unresponsive, press and hold the power button for at least four (4) seconds until your Notebook PC turns off.

Putting your Notebook PC to sleep

To put your Notebook PC to Sleep mode:



- Launch the Start menu, select the power icon then select **Sleep** to put your Notebook PC to sleep.
- From the log-in screen, select the power icon then select **Sleep**.



Press  +  to launch Shut Down Windows.

Select **Sleep** from the drop-down list then select **OK**.

NOTE: You can also put your Notebook PC to Sleep mode by pressing the power button once.

Chapter 4:

Power-On Self-Test (POST)

The Power-On Self-Test (POST)

The POST (Power-On Self-Test) is a series of software-controlled diagnostic tests that run when you turn on or restart your Notebook PC. The software that controls the POST is installed as a permanent part of the Notebook PC's architecture.

Using POST to access BIOS and Troubleshoot

During POST, you can access the BIOS settings or run troubleshooting options using the function keys of your Notebook PC. You may refer to the following information for more details.

BIOS

The BIOS (Basic Input and Output System) stores system hardware settings that are needed for system startup in the Notebook PC.

The default BIOS settings apply to most conditions of your Notebook PC. Do not change the default BIOS settings except in the following circumstances:

- An error message appears onscreen during system bootup and requests you to run the BIOS Setup.
- You have installed a new system component that requires further BIOS settings or updates.

WARNING! Using inappropriate BIOS settings may result to system instability or boot failure. We strongly recommend that you change the BIOS settings only with the help of a trained service personnel.

Accessing BIOS

Restart your Notebook PC then press  during POST.

Recovering your system

Using recovery options on your Notebook PC allows you to restore the system to its original state or simply refresh its settings to help improve performance.

IMPORTANT!

- Backup all your data files before doing any recovery option on your Notebook PC.
 - Note down important customized settings such as network settings, user names, and passwords to avoid data loss.
 - Ensure that your Notebook PC is plugged in to a power source before resetting your system.
-

Windows allows you to do any of the following recovery options:

- **Keep my files** - This option allows you to refresh your Notebook PC without affecting personal files (photos, music, videos, documents).

Using this option, you can restore your Notebook PC to its default settings and delete other installed apps.

- **Remove everything** - This option resets your Notebook PC to its factory settings. You must backup your data before doing this option.

- **Advanced startup** - Using this option allows you to perform other advanced recovery options on your Notebook PC such as:
 - Using a USB drive, network connection or Windows recovery DVD to startup your Notebook PC.
 - Using **Troubleshoot** to enable any of these advanced recovery options: Startup Repair, Uninstall Updates, Startup Settings, UEFI Firmware Settings, Command Prompt, System Restore, and System Image Recovery.

Performing a recovery option

Refer to the following steps if you want to access and use any of the available recovery options for your Notebook PC.

1. Launch **Settings** > **Update and security**. *(for Windows 10)*
Launch **Settings** > **System** > **Recovery**. *(for Windows 11)*
2. Select the recovery option you would like to perform.

Tips and FAQs

Useful tips for your Notebook PC

To help you maximize the use of your Notebook PC, maintain its system performance, and ensure all your data are kept secured, here are some useful tips that you can follow:

- Update Windows periodically to ensure that your applications have the latest security settings.
- Update MyASUS to ensure that you have the latest settings for ASUS exclusive applications, drivers, and utilities.
- Use an anti-virus software to protect your data and keep this updated too.
- Unless absolutely necessary, refrain from using force shutdown to turn off your Notebook PC.
- Always backup your data and make it a point to create a backup data in an external storage drive.
- If you are not using your Notebook PC for a long period of time, ensure to charge the battery power to 50% then power off your Notebook PC and disconnect the AC power adapter.
- If you are constantly using AC power for your Notebook PC, set the Battery Health Charging to Balanced mode in MyASUS.

- Disconnect all external devices and ensure you have the following items prior to resetting your Notebook PC:
 - Product key for your operating systems and other installed applications
 - Backup data
 - Log in ID and password
 - Internet connection information
- Visit our support site for troubleshooting and view some of the most frequently asked questions at <https://www.asus.com/support>.

Hardware FAQs

1. A black dot, or sometimes a colored dot, appears onscreen when I turn on the Notebook PC. What should I do?

Although these dots normally appear onscreen, they will not affect your system. If the incident continues and subsequently affects system performance, consult an authorized ASUS service center.

2. My display panel has an uneven color and brightness. How can I fix this?

The color and brightness of your display panel may be affected by the angle and current position of your Notebook PC. The brightness and color tone of your Notebook PC may also vary per model. You may use the function keys or the display settings in your operating system to adjust the appearance of your display panel.

3. How can I maximize my Notebook PC's battery life?

You can try doing any of the following suggestions:

- Use the function keys to adjust the display brightness.
- If you are not using any Wi-Fi connection, switch your system into **Airplane mode**.
- Disconnect unused USB devices.
- Close unused applications, especially those that take up too much system memory.

4. **My battery charge indicator does not light up. What's wrong?**

- Check whether the power adapter or battery pack is attached correctly. You may also disconnect the power adapter or battery pack, wait for a minute, then reconnect them again to the power outlet and Notebook PC.
- If the problem still exists, contact your local ASUS service center for assistance.

5. **Why is my touchpad not working?**

Press  to enable your touchpad.

6. **When I play audio and video files, why can't I hear any sound from my Notebook PC's audio speakers?**

You can try doing any of the following suggestions:

- Press  to turn up the speaker volume.
- Check if your speakers were set to mute.
- Check if a headphone jack is connected to your Notebook PC and remove it.

7. What should I do if my Notebook PC's power adapter gets lost or my battery stops working?

Contact your local ASUS service center for assistance.

8. My Notebook PC cannot do keystrokes correctly because my cursor keeps on moving. What should I do?

Make sure that nothing accidentally touches or presses on your touchpad while you type on the keyboard. You can also disable your touchpad by pressing  .

Software FAQs

1. When I turn on my Notebook PC, the power indicator lights up but nothing appears on my screen. What can I do to fix this?

You can try doing any of the following suggestions:

- Force shutdown your Notebook PC by pressing the power button for at least four (4) seconds. Check if the power adapter and battery pack are inserted correctly then turn on your Notebook PC.
- If the problem still exists, contact your local ASUS service center for assistance.

2. What should I do when my screen displays this message: "Remove disks or other media. Press any key to restart."?

You can try doing any of the following suggestions:

- Remove all connected USB devices then restart your Notebook PC.
- Remove any optical discs that are left inside the optical drive then restart.
- If the problem still exists, your Notebook PC might have a memory storage problem. Contact your local ASUS service center for assistance.

3. My Notebook PC boots slower than usual and my operating system lags. How can I fix this?

Delete the applications you recently installed or were not included with your operating system package then restart your system.

4. My Notebook PC does not boot up. How can I fix this?

You can try doing any of the following suggestions:

- Remove all connected devices to your Notebook PC then restart your system.
- If the problem still exists, contact your local ASUS service center for assistance.

5. Why can't my Notebook PC wake up from sleep mode?

- You need to press the power button to resume your last working state.
- Your system might have completely used up its battery power. Connect the power adapter to your Notebook PC and connect to a power outlet then press the power button.

6. Does my Notebook PC support eSIM? If so, how can I enable eSIM on my Notebook PC?

Visit <https://www.asus.com/support/FAQ/1048158/> for details on eSIM activation.

To determine if your Notebook PC supports eSIM, follow the steps on the web page and see if the “eSIM” option appears after step 3. If your Notebook PC supports eSIM, proceed with the rest of the steps to connect your Notebook PC to a cellular data network using an eSIM profile.

If you have any other problems, please visit <https://www.asus.com/support/FAQ/1045091/> for troubleshooting.

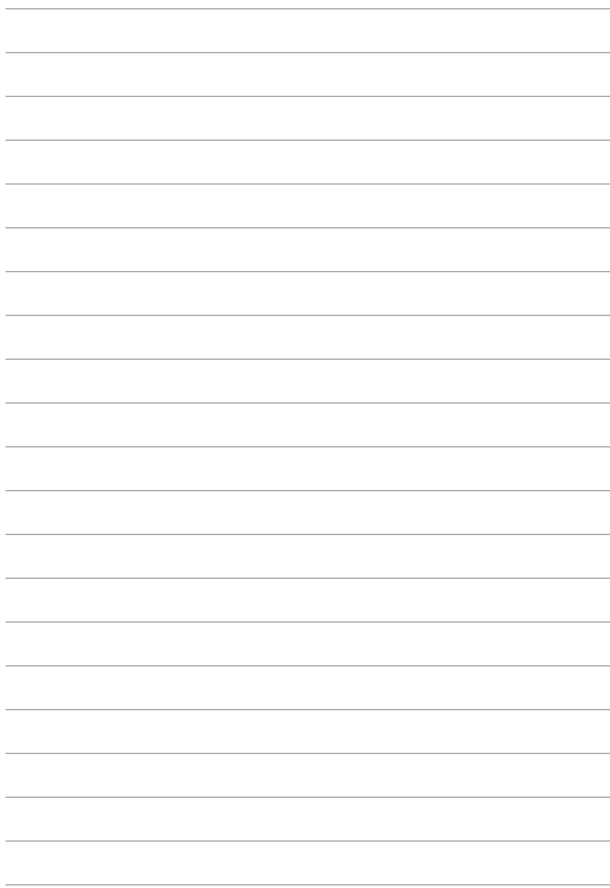

Appendices

Federal Communications Commission Interference Statement

This device complies with FCC Rules Part 15. Operation is subject to the following two conditions:

- This device may not cause harmful interference.
- This device must accept any interference received, including interference that may cause undesired operation.

This equipment has been tested and found to comply with the limits for a class B digital device, pursuant to Part 15 of the Federal Communications Commission (FCC) rules. These limits are designed to provide reasonable protection against harmful interference in a residential installation. This equipment generates, uses, and can radiate radio frequency energy and, if not installed and used in accordance with the instructions, may cause harmful interference to radio communications. However, there is no guarantee that interference will not occur in a particular installation. If this equipment does cause harmful interference to radio or television reception, which can be determined by turning the equipment off and on, the user is encouraged to try to correct the interference by one or more of the following measures:

- Reorient or relocate the receiving antenna.
- Increase the separation between the equipment and receiver.
- Connect the equipment into an outlet on a circuit different from that to which the receiver is connected.
- Consult the dealer or an experienced radio/TV technician for help.

WARNING! The use of a shielded-type power cord is required in order to meet FCC emission limits and to prevent interference to the nearby radio and television reception. It is essential that only the supplied power cord be used. Use only shielded cables to connect I/O devices to this equipment. You are cautioned that changes or modifications not expressly approved by the party responsible for compliance could void your authority to operate the equipment.

(Reprinted from the Code of Federal Regulations #47, part 15.193, 1993.
Washington DC: Office of the Federal Register, National Archives and Records
Administration, U.S. Government Printing Office.)

FCC RF Caution Statement

WARNING! Any changes or modifications not expressly approved by the party responsible for compliance could void the user's authority to operate this equipment.

FCC RF Exposure Information

This device meets the government's requirements for exposure to radio waves. This device is designed and manufactured not to exceed the emission limits for exposure to radio frequency (RF) energy set by the Federal Communications Commission of the U.S. Government. The exposure standard employs a unit of measurement known as the Specific Absorption Rate, or SAR. The SAR limit set by the FCC is 1.6 W/kg. Tests for SAR are conducted using standard operating positions accepted by the FCC with the EUT transmitting at the specified power level in different channels. The FCC has granted an Equipment Authorization for this device with all reported SAR levels evaluated as in compliance with the FCC RF exposure guidelines. SAR information on this device is on file with the FCC and can be found under the Display Grant section of www.fcc.gov/oet/ea/fccid.

Compliance Statement of Innovation, Science and Economic Development Canada (ISED)

This device complies with *Innovation, Science and Economic Development Canada* license exempt RSS standard(s). Operation is subject to the following two conditions: (1) this device may not cause interference, and (2) this device must accept any interference, including interference that may cause undesired operation of the device.

Operation in the band 5150-5250 MHz is only for indoor use to reduce the potential for harmful interference to co-channel mobile satellite systems.

CAN ICES-003(B)/NMB-003(B)

Déclaration de conformité de Innovation, Sciences et Développement économique Canada (ISED)

Le présent appareil est conforme aux CNR d'*Innovation, Sciences et Développement économique Canada* applicables aux appareils radio exempts de licence.

L'exploitation est autorisée aux deux conditions suivantes: (1) l'appareil ne doit pas produire de brouillage, et (2) l'utilisateur de l'appareil doit accepter tout brouillage radioélectrique subi, même si le brouillage est susceptible d'en compromettre le fonctionnement.

La bande 5150-5250 MHz est réservée uniquement pour une utilisation à l'intérieur afin de réduire les risques de brouillage préjudiciable aux systèmes de satellites mobiles utilisant les mêmes canaux.

CAN ICES-003(B)/NMB-003(B)

Radiation Exposure Statement

The product comply with the Canada portable RF exposure limit set forth for an uncontrolled environment and are safe for intended operation as described in this manual. The further RF exposure reduction can be achieved if the product can be kept as far as possible from the user body or set the device to lower output power if such function is available.

Déclaration d'exposition aux radiations

Le produit est conforme aux limites d'exposition pour les appareils portables RF pour les États-Unis et le Canada établies pour un environnement non contrôlé.

Le produit est sûr pour une utilisation telle que décrite dans ce manuel. Le niveau d'exposition aux ondes radio peut être réduit en plaçant l'appareil aussi loin que possible du corps de l'utilisateur ou que le dispositif est réglé sur la puissance de sortie la plus faible si une telle fonction est disponible.

Radio Frequency (RF) Exposure Information

The radiated output power of the Wireless Device is below the Industry Canada (IC) radio frequency exposure limits. The Wireless Device should be used in such a manner such that the potential for human contact during normal operation is minimized.

This device has been evaluated for and shown compliant with the IC Specific Absorption Rate ("SAR") limits when operated in portable exposure conditions.

Informations concernant l'exposition aux fréquences radio (RF)

La puissance de sortie émise par cet appareil sans fil est inférieure à la limite d'exposition aux fréquences radio d'Industrie Canada (IC). Utilisez l'appareil sans fil de façon à minimiser les contacts humains lors d'un fonctionnement normal.

Cet appareil a été évalué et démontré conforme aux limites de DAS (Débit d'absorption spécifique) d'IC lorsqu'il est utilisé dans des conditions d'exposition à des appareils portables.

Caution

- (i) the device for operation in the band 5150-5250 MHz is only for indoor use to reduce the potential for harmful interference to co-channel mobile satellite systems;
- (ii) the maximum antenna gain permitted for devices in the bands 5250-5350 MHz and 5470-5725 MHz shall comply with the e.i.r.p. limit; and
- (iii) the maximum antenna gain permitted for devices in the band 5725-5825 MHz shall comply with the e.i.r.p. limits specified for point-to-point and non point-to-point operation as appropriate.
- (iv) Users should also be advised that high-power radars are allocated as primary users (i.e. priority users) of the bands 5250-5350 MHz and 5650-5850 MHz and that these radars could cause interference and/or damage to LE-LAN devices.

Avertissement

Le guide d'utilisation des dispositifs pour réseaux locaux doit inclure des instructions précises sur les restrictions susmentionnées, notamment:

- (i) Les dispositifs fonctionnant dans la bande 5150-5250 MHz sont réservés uniquement à une utilisation en intérieur afin de réduire les risques d'interférence préjudiciables aux systèmes de satellites mobiles utilisant les mêmes canaux;
- (ii) Le gain maximal d'antenne permis pour les dispositifs utilisant les bandes 5250-5350 MHz et 5470-5725 MHz doit être conforme à la limite de P.I.R.E; et
- (iii) Le gain maximal d'antenne permis (pour les dispositifs utilisant la bande 5725-5825 MHz) doit être conforme à la limite de P.I.R.E spécifiée pour l'exploitation point à point et non point à point, selon le cas.
- (iv) De plus, les utilisateurs devraient aussi être avisés que les utilisateurs de radars de haute puissance sont désignés utilisateurs principaux (c.-à-d., qu'ils ont la priorité) pour les bandes 5250-5350 MHz et 5650-5850 MHz et que ces radars pourraient créer des interférences et/ou des dommages aux dispositifs LAN-EL.

UL Safety Notices

Required for UL 1459 covering telecommunications (telephone) equipment intended to be electrically connected to a telecommunication network that has an operating voltage to ground that does not exceed 200V peak, 300V peak-to-peak, and 105V rms, and installed or used in accordance with the National Electrical Code (NFPA 70).

When using the Notebook PC modem, basic safety precautions should always be followed to reduce the risk of fire, electric shock, and injury to persons, including the following:

- DO NOT use the Notebook PC near water, for example, near a bath tub, wash bowl, kitchen sink or laundry tub, in a wet basement or near a swimming pool.
- DO NOT use the Notebook PC during an electrical storm. There may be a remote risk of electric shock from lightning.
- DO NOT use the Notebook PC in the vicinity of a gas leak.

Required for UL 1642 covering primary (non-rechargeable) and secondary (rechargeable) lithium batteries for use as power sources in products. These batteries contain metallic lithium, or a lithium alloy, or a lithium ion, and may consist of a single electrochemical cell or two or more cells connected in series, parallel, or both, that convert chemical energy into electrical energy by an irreversible or reversible chemical reaction.

- DO NOT dispose the Notebook PC battery pack in a fire, as they may explode. Check with local codes for possible special disposal instructions to reduce the risk of injury to persons due to fire or explosion.
- DO NOT use power adapters or batteries from other devices to reduce the risk of injury to persons due to fire or explosion. Use only UL certified power adapters or batteries supplied by the manufacturer or authorized retailers.

Power Safety Requirement

Products with electrical current ratings up to 6A and weighing more than 3Kg must use approved power cords greater than or equal to: H05VV-F, 3G, 0.75mm² or H05VV-F, 2G, 0.75mm².

TV Notices

Note to CATV System Installer—Cable distribution system should be grounded (earthed) in accordance with ANSI/NFPA 70, the National Electrical Code (NEC), in particular Section 820.93, Grounding of Outer Conductive Shield of a Coaxial Cable – installation should include bonding the screen of the coaxial cable to the earth at the building entrance.

Macrovision Corporation Product Notice

This product incorporates copyright protection technology that is protected by method claims of certain U.S.A. patents and other intellectual property rights owned by Macrovision Corporation and other rights owners. Use of this copyright protection technology must be authorized by Macrovision Corporation, and is intended for home and other limited viewing uses only *unless otherwise authorized by Macrovision Corporation*. Reverse engineering or disassembly is prohibited.

Prevention of Hearing Loss

To prevent possible hearing damage, do not listen at high volume levels for long periods.



Coating Notice

IMPORTANT! To provide electrical insulation and maintain electrical safety, a coating is applied to insulate the device except on the areas where the I/O ports are located.

Nordic Lithium Cautions (for lithium-ion batteries)

CAUTION! Danger of explosion if battery is incorrectly replaced. Replace only with the same or equivalent type recommended by the manufacturer. Dispose of used batteries according to the manufacturer's instructions. (English)

ATTENZIONE! Rischio di esplosione della batteria se sostituita in modo errato. Sostituire la batteria con un una di tipo uguale o equivalente consigliata dalla fabbrica. Non disperdere le batterie nell'ambiente. (Italian)

VORSICHT! Explosionsgefahr bei unsachgemäßen Austausch der Batterie. Ersatz nur durch denselben oder einem vom Hersteller empfohlenem ähnlichen Typ. Entsorgung gebrauchter Batterien nach Angaben des Herstellers. (German)

ADVARSEL! Lithiumbatteri - Eksplosionsfare ved fejlagtig håndtering. Udskiftning må kun ske med batteri af samme fabrikat og type. Levér det brugte batteri tilbage til leverandøren. (Danish)

WARNING! Explosionsfara vid felaktigt batteribyte. Använd samma batterityp eller en ekvivalent typ som rekommenderas av apparattillverkaren. Kassera använt batteri enligt fabrikantens instruktion. (Swedish)

VAROITUS! Paristo voi räjähtää, jos se on virheellisesti asennettu. Vaihda paristo ainoastaan laitevalmistajan suosittellemaan tyyppiin. Hävitä käytetty paristo valmistagan ohjeiden mukaisesti. (Finnish)

ATTENTION! Danger d'explosion si la batterie n'est pas correctement remplacée. Remplacer uniquement avec une batterie de type semblable ou équivalent, recommandée par le fabricant. Jeter les batteries usagées conformément aux instructions du fabricant. (French)

ADVARSEL! Eksplosjonsfare ved feilaktig skifte av batteri. Benytt samme batteritype eller en tilsvarende type anbefalt av apparatfabrikanten. Brukte batterier kasseres i henhold til fabrikantens instruksjoner. (Norwegian)

標準品以外の使用は、危険の元になります。交換品を使用する場合、製造者に指定されるものを使って下さい。製造者の指示に従って処理して下さい。(Japanese)

ВНИМАНИЕ! При замене аккумулятора на аккумулятор иного типа возможно его возгорание. Утилизируйте аккумулятор в соответствии с инструкциями производителя. (Russian)

Declaration of Compliance for Product Environmental Regulation

ASUS follows the green design concept to design and manufacture our products, and makes sure that each stage of the product life cycle of ASUS product is in line with global environmental regulations. In addition, ASUS disclose the relevant information based on regulation requirements.

Please refer to <http://csr.asus.com/Compliance.htm> for information disclosure based on regulation requirements ASUS is complied with.

EU REACH and Article 33

Complying with the REACH (Registration, Evaluation, Authorization, and Restriction of Chemicals) regulatory framework, we publish the chemical substances in our products at ASUS REACH website at <http://csr.asus.com/english/REACH.htm>.

EU RoHS

This product complies with the EU RoHS Directive. For more details, see <http://csr.asus.com/english/article.aspx?id=35>.

Japan JIS-C-0950 Material Declarations

Information on Japan RoHS (JIS-C-0950) chemical disclosures is available on <http://csr.asus.com/english/article.aspx?id=19>.

India RoHS

This product complies with the "India E-Waste (Management) Rules, 2016" and prohibits use of lead, mercury, hexavalent chromium, polybrominated biphenyls (PBBs) and polybrominated diphenyl ethers (PBDEs) in concentrations exceeding 0.1% by weight in homogenous materials and 0.01% by weight in homogenous materials for cadmium, except for the exemptions listed in Schedule II of the Rule.

Vietnam RoHS

ASUS products sold in Vietnam, on or after September 23, 2011, meet the requirements of the Vietnam Circular 30/2011/TT-BCT.

Các sản phẩm ASUS bán tại Việt Nam, vào ngày 23 tháng 9 năm 2011 trở về sau, đều phải đáp ứng các yêu cầu của Thông tư 30/2011/TT-BCT của Việt Nam.

ASUS Recycling/Takeback Services

ASUS recycling and takeback programs come from our commitment to the highest standards for protecting our environment. We believe in providing solutions for you to be able to responsibly recycle our products, batteries, other components as well as the packaging materials.

Please go to <http://csr.asus.com/english/Takeback.htm> for detailed recycling information in different regions.

Rechargeable Battery Recycling Service in North America



For US and Canada customers, you can call 1-800-822-8837 (toll-free) for recycling information of your ASUS products' rechargeable batteries.

Ecodesign Directive

European Union announced a framework for the setting of ecodesign requirements for energy-related products (2009/125/EC). Specific Implementing Measures are aimed at improving environmental performance of specific products or across multiple product types. ASUS provides product information on the CSR website. Further information could be found at <https://csr.asus.com/english/article.aspx?id=1555>.

ENERGY STAR® Qualified Product



ENERGY STAR® is a joint program of the U.S. Environmental Protection Agency and the U.S. Department of Energy helping us all save money and protect the environment through energy efficient products and practices.

All ASUS products with the ENERGY STAR® logo comply with the ENERGY STAR® standard, and the power management feature is enabled by default. The monitor is automatically set to sleep within 10 minutes of user inactivity; the computer is automatically set to sleep within 30 minutes of user inactivity. To wake your computer, click the mouse, press any key on the keyboard, or press the power button.

Please visit <https://www.energystar.gov/powermanagement> for detailed information on power management and its benefits to the environment. In addition, please visit <https://www.energystar.gov> for detailed information on the ENERGY STAR® joint program.

NOTE: ENERGY STAR® is NOT supported on FreeDOS and Linux-based products.

EPEAT Registered Products

The public disclosure of key environmental information for ASUS EPEAT (Electronic Product Environmental Assessment Tool) registered products is available at <https://csr.asus.com/english/article.aspx?id=41>. More information about EPEAT program and purchase guidance can be found at www.epeat.net.

Regional notice for Singapore

Complies with IMDA Standards DB103778

This ASUS product complies with IMDA Standards.

Notices for removable batteries

- Risk of explosion if battery is replaced by an incorrect type.
- The battery and its component must be recycled or disposed of properly.

Avis concernant les batteries remplaçables

- La batterie de l'appareil peut présenter un risque d'incendie ou de brûlure si celle-ci est retirée ou désassemblée.
- La batterie et ses composants doivent être recyclés de façon appropriée.

Simplified EU Declaration of Conformity

ASUSTek Computer Inc. hereby declares that this device is in compliance with the essential requirements and other relevant provisions of Directive 2014/53/EU. Full text of EU declaration of conformity is available at <https://www.asus.com/support/>.

The WiFi operating in the band 5150-5350 MHz shall be restricted to indoor use for countries listed in the table below:

AT	BE	BG	CZ	DK	EE	FR
DE	IS	IE	IT	EL	ES	CY
LV	LI	LT	LU	HU	MT	NL
NO	PL	PT	RO	SI	SK	TR
FI	SE	CH	HR	UK(NI)		



Simplified UKCA Declaration of Conformity

ASUSTek Computer Inc. hereby declares that this device is in compliance with the essential requirements and other relevant provisions of The Radio Equipment Regulations 2017 (S.I. 2017/1206). Full text of UKCA declaration of conformity is available at <https://www.asus.com/support/>.

The WiFi operating in the band 5150-5350 MHz shall be restricted to indoor use for the country listed below:



