

Honeywell

ScanPal EDA10A

Enterprise Tablet
powered by Android™



User Guide

Disclaimer

Honeywell International Inc. (“HII”) reserves the right to make changes in specifications and other information contained in this document without prior notice, and the reader should in all cases consult HII to determine whether any such changes have been made. HII makes no representation or warranties regarding the information provided in this publication.

HII shall not be liable for technical or editorial errors or omissions contained herein; nor for incidental or consequential damages resulting from the furnishing, performance, or use of this material. HII disclaims all responsibility for the selection and use of software and/or hardware to achieve intended results.

This document contains proprietary information that is protected by copyright. All rights are reserved. No part of this document may be photocopied, reproduced, or translated into another language without the prior written consent of HII.

Copyright © 2024 Honeywell Group of Companies. All rights reserved.

Web Address: sps.honeywell.com

Trademarks

Google and Android are trademarks of Google LLC.

Bluetooth trademarks are owned by Bluetooth SIG, Inc., U.S.A. and licensed to Honeywell.

microSD is a registered trademark of SD-3C, LLC.

Other product names mentioned in this manual may be trademarks or registered trademarks of their respective companies and are the property of their respective owners.

Patents

For patent information, see www.hsmpats.com.

TABLE OF CONTENTS

Customer Support	vii
Technical Assistance	vii
Product Service and Repair	vii
Limited Warranty	vii
Chapter 1 - Tablet Features.....	1
EDA10A ScanPal Enterprise Tablet.....	1
EDA10A Model Overview	2
Tablet Features.....	3
About the Battery	5
Charge the Battery	6
Charge the Battery Before Use.....	6
Battery Replacement.....	6
Battery Life Cycle.....	7
Replace the Battery.....	8
About the Battery Status.....	11
About the Battery Status LED Setting.....	11
Check the Battery Level and Usage	12
Battery Life and Conservation.....	13
Battery Recommendations and Safety Precautions	13
Enable Airplane Mode	14
Power On the Tablet	15
Welcome Screen.....	15
Unlock the Screen	15
Unlock with Face Unlock.....	16

Change the Screen Lock to Protect the Tablet.....	16
Set Up Face Unlock.....	17
Remove Face Unlock.....	17
Select Glove Mode to Optimize Performance	17
Configure the Screen Backlight.....	18
About the Audio Features	18
Audio Settings	18
Adjust Volume.....	19
Install a Micro SIM Card.....	19
Insert a microSD Card (Optional).....	20
How to Transfer Files.....	20
Configure USB Connection and Transfer Files	20
Accessories for the EDA10A	21

Chapter 2 - About the User Interface and Applications 23

About the User Interface.....	23
Navigation and Function Buttons	24
About Status Bar Icons	25
Remap a Button or Key.....	25
Restore Default Button Action	26
View and Manage Notifications	26
Open Quick Settings	27
Customize the Home Screen	27
Customize the Favorites Tray	28
Use Google™ Search.....	28
About Screen Gestures	28
Set the Time Zone.....	29
About Honeywell Applications.....	29
Applications You Can Download to the Tablet	31
Unlock Developer Options	32

Chapter 3 - Use the Image Engine 33

About the Image Engine	33
------------------------------	----

- About the Scan Wedge Feature.....33
- Change the Scanner Settings34
 - Restore Default Scan Settings34
 - Default Scan Settings35
 - Add a Scan Setting Profile.....41
 - Delete a Scan Setting Profile41
 - Change the Bluetooth Scanner Settings41
- About the Optional Digital Scan Button42
 - Enable and Configure the Digital Scan Button42
- Scan Barcodes.....42
 - Scan Barcodes with the Imager43
 - Scan Barcodes with the Rear Camera44
 - About Scanning Configuration Barcodes44
- Use the Scan Demo App45
 - Change the Scan Demo Symbology Settings45

Chapter 4 - Use the Phone47

- About the Phone.....47
 - Activate the Phone47
 - Provision eSIM.....48
 - Provision nano-SIM Card49
- Make a Phone Call.....50
- Answer the Phone50
 - Switch Apps During a Phone Call.....51
- Make an Emergency Phone Call.....51
- Configure Phone Settings51

Chapter 5 - Use the Camera53

- About the Color Camera53
 - How to Zoom.....53
- Take a Photo53
- Record a Video.....54
- Change Camera Settings54

Use the Camera as a Flashlight..... 55

Chapter 6 - Configure the Computer..... 57

How to Configure the Computer..... 57

- Start the Settings App 57
- About the Structure of the Settings App 57

About Network Communications 68

- Connect to a Wi-Fi Network 68
- Connect to an Ethernet Network..... 70
- How to Connect to Virtual Private Networks 71

About Wireless Security..... 72

- About Certificates 72

About Bluetooth Communications 73

- Connect a Bluetooth Device 74
- Rename the Computer 74
- Rename, Share or Unpair a Paired Device..... 74

About the Scanner Edge App 75

About Serial and USB Communications..... 76

- USB Troubleshooting..... 76

About Near Field Communication (NFC) 77

Developer Information..... 78

About Provisioning Mode 78

- Enable or Disable Provisioning Mode..... 78

Chapter 7 - Manage and Maintain the Computer..... 79

About Software Updates and Cyber Security 79

- Software Downloads 79
- About Transferring Files via USB Connection 80

Install Software with AutoInstall..... 80

- Optional microSD Card Method..... 81

About the Honeywell Upgrader 81

Restart (Reboot) the Computer..... 81

About Enterprise Data Reset..... 82

Before You Begin.....	82
Enterprise Data Reset the Computer.....	82
About Erase All Data (Factory Reset)	83
Before You Begin.....	83
Erase All Data (Factory Reset).....	83
Repairs.....	84
Maintenance	84
Clean the Tablet.....	84

Appendix A - Specifications85

Computer Agency Information	85
Label Locations.....	85
Physical and Environmental Specifications	85
Barcode Symbologies Supported	86
S0703-SR (Standard Range) Imager	86
S0703 Imager Field of View/Resolution	88

Customer Support

Technical Assistance

Go to honeywell.com/PSStechnicalsupport to search our knowledge base for a solution or to log into the Technical Support portal.

Product Service and Repair

Honeywell International Inc. provides service for all of its products through service centers throughout the world. Go to sps.honeywell.com and select **Support > Productivity** to find a service center near you or to get a Return Material Authorization number (RMA #) before returning a product.

Limited Warranty

For warranty information, go to sps.honeywell.com and select **Support > Productivity > Warranties**.

TABLET FEATURES

This chapter introduces the EDA10A ScanPal Enterprise Tablet with Android operating system. Use this chapter to learn about the basic tablet features, functions, and accessories.

Note: *Applications and settings vary by OS version. Your tablet may not include all the features shown in this manual.*

EDA10A ScanPal Enterprise Tablet

ScanPal EDA10A Enterprise tablets deliver real-time connectivity, advanced data capture, and future-proof investment protection. All EDA10A models come equipped for fast Wi-Fi connectivity with a WLAN 802.11 a/b/g/n/ac/r/k/mc/ax radio and Bluetooth (v5.1) technology that includes Bluetooth Low Energy (BLE) support. EDA10A-1 models provide additional connectivity with a Wireless Wide Area Network (WWAN) radio for high-speed data and quality voice support across all network technologies. EDA10A WWAN models also include an integrated global positioning satellite (GPS) receiver that supports GPS protocols including simultaneous GNSS Receiver Support for GPS, GLONASS, Galileo and BeiDou.

To learn more about the EDA10A mobile computer, refer to the [EDA10A Model Overview](#) on page 2.

EDA10A Model Overview

Available Features	Model EDA10A-0	Model EDA10A-1
Android operating system*	x	x
Qualcomm SM4350-AC, octa-core, 2.2 GHz processor	x	x
4 GB DDR4 RAM, 64 GB flash memory	x	x
8 GB DDR4 RAM, 128 GB flash memory	x	x
Honeywell high performance 2D imager (Imager availability is model dependent)	x	x
USB Type C connector for communication/charging	x	x
Hot swappable battery feature	x	x
High-tier rugged specifications rated to IP65	x	x
WLAN IEEE 802.11a/b/g/n/ac/r/k/mc/ax (Wi-Fi 6); Wi-Fi certified	x	x
Bluetooth™ V5.1 wireless technology	x	x
NFC technology for short-range wireless data exchange	x	x
Wireless WWAN radio for high speed data and quality voice support across all network technologies		x
Customer-accessible microSD™ slot for removable memory cards up to 2 TB (SDXC/SDHC/SDIO-compliant)	x	x
16-megapixel color camera with video image stabilization and advanced software features for enhanced exposure control	x	x
8-megapixel front-facing camera	x	x
Value-added software components	x	x
10.1", full, high definition (1920 x 1200) resolution, bright color, outdoor-readable display with responsive multi-touch capacitive touch panel**	x	x
<p>* For information on supported Android OS versions, see the EDA10A Data Sheet, available at sps.honeywell.com.</p> <p>** Use of a screen protector may have a small effect on the capacitive touch panel performance.</p>		

Tablet Features

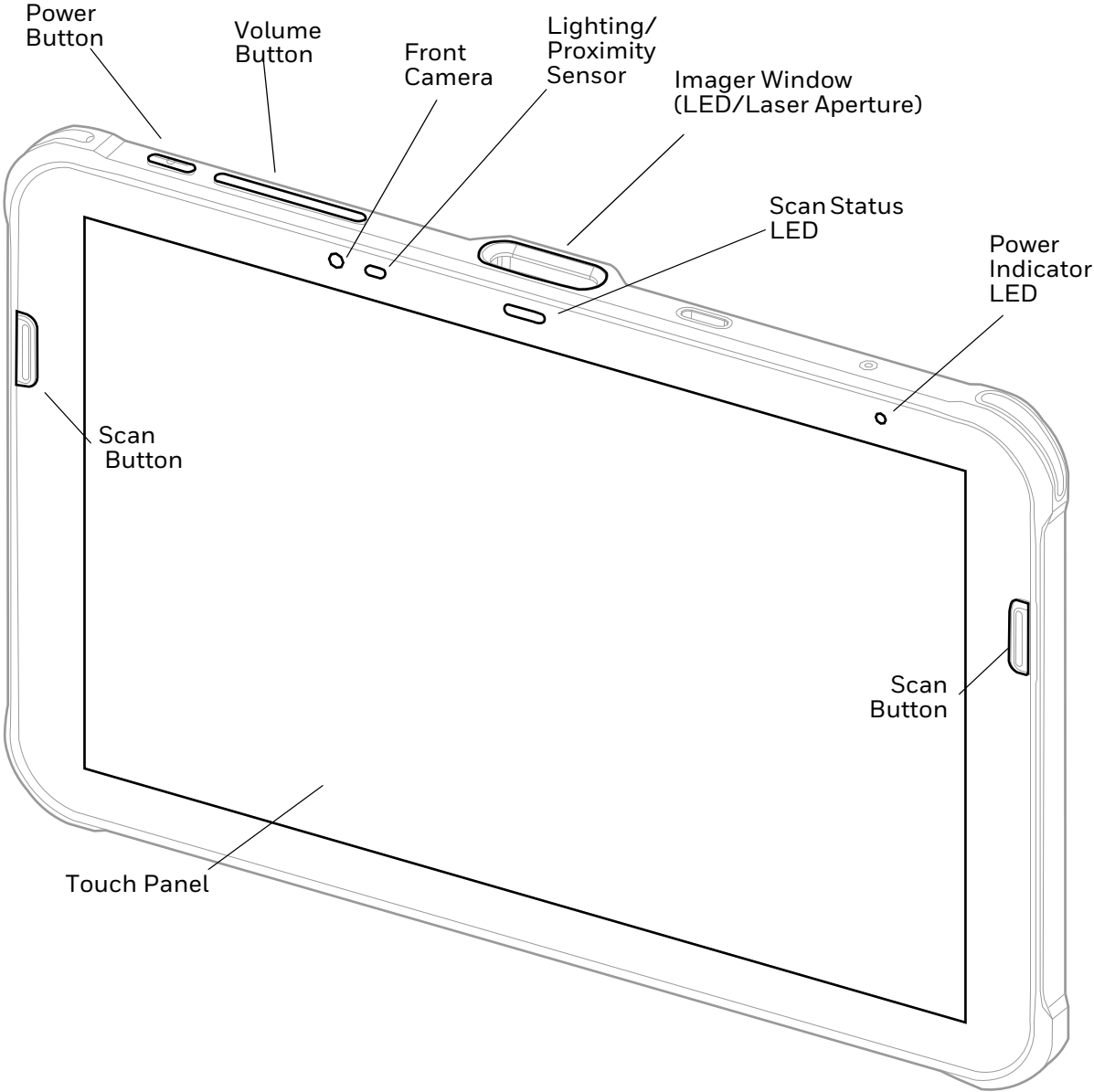

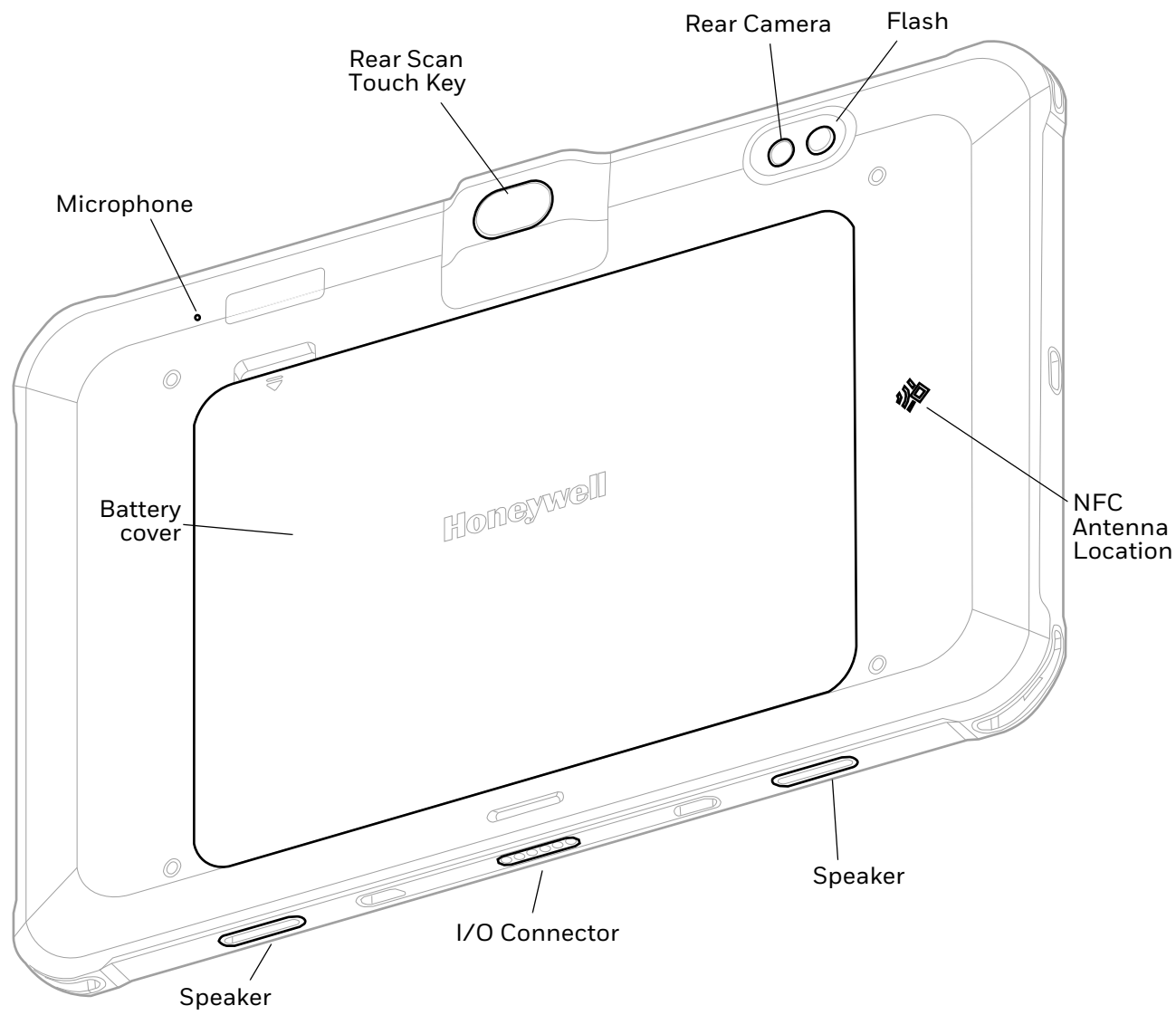

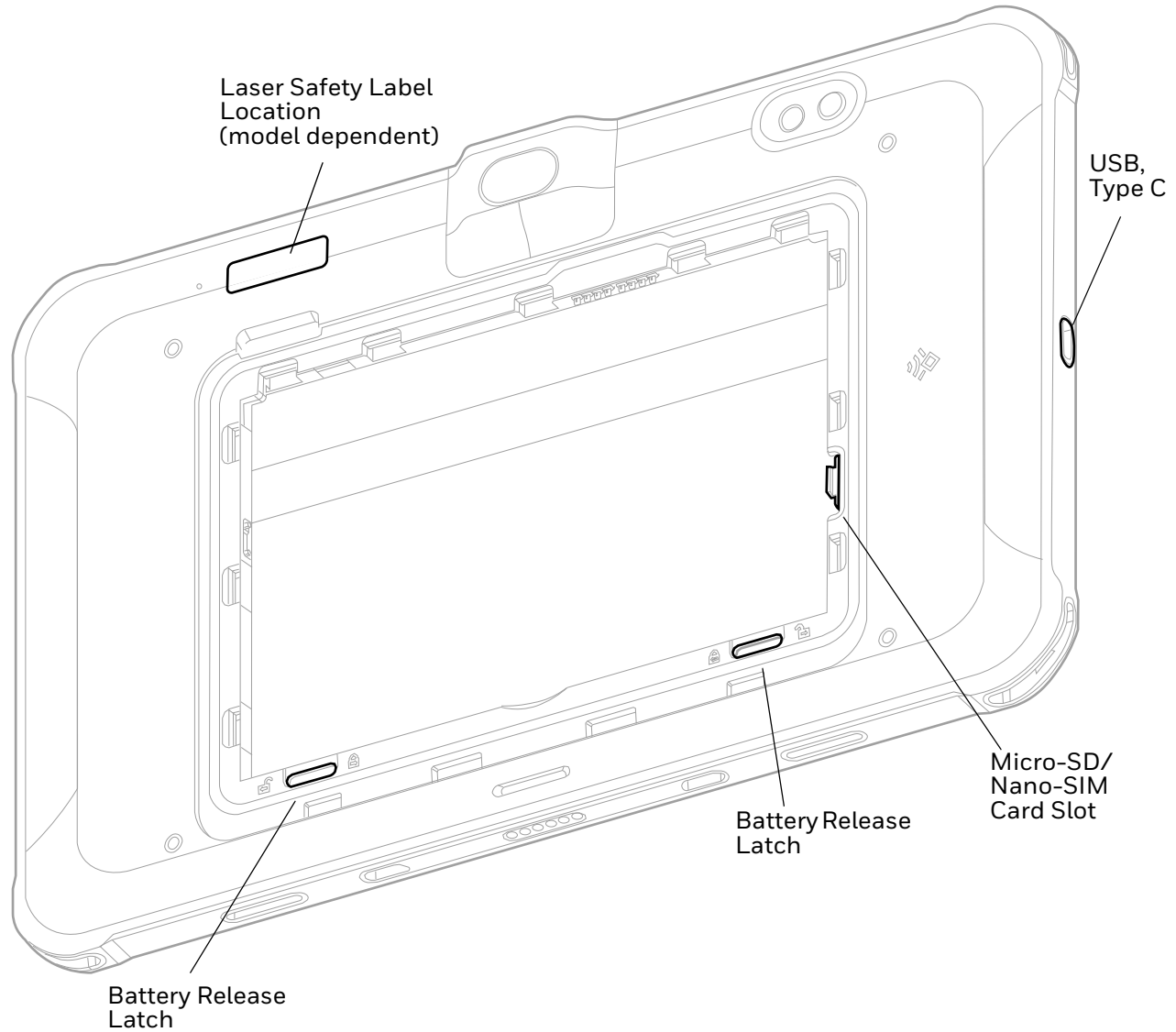

About the Battery

The tablet uses a rechargeable Li-ion battery as its main power source. Several factors determine the life of your battery, such as display brightness, display timeout, input device, extreme temperature, and usage. Honeywell recommends that you keep the battery charged at all times to prevent data loss.

EDA10A tablets are designed for use with battery model BAT-EDA10A manufactured for Honeywell International Inc.

Note: To view specifications specific to your battery model, see the battery insert supplied with the battery.

For more information about charging accessories, see the EDA10A *Accessories User Guide*, available on the EDA10A product page at sps.honeywell.com. Contact your local sales representative for replacement battery ordering information.



Caution: Improper battery replacement or incompatible device usage may result in risk of burns, fire, explosion, or other hazard. Dispose of lithium-ion batteries according to local regulations. Risk of fire and burns if improperly handled. Do not open, crush, heat above 60°C (140°F), or incinerate.

Charge the Battery

EDA10A tablets ship with the battery significantly discharged of power. Fully charge the battery before using your tablet for the first time. A fully discharged battery charges in approximately 5.5 hours.

Note: *Using the tablet while charging the battery increases the time required to reach a full charge.*

Charge the Battery Before Use

The mobile computer ships with a partially charged battery. Charge the battery with an EDA10A charging device for a minimum of 5.5 hours.

Note: *Using the computer while charging the battery increases the time required to reach a full charge.*

About the USB Type C Connector

You can use a USB cable to charge the mobile computer from a host device (e.g., laptop or desktop computer). The connected host device must supply a minimum power output of 5V, 0.5A to the mobile computer.

Note: *If the mobile computer is drawing more current than supplied by the charging source, charging will not take place.*

Battery Replacement

When battery power is low, you have the choice to either charge the battery in the tablet or replace it with another fully charged battery. Spare batteries can be purchased separately.



Caution: Ensure all components are dry prior to placing the battery in the computer terminal. Mating wet components may cause damage not covered by the warranty.

Before Attempting to Remove the Battery

Always do one of the following before removing the battery:

- Power off the computer.
- Press the Power button to turn off the LCD screen.

Hot Swap

You can replace the battery on demand provided the following conditions are met:

- The tablet has been powered on for at least 4 minutes.
- AND
- You insert a new battery within 30 seconds.

Note: *Before performing a hot swap, press the Power button to turn off the LCD screen. Leaving the LCD screen on during hot swap can reduce the time available to replace the battery.*

Battery Life Cycle

For batteries with part numbers 3012-0418-xxx, the EDA10A provides alerts about the life of the battery so that users can anticipate when to replace it. For part numbers 3012-0418-xxx, the lifespan of battery model BAT-EDA10A is 500 charging cycles. These batteries should be replaced with part number 3013-7979-xxx and 3012-0418-xxx.

Note: *In the battery part number, “xxx” refers to the series number, for example, -001,- 002, etc.*

- When the battery reaches 440 cycles, the tablet will display the following message: “Your battery is approximately 6 months away from the end of its designed life cycle. Your device will not power up at the end of the battery life cycle. Please contact your system administrator to obtain a replacement battery. Please click OK button to acknowledge.”
- When the battery reaches 500 cycles, the tablet will display the following message: “Your battery has reached its end of life. Your device will power off in 10 minutes. Please obtain a replacement battery from your system administrator. Please click OK button to acknowledge.”

The user can perform tasks on the tablet during the time before it shuts down, such as sending messages, syncing files, etc. At the end of the ten minutes, the tablet will power off.

Note: *The number of battery charge cycles per month is an estimate that will vary from user to user.*

Replace the Battery

Remove the Battery

1. Either power off the computer or press the Power button to turn off the LCD screen. See [Before Attempting to Remove the Battery](#) on page 6.
2. Release the hand strap, if applicable.
3. Pull the battery cover up at the notch then remove the battery cover from the unit.

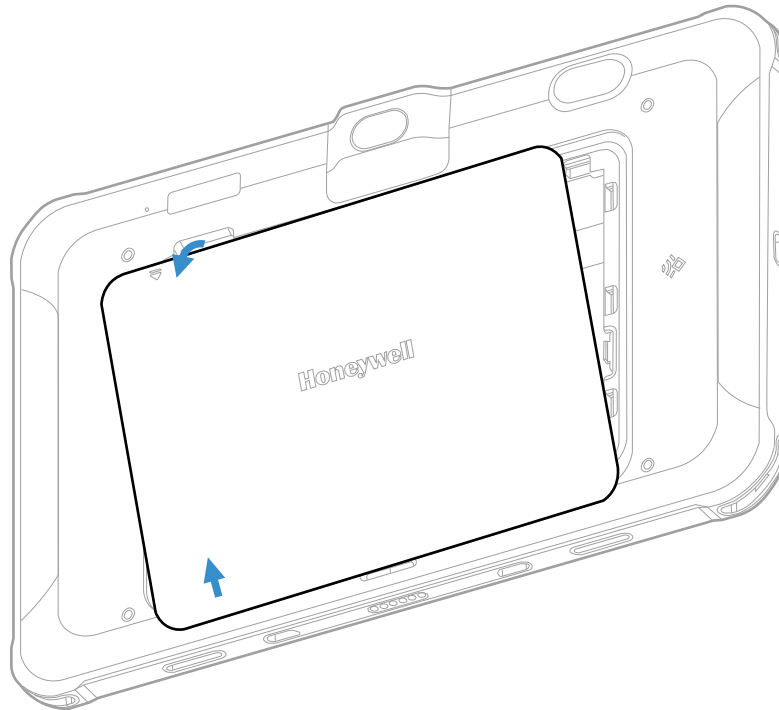

4. Slide the battery release latches to unlock the battery.

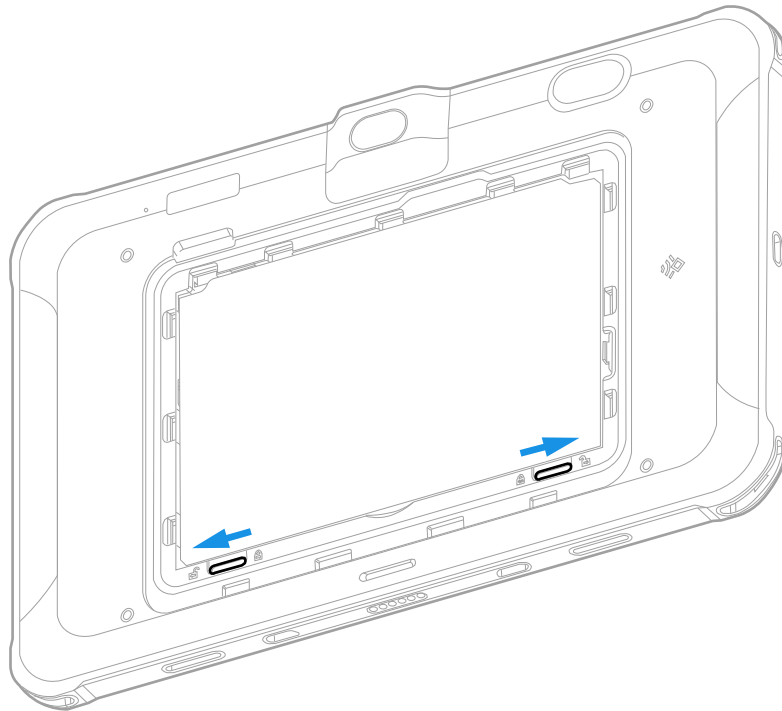

5. Pull up the tab on the back of the battery and use it to lift and remove the battery from the tablet.

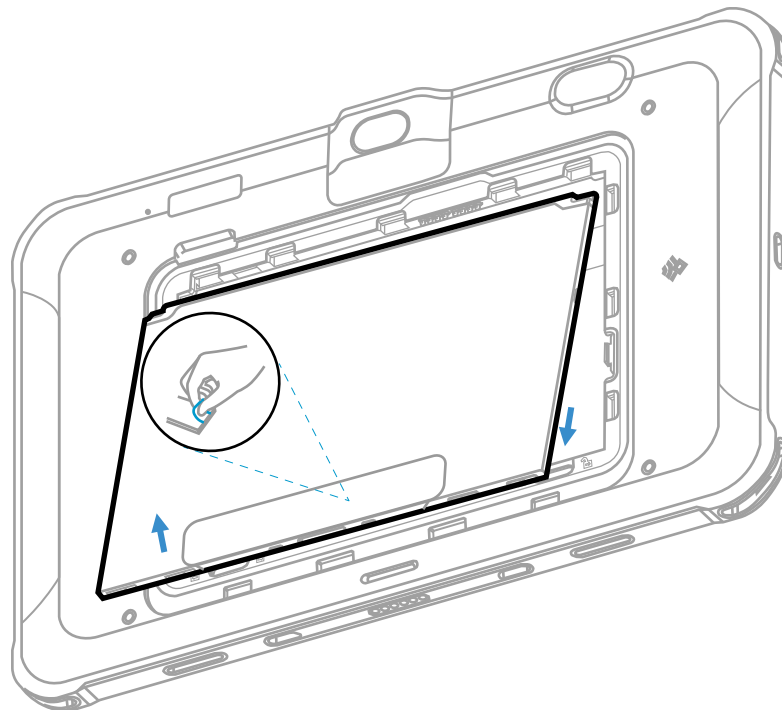

Install the Battery

- 1. Insert the charged battery into the computer.

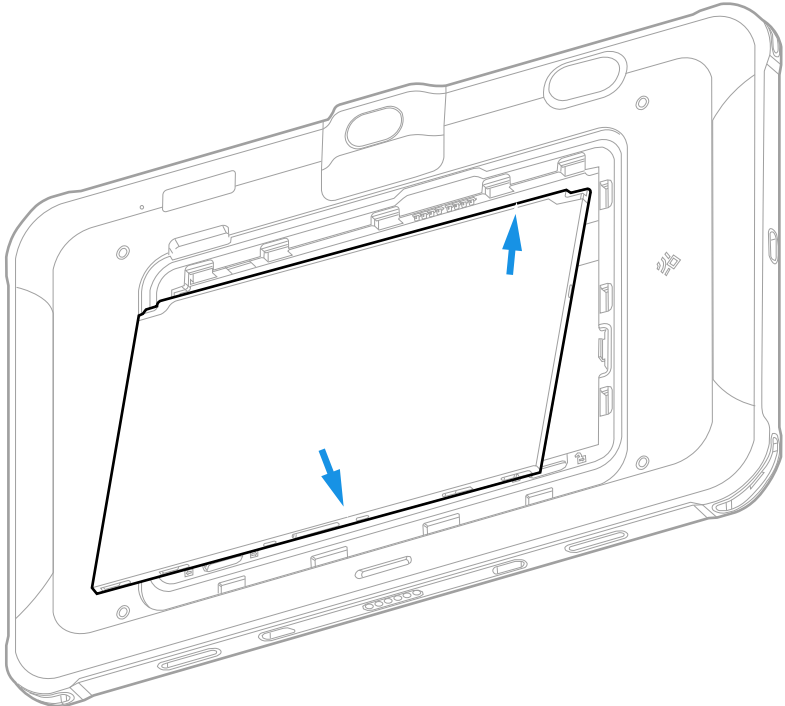

- 2. Slide the battery locks to secure the battery.

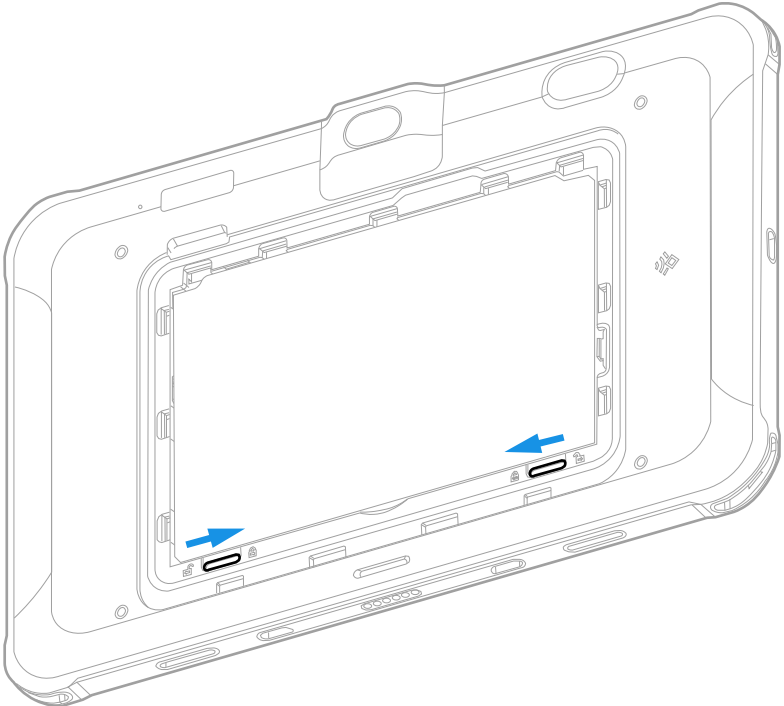

- 3. Install the battery cover.

4. Press the **Power** button.







About the Battery Status

To view detailed information on your battery, such as use statistics, amount of charge remaining, and battery health information:

1. Open the **Settings** app .
2. Select **Honeywell Settings > Battery**.

You can also use the battery icon at the top of the screen in the Status bar to see battery charge information. The icon changes depending on the charge level.

Battery Status Icons

Icon	Status
	The battery charge is at 100%.
	The battery charge is at 50%.
	The battery charge is low. You need to charge or replace the battery soon.
	The battery is critically low. You need to replace the battery now or connect the tablet to a charging accessory.
	The tablet is connected to external power and the battery is charging.
	There is a battery error. Install another battery. If the problem persists, contact Honeywell Technical Support.

Along with the battery icon, there is a battery status LED above the touch screen (see next section).

About the Battery Status LED Setting

You can change the behavior of the Battery status LED if the out-of-box behavior for a charging battery (blinking green) is not acceptable to your environment.

You can choose one of three options:

- **Default Battery LED** (optional Android OS configuration)
- **Honeywell Battery LED** (factory default, out-of-box configuration)
- **No Battery LED**

Honeywell Battery LED Behavior (Factory Default/Out-of-Box Configuration)

Connected to Power	LED State	Description
No	Blinking amber	Battery level is below 15%
No	Off	Battery level is more than 15%

Connected to Power	LED State	Description
Yes	Steady amber	Battery level is between 0% and 60%
Yes	Blinking green	Battery level is between 60% and 95%
Yes	Steady green	Battery level is above 95%
Either	Blinking red	Battery error

Default Battery LED Behavior (Optional Android OS Configuration)

Connected to Power	LED State	Description
No	Blinking red	Battery level is below 15%
No	Off	Battery level is 15% or more
Yes	Steady red	Battery level is below 15%
Yes	Steady amber	Battery level is between 15% and 90%
Yes	Steady green	Battery level is 90% or more

Select the No Battery LED setting if you want to use the LED as a notification LED for applications or device management solutions. For more information on how to use the LED as a notification LED, see <http://developer.android.com/guide/topics/ui/notifiers/notifications.html>.

Change the Battery Status LED Behavior

To change the battery status LED behavior:

1. Swipe up from the bottom of the Home screen to access all apps.
2. Tap **Settings**  > **Honeywell Settings** > **Battery LED**.
3. Choose one of the options:
 - **Default Battery LED** (optional Android OS configuration)
 - **Honeywell Battery LED** (factory default/out-of-box configuration)
 - **No Battery LED** (disable battery LED)

Check the Battery Level and Usage

In addition to the Battery status icon and LED, you can monitor the battery status from the Settings app.

1. Swipe up from the bottom of the Home screen to access all apps.
2. Tap **Settings**  > **Battery**.

The current percentage of battery power remaining and the amount of usage time left on the battery appear on the screen. A list shows the battery usage for individual apps and services. For usage details, select one of the apps or services in the list. You can also access the **Battery saver** feature from the battery screen.

Battery Life and Conservation

If you store the batteries outside the tablet for long periods of time, they slowly discharge. Honeywell recommends storing the battery in a charger to maintain battery performance.

When you want to:	Do this to save battery power
Use the tablet, and the battery status LED turns red	Connect the tablet to an external power source to charge. Or swap the battery for a fully charged one (see Hot Swap on page 7).
Stop using the tablet for 5 minutes or more	Press the Power button to suspend the tablet.
Store the tablet for more than a day	If you are storing the tablet for a few days (such as over the weekend), install a charged battery or connect the tablet to a power source. If you are storing the tablet for a longer period of time, fully charge the battery. When the battery is done charging, store both the battery and the tablet in a cool location. If you store the battery for several months, recharge the battery periodically to keep it at peak performance.
Store the battery outside the tablet	Store the battery in a charger.

Battery Recommendations and Safety Precautions



Caution: Improper battery replacement or incompatible device usage may result in risk of burns, fire, explosion, or other hazard. Dispose of lithium-ion batteries according to local regulations. Risk of fire and burns if improperly handled. Do not open, crush, heat above 60°C (140°F), or incinerate.

- To learn more about Battery Maintenance for Portable Devices, go to honeywell.com/PSS-BatteryMaintenance.
- For maximum battery life, charge the battery at 0 °C (32 °F) to 60 °C (140 °F) and store at 25 °C (77 °F) with a 30% charge.
- Do not store the battery pack at temperatures above 45 °C (113 °F). Storage above 45 °C (113 °F) may damage the battery pack.
- Charge the battery before use. Battery ships with a partial charge only.
- See [Charge the Battery](#), beginning on page 6 for approved charging methods. Use of this battery in other devices could result in damage to the device or battery.

- Avoid dropping the battery or computer. If you suspect that the battery or computer is damaged or if intermittent power and charging issues occur, send the relevant device(s) to a Honeywell service center for inspection of the computer and/or battery.
- Batteries should be replaced periodically, typically two years depending on the specific device.
- Replace the battery only with another BAT-EDA10A battery as identified below. These batteries have been tested in accordance with applicable safety standards. Contact your Honeywell sales representative or distributor if this battery is no longer available.

Model	Battery Part Number xxx = series number
BAT-EDA10A	3012-0418-xxx, 3013-7979-xxx

- Discarded batteries may create a safety hazard. Before disposal, cover the battery contacts with electrical insulating tape.
- Do not modify the battery or attempt to insert foreign objects into it.
- Do not solder directly to the battery contacts.
- Do not drop the battery or apply mechanical shocks or pressure to it.
- Do not immerse batteries into, or expose them to, water or seawater.
- Do not incinerate, microwave, throw into a fire, or expose batteries to temperatures above the maximum rating.
- Do not disassemble a battery or try to open or penetrate its housing.

Enable Airplane Mode

If you do not need to connect to any wireless networks, you can enable Airplane mode to turn Off the radios and save battery power.

1. Swipe up from the bottom of the Home screen to access all apps.
2. Tap **Settings**  > **Network & internet**.
3. Tap the toggle button next to **Airplane mode**. An airplane icon appears in the status bar to indicate Airplane mode is turned On.

Power On the Tablet

After you have fully charged and installed a battery, power on the tablet for the first time:

- Press and hold the **Power** button for approximately 3 seconds until the green LED power indicator lights up.



Caution: Do not press the power button repeatedly.



Caution: Do not attempt to connect or disconnect the AC adapter or press the tablet's screen, buttons or external keyboard/mouse until the tablet is powered up.

Welcome Screen

The first time you power on the tablet, a Welcome screen appears. Select a language and then tap **Start**. You can either scan a configuration barcode or select manual to set up the tablet. To learn more about how to [Scan Barcodes](#), see [page 42](#).

During the manual setup process, follow the prompts on the screen to:

- Set up the Wi-Fi network connections.
- Set the time, date, and time zone, if no Wi-Fi connection is available.
- Personalize (name) the tablet.
- Set up security and privacy options.

Once you complete the initial setup, the Welcome screen no longer appears when you power on the tablet and **Provisioning mode** is automatically turned Off (disabled). Scanning a barcode to install applications, certificates, configuration files, and licenses on the tablet is restricted when **Provisioning mode** is turned Off. To learn more [About Provisioning Mode](#) see [page 78](#).

Unlock the Screen

The screen lock automatically activates every time the tablet is turned On or when the tablet wakes from sleep mode.

- Swipe up from the bottom of the screen.

The level of security provided depends on the type of lock set (e.g., Swipe, Pattern, PIN, Password, or Face Unlock). The default setting, Swipe, provides no protection against unauthorized access to your tablet.

Unlock with Face Unlock

Use facial recognition with the front camera to unlock the computer in sleep mode.

1. Press the **Power** button to wake the computer.
2. While the bottom of the lock screen displays a smiling face, hold the front camera in front of your face until the computer unlocks.

If the computer does not recognize your face, a frowning face will display. To retry face unlock, tap the frowning face to display a smiling face.

Note: *When face unlock is enabled, you must use a PIN, pattern, or password to unlock the computer after it turns On or restarts.*

Change the Screen Lock to Protect the Tablet

After you start using the tablet, you should change the screen lock to prevent unauthorized persons from accessing the tablet after the screen lock activates, unless they input the correct password, pin, or pattern.

The recommended setting for the Screen lock is to enable a Password lock. Use a strong password value (e.g., include numbers, characters, special characters, and mix character case).

1. Swipe up from the bottom of the Home screen to access all apps.
2. Tap **Settings**  > **Security** > **Screen lock**.
3. Choose one of the following options:
 - **None**
 - **Swipe**
 - **Pattern**
 - **PIN**
 - **Password**
4. Follow the on-screen prompts to complete the setup.
5. Exit the Settings app.

Set Up Face Unlock

Face unlock allows you to unlock the computer in sleep mode by using facial recognition with the front camera. A series of on-screen prompts guide you through the process of capturing a face image that you can use to unlock the computer.

Note: When face unlock is enabled, you must also have a backup method to unlock the computer, such as PIN, pattern, or password.

1. Swipe up from the bottom of the Home screen to access all apps.
2. Tap **Settings**  > **Security** > **Face Unlock**.
3. If you have not set up a screen lock, you will be prompted to add a backup method for unlocking the computer: PIN, pattern, or password.
4. Follow the on-screen prompts to complete the setup.

You can add multiple face images. To add an additional face image, tap **Add face**.

Remove Face Unlock

To remove face unlock, you can delete all face images on the computer or remove the screen lock.

To remove a screen lock, see [Change the Screen Lock to Protect the Tablet](#) on page 16.

To delete all face images:

1. Swipe up from the bottom of the Home screen to access all apps.
2. Tap **Settings**  > **Security** > **Face Unlock**.
3. Enter the PIN, pattern, or password that is used as a backup method for unlocking the computer.
4. Tap **Remove face**.
5. Confirm that you want to delete all face images.

Select Glove Mode to Optimize Performance

If users wear gloves, select Glove Mode for the best touch screen response.

Note: Maximum glove thickness of 2 mm (0.08 inches) for touch screen response.

1. Swipe up from the bottom of the Home screen to access all apps.
2. Tap **Settings**  > **Honeywell Settings** > **Glove Mode**.

3. Tap the slider to turn Glove Mode on.
4. Exit the Settings app.

Configure the Screen Backlight

The display has an ambient light sensor that automatically adjusts the backlight intensity to conserve power and ensure the display is readable. You can also manually set the backlight intensity if you do not want to use the automated adaptive brightness feature.

1. Swipe up from the bottom of the Home screen to access all apps.
2. Tap **Settings**  > **Display**.
3. Choose one of the following options:
 - To have the tablet automatically adjust the brightness for your work environment, turn On the **Adaptive brightness** setting. You can tap **Adaptive brightness** to toggle the feature On or Off.
 - To set the brightness level manually, verify the Adaptive brightness feature is turned Off, and then select **Brightness level**. Adjust the slider to set the brightness level.

About the Audio Features

The EDA10A has multiple speakers, a microphone, and several software tools to configure sound volume or enable vibration feedback.

Audio Settings

This section describes the audio and sound settings you can configure in the Settings app.

- To change audio settings, select the **Settings** app  and then tap **Sound**.

Note: *Sound settings are model dependent. Some settings may not be available for your model type.*

Sound Settings

Setting	Description
Media volume	Use the sliders to set the volume for media (e.g., music, videos, and games), alarms and rings (notifications and ringtones).
Call volume	
Ring & notification volume	
Alarm volume	

Setting	Description
Do Not Disturb	Configure the Do not disturb feature.
Phone ringtone	Set the default sound for phone calls.
Media	Show media player in Quick Settings.
Vibrate for calls	Choose the vibration option when a call is received.
Default notification sound	Set the default sound used for notifications.
Default alarm sound	Set the default sound used for alarms.
Dial pad tones	Turn dial pad tones on or off.
Screen locking sound	Enable or disable an audio tone when the screen is locked
Charging sounds	Enable or disable an audio tone when the computer is charging
Touch sounds	Enable or disable audio sounds when you use the touch screen.
Touch vibration	Enable or disable haptic feedback when tapping the screen

Adjust Volume

During playback you can adjust the volume using the Volume button on the top of the tablet.



Warning: To avoid possible hearing damage, do not listen at high volume levels for long periods.

Install a Micro SIM Card

Only EDA10AL1N (WWAN) models support micro SIM card use for cellular phone features. Either a nano-SIM card or embedded SIM (eSIM) is used to activate the phone and connect to a mobile network. eSIM is available on select models only. Refer to the user guide for additional information.

Note: Always power off the tablet before attempting to install or remove a card.

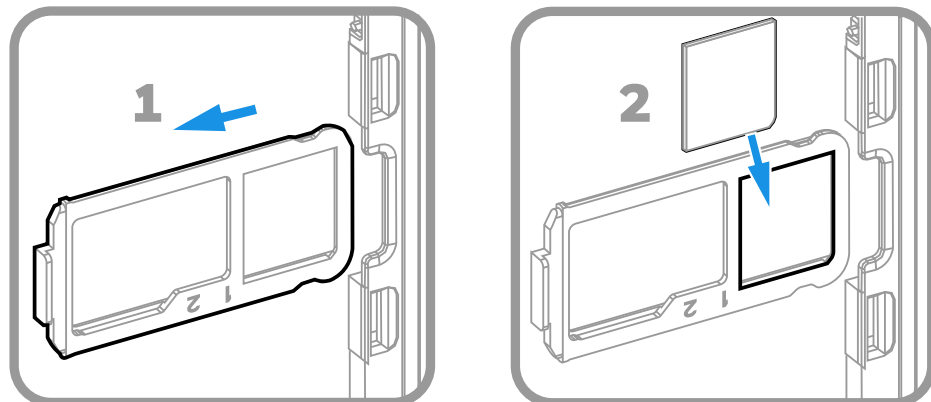

Insert a microSD Card (Optional)

You can use a microSD card to increase file storage capacity or to install software. Honeywell recommends the use of Single Level Cell (SLC) industrial-grade microSD™ or microSDXC™ memory cards with EDA10A ScanPal Enterprise Tablets for maximum performance and durability.

Note: Format memory card before initial use.

Note: Always power off the tablet before attempting to install or remove a card.

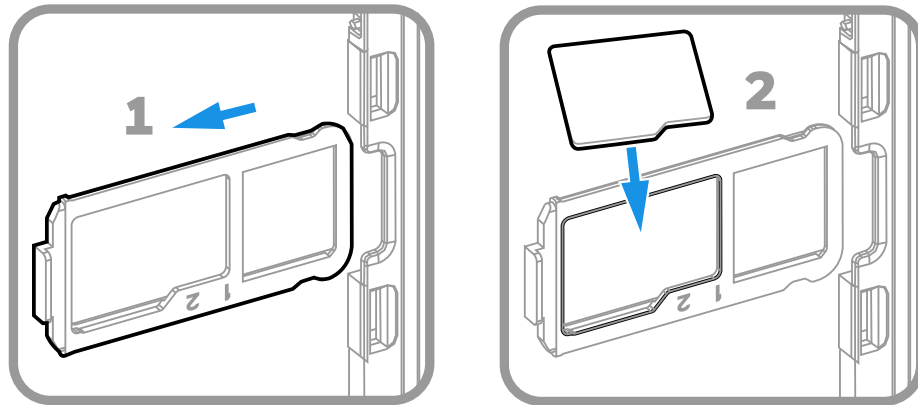

How to Transfer Files

To transfer files you need to physically connect the EDA10A mobile computer to your workstation (e.g., laptop or desktop computer) through a USB connection. When the tablet is connected and USB is configured for file or photo transfer, use a file browser (e.g., File Explorer or Windows Explorer) on your workstation to transfer files between the two computers. If you are transferring files to and from a Mac, use the Android File Transfer application (available from www.android.com/filetransfer).

Note: File transfer through a USB connection is disabled by default. You need to configure the USB connection for transferring files or photos.

You can use a standard USB cable to connect your tablet to your workstation.

Configure USB Connection and Transfer Files

Note: The EDA10A supports Hi-Speed USB communications (USB 3.0) with a maximum data transfer rate of 640 Mbps.

1. Connect the EDA10A to your workstation.
2. On the EDA10A, swipe down from the top of the screen to see the notifications.
3. Tap the **Android System** notification twice to open the options menu.

4. Select either **File Transfer** or **PTP**.
5. Open the file browser on your workstation.
6. Browse to the EDA10A. You can now copy, delete, or move files between the EDA10A and your workstation.

Note: When Provisioning mode is disabled (turned off), some file folders are hidden from view in the file browser.

Accessories for the EDA10A

The EDA10A ships with a standard battery and USB Type-C cable. All other accessories are ordered and shipped separately.

For more information about charging, communication and mounting accessories, see the EDA10A *Accessories User Guide*, available on the EDA10A product page at sps.honeywell.com.

For ordering information and a list of all available EDA10A accessories, contact your local sales representative.

Accessory	Part Number
x = Kit variations. See Product Accessory Guide at sps.honeywell.com for additional details.	
Single Charging Dock	EDA10A-SC-R
Display Dock	EDA10A-DB-x
Quad Battery Charging Base	EDA10A-QBC-x
Quad Bay Charging Base	EDA10A-CB-x
Vehicle Dock	EDA10A-VD-USB
Protective Boot	EDA10A-RB-0
Rotating Hand Strap	EDA10A-HS-1PK
Shoulder Strap	EDA10A-SS-1PK
Protective Screen Film	EDA10A-SP-1PK
Carrying Case	EDA10A-CASE
Stylus & Tether	EDA10A-STL-1PKC
VESA Mount Plate	EDA10A-MNT-VS
Adapter cup to use EDA10A-SC or EDA10A-DB without rubber boot	EDA10A-ADC

ABOUT THE USER INTERFACE AND APPLICATIONS

Use this chapter to learn about the user interface and how to interact with the screen. You can also use this chapter to learn about the Honeywell applications on the computer.

About the User Interface

The Android operating system provides a touch-friendly and easy-to-navigate user interface. When you turn on the mobile computer, the Home screen is the first screen that appears after language provisioning and the startup Wizard is complete.

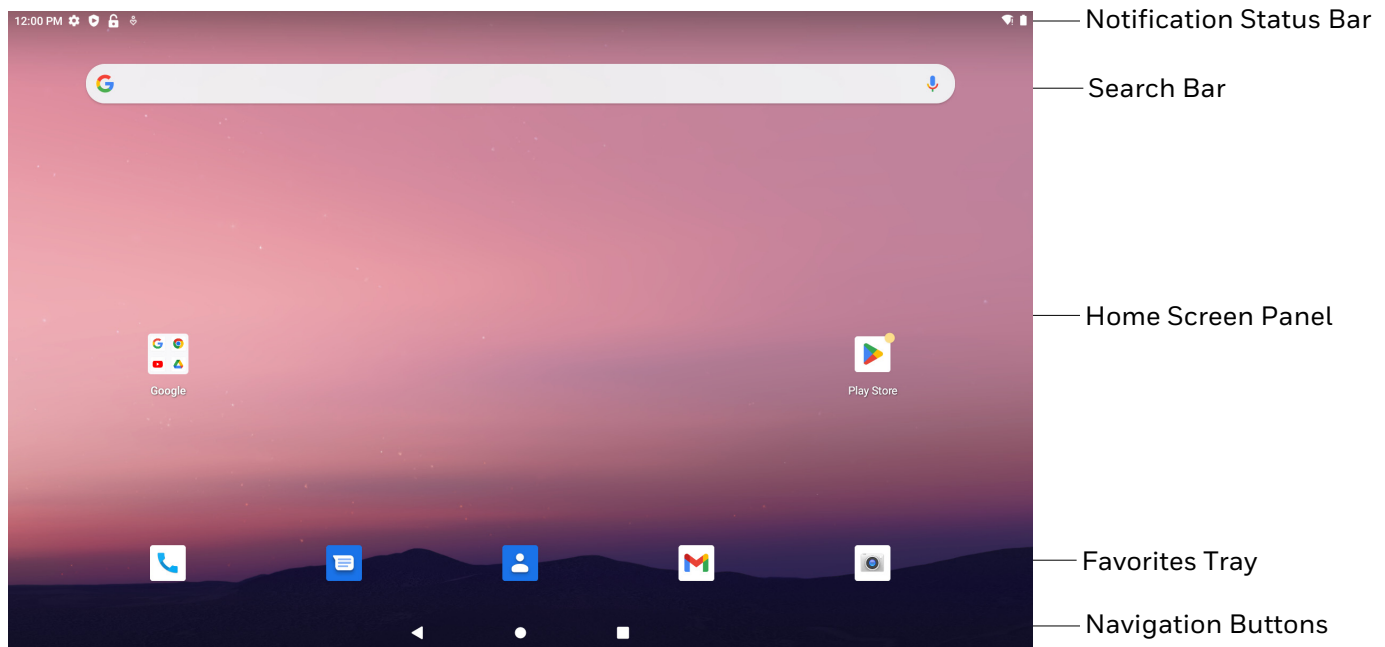

Home Screen Features





Item	Description
Notifications panel / Status bar	Status icons to the left tell you when an app has sent notifications, such as an arriving message. System icons to the right display the current wireless and network connection state and battery level.
Search bar	Search the Internet or the computer using Google™. Touch the microphone icon in the search box to initiate a voice search or command.
Home Screen panel	You can create more than one custom Home screen panel. Swipe left or right on the Home to switch between your custom panels.
Favorites tray	App icons in the customizable tray are visible on all Home screen panels.

Navigation and Function Buttons

Your mobile computer has virtual buttons on the front panel below the Favorites tray and hardware buttons located on the sides for easy navigation and quick feature access when using the computer.

For button locations on the computer, see [Tablet Features](#) on page 3.

Navigation and Function Buttons

Button	Description	
	Back	Return to the previous screen.
	Home	Return to the Home screen.
	Recent Apps	View and switch between recently used apps.
	Front Scan Buttons	Press the right or left scan button to trigger the scanner.
	Rear Scan Touch Key	Touch the rear scan key to trigger the scanner.

Enable the Rear Scan Touch Key













By default, the Rear Scan Touch Key is turned off. To turn on the Rear Scan Touch Key, use one of these options:

- Navigate to **Settings > Honeywell Settings > Touch Key** and turn on **Touch Key Switch**
- Swipe down from the top of the screen and tap **Touch Key**.

About Status Bar Icons

Status and notification icons show you the current status of your network, the battery, notifications, and sounds. Use the table below to understand some of the most common icons.

Status and Notification Icons

Icon	Description	Icon	Description
	Pending alarm and Alarm is set		Airplane mode is turned On.
	New text message or multimedia message		Bluetooth is turned On.
	Error with text or multimedia message delivery		SD card is full
	New email		Wi-Fi network connected with full signal strength
	Computer is connected to a PC with a USB cable		Wi-Fi network connected but no signal strength
	Synchronizing data		Error with sync or sign-in
	Computer is connected with Ethernet		

Remap a Button or Key

You can change the default function of the Left Scan, Right Scan, Rear Scan, Volume Up, and Volume Down buttons as well as the Back, Home, and Recent virtual buttons.

1. Swipe up from the bottom of the Home screen to access all apps.
2. Tap **Settings**  > **Honeywell Settings** > **Keyremap**.
3. Tap the plus sign (+).
4. Press the button you want to remap or select one of the virtual keys.
5. Tap **OK**.
6. Select one of the following options:
 - Tap **Keys** to view available functions. Select the function you want assigned to the button.
 - Tap **Apps** to view available applications. Select the application you want assigned to the button.
 - Tap **Actions** to enter an Intent or Broadcast. Tap **OK** to assign the action to the button. For example, to send a Broadcast,

android.intent.action.MASTER_CLEAR, or to start an Intent, com.android.settings/com.android.settings.wifi.WifiSettings.

- Tap **Command** to enter a command that will be executed when the button is pressed. This option supports all ADB shell commands. For example, if you choose a button to remap and enter the command “input keyevent 64”, pressing the selected button will open the web browser on the device.
- Tap **Text** to type characters to display when the remapped key is pressed. Use a comma “,” to separate the characters. Tap **OK** to assign the text to the button. Examples are listed below:



Input Text	Button Press
A,A,B	aab
SHIFT_LEFT,A,SHIFT_LEFT,B or CAPS_LOCK,A,CAPS_LOCK,B	AB
SHIFT_LEFT,1	!
CTRL_LEFT,A	(Select All)
VOLUME_UP	(Volume Up)

Note: Lower case text is not supported in the **Text** field. Text must be entered in upper case. For example, “H,e,l,l,o” will display as “h”, whereas “H.E.L.L.O” will display as “hello”.

7. The function you selected now appears next to the button name.

Restore Default Button Action

To restore the button default action:

1. Swipe up from the bottom of the Home screen to access all apps.
 2. Tap **Settings**  > **Honeywell Settings** > **Keyremap**.
 3. Tap the clean icon .
 4. Choose the remapped button(s) you want restored to the default setting.
 - Tap the check box next to the button.
- OR
- Tap **All Select** to choose all the buttons.
5. Tap **Delete**.

View and Manage Notifications

You can view recent events on the computer, manage system notifications, change a setting or quickly respond to an app notification by opening the notifications panel.

When a notification icon appears in the status bar at the top of the screen:

1. Swipe down from the top of the screen to open the notifications panel.
2. Respond to the notification. You can take one of the following actions:
 - Tap the notification to open the associated app.
 - Tap a quick-reply or action command (e.g., Reply, Archive), if available.
 - Swipe the notification sideways, off the screen to dismiss it.Slide the notification left or right to reveal the settings icon . Choose between Default and Silent.

Note: *Some notifications cannot be dismissed or turned Off.*

To close the notification panel, swipe up from the bottom of the screen, or tap the Back or Home buttons.

Open Quick Settings

Use the Quick Settings screen for easy access to common settings. Tap an icon to toggle the feature On/Off or to open additional settings.

- To open Quick Settings, swipe down twice from the status bar at the top of the screen.
- To close Quick Settings, tap the Back or Home buttons.

Customize the Home Screen

You can add application icons to any Home screen for easier access.

1. Swipe up from the bottom of the Home screen to access all apps.
2. Tap and hold the app you want to add, and then start to drag the icon out of position. The computer switches to a smaller view of the Home screen panel.
3. Drag and drop the app icon into place.
 - If you want to add another home screen, drag the icon to the right edge of the screen before releasing the icon.
 - If you want to create a folder, drag and drop the icon on top of another icon.

Note: *If you tap and hold an app but don't move it, a shortcut menu appears. The content of the menu depends on the app selected.*

To add widgets or customize the look of the Home screen:

1. Tap and hold an empty section of the screen.
2. Select either **Home settings**, **Widgets**, or **Wallpapers**.

Customize the Favorites Tray

Modify the Favorites tray to contain the apps you use the most.

1. Tap and hold the app icon you want to replace on the Favorites tray.
2. Drag and drop the app on “**X Remove**” at the top of the screen.
3. Swipe up from the bottom of the screen to access all apps.
4. Tap and hold the icon of the app you want to add.
5. Drag and drop the icon into position on the Favorites tray.

Use Google™ Search

Use the Google Search field to help you find anything you need on the computer or on the web.

1. On the Home screen, tap inside the Google Search box and begin to type your search term.

As you type, suggestions from Google web search appear below the Search box, and results from the computer (such as apps or contacts) appear below the web search results.

2. Tap a suggestion to search for it immediately, or touch the arrow to add the term to the search field without starting to search.

About Screen Gestures

Use your fingers to manipulate icons, buttons, menus, and other items on the screen.

- **Tap**

Tap to select something, toggle a setting On or Off, or activate a field for text entry.

- **Tap and hold**

Tap and hold an item but do not lift your finger until an action occurs.

- **Drag and drop**

Tap and hold an item, and then slide your finger across the screen until you reach the target position. Lift your finger off the screen to drop the item in place.

- **Swipe**

Quickly move your finger across the screen, without pausing when you first touch. For example, you can swipe a Home screen left or right to view the other Home screens.

- **Slide**
Slowly move your finger across the screen, without pausing when you first touch. For example, you can slide a notification to the left until the Settings gear is revealed.
- **Double-tap**
Tap quickly twice on a web page, map, or other screen to zoom in. Double-tap again to zoom out.
- **Pinch**
In some apps, you can zoom in and out by placing two fingers on the screen at once and pinching them together (to zoom out) or spreading them apart (to zoom in).

Set the Time Zone

The computer gets the current date and time from its network connection. If preferred, you can change this behavior and manually set the time zone for your location.











1. Swipe up from the bottom of the Home screen to access all apps.
2. Tap **Settings**  > **System** > **Date & time**.
3. Tap **Set time automatically** to turn Off the feature.
4. Tap **Time zone** and choose the time zone for your location.

About Honeywell Applications

Honeywell applications help you troubleshoot and connect your computer to other devices and networks. Some of the applications in this table are located in the Power Tools app. To learn more about Honeywell Power Tools, go to sps.honeywell.com to download the *Power Tools User Guide*.

Honeywell Applications Available on the Computer

Icon	Application	Description
	AutoInstall Settings	Enable the AutoInstall feature, to automatically install *.zip or *.apk files containing applications saved in the Internal shared storage\honeywell\autoinstall folder and IPSM card\honeywell\autoinstall folder on the computer during the power-up boot or reboot process.

Icon	Application	Description
	Demos	Honeywell Demo apps demonstrate the basic capabilities of the computer and are not intended as functional business solutions. The demos included, demonstrate scanning, signature capture, NFC functionality, and printing via Bluetooth technology. Information on how to create custom applications for your Honeywell mobile computer can be found in the Honeywell Software Development Kit (SDK) for Android, available from the Technical Support Downloads Portal .
	HUpgrader	Use the Honeywell Upgrader app (HUpgrader) to automatically search for and install Over-the-Air (OTA) operating system updates from a remote server.
	Scanner Edge	Use the Scanner Edge app to connect or disconnect a Bluetooth scanner. <ul style="list-style-type: none"> • View connected devices. • Pair with a Bluetooth Scanner. • Disconnect a Bluetooth Scanner.
Power Tools		
	BattMon	BattMon provides information on the charge status and health of the battery, and provides access to activate battery status notifications and battery charging history logs.
	ConfigApps	ConfigApps enables or disables applications and application updates.
	Configure Autorun	Configure Autorun provides the ability to set applications to automatically run after a reboot.
	Diagnostic Information	Diagnostic Information provides access to system statistics, notifications and version information about the computer.
	EZConfig	EZConfig supports advanced customization and configuration of the handheld computer. EZConfig includes a standard XML editor and configuration barcode scanner feature.
	WiFi Diagnostic	Use application to: <ul style="list-style-type: none"> • View Wi-Fi radio status information about a connected access point or a list of other available access points in range of the Wi-Fi radio. • Use the Route utility to view packet destination gateway information across the subnets. • Use the IPConfig utility to view IP parameters for the on-board network adapters. • Use the Ping utility to verify communication links or to make sure a specific IP address is working.
	Wireless Tether	Use to enable range tracking and customize out-of-range alerts for Bluetooth devices paired and tethered to your hand held computer.

Applications You Can Download to the Tablet

You can download Honeywell applications to extend the capabilities of the tablet. You may need to purchase a license to run some applications. To learn more about the applications described in this section and other Honeywell software solutions, go to sps.honeywell.com and click **Software > Productivity**.

About Honeywell Enterprise Browser

Enterprise Browser for Microsoft® Internet Explorer® is a locked-down enterprise Web client application designed for Honeywell computers. It provides a controlled Web application environment that helps enterprises increase productivity and reduce IT management expenses. You can configure Enterprise Browser for your specific application requirements and design custom web applications that run through the Enterprise Browser to provide your users with an easy-to-use yet controlled experience.

If Enterprise Browser is not included on your computer model, you can download a trial version for evaluation. After the evaluation period expires, you need to purchase a license. For more information about Enterprise Browser, visit sps.honeywell.com.

About Honeywell Launcher

Launcher is a configurable locked-down menu program designed for Honeywell computers that prevents end-users from accessing the start menu and other non-authorized applications. Use Launcher to provide a platform where your mobile computer users are limited to running only company-approved applications and prevent them from initiating unauthorized configuration changes. You can also use Honeywell Launcher together with Honeywell Enterprise Browser to create a single-purpose device configuration.

If Launcher is not included on your computer model, you can download a trial version of the software for evaluation. After the evaluation period expires, you need to purchase a license. For more information about Launcher, visit sps.honeywell.com.

About Terminal Emulators

Honeywell offers several terminal emulator solutions that allow users to manage their mobile devices by providing reliable data transfer between the host mobile device and terminal. Terminal emulators can be used for remote management and configuration of devices, data collection and analysis, and session management.

Depending on the computer model, a terminal emulator may come preinstalled on the device. If a terminal emulator is not included on your model, you can download a trial version for evaluation. After the evaluation period expires, you need to purchase a license. For more information, visit sps.honeywell.com.



About UEMConnect

Honeywell UEMConnect enables customers to use the Google OEMConfig protocol to perform enterprise configuration and enhance the management of Honeywell ScanPal EDA Series devices. It seamlessly integrates with EMM solutions to expose Honeywell management extensions directly on the EMM console. UEMConnect provides exclusive access to over 260 advanced Honeywell proprietary settings and provides supplemental access to standard EMM features. EMM providers may also make use of generic Android APIs to provide standard EMM functionality.

Honeywell UEMConnect is available for download in the Google Play™ store. UEMConnect licenses are included with the purchase of applicable SOTI offerings through Honeywell or may be purchased separately for applicable EMM solutions not purchased through Honeywell.

Unlock Developer Options

Developer options only appear in the Settings app if you unlock the feature. If you are a developer working with the computer, you can easily unlock the additional settings to use for testing and debugging applications under development for the computer.

1. Swipe up from the bottom of the Home screen to access all apps.
2. Tap **Settings**  > **About phone**.
3. Tap **Build number** seven times. A message appears informing you that you are now a developer.
4. Tap **Developer options** under **Settings**  > **System**.

USE THE IMAGE ENGINE

Use this chapter to understand how to scan barcodes, configure the scan settings, and capture images using the integrated image engine in the computer.

If your EDA10A Enterprise tablet does not have the integrated image engine, you can use the rear camera on the device to scan barcodes. See [Scan Barcodes with the Rear Camera](#) on page 42 for more information.

About the Image Engine

You can use the image engine in the computer as a scanner or camera.

Use the imager as a scanner to read 1D and 2D barcode symbologies, composite symbologies, and postal codes. It also supports omni-directional scanning for greater flexibility in real-world settings. By default, the scanner feature is enabled and uses the default scan profile. You can modify the Default Profile or create new profiles for custom applications from **Settings > Honeywell Settings > Scanning**.

Use the imager as a camera to capture black and white images, such as signatures or pictures of damaged inventory. The imager camera feature requires the development of a custom application that uses the Honeywell Mobility SDK for Android. To download the Honeywell Mobility SDK for Android, see [Developer Information](#) on page 78.

Note: *Instead of using the internal imager, you can also use Bluetooth communications to connect the computer to an external scanner, such as the Granit™ 1990i and 1991i.*

About the Scan Wedge Feature

The scan wedge feature sends scanned barcode data to an active application as Android keypad input. To scan a barcode as keyboard input, open an application that accepts text input and then scan a barcode. You can use applications that are coded to use the scanner or applications that receive data through the scan wedge feature. If an application claims the scanner through the BarcodeReader API, the scan wedge feature is temporarily disabled.

You can find information on how to create custom applications for the computer in the *Software Development Kit (SDK)* available for download from the *Technical Support Downloads Portal* at <https://hsmftp.honeywell.com>. Once you create an account and enter the portal, navigate to **Software > Software and Tools > Developer Library > SDKs for Android**.

Change the Scanner Settings

Changes you make to the Default profile apply to all applications with no profile assigned.

1. Swipe up from the bottom of the Home screen to access all apps.
2. Tap **Settings**  > **Honeywell Settings** > **Scanning**.
3. Tap **Internal Scanner** > **Default profile**.
4. Select from the following:
 - **Data Processing Settings**,
 - **Symbology Settings**,
 - **Decode Settings**,
 - **Imager Settings**,
 - **Trigger Settings**, or
 - **Notification Settings**.
5. Modify the settings to meet your application needs.

To learn more about the scanner settings, [Default Scan Settings](#) on page 35.

Restore Default Scan Settings

You can easily discard all changes you made to the Default profile and restore the default values.

Note: *When you choose the Restore all defaults option from any of the settings screens in a profile, all the settings in that profile return to their default values.*

1. Open the **Default profile**.
2. Tap  in the upper right corner of any of the scan settings screens for the profile.
3. Tap **Restore all defaults**.

Default Scan Settings

Use the following sections to understand the scan settings available for scanner profiles. To learn how to create a new profile, see page [41](#).

Data Processing Settings

Use the Data Processing Settings to specify how barcode data is processed by the computer.

Data Processing Settings

Setting	Description	Default										
Wedge	Enable or Disable the scan wedge feature.	Enabled										
Wedge Method	Standard or Keyboard.	Standard										
Charset	Select the character set to use when interpreting the barcode data into a string.	ISO-8859-1										
Prefix	<p>Defines the string added before the decoded barcode data. Substitutions occur within the Prefix string values.</p> <table border="1"> <thead> <tr> <th>Substring</th> <th>Replacement Character Code</th> </tr> </thead> <tbody> <tr> <td>\r</td> <td>13</td> </tr> <tr> <td>\n</td> <td>10</td> </tr> <tr> <td>\t</td> <td>9</td> </tr> <tr> <td>\\</td> <td>'\'</td> </tr> </tbody> </table>	Substring	Replacement Character Code	\r	13	\n	10	\t	9	\\	'\'	None
Substring	Replacement Character Code											
\r	13											
\n	10											
\t	9											
\\	'\'											
Suffix	<p>Defines the string added after the decoded barcode data. Substitutions occur within the Suffix string values.</p> <table border="1"> <thead> <tr> <th>Substring</th> <th>Replacement Character Code</th> </tr> </thead> <tbody> <tr> <td>\r</td> <td>13</td> </tr> <tr> <td>\n</td> <td>10</td> </tr> <tr> <td>\t</td> <td>9</td> </tr> <tr> <td>\\</td> <td>'\'</td> </tr> </tbody> </table>	Substring	Replacement Character Code	\r	13	\n	10	\t	9	\\	'\'	None
Substring	Replacement Character Code											
\r	13											
\n	10											
\t	9											
\\	'\'											
Wedge as keys	List of character values to wedge as keys, represented as a comma-separated list of decimal values.	9,10,13										
Data Editing Plugin	Specify a data editing plug-in and edit plug-in settings.	None										
Symbology Prefix	<p>Specify a symbology identifier prefix to the barcode data. Options include:</p> <ul style="list-style-type: none"> • None • Honeywell • AIM 	None										

Setting	Description	Default
Launch Browser	<p>Enable or disable URL barcode handling. If a barcode starts with http:// or https://, the browser opens using the barcode data as a URL.</p> <p>Corresponds to BarcodeReader property: PROPERTY_DATA_PROCESSOR_LAUNCH-BROWSER</p>	Enable
Scan to Intent	<p>Enable or disable special handling of scan-to-intent barcodes.</p> <p>Applies to barcodes in one of the following formats: '//' ACTION '//' ACTION '\$' extra-data</p> <p>Where: ACTION and extra-data are any string of characters.</p> <p>Launches an application listening for the intent. Intent action: "com.honeywell.scantointent.intent.action." + ACTION Intent extra: "com.honeywell.scantointent.intent.extra.DATA" contains the remainder of the barcode data after the first '\$' character.</p> <p>Corresponds to BarcodeReader property: PROPERTY_DATA_PROCESSOR_SCAN_TO_INTENT</p>	Enabled
Launch EZ Config	<p>Enable or disable special handling of EZConfig barcodes.</p> <p>Applies to EZConfig barcodes that are encoded with the Aztec symbology and contain specific header data.</p> <p>Corresponds to BarcodeReader property: PROPERTY_DATA_PROCESSOR_LAUNCH_EZ_CONFIG</p>	Enabled
Data Intent	<p>Enables the reception and processing of barcode data without using an SDK or library.</p>	Disabled

Symbology Settings

Use the Symbology Settings to enable or disable barcode symbologies for the selected scan setting profile.

- Tap the check box next to a symbology name to enable (check mark) or disable (no check mark) decoding for that symbology.
- Tap the symbology name to view and modify additional configuration parameters for the symbology selected.

To view a list of default settings for supported symbologies, see [page 86](#).

Decode Settings

Adjust the Decode Settings when scanning barcodes that are densely packed or poor quality.

Decode Settings

Setting	Description	Default
Center Decode	<p>When enabled, the imager scans and decodes a barcode only if part of the barcode is at the center of the aimer window. This is useful in situations where several barcodes may be very close together in the imager field-of-view.</p> <ul style="list-style-type: none"> • Tap the check box to toggle the feature On or Off. • Select Center Decode to adjust the Center Decode Timeout and the Window dimensions. <p>Honeywell recommends leaving the settings at 50 (default) to define the “center” area for the barcode.</p> <p>Configurable parameters:</p> <ul style="list-style-type: none"> • Window top • Window bottom • Window left • Window right 	Disabled
Decode Security	Use this setting to control the reading tolerance of the decoder. Lower settings are more lenient when reading low quality barcodes while higher values are more strict.	2
Decoder timeout	Set the amount of time in milliseconds that the scanner will timeout if a readable barcode is not found.	150
Decode Filter	<p>Use this setting to modify or reject data strings.</p> <ul style="list-style-type: none"> • Decode filter script The decode filter script is used to configure a filter for decode results during scanning. For example, a filter could be used to reject barcodes that don't begin with certain characters, remove leading characters (like “00”) from the beginning of a barcode, or only scan barcodes that begin with certain characters. • Decode filter timeout (ms) The decode filter timeout option can be used to disable the logic inside the filter script after a given amount of time. • Debug level Set the filter information level. The default level is 0, no information. Higher levels emit more information. Level 4 emits the most information 	None
Poor Quality 1D Reading	Enable this setting when scanning damaged or badly printed 1-D barcodes to improve barcode read success.	Disabled
Video mode	<p>Use this setting to specify whether normal or inverse decoding for linear symbologies is enabled during the execution of Decode. By default normal video is enabled.</p> <p>Options include:</p> <ul style="list-style-type: none"> • Normal • Inverse • Normal and Inverse 	Normal

Setting	Description	Default
DPM mode	<p>Use this setting when scanning Direct Part Marking (DPM) barcodes that are etched or imprinted directly into the surfaces of materials including metal and plastic.</p> <p>Options include:</p> <ul style="list-style-type: none"> • No DPM optimization • Dotpeen DPM decoding • Reflective DPM decoding 	No DPM optimization
Region of Interest	<p>Set the ROI for decoding. Options include:</p> <ul style="list-style-type: none"> • Disable ROI is disabled and the entire original image is sent to the decoder. • Standard Use the aimer position to weight activity. Activity calculated on the row and the column in the middle of each cell. The ROI window may not include the aimer. • Standard, aimer centered Activity calculated on the row and the column in the middle of each cell. The ROI window will always include the aimer. • DPM, aimer centered Activity calculated on 4 rows and 2 columns in each cell. The ROI window will always include the aimer. • Kiosk/presentation application Ignore aimer position, no weight activity. Activity calculated on the row and the column in the middle of each cell. The ROI window may not include the aimer. • Learning Engine When selected, the computer will receive continuous updates to improve the decoder software based on your specific environment. The Staging Hub Agent must also be enabled. 	Disabled

Setting	Description	Default
Multicode Scan	<p>When you enable Multicode Scan, each barcode is checked to see whether it satisfies the defined multicode rules before the results are transmitted. Options include:</p> <ul style="list-style-type: none"> • Enable or disable multicode scanning. • Set the number of barcodes. • Specify a separator to be used between barcodes. • Define up to 10 barcodes to be included in the multicode. • Set a timeout in milliseconds. If set with a non-zero value, the timeout starts after the scan button is pressed. Once the timeout occurs, scanning will return to standard (single) barcode mode. • Enable or disable the transmission of an incomplete multicode. When enabled, the incomplete multicode is transmitted when the incomplete transmission timeout expires. • Set a timeout in milliseconds to use when incomplete transmission is enabled. If set with a non-zero value, the timeout starts after the scan button is pressed. Once the timeout occurs, the results that were collected before the timeout happened will be transmitted if they satisfy the defined multicode rules. 	Disabled
Preferred Symbology Settings	<p>Set the priority level (High or Low) for symbology codes. This is used when you want to specify one symbology as a higher priority over other symbologies in situations where both bar code symbologies appear on the same label, but the lower priority symbology cannot be disabled. If a code is set as a High Priority, the decode of that symbology is accepted immediately. If a code is set as a Low Priority, the decode is buffered to see if a decode of a preferred High Priority symbology can be found within a given timeout period.</p> <p>To apply Preferred Symbology Settings, tap the check box. Preferred Timeout (ms) - The amount of time milliseconds that will allow the scanner to search for a High Priority bar code after a Low Priority bar code has been encountered. The default is 500ms.</p> <p>To set the priority level for a symbology, tap the code in the list then select the priority. The default for all codes is "High Priority".</p>	Disabled

Imager Settings

You should not need to modify the Imager Settings. The **Override Recommended Values** setting is disabled by default. The recommended Imager Settings are designed to work in a wide range of environments and should only be modified if you have an advanced understanding of imagers.

Trigger Settings

Use the Trigger Settings to configure how the scan buttons work.

Trigger Settings

Setting	Description	Default
Enable Scan Trigger	Enable or Disable activating the imager by pressing the side scan buttons or the virtual Scan button in the Scan Demo app.	Enabled
Scan delay	Set the minimum amount of time in seconds before the scanner can read another barcode.	0
Decode timeout	Set the number of seconds before the scanner automatically turns off if the scan button is pressed and nothing has successfully decoded.	20
Trigger Scan Mode	Set read behavior on scan button press. Options available: <ul style="list-style-type: none"> One Shot Continuous Read on release Read on second trigger press One Shot with preview - available only on models that use the rear camera as a scanner 	One Shot
Presentation Mode	Presentation Mode uses ambient light and scanner illumination to detect barcodes. When in Presentation Mode, the LEDs remain dim until a barcode is presented to the scanner, then the aimer turns on and the LEDs turn up to read the code. If the light level in the room is not high enough, Presentation Mode may not work properly.	Disabled
Same symbol timeout	Set the minimum buffer time in seconds before the scanner reads the same barcode. This can be adjusted to prevent inadvertent scans of the same barcode if the code is left in the scan field longer than the Decode Timeout limit. The default same symbol timeout is 1000 seconds.	Disabled

Notification Settings



Use the Notification Settings to configure how your computer responds when you scan a barcode.

Notification Settings

Setting	Description	Default
Good Read Notification	Enables or disables a good read notification. The notification consists of a green blink of the Scan Status LED, a short beep, and an optional short vibration.	Enabled
Bad Read Notification	Enables or disables notification of a failed scan. The notification consists of a red blink of the Scan Status LED, an error beep, and an optional short vibration.	Disabled
Vibrate On Notification	Enables or disables whether the computer vibrates when there is a good or bad read.	Disabled

Add a Scan Setting Profile

To create a scan setting profile for a custom app on the computer:

1. Swipe up from the bottom of the Home screen to access all apps.
2. Tap **Settings**  > **Honeywell Settings** > **Scanning** > **Internal Scanner**.
3. Tap  in the upper right corner of the app screen.
4. Take one of the following actions:
 - Tap the profile name field. Add a new name, and then select **OK**.

OR

- Tap the **select an application** option, and then choose an app from the list.

The new profile appears on the Internal Scanner profile list. You can now select and modify the scan settings for the new profile.

Delete a Scan Setting Profile

1. Swipe up from the bottom of the Home screen to access all apps.
2. Tap **Settings**  > **Honeywell Settings** > **Scanning** > **Internal Scanner**.
3. Tap and hold the profile you want to delete.
4. Tap **Delete**, and then **OK**.

Change the Bluetooth Scanner Settings

When a Bluetooth scanner is paired, changes can be made to the Default profile for the scanner.

1. Swipe up from the bottom of the Home screen to access all apps.
2. Tap **Settings**  > **Honeywell Settings** > **Scanning**.
3. Tap **Bluetooth Scanner** > **Default Profile** > **Data Processing Settings**.
4. Modify the settings to meet your application needs.

To learn more about the scanner settings, see [Data Processing Settings](#) on page 35.

About the Optional Digital Scan Button

By default, the imager is enabled for scanning with the left, right, and rear scan buttons configured to trigger the imager. If your application environment requires use of an on-screen scan button, enable the Digital Scan Button feature in the Settings app. Once enabled, you can then modify the appearance of the on-screen Scan button and select the apps the button appears in.

Enable and Configure the Digital Scan Button

1. Swipe up from the bottom of the Home screen to access all apps.
2. Tap **Settings**  > **Honeywell Settings** > **Digital Scan Button**.
3. Tap **Enable Digital Scan Button** to turn the feature on. A preview of the button appears at the bottom of the screen.
4. Configure the button appearance. As you adjust the settings, the preview button updates.
 - Tap **Select Button Size**, and then choose Small, Medium or Large.
 - Tap **Select Button Color** and then choose from seven color options. Default color is black. Tap a dot to select the color, and then select **OK** to confirm.
 - Use the slider under **Transparency Level** to adjust how transparent the button appears on the application screen.
5. Drag the preview button to the location where you want it to appear on the screen. Once you have positioned the button, select the **Set Button Location** toggle button to lock it into position.
6. Tap **Choose Application**.
7. Check the box next to all the applications where you want the digital scan button to be available.
8. Select **OK**.
9. Tap **Back** to return to the Settings screen.

The digital scan button appears on the screen when you open any of the apps you selected during the button setup. Tap and hold the button to activate the imager and scan a barcode.

Scan Barcodes

Depending on the model, the EDA10A is configured to use either the integrated imager or rear camera for scanning. Only one scanning solution will be enabled on the device, so units with the integrated imager cannot use the rear camera for scanning.

Before you start scanning barcodes, go into **Settings > Honeywell Settings > Scanning > Internal Scanner** and modify the scan profile to enable only the barcode symbologies that you need. By reducing the active symbology list, you can increase scan speed.

Note: To enable the rear scan touch key, navigate to **Settings > Honeywell Settings > Touch Key** and turn on **Touch Key Switch** or swipe down from the top of the screen and tap **Touch Key**.

Scan Barcodes with the Imager

Models with a built-in imager support omni-directional (360°) barcode scanning, and include an aiming beam to help with targeting barcodes.

1. Point the scanner window at the barcode. For optimum performance, avoid reflections by scanning the barcode at a slight angle.
2. Press and hold the right or left scan button or tap the rear touch key.
3. Center the aiming beam over the barcode. Make sure the entire barcode is inside the illumination frame.

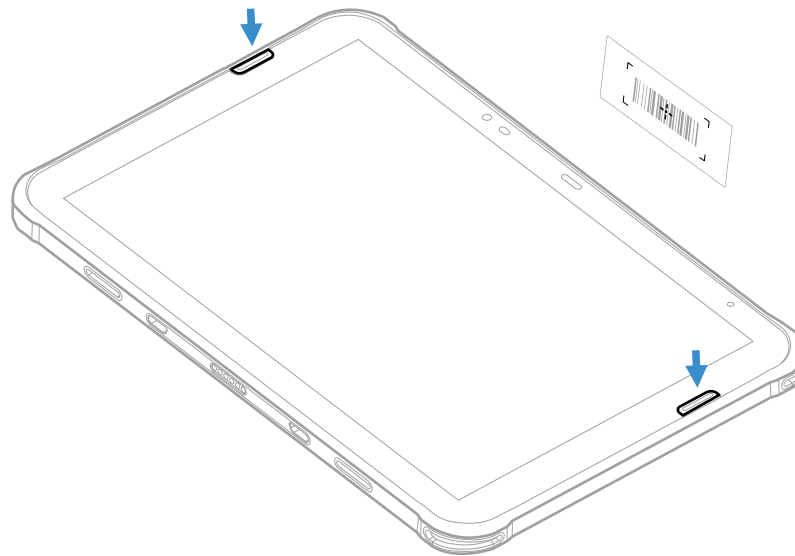

4. Release the button when the computer beeps. The barcode information is entered into the application in use.

Note: Not all barcode symbologies are enabled by default. If a barcode does not scan, the correct symbology may not be enabled.

Scan Barcodes with the Rear Camera

EDA10A models that do not have the built-in image engine can use the rear camera as a scanner.

The rear camera does not provide an aiming beam. A preview is displayed on the mobile computer to help assist with targeting barcodes. To enable the camera preview, the Trigger Scan Mode must be set to “One shot with preview.” See [Trigger Settings](#) on page 39 for more information.

Note: To scan barcodes with the rear camera, you must use a scanning app. The Android camera app cannot be used on its own to scan barcodes.

1. Point the rear camera at the barcode.
2. Press and hold any **Scan** button.
3. Use the aimer in the preview window to locate the barcode.

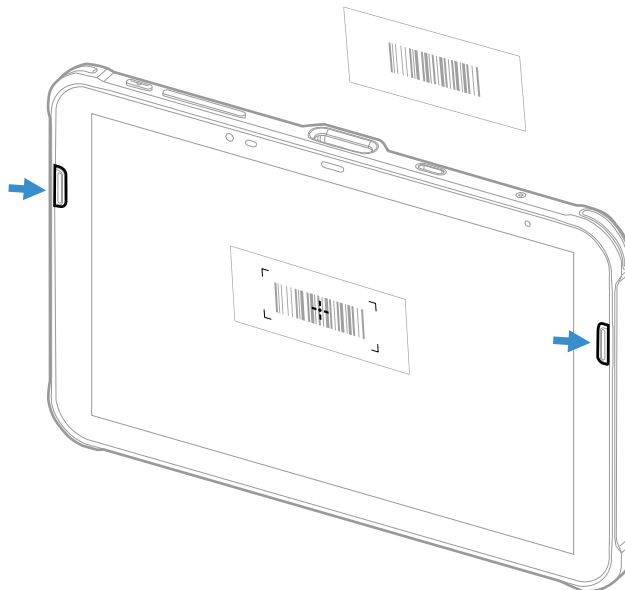

4. Release the **Scan** button when the computer beeps, and the Good Read LED briefly turns on. The barcode information is entered into the application in use.

About Scanning Configuration Barcodes

After completing the out-of-box set up process, Provisioning mode is automatically turned Off. Scanning a barcode to install applications, certificates, configuration files, and licenses on the computer is restricted unless you turn On (enable) Provisioning mode in the Settings app.

To learn more [About Provisioning Mode](#) see [page 78](#).

Use the Scan Demo App

Use the Scan Demo app to read barcodes or to test your symbology decode settings.

1. Swipe up from the bottom of the Home screen to access all apps.
2. Tap the **Demos** app.
3. Swipe left or right on the screen until **Scan Demo** appears under the turntable. Tap the center of the box image to open the app.
4. Point the scanner window at the barcode.
5. Press and hold the right or left scan button, tap the rear touch key, or tap and hold the on-screen **SCAN** button.
6. Center the aiming beam over the barcode. Make sure the entire barcode is inside the illumination frame.
7. Release the Scan button when the computer beeps. Barcode information appears on the screen.

Note: *In the Scan Demo app, not all barcode symbologies are enabled by default. If a barcode does not scan, the correct symbology may not be enabled.*

Change the Scan Demo Symbology Settings

1. In the Scan Demo app, tap  in the upper right corner of the screen.
2. Select **Symbology Settings**.
3. Modify the symbology parameters.
 - Tap the check box next to a symbology name to enable (check mark) or disable (no check mark) decoding for that symbology.
 - Tap the symbology name to view and modify additional configuration parameters for the symbology selected.
4. Tap **Back** to return to the Scan Demo app.

USE THE PHONE

You can use the phone feature to make and receive phone calls as well as transmit data through wireless wide-area networks (WWANs).

Note: *Phone features are only supported on EDA10A WWAN models (EDA10A-1).*

About the Phone

Phone features on the tablet include a speaker and a microphone. You can also use a Bluetooth headset or hands-free kit.

On EDA10A WWAN models, the phone feature is enabled by default and supports all cellular radio access technologies (2G, 3G, etc.) for voice and data connections around the globe.

After you turn on the phone and activate service with your wireless carrier, you can customize the phone features and network settings in the Wireless & Networks section of the Settings app.

Note: *WWAN radios support Network Information and Time Zone (NITZ) messages to automatically set the system time.*

Activate the Phone

WWAN models use either a nano-SIM card or embedded SIM (eSIM) to activate the phone and connect to a mobile network. Available SIM options are model and mobile carrier dependent. Contact your mobile service provider to obtain a nano-SIM card or QR code or for additional details on phone network activation.

Available configurations:

- EDA10A WWAN models include one nano-SIM card socket and eSIM.

Dual SIM Dual Standby Mode

The nano-SIM and eSIM can be provisioned with either the same or different mobile carriers. When both SIMs are provisioned, the EDA10a operates in Dual SIM Dual Standby (DSDS) mode. In this mode, both SIMs can connect to the selected mobile network. For example, you can have two phone lines on your mobile computer where one is your business number and one is your personal number. You can also choose which SIM to use for specific actions, such as calls or messaging. These actions are defined in **Settings > Network & internet > Mobile network**.

Provision eSIM

To connect to a mobile network using embedded SIM, the eSIM must be provisioned by downloading and enabling an operational profile. ScanPal devices use the eSIM Toolkit app to download carrier profiles into the eSIM chip and manage the downloaded profiles.

Devices are enrolled by scanning a QR code. You can also manually enter a code provided by the carrier. Contact your mobile carrier to obtain the QR code and any other information required to activate the profile.

Note: *Multiple profiles can be downloaded to the eSIM, but only one profile can be active.*

1. Swipe up from the bottom of the Home screen to access all apps.
2. Tap the **eSIM Toolkit** app.
3. Download the profile by scanning or entering a QR code:
 - a. If you have a QR code from the carrier, tap **Scan Download**. Scan the QR code by keeping the code centered in the box.
 - b. If you have an image of the QR code on the tablet, tap **Choose from album** then select the file.
 - c. If you do not have the QR code to scan but have an activation code from your provider, tap the **Input Download** text box. Enter the code in the text box then tap **OK**.
4. A prompt indicates that the download was successful.
5. Tap the **LUI** button.
The profile is shown under Enabled carriers.

The Access Point Name (APN) for most global mobile operators is integrated in the eSIM firmware. If the APN for your carrier is not integrated, you will need to manually enter the APN settings in **Settings > Network & internet > Mobile plan**.

Provision nano-SIM Card

Note: On EDA10A WWAN models with an eSIM, you do not need to install a nano-SIM card unless you want a dual carrier setup.

1. Press and hold the **Power** button until the options menu appears.
2. Tap **Power Off**.
3. Remove the battery from the computer. Refer to [page 6](#).
4. Slide the card holder tray out of the slot.

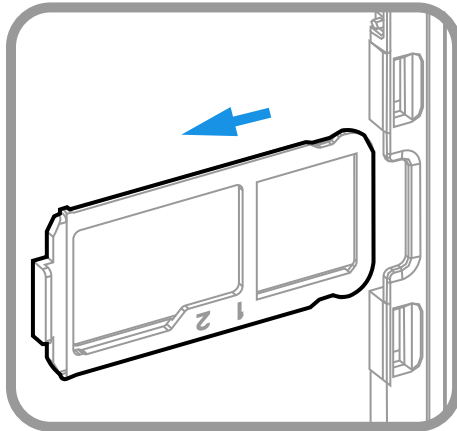



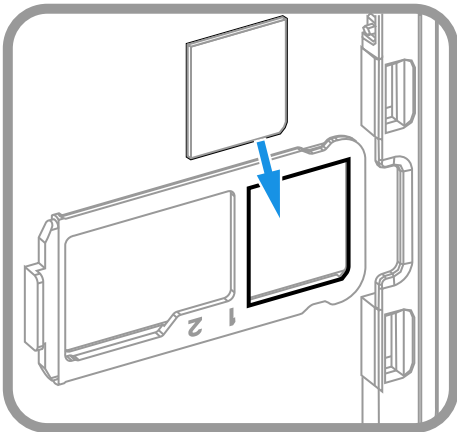



5. Place the nano-SIM card into the card holder tray with contacts facing down.



6. Slide the card holder tray back into the card holder slot.
7. Install the battery. Refer to [page 6](#).
8. Press the **Power** button to restart the mobile computer.
9. Follow the mobile provider's instructions to complete the setup and activate the phone.

Make a Phone Call

Once the phone is activated, you can make a phone call.

1. Tap  in the favorites tray to open the phone app.
2. Use one of the methods below to enter the telephone number you want to call.
 - Tap  and use the on-screen dialer.
 - Select a person on your saved contact list .
 - Select a favorite on your speed dial list .
 - Select a number from the recent calls list .
3. Tap call .
4. To end the call, tap .

Answer the Phone

When you receive a phone call, the Incoming Call screen opens. If the caller telephone number is available, it appears on the screen. Depending on your calling plan, you may also see a Caller ID information. All incoming calls are recorded in the Call log. If you miss a call, you receive a notification.

On the Incoming Call screen, when you phone is lock screen activated:

- Swipe up on the screen to answer the call.
- Swipe down on the screen to reject the call and send it to voicemail.
- Tap the messaging icon  to send a text message response to the call instead of answering.

If your phone is already unlocked, a notification appears on the screen for the incoming call and you have the choice to select **Answer** or **Ignore**.

Switch Apps During a Phone Call

You can multi-task while a phone call is in progress. For example, you can use the Calendar app to check your schedule during a call.

Note: *Depending on your WWAN connection and carrier, apps that need a data connection may be unable to access online data while the phone call is in progress. If simultaneous phone calls and data connections are not possible due to provider limitations, voice calls receive priority. Check with your provider for more information.*



1. During a phone call the screen goes dark. Take the phone away from your ear to wake the screen. Tap the **Home** button.
2. Select another app (e.g., Calendar, Contacts). The phone icon appears in the status bar at the top of the screen while the call is connected.
3. To return to the call screen, swipe down from the top of the screen and select ongoing call notification or select **Hang up** if you want to end the call.

Make an Emergency Phone Call

You can use the phone to make an emergency phone call even if the SIM card is missing from your phone. The phone shows no service but the call still goes through if you dial certain emergency numbers (e.g., 112, 911, 000, 08, 118, 119, and 999).

Configure Phone Settings

You can customize settings for the phone, including the ringtone, voicemail options, keypad tones, Internet call settings, and other options.

1. Open the phone app .
2. Tap  next to the microphone icon at the top of the screen.
3. Select **Settings**. The Call settings menu appears.
4. Change phone settings as necessary.

Note: *Available settings vary depending on your cellular carrier and phone plan.*

Use this chapter to learn how to take pictures and record videos with the color camera.

Note: EDA10A tablet models that do not include an integrated scan engine can use the rear camera as a barcode scanner. See [Scan Barcodes with the Rear Camera](#) on page 44 for information.

About the Color Camera

The EDA10A comes equipped with two color cameras: an 8-megapixel camera located on the front, and a 16-megapixel camera on the rear. The EDA10A offers 4K video support with image stabilization and advanced software features for enhanced exposure control when taking pictures and videos.

Use the Photos app  to view photos and videos stored on the EDA10A. By default the photos and videos captured with the Camera app are saved on the computer under Internal shared storage\DCIM\Camera.

How to Zoom

The camera zoom is controlled using a pinching motion on the touch screen. Place two fingers on the screen at the same time, and then:

- spread them apart to zoom in (enlarge and object).
- pinch them together to zoom out.





Take a Photo



1. Tap the **Camera** icon  in the favorites tray on the Home screen.
2. Using the screen as a viewfinder, move the computer until you see the image you want to capture.

3. The camera automatically adjusts the focus but you can tap the screen to modify the focal point. By default, the rear camera senses the lighting in the environment and turns the flash on, if needed.
4. Tap  or the Volume button to take a photo.
 - To view the picture, tap the preview near the bottom of the screen.
 - To return to the Camera app, tap the **Back** navigation button.

Record a Video

This section explains how to record video with the camera in the computer.

1. Tap the **Camera** icon  in the favorites tray.
2. Tap  to start recording video.
 - To zoom in or out, pinch or spread your fingers apart.
 - To toggle sound recording on or off, tap the microphone icon at the top of the screen.
 - To pause recording, tap . To resume recording, tap .
 - To capture a still picture during recording, tap the camera icon.
 - To add light while recording, tap the flash icon. Flash is only available with the camera located on the rear of the computer.
3. When you are done recording, tap .

To access the video settings in the Camera app, select the **More Settings** icon , then **Advanced Settings** .

Change Camera Settings

You can change the camera settings for best results when taking pictures. The camera settings are adjustable from within the Camera app.

1. Open the **Camera** app .
2. From the toolbar, select any of the following to adjust the settings.

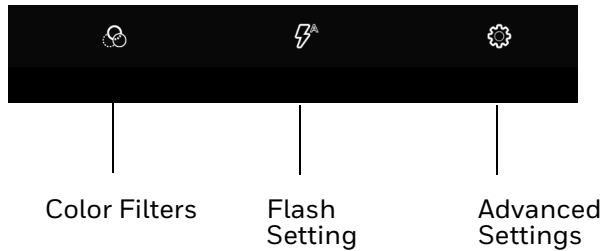

- **Color Filters**
Stylize your pictures by applying a filter. Options include: None, Sepia, Negative, Solarize, Posterize, and Aqua.
- **Flash Setting**
Select to adjust the camera flash setting (e.g., automatic, no flash or always flash). This option is only available for the rear camera.
- **Advanced Settings**
Select  to manually set advanced features. Options include: Flash, GPS location, Picture size, Picture quality, Countdown timer, Storage, Continuous shot, Face detection, ISO, Exposure, White balance, Redeye reduction, and Shutter sound.
- **HDR**
Tap to quickly toggle HDR mode On or Off. When enabled, the computer automatically captures multiple photos and combines them into one photo, creating the best quality image possible.
- **ProMode**
Select ProMode to manually control settings for ISO exposure, white balance, and focus.
- **Camera Selection**
Switch between the front and rear camera.

Use the Camera as a Flashlight

To use the rear camera as a flashlight.

1. Open Quick Settings (see page [27](#)).
2. Tap the **Flashlight** icon to turn the flashlight on.
 - Select the icon again to turn the flashlight off.

CONFIGURE THE COMPUTER

Use this chapter to learn about the available methods for configuring your mobile computer. You can also use this chapter to learn how to configure network communications and wireless security.



How to Configure the Computer

You can configure many parameters on the computer such as the bar code symbologies the integrated scanner decodes, or the network settings. The values you set for these parameters determine how the computer operates.

You configure the computer using the Settings app.

Start the Settings App

The Settings app is available from the all apps menu and the notification panel.

- Swipe up from the bottom of the Home screen to access all apps, and then tap **Settings** .
- OR
- Swipe down from the top of the Home screen, and then select  in the status bar.

About the Structure of the Settings App

Use this section to learn about the structure of the Settings app so you can find parameters quickly. A search field appears at the top of the screen when you open the Settings app to help you locate settings quickly.

Note: *The Settings app varies by computer model and OS version. Your computer may not include all the features outlined in this section.*

Network & internet

In the Settings app, select **Network & internet** to access the following settings.

Setting	Description
Wi-Fi	<ul style="list-style-type: none">• Turn WLAN radio On or Off.• Lists available Wi-Fi networks in range and the connection status when the radio is turned On.• Add a network Wi-Fi connection.• Set Wi-Fi preferences and advanced settings.
Mobile network	Modify mobile network settings, including enabling data access and roaming over mobile networks, selecting access points and network operators, or selecting only 2G networks (to save battery life).
Airplane mode	Turn Airplane mode On or Off.
Ethernet	<ul style="list-style-type: none">• Turn Ethernet connection On and Off.• Configure Ethernet connections and set up proxy settings when the Ethernet setting is turned On.
Hotspot & tethering	Provide internet to other devices through your mobile data connection. Select Wi-Fi hotspot, USB tethering, Bluetooth tethering, or Ethernet tethering.
Data Saver	<ul style="list-style-type: none">• Turn the Data saver feature On or Off.• Specify which apps can use unrestricted data.
VPN	Set the password parameters for a virtual private network (VPN) connection.
Mobile plan	Provides information on your cell phone plan.
Private DNS	Select Private DNS Mode.

Connected devices

In the Settings app, select **Connected devices** to access the following settings.

Setting	Description
USB	Select the type of communication: <ul style="list-style-type: none">• File Transfer• USB tethering• MIDI• PTP• No data transfer <p>Note: This setting only appears when the unit is connected via USB.</p>
Pair new device	<ul style="list-style-type: none">• Connect a Bluetooth Device.• Lists Bluetooth-enabled devices in range.• View and rename the computer.• View the computer Bluetooth address.
Previously connected devices	View previously connected devices.

Setting	Description
Connection preferences	
Bluetooth	<ul style="list-style-type: none"> Use Bluetooth - Turn the Bluetooth radio On or Off. Lists Bluetooth enabled devices in range when the radio is turned On. Connect to a Bluetooth Device. View and rename the computer. View the computer Bluetooth address. View received files.
NFC	Use NFC - Turn Near Field Communication (NFC) On or Off. When the NFC radio is enabled, data exchanges are allowed when the computer touches another NFC enabled device.
Cast	Set up a Cast connection. Cast (project) audio and screen content to a secondary device such as a television.
Printing	Set up a printer connection with the EDA10A. Connection options include cloud print services, Wi-Fi printing via a router or printing via NFC.
Chromebook	Connect the EDA10A to a Chromebook.
Nearby Share	Share files with nearby devices.
Android auto	Use apps on a compatible vehicle screen.

Apps

In the Settings app, select **Apps** to access the following settings.

Setting	Description
All apps	View a list of all apps installed on the computer and system services running.
Default apps	View and manage default app use.
Screen time	<ul style="list-style-type: none"> Show screen time, notifications received, times opened. Set app timer.
Unused apps	View and manage apps that are unused for over three months.
Special app access	Manage apps with special unrestricted access.

Notifications

In the Settings app, select **Notifications** to access the following settings.

Setting	Description
App settings	Control notifications from individual apps.
Notification history	Shows recent and snoozed notifications.
Conversations	Priority and modified conversations will appear here.
Bubbles	Turn on Bubbles to enable conversations to appear as floating icons on top of other apps.
Device & app notifications	Controls which apps and devices can read notifications.
Notifications on lock screen	Controls display of notifications on lock screen.

Setting	Description
Do Not Disturb	Set people, apps, and alarms that notifications will be displayed from.
Wireless emergency alerts	Manage emergency alert notifications.
Hide silent notifications in status bar	Icons from apps with silent notifications will not be displayed in the status bar.
Allow notification snoozing	Silences notifications for up to two hours.
Notification dot on app icon	Displays a dot on the icon for an app with an active notification.
Blink light	Enables a blinking light to display when a notification is received.
Enhanced notifications	Shows suggested actions and replies and organizes notifications.

Battery

In the Settings app, select **Battery** to view battery status, use statistics and adjust features that conserve battery charge.

Setting	Description
Battery	View current battery charge or charging status.
Battery usage	Displays battery usage from last full charge.
Battery Saver	Turn the Battery saver feature On or Off and set when the feature automatically activates. <ul style="list-style-type: none"> • Never • When the battery charge is at 5% • When the battery charge is at 15%
Battery Manager	Turn the Battery Manager On or Off.
Battery percentage	Set to show or do not show battery percentage in status bar.

Storage

In the Settings app, select Storage to view statistics on available and used storage space on the device and on any portable storage cards installed.

Sound

In the Settings app, select **Sound** to modify the audio and sound settings. To learn more, see [Audio Settings](#) on page 18.

Display

In the Settings app, select **Display** to access the following settings.

Setting	Description
Brightness level	Set the Brightness level manually if Adaptive brightness feature is turned Off.

Setting	Description
Adaptive brightness	Set how the screen in sleep mode responds when new notifications are received (e.g., wake or do not wake).
Lock screen	Select what to show on the lock screen and when to display new notifications.
Screen timeout	Set the inactivity time limit before the unit automatically turns of the screen to save battery power (seconds or minutes).
Dark theme	Enable dark theme to switch app backgrounds to black.
Font size	Set the default on-screen text size.
Display sizes	Set the default size of items on your screen.
Night Light	Activate the Night light feature to adjust the screen tint to a light amber for easier viewing and reading in dim light or for the hours you use the device before going to sleep. Set the feature to stay on or define a schedule to automatically turn the feature On/Off. You can manually adjust the intensity of the amber hue once the feature is activated.
Colors	Select to display Natural or Boosted colors.
Auto-rotate screen	Set the screen to switch from portrait to landscape when the unit is rotated. When Off the screen does not automatically rotate.
Screen saver	Set the default screen saver as well as when to display it. Tap Settings to select screen saver style or to turn Night mode on.

Wallpaper

Select the wallpaper from Live Wallpapers, Photos, or Wallpapers on the unit.

Accessibility

In the Settings app, select **Accessibility** to access screen readers, display settings, interaction controls, and audio & on-screen text features to improve accessibility levels.

Setting	Description
Screen reader	
Select to Speak	When turned on, you can tap specific items on the screen to hear them read aloud.
TalkBack	When turn on, the feature provides spoken feedback so you can use the computer without always looking at the screen. TalkBack describes your actions and tells you about alerts and notifications.
Display	

Setting	Description
Text and display	Configure display features that may aid visual accessibility levels. <ul style="list-style-type: none"> Adjust Font size Adjust Display size Turn Bold text On or Off Set Color correction Turn Color inversion On or Off Turn Remove animations On or Off Turn Large mouse pointer On or Off Turn High contrast text On or Off
Extra dim	Turn On to dim the screen beyond the minimum brightness level.
Dark Theme	Turn dark them On or Off and set a schedule.
Magnification	Manage options to quickly zoom the screen to make content larger.
Interaction controls	
Accessibility Menu	Turn the Accessibility Menu button on or off. The Accessibility Menu is a large on-screen menu you can use to control your device. Use the Accessibility shortcuts setting to select Accessibility menu options.
Switch Access	Use a switch or keyboard to control your device.
Timing controls	Manage timing options for actions. <ul style="list-style-type: none"> Adjust the Touch & hold delay. Time to take action (Accessibility timeout). Set the Autoclick delay (dwell timing) to automatically click after the pointer stops moving.
System controls	Set interaction controls that may aid physical accessibility levels. <ul style="list-style-type: none"> Set System navigation (Gesture navigation or 3-button navigation). Turn the Power button ends call feature On or Off. Turn Auto-rotate screen On or Off.
Vibration & haptic strength	Manage options for vibration features. <ul style="list-style-type: none"> Turn Ring vibration On or Off. Turn Notification vibration On or Off. Turn Touch vibration On or Off.
Captions	
Caption preferences	Turn the Show captions feature On or Off and manage options for captions.
Audio	
Audio adjustment	Manage audio options. <ul style="list-style-type: none"> Turn Mono audio On or Off. Set Audio balance if using headphones or hearing aids.
General	
Accessibility shortcuts	Manage the accessibility button, which provides a shortcut for accessibility options from any screen.
Text-to-speech output	Select and configure the preferred TTS, language, speech rate, and pitch of synthesized voice.

Security

In the Settings app, select **Security** to view latest Security scan results, security updates and phone encryption status. Access additional settings related to device security.

Setting	Description
Google Play Protect	Manually initiate a scan of the apps on the device to check for problems.
Find My Device	Allows users to locate, ring, or wipe a device remotely.
Security update	Displays the last date security was updated on the device.
Screen lock	Activate and configure a screen lock (i.e., None, Swipe, Pattern, Pin, Password).
Smart Lock	Define safe conditions or locations where the tablet will stay unlocked (e.g., on-body, trusted places, trusted devices).
Device admin apps	Manage administrator privileges.
Encryption & credentials	View encryption status and manage trusted credentials (e.g., view, install, clear, and edit).
Trust agents	View and enable/disable trusted agent apps such as, Smart Lock by Google on the device. Trusted agents bypass security based on set parameters.
App pinning	Enable or disable the screen pinning feature. When enabled you can pin the device screen to a recently used app where it stays until you unpin the app via the security method chosen.
Confirm SIM deletion	Require a password to delete an eSIM.

Privacy

In the Settings app, select **Privacy** to define privacy settings for the device.

Setting	Description
Privacy dashboard	Shows which apps recently used permissions.
Permission manager	View and manage individual app permissions.
Camera access	Enable or disable app access to the camera.
Microphone access	Allows microphone access for apps and services.
Show passwords	Enable or disable showing characters briefly as you type.
Notifications on lock screen	Enable or disable notifications on the lock screen.
Show clipboard access	Displays a message when apps access text, images, or other content you've copied.
Autofill service from Google	Automatically fill fields using saved data from your Google account.
Google location history	Enable or disable location history and manage or delete activity. A Google account must be associated with the device to use this feature.

Setting	Description
Activity controls	Choose what type of activities are saved in your Google account. A Google account must be associated with the device to use this feature.
Ads	Opt in or out of ad personalization features. When this feature is on, ads are personalized with the activity and information from your Google account.
Usage & diagnostics	Automatically send diagnostic, device, and app usage data to Google. A Google account must be associated with the device to use this feature.

Location

In the Settings app, select **Location** to define which apps have access to the device's location.

Setting	Description
Use location	Turn location services (Google and GPS satellite data) On or Off. Set location mode accuracy and view location request history.
App location permissions	View and manage app-level location service permissions.
Location Services	
Emergency Location Service	Allows the device to automatically send its location to emergency locations.
Google Location Accuracy	Improves location accuracy by using Wi-Fi, mobile networks, and sensors to help estimate the device's location.
Google Location History	Allows the device to report location history to Google. A Google account must be associated with the device to use this feature.
Google Location Sharing	Allows the device to share its location with anyone in the contacts list.
Wi-Fi scanning	Turn Wi-Fi scanning On or Off. When enabled system apps and services are allowed to detect Wi-Fi networks at any time to improve location services.
Bluetooth scanning	Turn Bluetooth scanning On or Off. When enabled system apps and services are allowed to detect Bluetooth devices at any time to improve location services.

Safety & emergency

In the Settings app, select **Safety & emergency** to define emergency contact information.

Setting	Description
Emergency information	View or update medical information and emergency contacts.
Emergency SOS	Define Emergency SOS settings.
Emergency Location Service	Turn Emergency Location Service on or off.
Wireless emergency alerts	Manage emergency alert notifications.

Honeywell Settings

In the Settings app, select **Honeywell Settings** to access the following settings.

Setting	Description
Battery LED	Configures the battery LED behavior. To learn more see, Change the Battery Status LED Behavior on page 12.
Battery Optimizer	View battery status and app usage information. Create and enable or disable a battery optimization profile that implements a group of settings to conserve power. Options include: <ul style="list-style-type: none"> • None When selected, no battery optimization profile is active. • Energy Saver This pre-defined profile implements UI settings that optimize battery conservation. • Cold Storage This pre-defined profile implements UI settings that optimize battery conservation in cold storage environments. • Custom Profile Tap to create a custom battery profile that balances your application needs with energy saving settings. You can turn location services On or Off, configure sound and vibration options, modify brightness and timeout display options, turn UI transition animations On or Off and background services On or Off.
Digital Scan Button	Enable and configure the optional digital scan button. To learn more, see About the Optional Digital Scan Button on page 42.
Display Dock Service	Display and peripheral options when using the EDA10A Enterprise Tablet in a desktop dock. (See the <i>EDA10A Accessories User Guide</i> for more information about docks.) <ul style="list-style-type: none"> • Monitor Setting – Set the tablet’s display orientation, resolution and density when docked. • Peripheral – Choose settings for mouse button behavior. • Mode – Set display options for external monitors.
Glove Mode	Turn Glove Mode on for the best touch screen response when users wear gloves.
Honeywell Power Setting	Turn Unattended Mode On or Off. When Unattended Mode is on, healthcare apps will continue to notify clinicians of critical communication, even though the unit appears to be in sleep mode.
HXLogger	The HXLogger is an advanced diagnostic log service that provides a basic log service, plug-ins for modified log services, and a log manager. <ul style="list-style-type: none"> • Tap HXLogger to turn the basic log service On or Off. When enabled the service records app and system diagnostic troubleshooting information into four basic log files: main log file, radio log, event log, and kernel log. • Tap Plugin to view and enable additional log services and custom plug-ins. • Tap Manager, to change the default log path, delete logs or upload logs for technical support troubleshooting.

Setting	Description
Key WakeUp	Set the buttons you want to use to wake the computer from sleep mode. Options include: Left Scan, Right Scan, Volume Up and Volume Down.
Keyremap	Change (remap) a button or key function. To learn more, see Remap a Button or Key on page 25.
Provisioning Mode	Enable or disable unrestricted installation of applications, certificates, configuration files, and licenses. Provisioning mode is turned Off by default. To learn more About Provisioning Mode , see page 78.
Scanning	Configure the computer imager. To learn more, see Change the Scanner Settings on page 34.
Smart Sensor	Configures the integrated motion detection sensors for advanced power management. Options include: Keep awake on motion and Face down suspend.
Staging Hub Agent	Use this agent and settings to connect the computer to the Honeywell Staging Hub Foundation software platform; a centralized software platform IT integrators and administrators can use as a solution for managing, monitoring and deploying Honeywell devices in a connected workspace environment.
Touch Key	Turn the Touch Key Switch on or off. When the Touch Key Switch is on, the rear scanner button is active.
Web Applications	Enable access for Honeywell Mobility SDK for Web apps and port selection.

Passwords & accounts

In the Settings app, select **Passwords & accounts** to access the following settings.

Note: Some settings in previous OS versions can be found in System.

Setting	Description
Passwords	View, change, or remove passwords saved in your Google account.
Autofill service	Turn Autofill with Google on or off.
Add account	Select to add and manage Corporate or Email account on the computer.
Automatically sync app data	Turn auto-sync On or Off for accounts. Turning the feature On allows apps to refresh data automatically.

Digital Wellbeing & parental controls

In the Settings app, select Digital Wellbeing. See <https://wellbeing.google> for more information.

Google

In the Settings app, select **Google** to set up and manage your Google accounts and services.

System

In the Settings app, select **System** to access the following settings.

Setting	Description
Languages & input	<ul style="list-style-type: none">• Set the active language.• Set and manage Virtual and Physical Keyboard input methods.• Configure auto-typing features such as capitalization, punctuation, spell check, and the personal dictionary.• Adjusts the pointer speed.• Set text-to-speech output.
Gestures	Define gesture settings: <ul style="list-style-type: none">• Quickly open camera.• Set System navigation preferences.• Press and hold power button• Set the Prevent ringing option. Options: Vibrate, Mute, Do Nothing.
Date & time	Configure all date and time settings.
Backup	Turn the Google Drive backup feature On or Off. When enabled, phone data (e.g., apps, apps data, call history, contacts, device settings, SMS, Wi-Fi passwords and permissions) is automatically backed up to the Google Drive.
System update	Check for available Android system updates.
Multiple users	<ul style="list-style-type: none">• Modify the owner profile name and add profiles for other people who use the computer.• Activate a different user profile.
Developer options	Enable developer-specific options such as USB debugging and SD card protection. This option only appears under System settings if you enable the feature. To learn more, see Unlock Developer Options on page 32.
Reset options	Select from the following reset options: <ul style="list-style-type: none">• Reset Wi-Fi, Mobile & Bluetooth Use to reset all network settings, including Wi-Fi, Mobile data and Bluetooth.• Reset app preferences. Use reset app preference back to defaults. This apps you disabled, notification changes, default app actions set, background data restrictions for apps and permission restrictions.• Enterprise data reset. To learn more, see Enterprise Data Reset the Computer on page 82.• Erase all data (factory reset). To learn more, see Erase All Data (Factory Reset) on page 83.

About tablet

In the Settings app, select **About tablet** to access the following information.

Setting	Description
Device name	A nickname to identify the device. To change, tap Device name and enter a new name.
MDN	The phone number(s) assigned to the device (sim slot 1 and sim slot 2).
Legal information	Provides links to third-party licenses and other legal information.
Compliance information	Displays certification and compliance information.
SIM status	Displays information on the SIM card(s) in the device that can be used for diagnostic purposes.
Model	Displays the model number and serial number of the device.
IMEI	Displays the International Mobile Equipment Identify number(s).
Android version	The version of Android on the device. Tap to view additional details.
Asset number	Asset tag assigned to the device.
IP address	IP address associated with the device.
Wi-Fi MAC address	Wi-Fi Mac address associated with the device.
Bluetooth address	Bluetooth address associated with the device.
Up time	Time the device has been running since the last restart or power up.
Build number	Kernel number installed.

About Network Communications

You can easily add the mobile computer to your wireless or wired data collection network. Connect the EDA10A to your computer using:

- 802.11 a/b/g/n/ac/r/k/mc/ax radio communications
- Ethernet communications
- Bluetooth communications
- USB and serial communications

Connect to a Wi-Fi Network

The computer contains an 802.11 a/b/g/n/ac/r/k/mc/ax radio to transfer data using wireless communications. Before you connect to a Wi-Fi network, you need to know about your network security protocol and its required credentials.

By default, the 802.11 radio is disabled.



1. Swipe up from the bottom of the Home screen to access all apps.
2. Tap **Settings**  > **Network & internet** > **Wi-Fi**.

3. Tap **Use Wi-Fi** to toggle Wi-Fi radio on. A list of discovered networks appears.
4. On the list, tap a network name to initiate a connection.

To add a network if it does not appear on the list:

- a. Navigate to the end of the discovered network list, and then tap **Add network**.
 - b. Type the Wi-Fi network name (SSID).
 - c. Choose a security protocol and add any required information.
 - d. Tap **Save**.
5. Enter any required information if the network is secured (e.g., password, key or certificate name).
 6. Tap **Connect**.



Once you connect to a saved Wi-Fi network:

- Tap  next to the network name on the list to view details (e.g., status, signal strength, speed, frequency, security type). Select  to close the details screen.
- The computer automatically connects to the same network when the network is in range and the WLAN radio is turned On.
- To remove a network from your saved list, tap and hold the network name and select **Forget**. You can do this for networks you no longer use.
- To view a list of only your saved networks, navigate to the bottom of the discovered network list. Tap **Saved networks**.

Configure Proxy Settings for a Wi-Fi Network

If you need to connect to network resources through a proxy server, you can configure settings for the proxy server for each Wi-Fi network you add. By default, the Wi-Fi networks you add are not configured to connect through a proxy server.

Note: Proxy settings apply only to the Wi-Fi network you modify. You must change proxy settings for each network requiring a proxy server.

1. Swipe up from the bottom of the Home screen to access all apps.
2. Tap **Settings**  > **Network & internet** > **Wi-Fi**. The list of available Wi-Fi networks appears.
3. Tap the Settings icon .
4. Tap the Edit icon .
5. Tap **Advanced options**.
6. Under **Proxy**, select **Manual**.
7. Enter the proxy settings for the network.

8. Tap **Save**.

Disable Wi-Fi Notifications

By default, when Wi-Fi is enabled, you receive notifications in the Status bar when the computer discovers a wireless network. You can disable these notifications.

1. Swipe up from the bottom of the Home screen to access all apps.
2. Tap Settings  > **Network & internet** > **Wi-Fi**. Verify the WLAN radio is turned On.
3. Navigate to the bottom of the discovered network list.
4. Select **Wi-Fi preferences**.
5. Tap **Notify for public networks** to toggle the setting On or Off.

Connect to an Ethernet Network

To connect the computer to an Ethernet network, you need an EDA10A Display Dock.

1. Make sure the display dock is connected to your Ethernet network.
2. Place the computer in the base.
3. Swipe up from the bottom of the Home screen to access all apps.
4. Tap **Settings**  > **Network & internet** > **Ethernet**. The Ethernet setting is turned On by default.
5. Tap **Ethernet**.

The Ethernet connection screen shows the current Ethernet connection. By default, the computer assumes a DHCP connection, and that your network has assigned an IP address automatically. If DHCP is working, the Ethernet base should indicate that communication with the network is occurring.

6. (Optional) To assign a static IP address.
 - a. Tap **DHCP** and then select **Static** from the list.
 - b. Enter the required network information, and then tap **Apply**.
7. Tap **Save**.

How to Connect to Virtual Private Networks

The computer supports connecting to virtual private networks (VPNs). This section describes how to add and connect to VPNs. To configure VPN access, you must obtain details from your network administrator. You can view and change VPN settings in the Settings app.

Note: Before you can add or connect to a VPN network, you must enable a screen lock method.



Add a VPN

Before you can connect to a VPN, you must create a VPN profile.

1. Swipe up from the bottom of the Home screen to access all apps.
2. Tap **Settings**  > **Network & internet** > **VPN**.
3. Tap **+** to add a VPN new profile.
4. Enter the required information for the VPN connection. If needed, swipe up on the screen to access all the required information fields.
5. Tap **Save**. The VPN name appears in the VPN list.

Connect to a VPN



Once a VPN profile is created, you can connect to the VPN at any time.

1. Swipe up from the bottom of the Home screen to access all apps.
2. Tap **Settings**  > **Network & internet** > **VPN**.
3. Type the name of the VPN in the list.
4. Enter any necessary credentials when prompted.
5. Tap **Connect**. A  appears in the status bar and a notification is received.

To disconnect from the VPN, tap the notification.

Edit VPN Information

Editing an existing VPN profile can be done from the VPN screen.

1. Swipe up from the bottom of the Home screen to access all apps.
2. Tap **Settings**  > **Network & internet** > **VPN**.
3. Tap and hold the name of the VPN in the list.
4. Tap  to the right of the VPN profile you want to edit.
5. Edit the VPN settings as necessary.

6. When you are done, tap **Save**.

About Wireless Security

The computer provides these security solutions for your wireless network:

- Wi-Fi Protected Access 3 (WPA3™)
- Wi-Fi Protected Access 2 (WPA2™)
- Wi-Fi Protected Access (WPA)
- 802.1x

Honeywell recommends WPA3 security with SAE (Personal) or 802.1x (Enterprise) key management.

Before you set security, you need to enable the radio, set the date, and set the SSID on your computer. To use 802.1x security, you need to load a root certificate on your computer. To use transport layer security (TLS) with 802.1x security, you also need to load a user certificate.

Use the Settings app to access and configure all wireless security settings.

About Certificates

You can use digital certificates to identify the computer for network access or authentication to servers. To use a certificate to identify your device, you must install it in the trusted credential storage on the computer.

Android supports DER-encoded X.509 certificates saved in files with a .crt or .cer file extension. To install a valid certificate with a .der or other extension, you must change the extension to .crt or .cer to install it.



Android also supports X.509 certificates saved in PKCS#12 key store files with a .p12 or .pfx extension. To install a valid key store file with another extension, you must change the extension to .p12 or .pfx to install it. When you install a certificate from a PKCS#12 key store, Android also installs any accompanying private key or certificate authority (CA) certificates.

Load a Certificate

To use a certificate, you must install it in the trusted credential storage on the computer.

Note: *Apps such as email and browsers that support certificates allow you to install certificates directly from within the app. For more information, see the help that comes with the app.*

1. Copy the certificate or key store from your PC to the mobile computer.
2. Swipe up from the bottom of the Home screen to access all apps.

3. Tap **Settings**  > **Security** > **Encryption & credentials**.
4. Tap **Install a certificate**.
5. Select either CA certificate, VPN & app user certificate, or Wi-Fi certificate.
6. Tap the Menu icon , then navigate to the location where you saved the certificate or key store.
7. Tap the name of the certificate or key store to install it. If prompted, enter the key store password. Tap **OK**.
8. Type the name of the certificate.
9. Select **VPN and apps** or **Wi-Fi**.
10. Enter a name for the certificate and tap **OK**.

Disable or Remove Certificates

If a user or system certificate is compromised, or your organization chooses not to trust it, you can disable or remove the certificate.

1. Swipe up from the bottom of the Home screen to access all apps.
2. Tap **Settings**  > **Security** > **Encryption & credentials**.
3. Select **Trusted credentials**.
The trusted credentials screen has two tabs:
 - **System** shows Certificate Authorities (CA) certificates permanently installed on the computer. They can only be disabled.
 - **User** shows CA certificates you have installed yourself. You can remove these certificates.
4. Tap the name of the certificate to you want to disable or remove. The Security certificate screen appears.
5. Scroll to the bottom of the screen and tap **Disable** (for System certificates) or **Remove** (for User certificates).
6. Tap **OK**.

Note: You can enable a disabled System certificate but if you remove a User certificate, you must install it again to enable it.

About Bluetooth Communications

Your mobile computer is equipped to communicate with other devices using Bluetooth technology. The Bluetooth radio must be turned On to discover, pair and connect to other Bluetooth devices. System bar icons indicate Bluetooth radio status.

Connect a Bluetooth Device

To connect to a Bluetooth device, you must turn On the Bluetooth radio and then select the device from a list of discovered devices.

1. Swipe up from the bottom of the Home screen to access all apps.
2. Tap **Settings**  > **Connected devices**.
3. Tap **+ Pair new device**. A list of Bluetooth devices appears.
4. Select a device on the list to initiate a pairing request.
5. When the pairing request message appears:
 - Verify the pairing PIN is the same on both devices, and then tap **Pair**.

OR

- If the pairing request requires a PIN, enter the **PIN**, and then tap **Pair**.

When the device is successfully paired with the computer, the device name appears under Paired devices.

6. (Optional) Once paired to a device, you can connect manually to the device. Tap the device under Paired devices. The word “Connected” appears under the paired device name.

The status icon changes from  to .

- To disconnect a paired device, tap the name of the paired device and then tap **Forget**.

Rename the Computer



You can change the name of the computer to make it easier to identify when pairing with other Bluetooth enabled devices and view statistics about received files.

1. Swipe up from the bottom of the Home screen to access all apps.
2. Tap **Settings**  > **Connected devices** > **Connection preferences** > **Bluetooth**.
3. Tap **Device Name**. Type the new name and then tap **Rename**.

Rename, Share or Unpair a Paired Device

You can rename a paired device to make it easier to identify it on the list or unpair the device to remove it from the paired list.

1. Swipe up from the bottom of the Home screen to access all apps.
2. Tap **Settings**  > **Connected devices** > **Previously connected devices**.

3. Tap  next to the paired device.
4. Take one of the following actions:
 - To rename the device, tap the Edit icon , type the new name, and then tap **RENAME**.
 - To allow **Internet access** or **Contact sharing**, tap the check box next to the setting.
 - To unpair the device, tap **Forget**.

About the Scanner Edge App



Your mobile computer is equipped to communicate with scanners using Bluetooth technology through the Scanner Edge app. The Bluetooth radio must be turned on. System bar icons indicate Bluetooth radio status.

To turn on the Bluetooth radio:

1. Swipe up from the bottom of the Home screen to access all apps.
2. Tap **Settings**  > **Connected devices** > **Connection preferences** > **Bluetooth**.
3. If necessary, tap **Use Bluetooth** to toggle the Bluetooth radio on.

Connect a Bluetooth Scanner

To connect to a Bluetooth scanner, the Bluetooth radio must be turned on and then scan a pairing barcode with the Bluetooth scanner.

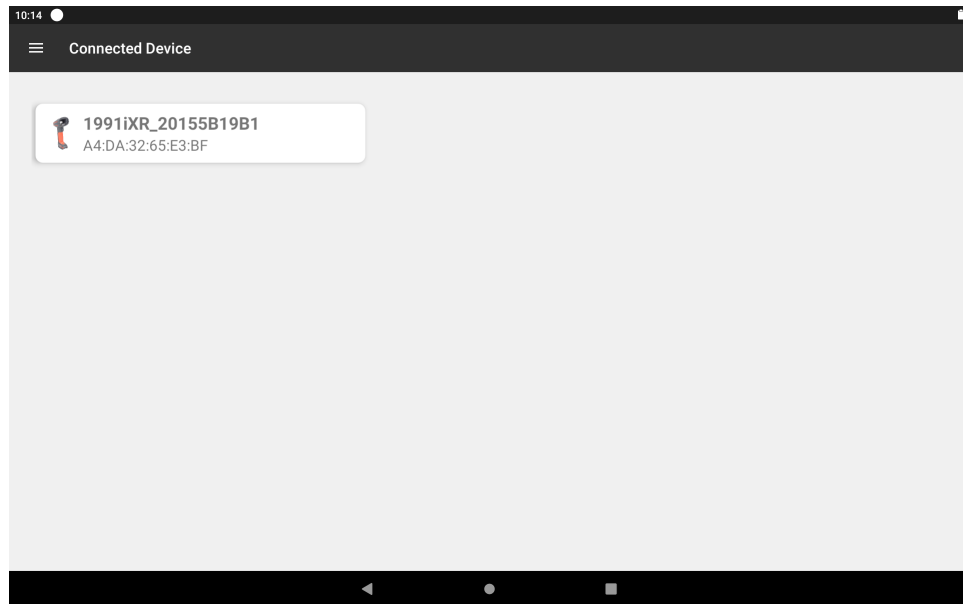

1. Swipe up from the bottom of the Home screen to access all apps.
2. Tap **Scanner Edge** .
3. Tap the menu icon  and then tap **Pair BT Scanner**.
4. For Honeywell branded scanners tap **Honeywell** or for Intermec branded scanners tap **Intermec**.
5. Scan the **Connect Barcode** displayed on screen.

- When the scanner is successfully paired with the computer, the scanner name appears under Connected Device.



Unpair a Paired Scanner

You can unpair the scanner to remove it from the Connected Device list.

- Swipe up from the bottom of the Home screen to access all apps.
- Tap **Scanner Edge** .
- Tap the menu icon  and then tap **Disconnect BT Scanner**.
- Tap **Honeywell** or **Intermec**.
- Scan the **Disconnect Barcode** displayed on screen.

About Serial and USB Communications

You can use optional accessories to transmit data to and receive data from another device through serial or USB communications.

For more information, see the *EDA10A Accessories User Guide*, available on the EDA10A product page at sps.honeywell.com or contact your local sales representative.

USB Troubleshooting

- If you have a problem with your workstation computer recognizing the USB device, try downloading and installing the Honeywell-aidc-usb-driver. The

driver is part of the Honeywell_Mobility SDK_Android software.zip file. To learn where to get the software, see [Developer Information](#) on page 78.

- Check to make sure you have enabled the USB for file transfer. To learn more, see [Configure USB Connection and Transfer Files](#) on page 20

About Near Field Communication (NFC)

NFC technology provides the ability for short-range, wireless data transfer between the EDA10A and NFC tags or other NFC enabled devices placed in close proximity to the back of the computer. All EDA10A mobile computers support the following modes of operation:

- NFC tag reader/writer mode: The computer reads and/or writes digital information from or to an NFC tag.
- Peer-to-Peer (P2P) mode: The computer uses Bluetooth technology to transfer screen content (e.g., a picture, contact information, Web page url, or file) between NFC enabled devices.
- NFC card emulation mode: The computer emulates an NFC card (smart card) that an external card reader can access. You can download and install apps for card emulation mode from the Google Play Store. Some examples include digital wallets (e-wallets) offered by your bank or credit card company and Google Pay.

Note: EDA10A only supports Host-based Card Emulation.

To read an NFC tag, bring the tag near the NFC antenna location on the mobile computer until the NFC tag is detected.

NFC is on by default. To turn NFC on or off, open the Settings app then select **Connected devices > Connection Preferences > NFC**.

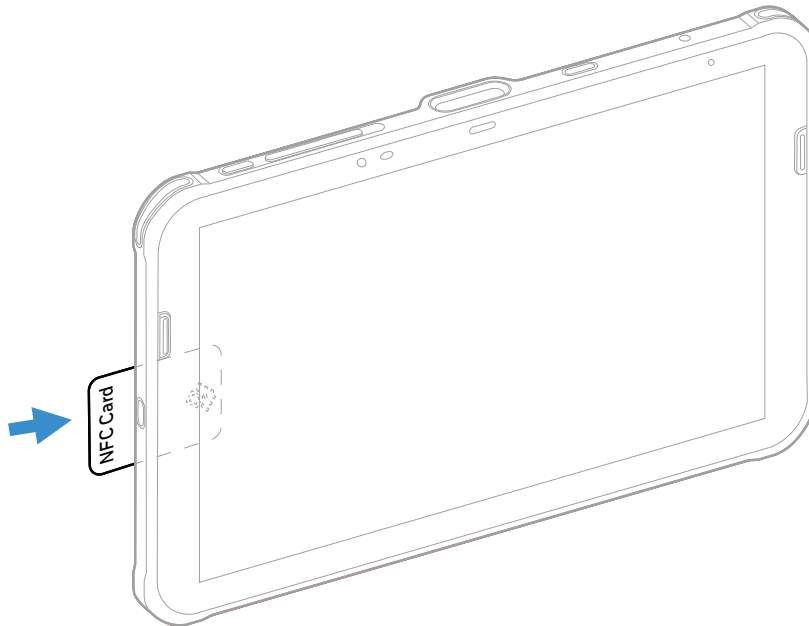

Developer Information

To download the Honeywell Mobility SDK for Android and EZConfig for Mobility:

1. Go to the Honeywell Technical Support Downloads Portal at honeywell.com/PSStechnicalsupport.
2. Create an account if you have not already created one. You must login to download the software.
3. Install the *Honeywell Download Manager* tool on your workstation (e.g., laptop or desktop computer) prior to trying to download any files.
4. Navigate to the software:
 - *Honeywell Mobility SDK for Android*
Click on **Software** > **Software and Tools** > **Developer Library** > **SDKs for Android**.
 - *EZConfig for Mobility*
Click on **Software** > **Software and Tools** > **EZConfig for Mobility**.
5. Select **Download** next to the software zip file.

About Provisioning Mode

Once you complete the out-of-box initial setup process, Provisioning mode is automatically turned Off to improve device security against unwanted modifications to the system.

When Provisioning mode is turned Off (disabled):

- Configuration barcodes do not scan and process.
- \honeywell\autoinstall folders are inaccessible.

Note: To learn more about network and security for Honeywell mobile computers with Android operating systems, go to sps.honeywell.com.

Enable or Disable Provisioning Mode

1. Swipe up from the bottom of the Home screen to access all apps.
2. Tap **Settings**  > **Honeywell Settings** > **Provisioning mode**.
3. Tap the button to toggle the provisioning On or Off.

MANAGE AND MAINTAIN THE COMPUTER

Use this chapter to understand how to upgrade software, reset, and maintain the computer.

About Software Updates and Cyber Security

Cyber security best practices include keeping your device apps and OS up to date. To help, Honeywell offers maintenance patches, security updates and operating system upgrades through our Honeywell Edge services.

Availability and cost depend on the following:

- Date of purchase of the device or software app.
- Warranty status.
- Service agreement status (devices) or Maintenance plan status (apps).

To learn more about Honeywell Edge Services, go to sps.honeywell.com and select **Services > Productivity > Support Services**.



Caution: Honeywell recommends routinely checking honeywell.com/SPS-cyber-security for critical Cyber Security Notifications and to download the latest Network and Security Guides.

Software Downloads

Product support is available online through [Technical Support](#). Software downloads can be accessed through the Software Downloads portal. You will need to create a login account for portal access. Additional information such as purchased date, service agreement number, maintenance plan number, or software license number may be required for downloads.

1. Go to honeywell.com/PSStechnicalsupport.
2. Create an account if you have not already created one.



3. Install the *Honeywell Download Manager* tool on your workstation (e.g., laptop or desktop computer) prior to trying to download. See “Note” on the portal page. This tool is required for downloads.
4. Locate the app or upgrade you want to download in the Software directory tree.
5. If prompted, enter additional information and click **Submit**.
6. Select **Download**. Follow the prompts to download the file.

About Transferring Files via USB Connection

If you plan on using a USB connection to transfer the upgrade files to the mobile computer, make sure you set the USB connection to allow file transfers. To learn more, see [Configure USB Connection and Transfer Files](#) on page 20.

Install Software with AutoInstall

Important: *The EDA10A must have power for the entire length of the install process or it could become unstable. Do not attempt to remove the battery during the process.*

1. Swipe up from the bottom of the Home screen to access all apps.
2. Tap **Settings**  > **Honeywell Settings** > **Provisioning mode**.
3. Tap the toggle button to turn Provisioning mode **On**.
4. Save the upgrade file (*.zip or *.apk) in one of the following folders on the EDA10A mobile computer:
 - **Internal shared storage\honeywell\autoinstall**
Software upgrades saved to this folder for installation, do not persist when an Erase all data (factory reset) or Enterprise data reset is performed.
 - **IPSM card\honeywell\autoinstall**
Software upgrades saved to this folder, do not persist when an Erase all data (factory reset) is performed. However, the upgrade does persist if an Enterprise data reset is performed.
5. Swipe up from the bottom of the Home screen to access all apps.
6. Tap **AutoInstall Settings**  and verify **Enable AutoInstall** is On .
7. Tap **Packages Update** from the AutoInstall Settings screen.



The computer automatically initiates a reboot and installs the software upgrade. The system update screen appears during the upgrade process. When the update is finished, the lock screen appears.
8. Once installation is complete, turn Provisioning mode Off.

Note: *Some updates do not require the computer to reboot before installation.*

Optional microSD Card Method

The EDA10A comes equipped with a microSD card socket. You can install an upgrade from a microSD card you insert in the computer.

Important: *The EDA10A must have power for the entire length of the install process or it could become unstable. Do not attempt to remove the battery during the process.*

1. On the EDA10A, swipe up from the bottom of the Home screen to access all apps.
2. Tap **Settings**  > **Honeywell Settings** > **Provisioning mode**.
3. Tap the toggle button to turn Provisioning mode **On**.
4. Tap **AutoInstall Settings** . Verify **Enable AutoInstall** is On .
5. Press and hold the **Power** button, and then tap **Power off**.
6. On your workstation (e.g., laptop, desktop computer), format the microSD card and create a **\honeywell\autoinstall** folder on the root of the card.
7. Save the upgrade file (*.zip or *.apk) file in the **autoinstall** folder.
8. Install the microSD card in the EDA10A, and then turn on the computer.

The computer automatically runs the upgrade found in the autoinstall folder on the card. The system update screen appears during the upgrade process. When the upgrade is finished, the lock screen appears.

9. Once installation is complete, turn Provisioning mode **Off**.

About the Honeywell Upgrader

Use the Honeywell Upgrader app (HUpgrader) to automatically search for and install Over-the-Air (OTA) operating system updates from a remote server. The app can also be used to manually initiate a search for OS updates, update the OS using a file downloaded to the mobile device, and downgrade the operating system to a previous version. Refer to the HUpgrader User Guide available at sps.honeywell.com for more information.

Restart (Reboot) the Computer

You may need to reboot the computer to correct conditions where an application stops responding to the system.

1. Save your files and close any open applications.
2. Press and hold the **Power** button until the options screen appears.
3. Tap **Restart**.

If the touch panel display is unresponsive:

- Press and hold the **Power** button for approximately 8 seconds until the computer reboots.

About Enterprise Data Reset

You can perform an Enterprise data reset if a Reboot did not improve the computer condition and all other troubleshooting methods have failed to resolve the issue. This method provides a clean configuration for troubleshooting by erasing all data from the **Internal shared storage** location on the computer. Data is not erased from the IPSM Card location.



Caution: An Enterprise data reset results in data loss. Only perform this procedure if all other recovery methods have failed. All personal content is erased including, but not limited to emails, pictures, contacts, Google account information, system settings and app settings.

Note: *This method of recovery may not be available if your system administrator has set policies to prevent the reset use.*

Before You Begin

- If you recently reset your Google Account password, wait 24 hours before performing an Enterprise data reset.
- Make sure you have your screen lock password, PIN or pattern if you activated one. You will need this to reset the computer.
- If you have a Google Account, back up your data and settings to your Google Account so you can restore them if needed.
- Connect the computer to an external power source or make sure you have a full battery charge.
- Make sure you have an Internet connection.

Enterprise Data Reset the Computer

1. Swipe up from the bottom of the Home screen to access all apps.
2. Select **Settings**  > **System** > **Advanced** > **Reset options**.
3. Tap **Enterprise data reset**.
4. Tap **Erase all data**.
5. If prompted, type your screen lock security pattern, PIN, or password and tap **NEXT**.

6. Tap **Erase all data**. A message appears informing you an Enterprise data reset is being performed.

About Erase All Data (Factory Reset)

A full Factory Reset should only be performed if you have exhausted all other troubleshooting options including an Enterprise data reset. This method reverts the computer back to the factory state by erasing all data in **Internal shared storage** and the **IPSM Card** storage locations on the computer.





Caution: A full Factory Reset results in data loss. Perform this procedure only if all other recovery methods have failed and have no other option. All personal content is erased including, but not limited to emails, pictures, contacts, Google account information, system settings and app settings.

Note: *This method of recovery may not be available if your system administrator has set policies to prevent the reset use.*

Before You Begin

- If you added a Google Account to the EDA10A Enterprise Tablet, make sure you have your Google username and password associated with the computer. If you do not have the username and password, you will not be able to use the computer after the reset. This is a security measure that prevents unauthorized users from using the device if they try a Full factory reset.
- If you did not add a Google Account to the computer, the extra security level is not enabled and you will not need a Google username and password.
- If you recently reset your Google Account password, wait 24 hours before performing a Full factory reset.
- Connect the computer to an external power source or make sure you have a full battery charge.
- Make sure you have an Internet connection.

Erase All Data (Factory Reset)

1. Swipe up from the bottom of the Home screen to access all apps.
2. Select **Settings**  > **System** > **Reset options**.
3. Tap **Erase all data (factory reset)**.
4. Tap **Erase all data**.
5. If prompted, type your screen lock security pattern, PIN, or password and tap next ().

6. Tap **Erase Everything**. A message appears informing you a Full factory reset is being performed.

Repairs

Repairs and/or upgrades are not to be performed on this product. These services are to be performed only by an authorized service center (see [Customer Support](#) on page vii).

Maintenance

Your device provides reliable and efficient operation with a minimum of care. Although specific maintenance is not required, the following section describes periodic checks to ensure dependable operation.

Clean the Tablet

The tablet housing, scanner window, camera window and touch screen may be cleaned with a soft cloth dampened with water. The touch screen can also be cleaned with isopropyl alcohol 70%.

Note: *Reading performance may degrade if the scanner window is not clean. If the window is visibly dirty, or if the scanner is not operating well, clean the window.*



Caution: **Do not submerge the tablet in water. Do not use abrasive wipes or cloths on the windows or touch screen. Abrasive wipes may scratch the windows and touch screen. Never use solvents (e.g., acetone) on the housing or windows. Solvents may damage the tablet finish, the windows or touch screen.**

Caution: **Ensure all components are dry prior to mating the tablet with charging accessories or other peripheral devices. Mating wet components may cause damage not covered by the warranty.**

Computer Agency Information

EDA10A Enterprise Tablets meet or exceed the requirements of all applicable standards organizations for safe operation. The best way to ensure safe operation is to use the mobile computer according to the agency guidelines on the product regulatory sheet, quick start guide, battery insert and in this user guide. Read all guidelines before using your computer.

Product documentation is available for download from sps.honeywell.com

Public certificates are available for download from honeywell.com/PSScompliance.

Label Locations

Labels inside the battery compartment contain information about the tablet including compliance information, model number, serial number and MAC address. Laser safety labeling is located on the back of the tablet.

Physical and Environmental Specifications

1. Go to sps.honeywell.com.
2. Type EDA10A in the Search box and then press **Enter**.
3. Click EDA10A Enterprise Tablet in the search results to access the product page, from which you can:
 - View System Architecture, Wireless Connectivity, Mechanical, and Environmental specifications.
 - Download the Data Sheet, Accessory Guide, Quick Start Guide, User Guide, Regulatory Information, Battery Information and other product documentation.

Barcode Symbologies Supported

The computer supports the following barcode symbologies:

1D Symbologies		2D Symbologies		Postal Codes	
	Default		Default		Default
Codabar	Enabled	Aztec Code	Enabled	China Post	Disabled
Code 39	Enabled	Codablock A	Disabled	Korean Post	Disabled
Code 11	Disabled	Codablock F	Disabled	2D Postal Settings	Disabled
Code 93	Disabled	DataMatrix	Enabled	Planet Code	Disabled
Code 128	Enabled	DotCode	Disabled	Postnet	Disabled
Composite	Disabled	Grid Matrix	Disabled		
EAN-8	Enabled	HanXin	Disabled		
EAN-13	Enabled	Maxicode	Disabled		
GS1-DataBar Limited	Disabled	Micro PDF 417	Enabled		
GS1 DataBar Omnidirectional	Disabled	PDF 417	Enabled		
GS1 DataBar Expanded	Enabled	QR Code	Enabled		
GS1-128	Enabled	TLC 39	Disabled		
IATA 2 of 5	Disabled	DigiMarc	Disabled		
Standard 2 of 5	Disabled	OCR	Disabled		
Interleaved 2 of 5	Enabled				
Matrix 2 of 5	Disabled				
MSI	Disabled				
Telepen	Disabled				
Trioptic	Disabled				
UPC-A	Enabled				
UPC/EAN	Disabled				
UPC-E	Enabled				
UPC-E1	Disabled				

S0703-SR (Standard Range) Imager

The depth of field measurements used the following parameters:

- Distances are measured from the front of the Imager.
- +23°C (+73°F), 0 lux for guaranteed, 200 lux for typical.
- Photographic quality codes

Note: *Time to Read and Depth of Field are impacted if the barcode symbol is at the edge of the image.*

Guaranteed Specs

Focus		Standard Range	
Symbology		Near Distance	Far Distance
5 mils Code 39	mm	79	270
	in.	3.11	10.63
10 mils Code 39	mm	40	425
	in.	1.57	16.73
20 mils Code 39	mm	44	674
	in.	1.73	26.53
13 mils 100% UPC-A	mm	44	493
	in.	1.73	19.41
15 mils Code 128	mm	42	572
	in.	1.65	22.52
10 mils Data Matrix	mm	83.1	236
	in.	3.27	9.29
6.7 mils PDF 417	mm	96.01	236
	in.	3.78	9.29
15 mils QR	mm	39	390
	in.	1.54	15.35

Typical Specs

Focus		Standard Range	
Symbology		Near Distance	Far Distance
5 mils Code 39	mm	70	301
	in.	2.75	11.85
10 mils Code 39	mm	40	517
	in.	1.57	20.35
20 mils Code 39	mm	44	800
	in.	1.73	31.5
13 mils 100% UPC-A	mm	44	573
	in.	1.73	22.56
15 mils Code 128	mm	42	650
	in.	1.65	25.59
10 mils Data Matrix	mm	72	297
	in.	2.83	11.69
6.7 mils PDF 417	mm	84	244
	in.	3.31	9.61
15 mils QR	mm	39	414
	in.	1.54	16.30

S0703 Imager Field of View/Resolution

Focus	Standard Range (SR)
Horizontal Field Angle (degrees)	44 ± 2°
Vertical Field Angle (degrees)	28 ± 2°

DPI can be calculated based on the following formula:

Horizontal DPI = 1280 pixels/width of horizontal field of view (inches)

Vertical DPI = 800 pixels/width of vertical field of view (inches)

Honeywell
855 S. Mint Street
Charlotte, NC 28202

sps.honeywell.com