

Mounting options

FOLLOW STAND
MOUNTING INSTRUCTIONS
(SUPPLIED WITH STANDS)

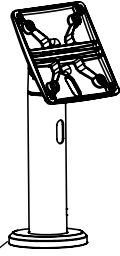

Or

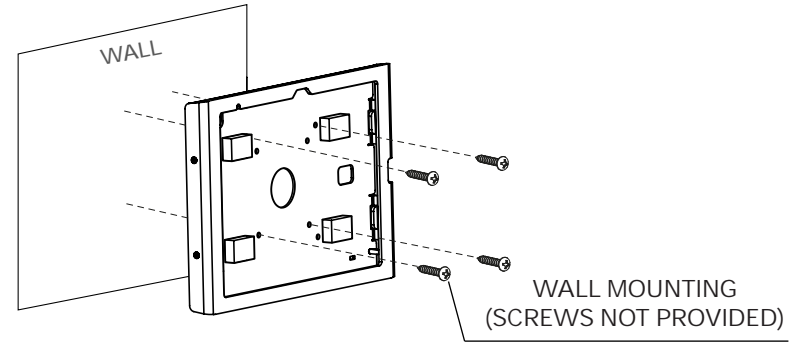

1

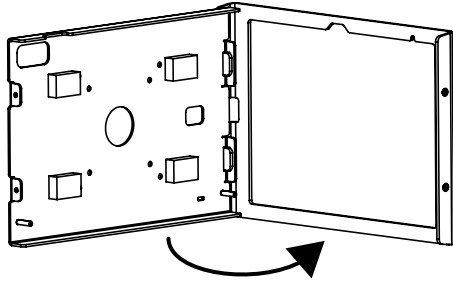

2

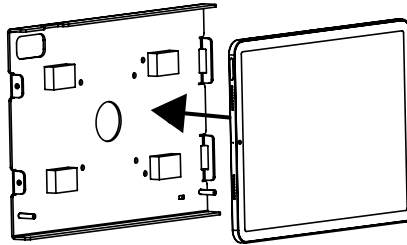

3

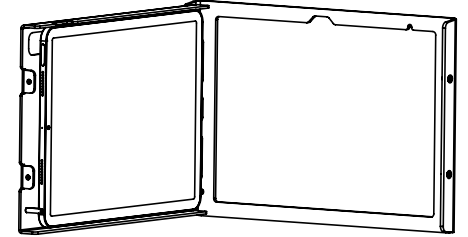

4

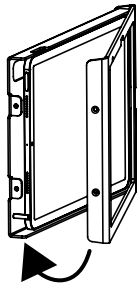

5

Secure with
M3 screws (provided)

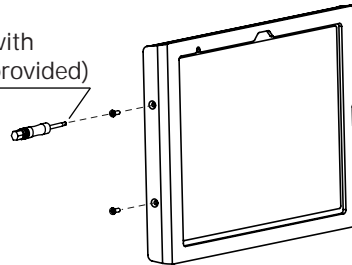

6

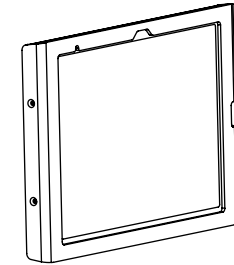

IN THE BOX



Torx Screwdriver



M3x10mm tamper proof screws

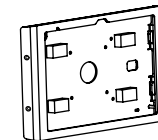

Swell enclosure