



# Intel Z790/H770/B760 Series Motherboard

## Software/BIOS Setup Guide

Version 1.0

Published September 2022

Copyright©2022 ASRock INC. All rights reserved.

Version 1.0

Published September 2022

Copyright©2022 ASRock INC. All rights reserved.

## Copyright Notice:

No part of this documentation may be reproduced, transcribed, transmitted, or translated in any language, in any form or by any means, except duplication of documentation by the purchaser for backup purpose, without written consent of ASRock Inc.

Products and corporate names appearing in this documentation may or may not be registered trademarks or copyrights of their respective companies, and are used only for identification or explanation and to the owners' benefit, without intent to infringe.

## Disclaimer:

Specifications and information contained in this documentation are furnished for informational use only and subject to change without notice, and should not be construed as a commitment by ASRock. ASRock assumes no responsibility for any errors or omissions that may appear in this documentation.

With respect to the contents of this documentation, ASRock does not provide warranty of any kind, either expressed or implied, including but not limited to the implied warranties or conditions of merchantability or fitness for a particular purpose.

In no event shall ASRock, its directors, officers, employees, or agents be liable for any indirect, special, incidental, or consequential damages (including damages for loss of profits, loss of business, loss of data, interruption of business and the like), even if ASRock has been advised of the possibility of such damages arising from any defect or error in the documentation or product.

## Contact Information:

If you need to contact ASRock or want to know more about ASRock, you're welcome to visit ASRock's website at <http://www.asrock.com>; or you may contact your dealer for further information. For technical questions, please submit a support request form at <https://event.asrock.com/tsd.asp>

### **ASRock Incorporation**

e-mail: [info@asrock.com.tw](mailto:info@asrock.com.tw)

### **ASRock EUROPE B.V.**

e-mail: [sales@asrock.nl](mailto:sales@asrock.nl)

### **ASRock America, Inc.**

e-mail: [sales@asrockamerica.com](mailto:sales@asrockamerica.com)

# Contents

<b>Chapter 1 Introduction</b>	<b>1</b>
<b>Chapter 2 Software and Utilities Operation</b>	<b>2</b>
2.1 Auto Driver Installer (ADI)	2
2.1.1 Installing Drivers for the First Time	2
2.1.2 Updating Drivers	6
2.2 ASRock Live Update & APP Shop	7
2.2.1 Installing ASRock Live Update & APP Shop	7
2.2.2 UI Overview	8
2.2.3 Apps	9
2.2.4 BIOS & Drivers	12
2.2.5 Setting	13
2.3 ASRock Motherboard Utility (A-Tuning)	14
2.3.1 Installing ASRock Motherboard Utility (A-Tuning)	14
2.3.2 Using ASRock Motherboard Utility (A-Tuning)	14
2.4 ASRock Motherboard Utility (Phantom Gaming Tuning)	17
2.4.1 Installing ASRock Motherboard Utility (Phantom Gaming Tuning)	17
2.4.2 Using ASRock Motherboard Utility (Phantom Gaming Tuning)	17
2.5 ASRock Polychrome SYNC	20
2.5.1 Connecting the LED Strip	20
2.5.2 Connecting the Addressable RGB LED Strip	21
2.5.3 Installing ASRock Polychrome SYNC Utility	22

2.6	Nahimic Audio	23
-----	---------------	----

## **Chapter 3 UEFI SETUP UTILITY** **25**

3.1	Introduction	25
3.1.1	Entering BIOS Setup	25
3.1.2	EZ Mode	26
3.1.3	Advanced Mode	27
3.1.4	UEFI Menu Bar	27
3.1.5	Navigation Keys	28
3.2	Main Screen (Advanced Mode)	29
3.3	OC Tweaker Screen	30
3.4	Advanced Screen	56
3.4.1	CPU Configuration	58
3.4.2	Chipset Configuration	61
3.4.3	Storage Configuration	66
3.4.4	Intel(R) Thunderbolt	68
3.4.5	Super IO Configuration	70
3.4.6	ACPI Configuration	71
3.4.7	USB Configuration	73
3.4.8	Trusted Computing	74
3.5	Tools	76
3.6	Hardware Health Event Monitoring Screen	78
3.7	Security Screen	86
3.8	Boot Screen	90
3.9	Exit Screen	93

# Chapter 1 Introduction

This user guide is a complete setup guide for all Intel Z790/H770/B760 motherboard series. The screenshots in this manual are for reference only. Settings and options may vary due to the motherboard you purchased.

In this documentation, Chapter 1 gives an overview of the setup guide. Chapter 2 contains the operation guide of the software and utilities. Chapter 3 contains the configuration guide of the BIOS setup.

## Software Setup Guide

- Auto Driver Installer (ADI)
- ASRock Live Update & APP Shop
- ASRock Motherboard Utility (A-Tuning)
- ASRock Motherboard Utility (Phantom Gaming Tuning)
- ASRock Polychrome SYNC
- Nahimic Audio

## BIOS Setup Guide

- UEFI Setup Utility



*Because the motherboard specifications and the software might be updated, the content of this documentation will be subject to change without notice. In case any modifications of this documentation occur, the updated version will be available on ASRock's website without further notice. If you require technical support related to this motherboard, please visit our website for specific information about the model you are using. ASRock website <http://www.asrock.com>.*

# Chapter 2 Software and Utilities Operation

## 2.1 Auto Driver Installer (ADI)

Optical drive or driver DVD is no longer needed for driver installation. ASRock motherboard already has its Ethernet driver prepacked in BIOS ROM. When you finish installing the operation system, simply use the Auto Driver Installer to download and install all necessary drivers automatically.

### 2.1.1 Installing Drivers for the First Time

Follow the instructions to install all necessary drivers via the Auto Driver Installer. Please note that the Internet access is required during the following procedures.

#### **Step 1**

After you install the Windows OS, connect your computer to the Internet.

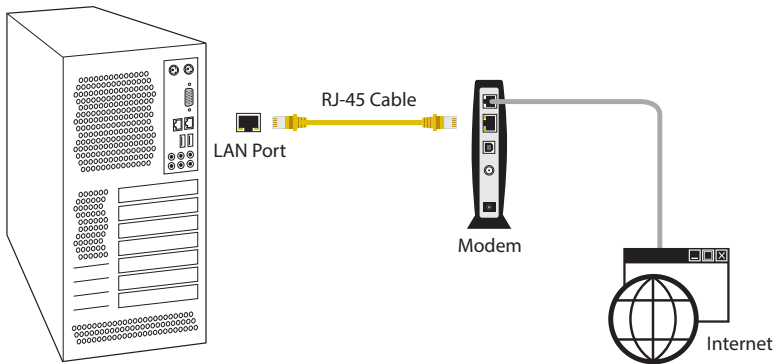

**Step 2**

Boot into the system, and a notification will pop up in the lower right corner of your screen saying, "**Do you want to one-step-install the latest drivers simply from ASRock Auto Driver Installer?**".

Select "Yes" to install Auto Driver Installer.

Select "No" to skip the installation.



1. The Auto Driver Installer will automatically pop up for users to install drivers only when the "Auto Driver Installer" item under the "Tool" menu in the BIOS is set to [Enabled]. The item is enabled by default; therefore, for the first-time users, there is no need to change the setting in the BIOS.
2. An available Internet connection is a prerequisite for using the Auto Driver Installer. If you boot into the system without Internet, the Auto Driver Installer won't appear. Now connect your computer to the Internet, wait a few seconds, and then the Auto Driver Installer will pop up.
3. If you select "No" in Step 2 and skip the installation, the Auto Driver Installer will be removed. If you would like to run the application again, please enable the "Auto Driver Installer" item in the BIOS setting.

**Step 3**

When it's completed, you will see the Auto Driver Installer icon on your desktop and then the Auto Driver Installer appears.



#### Step 4

The Auto Driver Installer panel lists all available drivers that your motherboard supports. Select one or more drivers to be installed.

Click "Select All" to select all items.

Click "Unselect All" to remove all of your selections.

Click "Update" to start downloading and installing drivers.

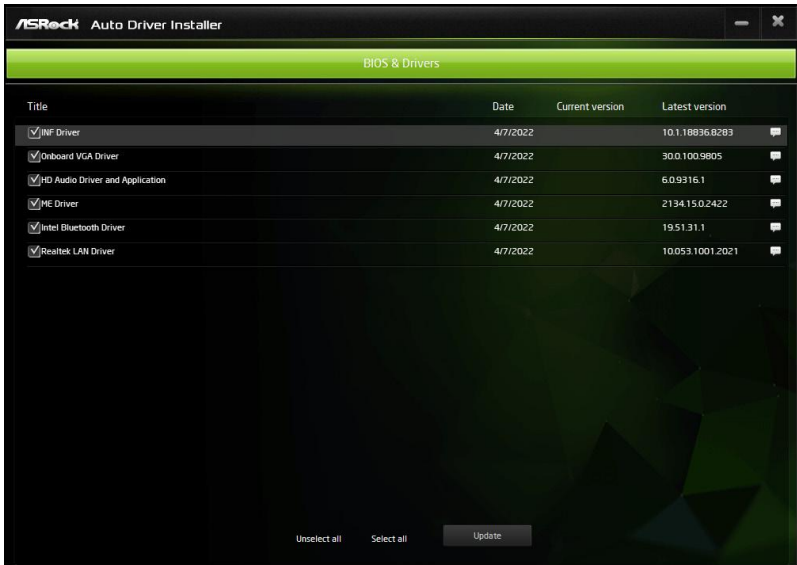

*If there are no drivers to be installed, click "Finish" to exit. If you would like to run the application again, please enable the "Auto Driver Installer" item in the BIOS setting.*



**Step 5**

A message pops up saying, "During installation, your system may reboot and continue installing remaining item(s)".

Click "Yes" to continue.

Click "No" to exit.

**Step 6**

Once all drivers are successfully installed, a message pops up saying, "Installation has been successfully completed! For further drivers and utilities, please visit ASRock's website."

Click "Ok" to complete the procedure.

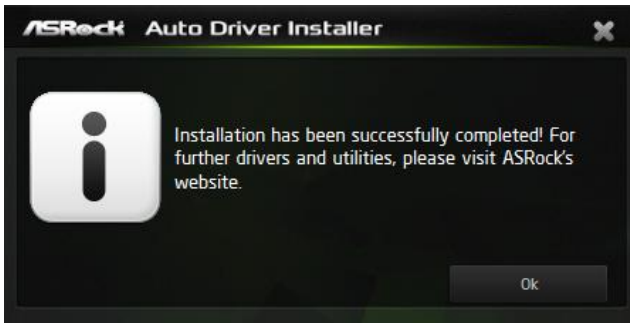

When driver installation is completed, the Auto Driver Installer tool will be uninstalled automatically from your computer.



*After driver installation, the Auto Driver Installer will be removed. If you would like to run the application again, please go to the "Tool" menu in the BIOS setting, and set the "Auto Driver Installer" item to [Enabled].*

## 2.1.2 Updating Drivers

Updating drivers ensures that your system work well without any issue. To update drivers, please go to ASRock' website (<https://www.asrock.com>) and select "Support" > "Latest Drivers Update".

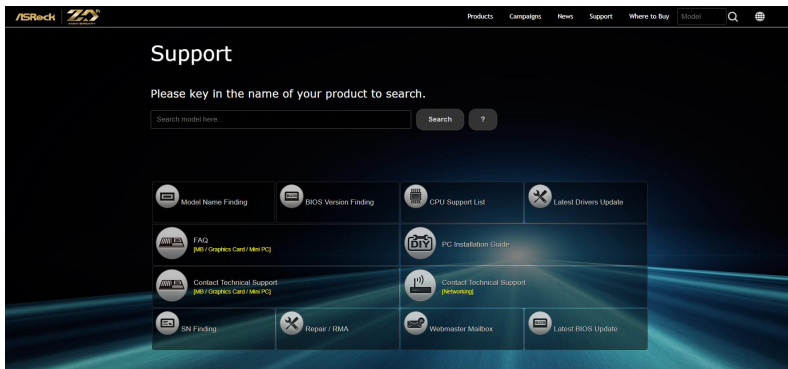

## 2.2 ASRock Live Update & APP Shop

The ASRock Live Update & APP Shop is an online store for purchasing and downloading software applications for your ASRock computer. You can quickly and easily install various apps and support utilities. With ASRock Live Update & APP Shop, you can optimize your system and keep your motherboard up to date simply with a few clicks.

### 2.2.1 Installing ASRock Live Update & APP Shop

Please download the ASRock Live Update & APP Shop utility from the ASRock's website: "https://www.asrock.com".

Go to the product page of your motherboard, select "Support" > "Download" to download the APP Shop.

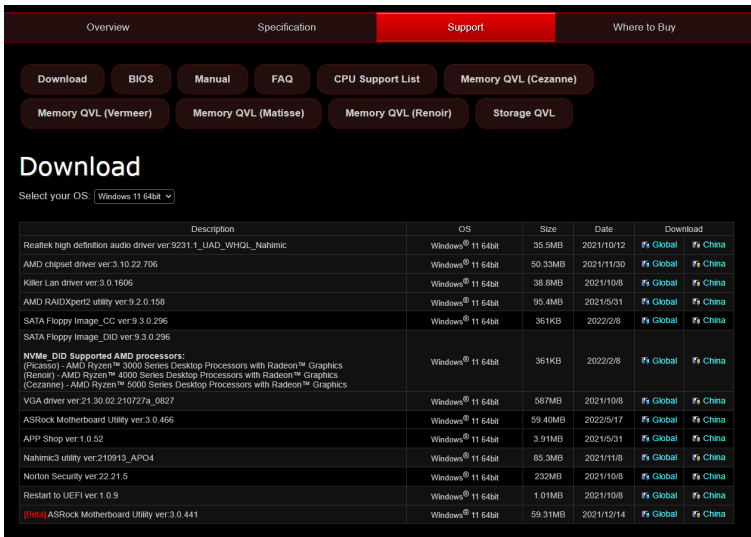

Description	OS	Size	Date	Download
Realtek high definition audio driver ver.9231.1_LIAD_WHQL_Nahimic	Windows® 11 64bit	35.5MB	2021/10/12	<a href="#">Global</a> <a href="#">China</a>
AMD chipset driver ver.3.10.22.706	Windows® 11 64bit	50.33MB	2021/11/30	<a href="#">Global</a> <a href="#">China</a>
Killer Lan driver ver.3.0.1606	Windows® 11 64bit	38.8MB	2021/10/8	<a href="#">Global</a> <a href="#">China</a>
AMD RAIDXpert2 Utility ver.9.2.0.158	Windows® 11 64bit	95.4MB	2021/5/31	<a href="#">Global</a> <a href="#">China</a>
SATA Floppy Image_CC ver:9.3.0.296	Windows® 11 64bit	361KB	2022/2/8	<a href="#">Global</a> <a href="#">China</a>
SATA Floppy Image_DID ver:9.3.0.296	Windows® 11 64bit	361KB	2022/2/8	<a href="#">Global</a> <a href="#">China</a>
<b>NVMe_DID Supported AMD processors:</b> (Renoir) - AMD Ryzen™ 5000 Series Desktop Processors with Radeon™ Graphics (Renoir) - AMD Ryzen™ 4000 Series Desktop Processors with Radeon™ Graphics (Cezanne) - AMD Ryzen™ 5000 Series Desktop Processors with Radeon™ Graphics	Windows® 11 64bit	361KB	2022/2/8	<a href="#">Global</a> <a href="#">China</a>
VGA driver ver.21.30.02.210727a_0827	Windows® 11 64bit	587MB	2021/10/8	<a href="#">Global</a> <a href="#">China</a>
ASRock Motherboard Utility ver.3.0.466	Windows® 11 64bit	59.40MB	2022/5/17	<a href="#">Global</a> <a href="#">China</a>
APP Shop ver.1.0.52	Windows® 11 64bit	3.91MB	2021/5/31	<a href="#">Global</a> <a href="#">China</a>
Nahimic3 Utility ver.210913_APO4	Windows® 11 64bit	85.3MB	2021/11/8	<a href="#">Global</a> <a href="#">China</a>
Norton Security ver.22.21.5	Windows® 11 64bit	232MB	2021/10/8	<a href="#">Global</a> <a href="#">China</a>
Restart to UEFI ver.1.0.9	Windows® 11 64bit	1.01MB	2021/10/8	<a href="#">Global</a> <a href="#">China</a>
[Beta] ASRock Motherboard Utility ver.3.0.441	Windows® 11 64bit	59.31MB	2021/12/14	<a href="#">Global</a> <a href="#">China</a>

After installation, double-click  on your desktop to access ASRock Live Update & APP Shop utility.

*\*You need to be connected to the Internet to download apps from the ASRock Live Update & APP Shop.*

## 2.2.2 UI Overview

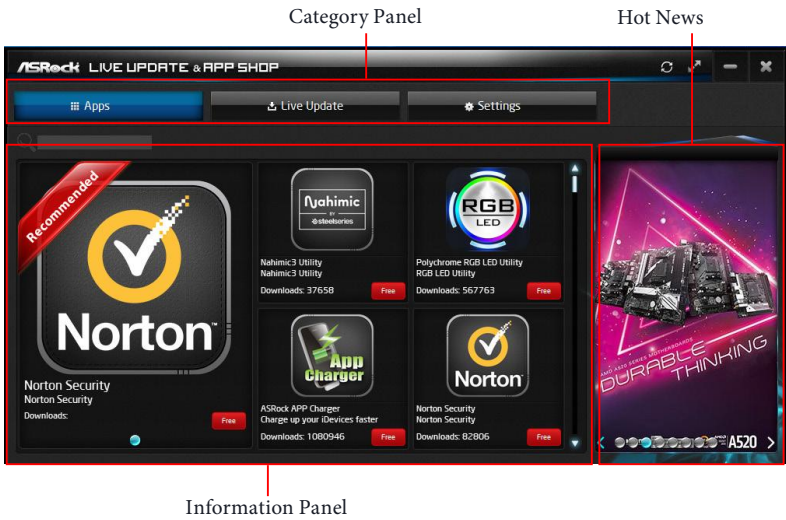

**Category Panel:** The category panel contains several category tabs or buttons that when selected the information panel below displays the relative information.

**Information Panel:** The information panel in the center displays data about the currently selected category and allows users to perform job-related tasks.

**Hot News:** The hot news section displays the various latest news. Click on the image to visit the website of the selected news and know more.

## 2.2.3 Apps

When the "Apps" tab is selected, you will see all the available apps on screen for you to download.

### Installing an App

#### Step 1

Find the app you want to install.

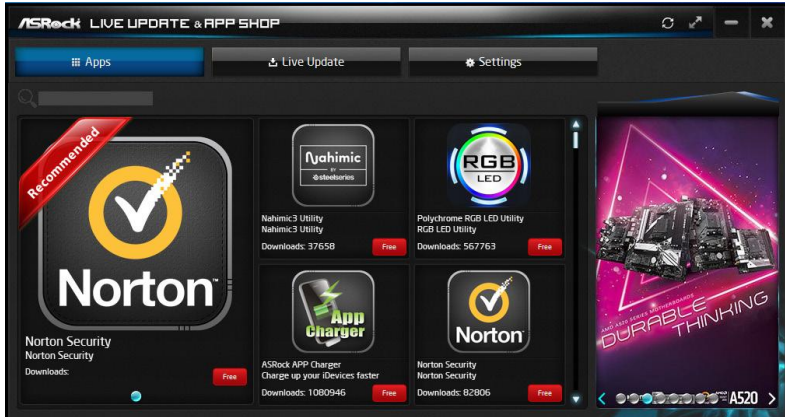

The most recommended app appears on the left side of the screen. The other various apps are shown on the right. Please scroll up and down to see more apps listed.

You can check the price of the app and whether you have already installed it or not.

**Free** - The red icon displays the price or "Free" if the app is free of charge.

**Installed** - The green "Installed" icon means the app is installed on your computer.

#### Step 2

Click on the app icon to see more details about the selected app.

### Step 3

If you want to install the app, click on the red icon  to start downloading.



### Step 4

When installation completes, you can find the green "Installed" icon appears on the upper right corner.

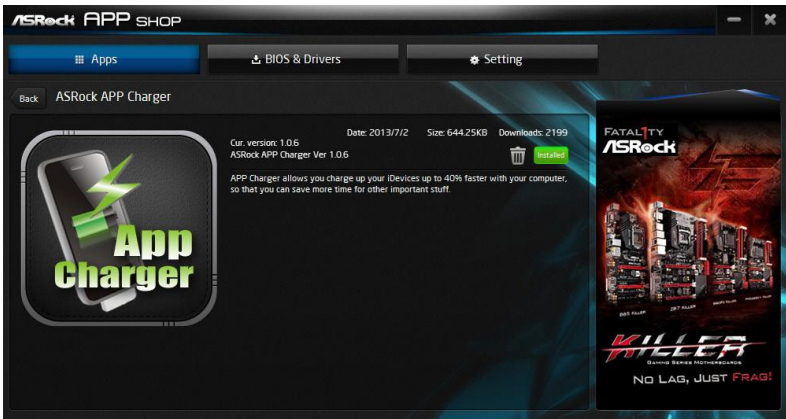

To uninstall it, simply click on the trash can icon .

\*The trash icon may not appear for certain apps.

## Upgrading an App

You can only upgrade the apps you have already installed. When there is an available new version for your app, you will find the mark of "New Version"  appears below the installed app icon.



### Step 1

Click on the app icon to see more details.

### Step 2

Click on the yellow icon  to start upgrading.

## 2.2.4 BIOS & Drivers

### Installing BIOS or Drivers

When the "BIOS & Drivers" tab is selected, you will see a list of recommended or critical updates for the BIOS or drivers. Please update them all soon.

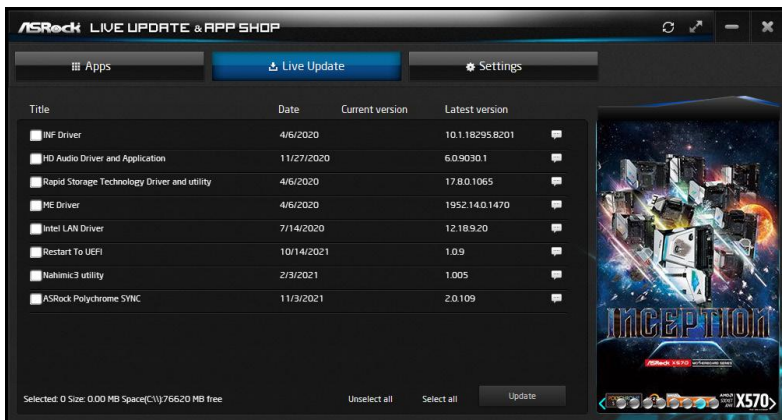

#### **Step 1**

Please check the item information before update. Click on  to see more details.

#### **Step 2**

Click to select one or more items you want to update.

#### **Step 3**

Click Update to start the update process.



## 2.2.5 Setting

In the "Setting" page, you can change the language, select the server location, and determine if you want to automatically run the ASRock Live Update & APP Shop on Windows startup.

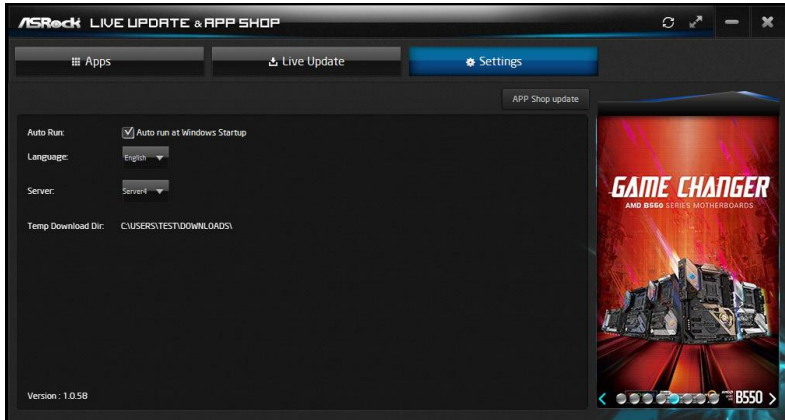

## 2.3 ASRock Motherboard Utility (A-Tuning)

ASRock Motherboard Utility (A-Tuning) is ASRock's multi purpose software suite with a new interface, more new features and improved utilities.

### 2.3.1 Installing ASRock Motherboard Utility (A-Tuning)

ASRock Motherboard Utility (A-Tuning) can be downloaded from ASRock Live Update & APP Shop.

You can also download the utility from the ASRock's website: "<https://www.asrock.com>". Go to the product page of your motherboard, select "Support" > "Download" to download "ASRock Motherboard Utility".

After the installation, you will find the icon "ASRock Motherboard Utility (A-Tuning)" on your desktop. Double-click the "ASRock Motherboard Utility (A-Tuning)" icon , ASRock Motherboard Utility (A-Tuning) main menu will pop up.

### 2.3.2 Using ASRock Motherboard Utility (A-Tuning)

There are five sections in ASRock Motherboard Utility (A-Tuning) main menu: Operation Mode, OC Tweaker, System Info, FAN-Tastic Tuning and Settings.

#### Operation Mode

Choose an operation mode for your computer.

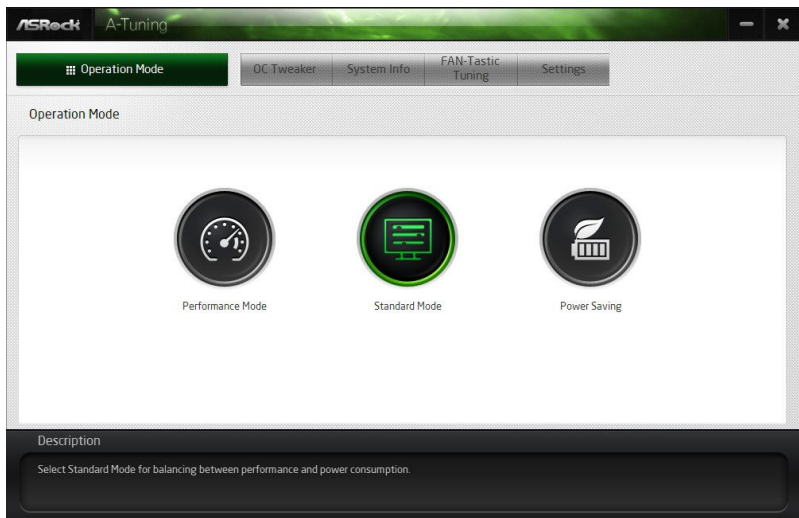

## OC Tweaker

Configurations for overclocking the system.

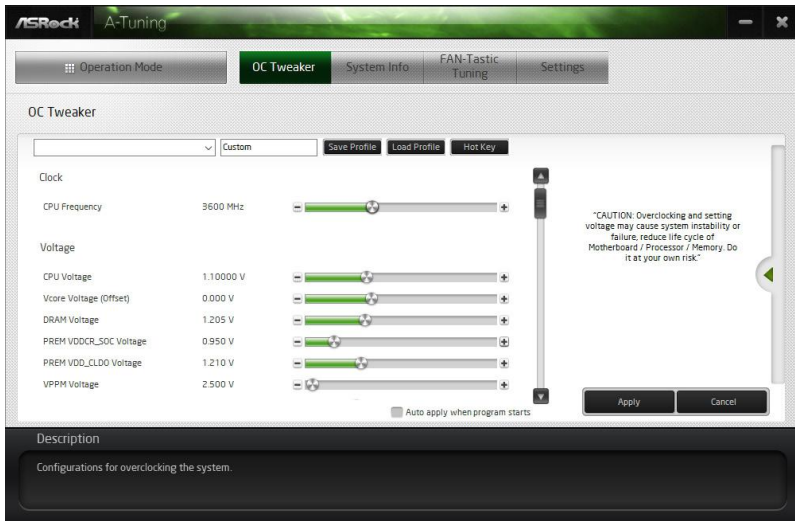

## System Info

View information about the system.

\*The System Browser tab may not appear for certain models.

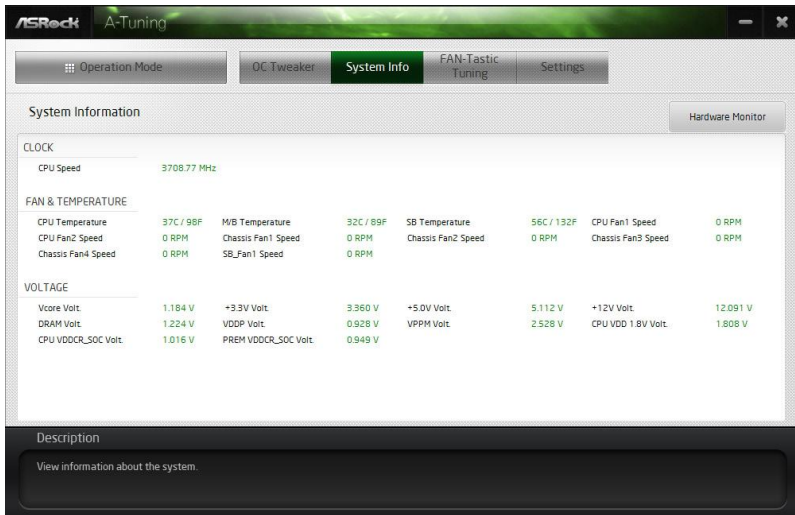

## FAN-Tastic Tuning

Configure up to five different fan speeds using the graph. The fans will automatically shift to the next speed level when the assigned temperature is met.

**FAN-Tastic Tuning**

CPU FAN1

Start FAN Test

Fan Power	Fan Speed
100%	N/A RPM
90%	N/A RPM
80%	N/A RPM
70%	N/A RPM
60%	N/A RPM
50%	N/A RPM
40%	N/A RPM
30%	N/A RPM
20%	N/A RPM
10%	N/A RPM

Auto apply when program starts

Apply Cancel

**Description**

Configure different fan speeds for respective temperatures using the graph. The fans will automatically shift to the next speed level when the assigned temperature is met.

## Settings

Configure ASRock ASRock Motherboard Utility (A-Tuning). Click to select "Auto run at Windows Startup" if you want ASRock Motherboard Utility (A-Tuning) to be launched when you start up the Windows operating system.

**Settings**

Auto run at Windows Startup

**Description**

Configure ASRock A-Tuning.

Version : 3.0.466

## 2.4 ASRock Motherboard Utility (Phantom Gaming Tuning)

ASRock Motherboard Utility (Phantom Gaming Tuning) is ASRock's multi purpose software suite with a new interface, more new features and improved utilities.

### 2.4.1 Installing ASRock Motherboard Utility (Phantom Gaming Tuning)

ASRock Motherboard Utility (Phantom Gaming Tuning) can be downloaded from ASRock Live Update & APP Shop.

You can also download the utility from the ASRock's website: "<https://www.asrock.com>". Go to the product page of your motherboard, select "Support" > "Download" to download "ASRock Motherboard Utility".

After the installation, you will find the icon "Phantom Gaming Tuning" on your desktop. Double-click the "Phantom Gaming Tuning"  icon, Phantom Gaming Tuning main menu will pop up.

### 2.4.2 Using ASRock Motherboard Utility (Phantom Gaming Tuning)

There are five sections in ASRock Motherboard Utility (Phantom Gaming Tuning) main menu: Operation Mode, OC Tweaker, System Info, FAN-Tastic Tuning and Settings.

#### Operation Mode

Choose an operation mode for your computer.

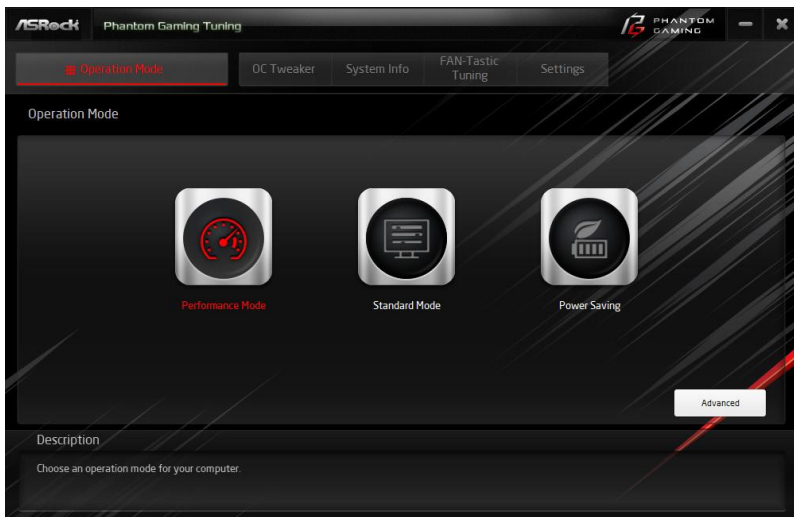

## OC Tweaker

Configurations for overclocking the system.



## System Info

View information about the system.

\*The System Browser tab may not appear for certain models.

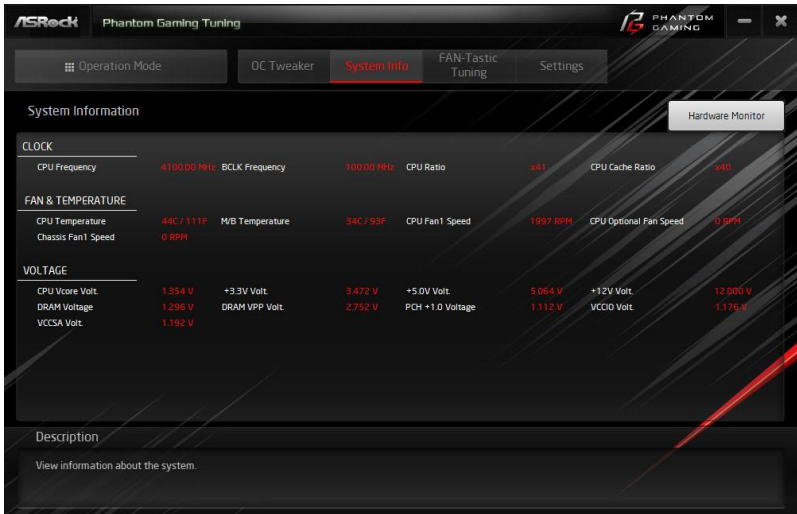

## FAN-Tastic Tuning

Configure up to five different fan speeds using the graph. The fans will automatically shift to the next speed level when the assigned temperature is met.

The screenshot displays the ASRock Phantom Gaming Tuning software interface, specifically the FAN-Tastic Tuning section. The window title is "ASRock Phantom Gaming Tuning". The "FAN-Tastic Tuning" tab is selected, showing a graph of Fan Speed (RPM) on the y-axis (0 to 100) and Temperature (C) on the x-axis (0 to 100). A red line indicates the fan speed profile, which starts at 30 RPM at 50°C, rises to 45 RPM at 60°C, 70 RPM at 70°C, and reaches 100 RPM at 100°C. To the right of the graph is a table of Fan Power and Fan Speed settings:

Fan Power	Fan Speed
100%	N/A RPM
90%	N/A RPM
80%	N/A RPM
70%	N/A RPM
60%	N/A RPM
50%	N/A RPM
40%	N/A RPM
30%	N/A RPM
20%	N/A RPM
10%	N/A RPM

Below the table is an "Apply" button and a "Cancel" button. The "Settings" tab is also visible, showing "Auto run at Windows Startup" checked. The "Description" section at the bottom states: "Configure different fan speeds for respective temperatures using the graph. The fans will automatically shift to the next speed level when the assigned temperature is met."

## Settings

Configure ASRock Phantom Gaming Tuning. Click to select "Auto run at Windows Startup" if you want Phantom Gaming Tuning to be launched when you start up the Windows operating system.

The screenshot displays the ASRock Phantom Gaming Tuning software interface, specifically the Settings section. The window title is "ASRock Phantom Gaming Tuning". The "Settings" tab is selected, showing a checkbox for "Auto run at Windows Startup" which is checked. The "Description" section at the bottom states: "Configure ASRock Phantom Gaming." The version number "Version : 3.0.230" is visible in the bottom right corner.

## 2.5 ASRock Polychrome SYNC

ASRock Polychrome SYNC is a lighting control utility specifically designed for unique individuals with sophisticated tastes to build their own stylish colorful lighting system. Simply by connecting the LED strip, you can customize various lighting schemes and patterns, including Static, Breathing, Strobe, Cycling, Music, Wave and more.

### 2.5.1 Connecting the LED Strip

Connect your RGB LED strip to the **RGB LED Header** on the motherboard.

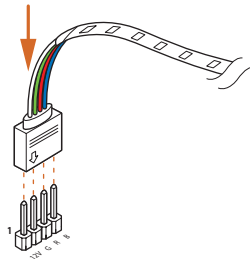

**RGB LED Header**



1. Never install the RGB LED cable in the wrong orientation; otherwise, the cable may be damaged.
2. Before installing or removing your RGB LED cable, please power off your system and unplug the power cord from the power supply. Failure to do so may cause damages to motherboard components.



1. Please note that the RGB LED strips do not come with the package.
2. The RGB LED header supports standard 5050 RGB LED strip (12V/G/R/B), with a maximum power rating of 3A (12V) and length within 2 meters.



## 2.5.2 Connecting the Addressable RGB LED Strip

Connect your Addressable RGB LED strip to the **Addressable LED Header** on the motherboard.

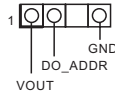
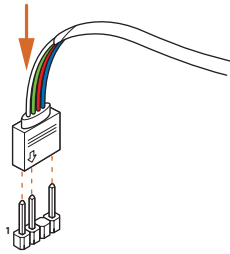

**Addressable LED Header**



1. Never install the RGB LED cable in the wrong orientation; otherwise, the cable may be damaged.
2. Before installing or removing your RGB LED cable, please power off your system and unplug the power cord from the power supply. Failure to do so may cause damages to motherboard components.



1. Please note that the RGB LED strips do not come with the package.
2. The RGB LED header supports WS2812B addressable RGB LED strip (5V/Data/GND), with a maximum power rating of 3A (5V) and length within 2 meters.

## 2.5.3 Installing ASRock Polychrome SYNC Utility

After connecting the required LED strips, download the ASRockPolychrome SYNC Utility from the ASRock Live Update & APP Shop. You can also download the utility from the ASRock's website: "<https://www.asrock.com>". Go to the product page of your motherboard, select "Support" > "Download" to download the ASRock Polychrome RGB.

Now you can adjust the RGB LED color through this utility and start coloring your PC style your way!

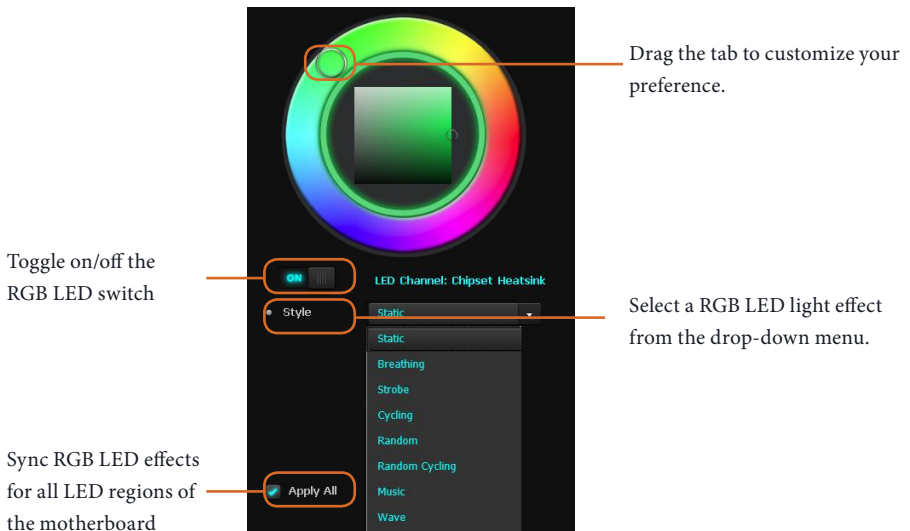

## 2.6 Nahimic Audio

Nahimic audio software provides an incredible high definition sound technology which boosts the audio and voice performance of your system. Nahimic Audio interface is composed of four tabs: Audio, Microphone, Sound Tracker and Settings.

Download this utility from the ASRock Live Update & APP Shop. You can also download the utility from the ASRock's website: "<https://www.asrock.com>". Go to the product page of your motherboard, select "Support" > "Download" to download the Nahimic utility.

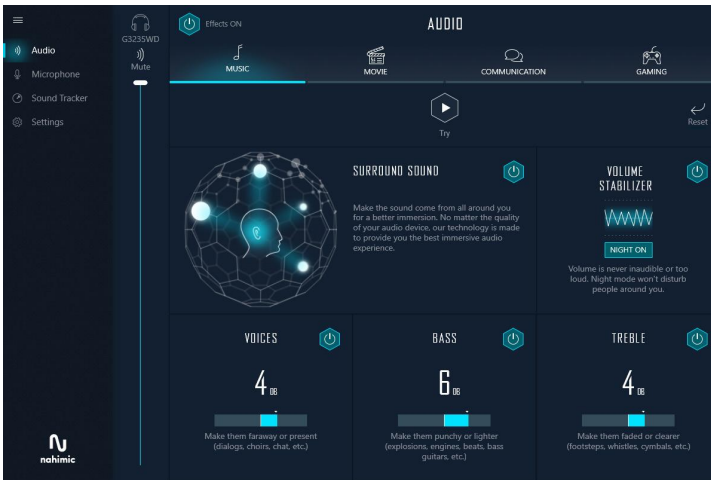

There are four functions in Nahimic audio:

No.	Function	Description
1	Audio	From this tab, you can mute the current audio device, choose between four factory audio profiles, turn all audio effects on/off, restores the current profile to its default settings and access Surround Sound and various features.
2	Microphone	From this tab, you can mute the current mic device, choose between two factory mic profiles, turn/off all microphone effects, restore the current profile to its default settings, and access Static Noise Suppression and various features.
3	Sound Tracker	The Sound Tracker provides a visual indication localizing the sources of the sounds while in a game. These are represented by dynamic segments pointing the direction of the sounds: the more opaque they are, the stronger the sounds are.

- 
- 4**      Settings      From this tab, you can access all settings and information of the software.

## Chapter 3 UEFI SETUP UTILITY

### 3.1 Introduction

ASRock UEFI (Unified Extensible Firmware Interface) is a BIOS utility which offers tweak-friendly options in an advanced viewing interface. The UEFI system works with a USB mouse and offers users a faster, sleeker experience.

This BIOS utility can perform the Power-On Self-Test (POST) during system startup, record hardware parameters of the system, load operating system, and so on. The battery on the motherboard supplies the power needed to the CMOS when the system power is turned off, and the values configured in the UEFI utility are kept in the CMOS.

Please note that inadequate BIOS settings may cause system instability, malfunction or boot failure. We strongly recommend that you do not alter the UEFI default configurations or change the settings only with the assistance of a trained service person.

If the system becomes unstable or fails to boot after you change the setting, try to clear the CMOS values and reset the board to default values. See your motherboard manual for instructions.

#### 3.1.1 Entering BIOS Setup

You may run the UEFI SETUP UTILITY by pressing <F2> or <Del> right after you power on the computer; otherwise, the Power-On-Self-Test (POST) will continue with its test routines. If you wish to enter the UEFI SETUP UTILITY after POST, restart the system by pressing <Ctl> + <Alt> + <Delete>, or by pressing the reset button on the system chassis. You may also restart by turning the system off and then back on.

This setup guide explains how to use the UEFI SETUP UTILITY to configure all the supported system. The screenshots in this manual are for reference only. UEFI Settings and options may vary owing to different BIOS release versions or CPU installed. Please refer to the actual BIOS version of the motherboard you purchased for detailed screens, settings and options.

## 3.1.2 EZ Mode

The EZ Mode screen appears when you enter the BIOS setup program by default. EZ mode is a dashboard which contains multiple readings of the system's current status. You can check the most crucial information of your system, such as CPU speed, DRAM frequency, SATA information, fan speed, etc.

Press <F6> or click the "Advanced Mode" button at the upper right corner of the screen to switch to "Advanced Mode" for more options.

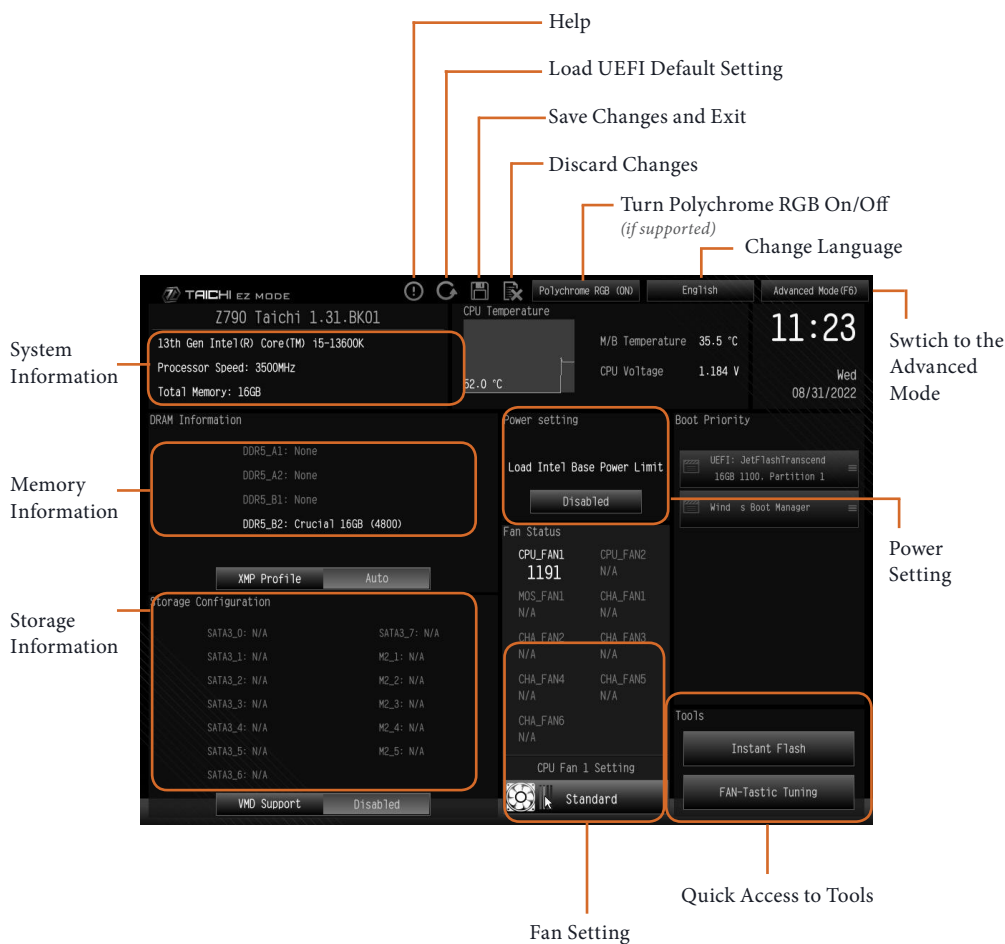

### 3.1.3 Advanced Mode

The Advanced Mode provides more options to configure the BIOS settings. Refer to the following sections for the detailed configurations.

To access the EZ Mode, press <F6> or click the "EZ Mode" button at the upper right corner of the screen.

### 3.1.4 UEFI Menu Bar

The top of the screen has a menu bar with the following selections:

<b>Main</b>	For setting system time/date information
<b>OC Tweaker</b>	For overclocking configurations
<b>Advanced</b>	For advanced system configurations
<b>Tool</b>	Useful tools
<b>H/W Monitor</b>	Displays current hardware status
<b>Security</b>	For security settings
<b>Boot</b>	For configuring boot settings and boot priority
<b>Exit</b>	Exit the current screen or the UEFI Setup Utility



*Because the UEFI software is constantly being updated, the following UEFI setup screens and descriptions for reference purpose only, and may vary from the latest BIOS and do not exactly match what you see on your screen.*



*Please realize that there is a certain risk involved with overclocking, including adjusting the setting in the BIOS, applying Untied Overclocking Technology, or using third-party overclocking tools. Overclocking may affect your system's stability, or even cause damage to the components and devices of your system. It should be done at your own risk and expense. We are not responsible for possible damage caused by overclocking.*

### 3.1.5 Navigation Keys

Use <←→> key or <→> key to choose among the selections on the menu bar, and use <↑> key or <↓> key to move the cursor up or down to select items, then press <Enter> to get into the sub screen. You can also use the mouse to click your required item.

Please check the following table for the descriptions of each navigation key.

Navigation Key(s)	Description
+ / -	To change option for the selected items
<Tab>	Switch to next function
<PGUP>	Go to the previous page
<PGDN>	Go to the next page
<HOME>	Go to the top of the screen
<END>	Go to the bottom of the screen
<F1>	To display the General Help Screen
<F7>	Discard changes and exit the SETUP UTILITY
<F9>	Load optimal default values for all the settings
<F10>	Save changes and exit the SETUP UTILITY
<F12>	Print screen
<ESC>	Jump to the Exit Screen or exit the current screen



## 3.2 Main Screen (Advanced Mode)

When you enter the UEFI SETUP UTILITY, the Main screen will appear and display the system overview.



### My Favorite

Display your collection of BIOS items. Press F5 to add/remove your favorite items.



*Because the UEFI software is constantly being updated, the following UEFI setup screens and descriptions are for reference purpose only, and they may not exactly match what you see on your screen. Options may also vary depending on the features of your motherboard.*

### 3.3 OC Tweaker Screen

In the OC Tweaker screen, you can set up overclocking features.

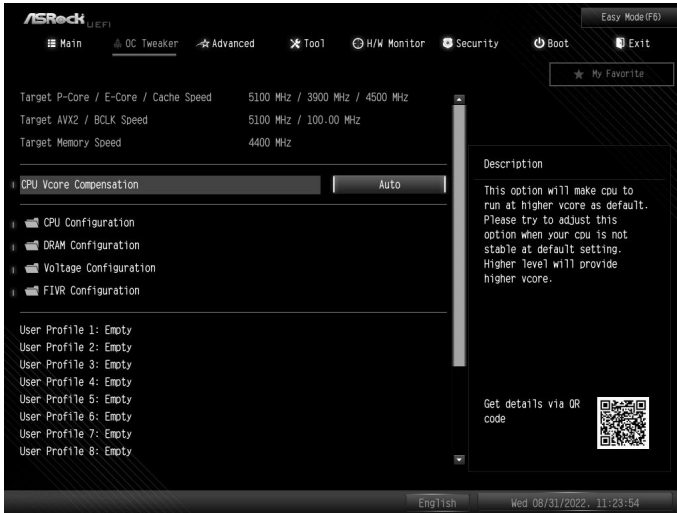

#### CPU Vcore Compensation

This option will make cpu to run at higher vcore as default. Please try to adjust this option when your cpu is not stable at default setting. Higher level will provide higher vcore.

Configuration options: [Auto] [Level 1] [Level 2] [Level 3] [Level 4] [Level 5]

#### Base Frequency Boost

Allows you to enjoy the base frequency boost with the hidden power of processors immediately. This item appears depending on the motherboard model you use.

#### CPU Configuration

#### CPU Turbo Ratio Information

Press [Enter] to view the CPU Turbo Ratio information.

#### CPU P-Core Ratio

The CPU speed is determined by the CPU P-Core Ratio multiplied with the BCLK. Increasing the CPU P-Core Ratio will increase the internal CPU clock speed without affecting the clock speed of other components.

Configuration options: [Auto] [All Core] [Per Core] [Specific Per Core]

## AVX2 Ratio Offset

AVX2 Ratio Offset specifies a negative offset from the CPU Ratio for AVX workloads. AVX is a more stressful workload that lower the AVX ratio to ensure maximum possible ratio for SSE workloads.

## CPU E-Core Ratio

The E-Core speed is determined by the E-Core Ratio multiplied with the BCLK. Increasing the E-Core Ratio will increase the internal E-Core clock speed without affecting the clock speed of other components.

Configuration options: [Auto] [All Core] [Per Core] [Specific Per Core]

## CPU Cache Ratio

The CPU Internal Bus Speed Ratio. The maximum should be the same as the CPU Ratio.

## Min Cache Ratio

The CPU internal bus speed minimum ratio. To align cache ratio with P-Core ratio for non-K CPU, you can try to sync Min Cache Ratio Limit with CPU Cache Ratio.

## GT Frequency

Allows you to configure the frequency of the integrated GPU in MHz. This item appears when you use the onboard graphics.

## CPU Flex Ratio Override

Allows you to enable or disable CPU Flex Ratio Programming. Flex Ratio can lower maximum non-turbo, especially for CPU without turbo function.

Configuration options: [Auto] [Enabled]

## CPU Flex Ratio

This value must be between Max Efficiency Ratio (LFM) and Maximum non-turbo ratio set by Hardware (HFM).

## BCLK Frequency

The CPU speed is determined by the CPU Ratio multiplied with the BCLK. Increasing the BCLK will increase the internal CPU clock speed but also affect the clock speed of other components.

## PEG/DMI Frequency

Allows you to configure the PEG/DMI Frequency.

## BCLK Advanced Setting

Press [Enter] to configure BCLK Advanced Setting.

## BCLK SSC Mode

Allows you configure BCLK Spread Spectrum Mode. The item appears when you enter the "BCLK Advanced Setting".

Configuration options: [Auto] [Disabled] [Down Spreading 0.10%]  
[[Down Spreading 0.25%] [Down Spreading 0.50%] [Center Spreading 0.10%]  
[Center Spreading 0.25%] [Center Spreading 0.50%]

## BCLK Delay

After raising BCLK, BIOS adds a delay time (ms) for stability. The item appears when you enter the "BCLK Advanced Setting".

## BCLK Aware Adaptive Voltage

Allows you to set BCLK Aware Adaptive Voltage as enabled or disabled. When it is enabled, pcode will be aware of the BCLK frequency when calculating the CPU V/F curves. This is ideal for BCLK OC to avoid high voltage overrides.

Configuration options: [Enabled] [Disabled]

## Boot Performance Mode

Default is Max Non-Turbo performance mode. It will keep cpu Flex-ratio till OS handoff. Max Battery mode will set CPU ratio as x8 till OS handoff. This option is suggested for BCLK overclocking.

Configuration options: [Max Battery] [Max Non-Turbo Performance] [Turbo Performance]

## Ring to Core Ratio Offset

Disable Ring to Core Ratio Offset so the ring and core can run at the same frequency.

Configuration options: [Enabled] [Disabled]

## SA PLL Frequency

Allows you to configure SA PLL Frequency.

Configuration options: [Auto] [3200 MHz] [1600 MHz]

## BCLK TSC HW Fixup

BCLK TSC HW Fixup is disabled during TSC copy from PMA to APIC.

Configuration options: [Enabled] [Disabled]

## FLL Overclock Mode

Allows you to enable or disable FLL Overclock Mode. The default setting is [Disabled].

Configuration options: [Enabled] [Disabled]

## FLL Overclock Mode Select

Allows you to select FLL Mode Value from Range 1 to 3. 0x0 = no overclocking, 0x1 = ratio overclocking with nominal (0.5-1x) reference clock frequency; 0x2 = BCLK overclocking with elevated (1-3x) reference clock frequency; 0x3 = BCLK overclocking with extremely elevated (3-5x) reference clock frequency and ratio limited to 63. This item appears when “FLL Overclock Mode“ is set to [Enabled].

## UnderVolt Protection

When UnderVolt Protection is enabled, user will not be able to program under voltage in OS runtime. It is recommended to keep it enabled by default.

[Enabled] The item allows BIOS undervolting, but enables UnderVolt Protection in Runtime.

[Disabled] No UnderVolt Protection in Runtime.

## Intel SpeedStep Technology

Intel SpeedStep technology allows processors to switch between multiple frequencies and voltage points for better power saving and heat dissipation. CPU turbo ratio can be fixed when Intel SpeedStep Technology is set to Disabled and Intel Turbo Boost Technology is set to Enabled.

Configuration options: [Enabled] [Disabled]

## Intel Turbo Boost Technology

Intel Turbo Boost Technology enables the processor to run above its base operating frequency when the operating system requests the highest performance state.

Configuration options: [Enabled] [Disabled]

## Intel Speed Shift Technology

Allows you to enable or disable the Intel Speed Shift Technology support. Enabling will expose the CPPC v2 interface to allow for hardware controlled P-states. To get the best support for Intel Turbo Boost Max Technology 3.0 (ITBMT 3.0), you have to enable Intel Speed Shift Technology. If your CPU does not support ITBMT 3.0, option will still be grayed out.

Configuration options: [Enabled] [Disabled]

## Intel Turbo Boost Max Technology 3.0

Allows you to enable or disable the Intel Turbo Boost Max Technology 3.0 (ITBMT 3.0) support. Disabling will report the maximum ratio of the slowest core in `_CPC` object. Processors supporting the ITBMT 3.0 feature contain at least one processor core whose maximum ratio is higher than the others.

Configuration options: [Enabled] [Disabled]

## Intel Thermal Velocity Boost Voltage Optimizations

This service controls thermal based voltage optimizations for processors that implement the Intel Thermal Velocity Boost (TVB) feature.

Configuration options: [Enabled] [Disabled]

## Enhanced Thermal Velocity Boost

When this item is enabled, the user will be clipped when the temperatures reaches the default threshold on supported products. Recommended to disable it for overclocking. This item appears depending on the CPU you use on your motherboard.

Configuration options: [Auto] [Enabled] [Disabled]

## TVB Information

Press [Enter] to view TVB information.

## CPU Tj Max

Allows you to set CPU Tj Max to adjust TCC Target Temperature. It supports Tj Max in the range of 62 to 115 deg Celsius.

## Dual Tau Boost

Enable Dual Tau Boost feature for 35W/65W/125W CPU to achieve performance boost with additional PL1 greater than TDP for limited durations.

## Load Intel Base Power Limit Settings

Allows you to enable or disable the Intel Base Power Limit Settings. When it is enabled, the power limit and current limit will use Intel Base Power Limit Settings.

## Long Duration Power Limit

Allows you to configure Package Power Limit 1 in watts. When the limit is exceeded, the CPU ratio will be lowered after a period of time. A lower limit can protect the CPU and save power, while a higher limit may improve performance.

## Long Duration Maintained

Allows you to configure the period of time until the CPU ratio is lowered when the Long Duration Power Limit is exceeded.

## Short Duration Power Limit

Allows you to configure Package Power Limit 2 in watts. When the limit is exceeded, the CPU ratio will be lowered immediately. A lower limit can protect the CPU and save power, while a higher limit may improve performance.

## CPU Core Unlimited Current Limit

To unlock voltage regulator current limit completely, you can set this option to [Enabled].

Configuration options: [Auto] [Enabled] [Disabled]

## CPU Core Current Limit

Voltage Regulator Current Limit. This value represents the Maximum instantaneous current allowed at any given time.

## GT Unlimited Current Limit

To unlock voltage regulator current limit completely, you can set this option to [Enabled]. This item appears when you use the onboard graphics.

## GT Current Limit

Voltage Regulator Current Limit. This value represents the Maximum instantaneous current allowed at any given time. This item appears when you use the onboard graphics.

## DRAM Configuration

### Memory Information

Allows you to browse the serial presence detect (SPD) and Intel extreme memory profile (XMP) for memory modules.

### DRAM Timing Configuration

#### Load XMP Setting

Allows you to load XMP settings to overclock the memory and perform beyond standard specifications.

Configuration options: [Auto] [XMP 3.0 Profile 1]

#### XMP Timing Mode

Allows you to choose the behavior for XMP timing: apply all timing or only first timing.

Configuration options: [Apply All Timing] [Apply Primary Timing] [Run MRC Timing]

## Dynamic Memory Boost

Allows you to enable or disable Dynamic Memory Boost feature. You can automatically switch between the default SPD Profile frequency and the selected XMP profile frequency. Only valid if an XMP Profile is selected.

Configuration options: [Enabled] [Disabled]

## Realtime Memory Frequency

Allows you to enable or disable Realtime Memory Frequency feature. You can manually switch in runtime between the default SPD Profile frequency and the selected XMP profile frequency. Only valid if an XMP Profile is selected.

Configuration options: [Enabled] [Disabled]

## DRAM Reference Clock

Allows you to configure DRAM Reference Clock. Select [Auto] for optimized settings.

Configuration options: [Auto] [100MHz] [133MHz]

## DRAM Frequency

If [Auto] is selected, the motherboard will detect the memory module(s) inserted and assign the appropriate frequency automatically.

## DRAM Gear Mode

Allows you to select the DRAM Gear Mode. High gear is good for high frequency.

Configuration options: [Auto] [Gear 2] [Gear 4]

## BCLK Frequency

The CPU speed is determined by the CPU Ratio multiplied with the BCLK. Increasing the BCLK will increase the internal CPU clock speed but also affect the clock speed of other components.

## Primary Timing

### CAS# Latency (tCL)

The time between sending a column address to the memory and the beginning of the data in response.

### RAS# to CAS# Delay (tRCD)

RAS# to CAS# Delay : The number of clock cycles required between the opening of a row of memory and accessing columns within it.



### Row Precharge (tRP)

The number of clock cycles required between the issuing of the precharge command and opening the next row.

### RAS# Active Time (tRAS)

The number of clock cycles required between a bank active command and issuing the precharge command.

### Command Rate (CR)

The delay between when a memory chip is selected and when the first active command can be issued.

### Secondary Timing

#### Write Recovery Time (tWR)

The amount of delay that must elapse after the completion of a valid write operation, before an active bank can be precharged.

#### Refresh Cycle Time 2 (tRFC2)

The number of clocks from a Refresh command until the first Activate command to the same rank.

#### Refresh Cycle Time per Bank (tRFCpb)

The number of clocks from a Refresh command (per bank) until the first Activate command to the same rank.

#### RAS to RAS Delay (tRRD\_L)

The number of clocks between two rows activated in different banks of the same rank.

#### RAS to RAS Delay (tRRD\_S)

The number of clocks between two rows activated in different banks of the same rank.

#### Write to Read Delay (tWTR\_L)

The number of clocks between the last valid write operation and the next read command to the same internal bank.

#### Write to Read Delay (tWTR\_S)

The number of clocks between the last valid write operation and the next read command to the same internal bank.

## Read to Precharge (tRTP)

The number of clocks that are inserted between a read command to a row pre-charge command to the same rank.

## Four Activate Window (tFAW)

The time window in which four activates are allowed the same rank.

## CAS Write Latency (tCWL)

Configure CAS Write Latency.

## Third Timing

### tREFI

Configure refresh cycles at an average periodic interval.

### tCKE

Configure the period of time the DDR4 initiates a minimum of one refresh command internally once it enters Self-Refresh mode.

### tRC

Configure the minimum active to active/Refresh Time.

## Turn Around Timing

### Turn Around Timing Optimization

Auto is enabled in general case.

Configuration options: [Auto] [Enabled] [Disabled]

## TAT Training Value

### tRDRD\_sg

Configure between module read to read delay.

Configuration options: [Auto] [0] - [127]

### tRDRD\_dg

Configure between module read to read delay.

Configuration options: [Auto] [0] - [127]

### tRDRD\_dr

Configure between module read to read delay.

Configuration options: [Auto] [0] - [255]

**tRDRD\_dd**

Configure between module read to read delay.

Configuration options: [Auto] [0] - [255]

**tRDWR\_sg**

Configure between module read to write delay.

Configuration options: [Auto] [0] - [255]

**tRDWR\_dg**

Configure between module read to write delay.

Configuration options: [Auto] [0] - [255]

**tRDWR\_dr**

Configure between module read to write delay.

Configuration options: [Auto] [0] - [255]

**tRDWR\_dd**

Configure between module read to write delay.

Configuration options: [Auto] [0] - [255]

**tWRRD\_sg**

Configure between module write to read delay.

Configuration options: [Auto] [0] - [511]

**tWRRD\_dg**

Configure between module write to read delay.

Configuration options: [Auto] [0] - [511]

**tWRRD\_dr**

Configure between module write to read delay.

Configuration options: [Auto] [0] - [127]

**tWRRD\_dd**

Configure between module write to read delay.

Configuration options: [Auto] [0] - [127]

### **tWRWR\_sg**

Configure between module write to write delay.

Configuration options: [Auto] [0] - [127]

### **tWRWR\_dg**

Configure between module write to write delay.

Configuration options: [Auto] [0] - [127]

### **tWRWR\_dr**

Configure between module write to write delay.

Configuration options: [Auto] [0] - [127]

### **tWRWR\_dd**

Configure between module write to write delay.

Configuration options: [Auto] [0] - [255]

## **TAT Runtime Value**

### **tRDRD\_sg**

Configure between module write to read delay.

Configuration options: [Auto] [0] - [127]

### **tRDRD\_dg**

Configure between module write to read delay.

Configuration options: [Auto] [0] - [127]

### **tRDRD\_dr**

Configure between module write to read delay.

Configuration options: [Auto] [0] - [255]

### **tRDRD\_dd**

Configure between module write to read delay.

Configuration options: [Auto] [0] - [255]

### **tRDWR\_sg**

Configure between module write to read delay.

Configuration options: [Auto] [0] - [255]

**tRDWR\_dg**

Configure between module write to read delay.

Configuration options: [Auto] [0] - [255]

**tRDWR\_dr**

Configure between module write to read delay.

Configuration options: [Auto] [0] - [255]

**tRDWR\_dd**

Configure between module write to read delay.

Configuration options: [Auto] [0] - [255]

**tWRRD\_sg**

Configure between module write to read delay.

Configuration options: [Auto] [0] - [511]

**tWRRD\_dg**

Configure between module write to read delay.

Configuration options: [Auto] [0] - [511]

**tWRRD\_dr**

Configure between module write to read delay.

Configuration options: [Auto] [0] - [127]

**tWRRD\_dd**

Configure between module write to read delay.

Configuration options: [Auto] [0] - [127]

**tWRWR\_sg**

Configure between module write to write delay.

Configuration options: [Auto] [0] - [127]

**tWRWR\_dg**

Configure between module write to write delay.

Configuration options: [Auto] [0] - [127]

## **tWRWR\_dr**

Configure between module write to write delay.

Configuration options: [Auto] [0] - [127]

## **tWRWR\_dd**

Configure between module write to write delay.

Configuration options: [Auto] [0] - [255]

## **Round Trip Timing**

### **Round Trip Timing Optimization**

Auto is enabled in general case.

Configuration options: [Auto] [Enabled] [Disabled]

### **Round Trip Level**

Configure round trip level.

Configuration options: [Tightest] [Tighter] [Tight] [Normal] [Loose] [Looser] [Loosest]

### **Initial RTL IO Delay Offset**

Configure round trip latency IO delay initial offset.

### **Initial RTL FIFO Delay Offset**

Configure round trip latency FIFO delay initial offset.

### **Initial RTL (MC0 C0 A1/A2)**

Configure round trip latency initial value.

### **Initial RTL (MC0 C1 A1/A2)**

Configure round trip latency initial value.

### **Initial RTL (MC1 C0 B1/B2)**

Configure round trip latency initial value.

### **Initial RTL (MC1 C1 B1/B2)**

Configure round trip latency initial value.

### **RTL (MC0 C0 A1/A2)**

Configure round trip latency.

**RTL (MC0 C1 A1/A2)**

Configure round trip latency.

**RTL (MC1 C0 B1/B2)**

Configure round trip latency.

**RTL (MC1 C1 B1/B2)**

Configure round trip latency.

**ODT Setting****Dimm ODT Training**

Dimm On-Die Termination Training. ODT values will be optimized by this training.

Configuration options: [Auto] [Enabled] [Disabled]

**ODT WR (A1)**

Configure the memory on die termination resistors' WR.

Configuration options: [Auto] [34] [40] [48] [60] [80] [120] [240] [Disabled]

**ODT WR (A2)**

Configure the memory on die termination resistors' WR.

Configuration options: [Auto] [34] [40] [48] [60] [80] [120] [240] [Disabled]

**ODT WR (B1)**

Configure the memory on die termination resistors' WR.

Configuration options: [Auto] [34] [40] [48] [60] [80] [120] [240] [Disabled]

**ODT WR (B2)**

Configure the memory on die termination resistors' WR.

Configuration options: [Auto] [34] [40] [48] [60] [80] [120] [240] [Disabled]

**ODT NOM Rd (A1)**

Configure the memory on die termination resistors' NOM Rd.

Configuration options: [Auto] [34] [40] [48] [60] [80] [120] [240] [Disabled]

**ODT NOM Rd (A2)**

Configure the memory on die termination resistors' NOM Rd.

Configuration options: [Auto] [34] [40] [48] [60] [80] [120] [240] [Disabled]

### ODT NOM Rd (B1)

Configure the memory on die termination resistors' NOM Rd.

Configuration options: [Auto] [34] [40] [48] [60] [80] [120] [240] [Disabled]

### ODT NOM Rd (B2)

Configure the memory on die termination resistors' NOM Rd.

Configuration options: [Auto] [34] [40] [48] [60] [80] [120] [240] [Disabled]

### ODT NOM Wr (A1)

Configure the memory on die termination resistors' NOM Wr.

Configuration options: [Auto] [34] [40] [48] [60] [80] [120] [240] [Disabled]

### ODT NOM Wr (A2)

Configure the memory on die termination resistors' NOM Wr.

Configuration options: [Auto] [34] [40] [48] [60] [80] [120] [240] [Disabled]

### ODT NOM Wr (B1)

Configure the memory on die termination resistors' NOM Wr.

Configuration options: [Auto] [34] [40] [48] [60] [80] [120] [240] [Disabled]

### ODT NOM Wr (B2)

Configure the memory on die termination resistors' NOM Wr.

Configuration options: [Auto] [34] [40] [48] [60] [80] [120] [240] [Disabled]

### ODT PARK (A1)

Configure the memory on die termination resistors' PARK.

Configuration options: [Auto] [34] [40] [48] [60] [80] [120] [240] [Disabled]

### ODT PARK (A2)

Configure the memory on die termination resistors' PARK.

Configuration options: [Auto] [34] [40] [48] [60] [80] [120] [240] [Disabled]

### ODT PARK (B1)

Configure the memory on die termination resistors' PARK.

Configuration options: [Auto] [34] [40] [48] [60] [80] [120] [240] [Disabled]



**ODT PARK (B2)**

Configure the memory on die termination resistors' PARK.

Configuration options: [Auto] [34] [40] [48] [60] [80] [120] [240] [Disabled]

**ODT PARK DQS (A1)**

Configure the memory on die termination resistors' PARK DQS.

Configuration options: [Auto] [34] [40] [48] [60] [80] [120] [240] [Disabled]

**ODT PARK DQS (A2)**

Configure the memory on die termination resistors' PARK DQS.

Configuration options: [Auto] [34] [40] [48] [60] [80] [120] [240] [Disabled]

**ODT PARK DQS (B1)**

Configure the memory on die termination resistors' PARK DQS.

Configuration options: [Auto] [34] [40] [48] [60] [80] [120] [240] [Disabled]

**ODT PARK DQS (B2)**

Configure the memory on die termination resistors' PARK DQS.

Configuration options: [Auto] [34] [40] [48] [60] [80] [120] [240] [Disabled]

**ODT CA (A1 Group A)**

Configure the memory on die termination resistors' CA.

Configuration options: [Auto] [40] [60] [80] [120] [240] [480] [Disabled]

**ODT CA (A2 Group A)**

Configure the memory on die termination resistors' CA.

Configuration options: [Auto] [40] [60] [80] [120] [240] [480] [Disabled]

**ODT CA (B1 Group A)**

Configure the memory on die termination resistors' CA.

Configuration options: [Auto] [40] [60] [80] [120] [240] [480] [Disabled]

**ODT CA (B2 Group A)**

Configure the memory on die termination resistors' CA.

Configuration options: [Auto] [40] [60] [80] [120] [240] [480] [Disabled]

### **ODT CA (A1 Group B)**

Configure the memory on die termination resistors' CA.

Configuration options: [Auto] [40] [60] [80] [120] [240] [480] [Disabled]

### **ODT CA (A2 Group B)**

Configure the memory on die termination resistors' CA.

Configuration options: [Auto] [40] [60] [80] [120] [240] [480] [Disabled]

### **ODT CA (B1 Group B)**

Configure the memory on die termination resistors' CA.

Configuration options: [Auto] [40] [60] [80] [120] [240] [480] [Disabled]

### **ODT CA (B2 Group B)**

Configure the memory on die termination resistors' CA.

Configuration options: [Auto] [40] [60] [80] [120] [240] [480] [Disabled]

### **ODT CS (A1 Group A)**

Configure the memory on die termination resistors' CS.

Configuration options: [Auto] [40] [60] [80] [120] [240] [480] [Disabled]

### **ODT CS (A2 Group A)**

Configure the memory on die termination resistors' CS.

Configuration options: [Auto] [40] [60] [80] [120] [240] [480] [Disabled]

### **ODT CS (B1 Group A)**

Configure the memory on die termination resistors' CS.

Configuration options: [Auto] [40] [60] [80] [120] [240] [480] [Disabled]

### **ODT CS (B2 Group A)**

Configure the memory on die termination resistors' CS.

Configuration options: [Auto] [40] [60] [80] [120] [240] [480] [Disabled]

### **ODT CS (A1 Group B)**

Configure the memory on die termination resistors' CS.

Configuration options: [Auto] [40] [60] [80] [120] [240] [480] [Disabled]

**ODT CS (A2 Group B)**

Configure the memory on die termination resistors' CS.

Configuration options: [Auto] [40] [60] [80] [120] [240] [480] [Disabled]

**ODT CS (B1 Group B)**

Configure the memory on die termination resistors' CS.

Configuration options: [Auto] [40] [60] [80] [120] [240] [480] [Disabled]

**ODT CS (B2 Group B)**

Configure the memory on die termination resistors' CS.

Configuration options: [Auto] [40] [60] [80] [120] [240] [480] [Disabled]

**ODT CK (A1 Group A)**

Configure the memory on die termination resistors' CK.

Configuration options: [Auto] [40] [60] [80] [120] [240] [480] [Disabled]

**ODT CK (A2 Group A)**

Configure the memory on die termination resistors' CK.

Configuration options: [Auto] [40] [60] [80] [120] [240] [480] [Disabled]

**ODT CK (B1 Group A)**

Configure the memory on die termination resistors' CK.

Configuration options: [Auto] [40] [60] [80] [120] [240] [480] [Disabled]

**ODT CK (B2 Group A)**

Configure the memory on die termination resistors' CK.

Configuration options: [Auto] [40] [60] [80] [120] [240] [480] [Disabled]

**ODT CK (A1 Group B)**

Configure the memory on die termination resistors' CK.

Configuration options: [Auto] [40] [60] [80] [120] [240] [480] [Disabled]

**ODT CK (A2 Group B)**

Configure the memory on die termination resistors' CK.

Configuration options: [Auto] [40] [60] [80] [120] [240] [480] [Disabled]

## ODT CK (B1 Group B)

Configure the memory on die termination resistors' CK.

Configuration options: [Auto] [40] [60] [80] [120] [240] [480] [Disabled]

## ODT CK (B2 Group B)

Configure the memory on die termination resistors' CK.

Configuration options: [Auto] [40] [60] [80] [120] [240] [480] [Disabled]

## Advanced Setting

### ASRock Timing Optimization

Enable/Disable ASRock Timing Optimization. When enabled, the memory timing will use ASRock optimized value.

Configuration options: [Enabled] [Disabled]

### ASRock DRAM Frequency Optimization

Enable/Disable ASRock DRAM Frequency Optimization. When enabled, the DRAM Frequency will run ASRock optimized procedure.

Configuration options: [Auto] [Enabled] [Disabled]

### MRC Training Respond Time

Configure the MRC Training Respond Time.

Configuration options: [Auto] [Slowest]

### Realtime Memory Timing

Enable/Disable realtime memory timings. When enabled, the system will allow performing realtime memory changes after MRC\_DONE.

Configuration options: [Enabled] [Disabled]

### Reset for MRC Failed

Reset system after MRC training is failed.

Configuration options: [Enabled] [Disabled]

### MRC Training on Warm Boot

When enabled, memory training will be executed when warm boot.

Configuration options: [Auto] [Enabled] [Disabled]

## MRC Fast Boot

When enabled, portions of memory reference code will be skipped when possible to increase boot speed.

Configuration options: [Auto] [Enabled] [Disabled]

## Voltage Configuration

### Voltage Mode

[OC Mode]: Larger range voltage for overclocking.

[Stable Mode]: Smaller range voltage for stable system.

### CPU CORE/Cache Voltage

Input voltage for the processor by the external voltage regulator.

Configuration options: [Auto] [Offset Mode] [Fixed Mode]

### Fixed Voltage(V)

Overvoltage may damage the system or reduce its life cycle.

The item appears when "CPU CORE/Cache Voltage" is set to [Fixed Mode].

### CPU CORE/Cache Load-Line Calibration

Load-Line is defined by Intel VRM Spec and affects the CPU power voltage. CPU Load-Line Calibration helps prevent CPU voltage droop when the system is under heavy loading. Higher load-line (Level 1) calibration gets higher voltage and good overclocking performance but increases the CPU and VRM thermal.

Configuration options: [Auto] [Level 1] [Level 2] [Level 3] [Level 4] [Level 5]

\*[Level 1] and [Level 2] options appear depending on the CPU you use on your motherboard.

### CPU GT Voltage

Allows you to input voltage for the processor by the external voltage regulator.

Configuration options: [Auto] [Offset Mode] [Fixed Mode]

### CPU GT Load-Line Calibration

CPU GT Load-Line Calibration helps prevent GT voltage droop when the system is under heavy load.

Configuration options: [Auto] [Level 1] [Level 2] [Level 3] [Level 4] [Level 5]

\*[Level 1] and [Level 2] options appear depending on the CPU you use on your motherboard.

## DRAM Voltage

Allows you to configure the DRAM Voltage for CPU I/O to memory.

## VDD\_CPU Voltage

Allows you to configure the VDD\_CPU Voltage for CPU I/O to memory.

## VDD\_IMC Voltage

Allows you to configure the VDD\_IMC Voltage for CPU memory controller.

## +1.8V PROC Voltage

Allows you to configure the voltage for the +1.8V PROC.

## +1.05V PROC Voltage

Allows you to configure the voltage for the +1.05V PROC.

## VCCIN AUX Voltage

Allows you to configure the voltage for the VCCIN AUX.

## +0.82V PCH Voltage

Allows you to configure the voltage for the +0.82V PCH.

## +1.05 PCH Voltage

Allows you to configure the voltage for the +1.05 PCH.

## DDR5 PMIC Configuration

### PMIC Voltage Option

[United] Allows you to adjust DIMM PMIC altogether.

[Separate] Allows you to individually adjust DIMM PMIC.

## VDD Voltage

Allows you to configure the VDD Voltage supported by PMIC at DRAM side. The VDD output can be measured through PMIC ADC with step size 0.015V. VDD information is contained in memory SPD and XMP, you can check it via Memory Information tool.

## VDD Voltage Range

JEDEC Standard ranges from 0.800V to 1.435V. OC Demand ranges from 0.800V to 2.070V. OC Demand may not be applied if PMIC OC CAP is JEDEC PMIC. You can check it via the Memory Information tool.

Configuration options: [JEDEC Standard] [OC Demand]

## VDDQ Voltage

Allows you to configure the VDDQ Voltage supported by PMIC at DRAM side. The VDDQ output can be measured through PMIC ADC with step size 0.015V. VDDQ information is contained in memory SPD and XMP. You can check it via the Memory Information tool.

Configuration options: [JEDEC Standard] [OC Demand]

## VDDQ Voltage Range

JEDEC Standard ranges from 0.800V to 1.435V. OC Demand ranges from 0.800V to 2.070V. OC Demand may not be applied if PMIC OC CAP is JEDEC PMIC. You can check it via the Memory Information tool.

Configuration options: [JEDEC Standard] [OC Demand]

## VPP Voltage

Allows you to configure the VPP Voltage supported by PMIC at DRAM side. The VPP output can be measured through PMIC ADC with step size 0.015V. VPP information is contained in memory SPD and XMP. You can check it via the Memory Information tool.

## VDD Eventual Voltage

Allows you to configure the final VDD Voltage.

## VDDQ Eventual Voltage

Allows you to configure the final VDDQ Voltage.

## VPP Eventual Voltage

Allows you to configure the final VPP Voltage.

## PMIC Protection Unlock

Allows you to configure PMIC Protection Unlock settings.

Configuration options: [Auto] [Enabled]

## PLL Voltage Configuration

### P-Core PLL Voltage Offset

PLL Voltage Offset value ranges from 0 to 15 bins, and each bin is 15mV. Adding 5 or more bins will help to increase the range of this domain frequency in extreme overclocking conditions. The best bins will be different on each processor. You have to find the best bins for your own processor.

### E-Core PLL Voltage Offset

PLL Voltage Offset value ranges from 0 to 15 bins, and each bin is 15mV. Adding 5 or more

---

bins will help to increase the range of this domain frequency in extreme overclocking conditions. The best bins will be different on each processor. You have to find the best bins for your own processor.

### Ring PLL Voltage Offset

PLL Voltage Offset value ranges from 0 to 15 bins, and each bin is 15mV. Adding 5 or more bins will help to increase the range of this domain frequency in extreme overclocking conditions. The best bins will be different on each processor. You have to find the best bins for your own processor.

### System Agent PLL Voltage Offset

PLL Voltage Offset value ranges from 0 to 15 bins, and each bin is 15mV. Adding 5 or more bins will help to increase the range of this domain frequency in extreme overclocking conditions. The best bins will be different on each processor. You have to find the best bins for your own processor.

### Memory Controller PLL Voltage Offset

PLL Voltage Offset value ranges from 0 to 15 bins, and each bin is 15mV. Adding 5 or more bins will help to increase the range of this domain frequency in extreme overclocking conditions. The best bins will be different on each processor. You have to find the best bins for your own processor.

### GT PLL Voltage Offset

PLL Voltage Offset value ranges from 0 to 15 bins, and each bin is 15mV. Adding 5 or more bins will help to increase the range of this domain frequency in extreme overclocking conditions. The best bins will be different on each processor. You have to find the best bins for your own processor.

## AVX Configuration

### AVX2 Voltage Guardband Scale Factor

AVX2 Voltage Guardband Scale Factor controls the voltage guardband applied to AVX2 workloads. A value > 1.00 will increase the voltage guardband, and < 1.00 will decrease the voltage guardband.

## FIVR Configuration

### Core Voltage Mode

Selects between Adaptive and Override Voltage modes. In Override Mode, the voltage selected will be applied overall operating frequencies. In Adaptive mode, the voltage is interpolated only in turbo mode.

Configuration options: [Adaptive] [Override]



## Extra Turbo Voltage

Specifies the extra turbo voltage applied while the Core is operating in turbo mode.

## VF Offset Mode

Selects between Legacy and Selection modes. Need Reset System after enabling OverClocking Feature to Initialize the default value. In Legacy Mode, setting a global offset for the entire VF curve. In Selection modes, setting a selected VF point.

Configuration options: [Legacy] [Selection]

## VF Configuration Scope

Allows you to configure the VF-curve per core or all cores.

Configuration options: [All-core] [Per-core]

## Core Voltage Offset

Specifies the Offset Voltage applied to the Global Core domain. This voltage is specified in millivolts.

## E-Core L2 Voltage Mode

Selects between adaptive and Override Voltage modes. In Override Mode the voltage selected will be applied overall operating frequencies. In Adaptive Mode the voltage is interpolated only in turbo mode.

Configuration options: [Adaptive] [Override]

## Extra Turbo Voltage

Specifies the extra turbo voltage applied while the Core is operating in turbo mode.

## E-Core L2 Voltage Offset

Specifies the Offset Voltage applied to the E-Core L2 domain. This voltage is specified in millivolts.

## Ring Voltage Mode

Selects between adaptive and Override Voltage modes. In Override Mode the voltage selected will be applied overall operating frequencies. In Adaptive Mode the voltage is interpolated only in turbo mode.

Configuration options: [Adaptive] [Override]

## Extra Turbo Voltage

Specifies the extra turbo voltage applied while ring is operating in turbo mode.

## VF Offset Mode

Selects between Legacy and Selection modes. Need Reset System after enabling Over-Clocking Feature to Initialize the default value. In Legacy Mode, setting a global offset for the entire VF curve. In Selection modes, setting a selected VF point.

Configuration options: [Legacy] [Selection]

## Ring Voltage Offset

Specifies the Offset Voltage applied to the Ring domain. This voltage is specified in millivolts.

## GT Voltage Mode

Selects between adaptive and Override Voltage modes. In Override Mode the voltage selected will be applied overall operating frequencies. In Adaptive Mode the voltage is interpolated only in turbo mode. This item appears when you use the onboard graphics.

Configuration options: [Adaptive] [Override]

## Extra Turbo Voltage

Specifies the extra turbo voltage applied while the GT is operating in turbo mode. Unit is in millivolts.

## GT Voltage Offset

Specifies the Offset Voltage applied to the GT domain. This voltage is specified in millivolts. This item appears when you use the onboard graphics.

## System Agent Voltage Mode

Selects between Adaptive and Override Voltage modes. In Override Mode the voltage selected will be applied overall operating frequencies. In Adaptive Mode the voltage is interpolated only in turbo mode.

Configuration options: [Adaptive] [Override]

## Extra Turbo Voltage

Specifies the extra turbo voltage applied while the SA Uncore is operating in turbo mode. Unit is in millivolts.

## System Agent Voltage Offset

Specifies the Offset Voltage applied to the Uncore domain. This voltage is specified in millivolts.

### Save User Default

Type a profile name and press enter to save your settings as user default.

### Load User Default

Load previously saved user defaults.

### Save User UEFI Setup Profile to Disk

It helps you to save current UEFI settings as an user profile to disk.

### Load User UEFI Setup Profile from Disk

You can load previous saved profile from the disk.

## 3.4 Advanced Screen

In this section, you may set the configurations for the following items: CPU Configuration, Chipset Configuration, Storage Configuration, Intel(R) Thunderbolt, Super IO Configuration, ACPI Configuration, USB Configuration and Trusted Computing.



*Setting wrong values in this section may cause the system to malfunction.*

### UEFI Setup Style

Allows you to select the default mode when entering the UEFI setup utility.

Configuration options: [Easy Mode] [Advanced Mode]

### Active Page on Entry

Allows you to select the default page when entering the UEFI setup utility.

Configuration options: [My Favorite] [Main] [OC Tweaker] [Advanced] [Tool] [H/W Monitor] [Security] [Boot] [Exit]

### Full HD UEFI

[Auto]

When [Auto] is selected, the resolution will be set to 1920 x 1080 if the monitor supports Full HD resolution. If the monitor does not support Full HD resolution, then the resolution will be set to 1024 x 768.

[Disabled]

When [Disabled] is selected, the resolution will be set to 1024 x 768 directly.

## 3.4.1 CPU Configuration



### Processor P-Core Information

Press [Enter] to view P-Core Information.

### Processor E-Core Information

Press [Enter] to view E-Core Information.

### Intel Hyper Threading Technology

Intel Hyper Threading Technology allows multiple threads to run on each core, so that the overall performance on threaded software is improved.

Configuration options: [Enabled] [Disabled]

### Per-Core Hyper Threading

Press [Enter] to configure Per-Core Hyper Threading. This allows you to disable Hyper Threading on specific cores.

### Active Processor P-Cores

Allows you to select the number of cores to enable in each processor package.

### Active Processor E-Cores

Allows you to select the number of E-Cores to enable in each processor package. Note: Number of P-Cores and E-Cores are looked at together. When both are {0,0}, Pcode will enable all cores.

## CPU C States Support

Allows you to enable CPU C States Support for power saving. It is recommended to keep C3, C6 and C7 all enabled for better power saving.

Configuration options: [Enabled] [Disabled]

## Enhanced Halt State (C1E)

Allows you to enable Enhanced Halt State (C1E) for lower power consumption.

Configuration options: [Auto] [Enabled] [Disabled]

## CPU C6 State Support

Allows you to enable C6 deep sleep state for lower power consumption.

Configuration options: [Auto] [Enabled] [Disabled]

## CPU C7 State Support

Allows you to enable C7 deep sleep state for lower power consumption.

Configuration options: [Auto] [Enabled] [Disabled]

## Package C State Support

Allows you to enable CPU, PCIe, Memory, Graphics C State Support for power saving.

Configuration options: [Auto] [Enabled] [Disabled]

## CFG Lock

Allows you to enable or disable the CFG Lock.

Configuration options: [Enabled] [Disabled]

## C6DRAM

Allows you to enable or disable moving of DRAM contents to PRM memory when CPU is in C6 state.

Configuration options: [Enabled] [Disabled]

## CPU Thermal Throttling

Allows you to enable CPU internal thermal control mechanisms to keep the CPU from overheating.

Configuration options: [Enabled] [Disabled]

---

## Intel AVX/AVX2

Allows you to enable or disable the Intel AVX and AVX2 Instructions. This is applicable for Big Core only.

Configuration options: [Enabled] [Disabled]

## Intel ATX-512

Allows you to enable or disable the Intel AVX-512 (a.k.a. AVX3) Instructions. This is applicable for Big Core only.

## Intel Virtualization Technology

Intel Virtualization Technology allows a platform to run multiple operating systems and applications in independent partitions, so that one computer system can function as multiple virtual systems.

Configuration options: [Enabled] [Disabled]

## Hardware Prefetcher

Allows you to enable or disable Hardware Prefetcher that automatically prefetches data and code for the processor. Enable this item for better performance.

Configuration options: [Enabled] [Disabled]

## Adjacent Cache Line Prefetch

Allows you to enable or disable Adjacent Cache Line Prefetch that automatically prefetches the subsequent cache line while retrieving the currently requested cache line. Enable this item for better performance.

Configuration options: [Enabled] [Disabled]

## Legacy Game Compatibility Mode

When enabled, pressing the scroll lock key will toggle the Efficient cores between being parked when Scroll Lock LED is on and un-parked when LED is off.

Configuration options: [Enabled] [Disabled]



## 3.4.2 Chipset Configuration



### Primary Graphics Adapter

Allows you to select a primary VGA.

Configuration options: [Auto] [Onboard] [PCI E1] (Options vary when you've installed a graphics card on your motherboard.)

### Above 4G Decoding

Allows you to enable or disable above 4G MemoryMappedIO decoding. This is disabled automatically when Aperture Size is set to 2048MB.

Configuration options: [Enabled] [Disabled]

### C.A.M (Clever Access Memory)

If system has Resizable BAR capable PCIe Devices, use this option to enable or disable Resizable BAR support (only of the system supports 64-bit PCI decoding).

Configuration options: [Enabled] [Disabled]

### VT-d

Intel® Virtualization Technology for Directed I/O helps your virtual machine monitor better utilize hardware by improving application compatibility and reliability, and providing additional levels of manageability, security, isolation, and I/O performance.

Configuration options: [Enabled] [Disabled]

## SR-IOV Support

If system has SR-IOV capable PCIe Devices, this option Enables or Disables Single Root IO Virtualization Support.

Configuration options: [Enabled] [Disabled]

## DMI Link Speed

Allows you to configure DMI Slot Link Speed.

Configuration options: [Gen1] [Gen2] [Gen3] [Gen4]

## PCIe1 Link Speed

Allows you to configure PCIe1 Slot Link Speed. Auto mode is optimizing for overclocking.

Configuration options: [Auto] [Gen1] [Gen2] [Gen3] [Gen4] [Gen5] (Options vary depending on your motherboard.)

## PCIe2 Link Speed

Allows you to configure PCIe2 Slot Link Speed. Auto mode is optimizing for overclocking.

Configuration options: [Auto] [Gen1] [Gen2] [Gen3] [Gen4] [Gen5] (Options vary depending on your motherboard.)

## PCIe3 Link Speed

Allows you to configure PCIe3 Slot Link Speed. Auto mode is optimizing for overclocking.

Configuration options: [Auto] [Gen1] [Gen2] [Gen3] [Gen4] (Options vary depending on your motherboard.)

## PCI Express Native Control

Select Enabled for enhanced PCI Express power saving in OS.

Configuration options: [Enabled] [Disabled]

## PCIe ASPM Support

This option controls the ASPM support for all CPU downstream devices.

Configuration options: [Disabled] [L0s] [L1] [L0sL1]

## PCH PCIe ASPM Support

This option controls the ASPM support for all PCH downstream devices.

Configuration options: [Disabled] [L1] [Auto]

## DMI ASPM Support

Allows you to configure the PCH DMI ASPM Setting.

Configuration options: [Enabled] [Disabled]

## PCH DMI ASPM Support

Allows you to enable or disable the ASPM support for all PCH DMI devices.

Configuration options: [Enabled] [Disabled]

## Share Memory

Allows you to configure the size of memory that is allocated to the integrated graphics processor when the system boots up.

Configuration options: [Auto] [32M] [64M] [128M] [256M] [512M] [1024M]

Options vary depending on the memory you use on your motherboard.

## IGPU Multi-Monitor

Select [Disabled] to disable the integrated graphics when an external graphics card is installed. Select [Enabled] to keep the integrated graphics enabled at all times.

Configuration options: [Auto] [Enabled] [Disabled]

## Realtek RTL8125BG

Allows you to enable or disable Onboard LAN.

Configuration options: [Enabled] [Disabled]

## Intel(R) Ethernet Connection I219-V

Allows you to enable or disable Onboard LAN.

Configuration options: [Enabled] [Disabled]

## Intel(R) Ethernet Connection I226-V

Allows you to enable or disable Onboard LAN.

Configuration options: [Enabled] [Disabled]

## Killer E3100G

Allows you to enable or disable Onboard LAN.

Configuration options: [Enabled] [Disabled]

## Onboard HD Audio

Allows you to enable or disable the onboard HD audio controller. Set this item to [Auto] to

---

enable the onboard HD and automatically disable it when a sound card is installed.

Configuration options: [Auto] [Enabled] [Disabled]

## Front Panel

Allows you to select Front Panel type.

[HD] sets the front panel audio connector mode to high definition audio.

[AC 97] sets the front panel audio connector mode to legacy AC'97.

## Onboard HDMI HD Audio

Allows you to enable or disable audio for the onboard digital outputs.

This item appears when you've installed a graphics card on your motherboard.

Configuration options: [Enabled] [Disabled].

## Onboard WAN Device

Allows you to enable or disable the onboard WAN device.

Configuration options: [Enabled] [Disabled].

## Deep Sleep

Allows you to configure deep sleep mode for power saving when the computer is shut down. We recommend disabling Deep Sleep for better system compatibility and stability.

Configuration options: [Enabled] [Enabled in S5] [Enabled in S4-S5]

## Restore on AC/Power Loss

Allows you to select the power state after a power failure.

[Power Off] sets the power to remain off when the power recovers.

[Power On] sets the system to start to boot up when the power recovers.

## Turn On Onboard LED in S5

Allows you to turn on or off the Onboard LED in the ACPI S5 state.

Configuration options: [Enabled] [Disabled]

## Restore Onboard LED Default

Allows you to restore Onboard LED default value.

Configuration options: [Disabled] [Apply]

## RGB LED

Allows you to enable or disable the RGB LED.

Configuration options: [On] [Off]

## Onboard Button LED

Allows you to control onboard Power button and Reset button LED.

Configuration options: [On] [Off]

## Onboard Debug Port LED

Allows you to control onboard Dr. Debug LED.

Configuration options: [On] [Off]

## GNA Device

Allows you to enable or disable the SA GNA Device.

Configuration options: [Enabled] [Disabled]

### 3.4.3 Storage Configuration

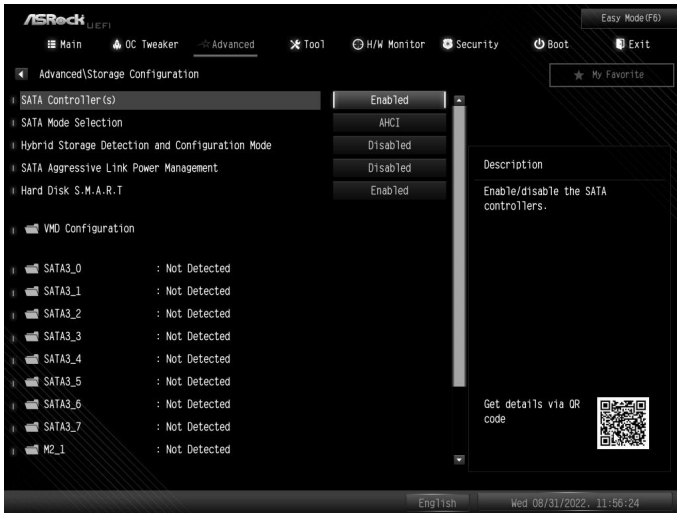

#### SATA Controller(s)

Allows you to enable or disable the SATA controllers.

Configuration options: [Enabled] [Disabled]

#### SATA Mode Selection

AHCI: Supports new features that improve performance.

Configuration option: [AHCI]

#### Hybrid Storage Detection and Configuration Mode

Allows you to select Hybrid Storage Detection and Configuration Mode.

Configuration options: [Dynamic Configuration for Hybrid Storage Enable] [Disabled]

#### SATA Aggressive Link Power Management

SATA Aggressive Link Power Management allows SATA devices to enter a low power state during periods of inactivity to save power. It is only supported by AHCI mode.

Configuration options: [Enabled] [Disabled]

#### Hard Disk S.M.A.R.T.

S.M.A.R.T stands for Self-Monitoring, Analysis, and Reporting Technology. It is a

monitoring system for computer hard disk drives to detect and report on various indicators of reliability.

Configuration options: [Enabled] [Disabled]

## VMD Configuration

Press [Enter] to view the followings items for VMD configurations.

### Enable VMD Controller

Allows you to enable or disable the Intel VMD controller.

This following items appear when it is set to [Enabled].

Configuration options: [Enabled] [Disabled]

### Enable VMD Global Mapping

Allows you to enable or disable the VMD Global Mapping.

Configuration options: [Enabled] [Disabled]

### Map this Root Port under VMD

Allows you to map or unmap this Root Port to VMD. This item is allowed to be configured when "Enable VMD Global Mapping" is set to [Disabled].

Configuration options: [Enabled] [Disabled]

### Root Port BDF details

Displays the Root Port BDF details.

## 3.4.4 Intel(R) Thunderbolt



### Discrete Thunderbolt(TM) Support

Allows you to enable or disable the Discrete Thunderbolt(TM) Support.

Configuration options: [Enabled] [Disabled]

### Thunderbolt Boot Support

The item appears when "Discrete Thunderbolt(TM) Support" is enabled.

[Enabled] sets to boot from Bootable devices which are present behind Thunderbolt.

[Disabled] sets to disallow booting from Bootable devices which are present behind Thunderbolt.

### Thunderbolt Usb Support

The item appears when "Discrete Thunderbolt(TM) Support" is enabled.

[Enabled] sets to boot from Usb devices which are present behind Thunderbolt.

[Disabled] sets to disallow booting from Usb devices which are present behind Thunderbolt.



## Windows 10 Thunderbolt support

The item appears when "Discrete Thunderbolt(TM) Support" is enabled.

Use this item to enable or disable the Windows 10 Thunderbolt support.

Configuration options: [Enabled + RTD3] [Disabled]

## 3.4.5 Super IO Configuration

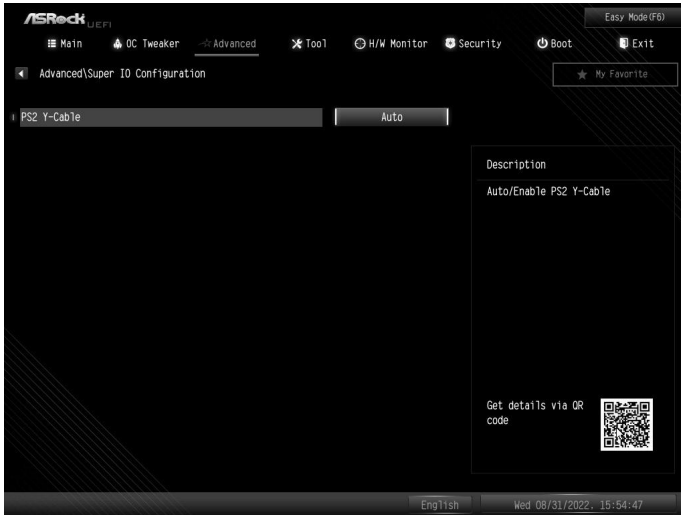

### PS2 Y-Cable

Enable the PS2 Y-Cable or set this option to Auto.

Configuration options: [Auto] [Enabled]

## 3.4.6 ACPI Configuration

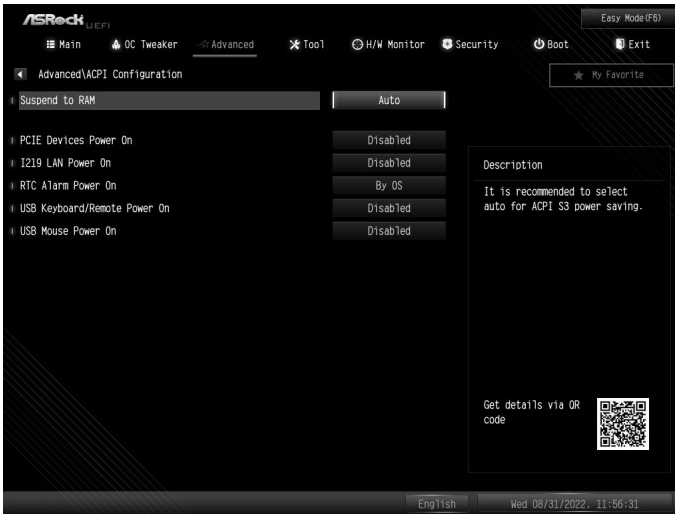

### Suspend to RAM

Allows you to select [Disabled] for ACPI suspend type S1. It is recommended to select [Auto] for ACPI S3 power saving.

Configuration options: [Auto] [Disabled]

### PS/2 Keyboard S4/S5 Wakeup Support

Allows the system to be waked up by a PS/2 Keyboard in S4/S5. This item appears only for the motherboard that supports the PS/2 port.

### PCIE Devices Power On

Allows the system to be waked up by a PCIE device and enable wake on LAN.

Configuration options: [Enabled] [Disabled]

### I219 LAN Power On

Allows the system to be waked up by the Onboard Intel LAN. Item name varies depending on the LAN type of your motherboard.

Configuration options: [Enabled] [Disabled]

### RTC Alarm Power On

Allows the system to be waked up by the real time clock alarm. Set it to By OS to let it be

---

handled by your operating system.

Configuration options: [Enabled] [Disabled] [By OS]

### **USB Keyboard/Remote Power On**

Allows the system to be waked up by an USB keyboard or remote controller.

Configuration options: [Enabled] [Disabled]

### **USB Mouse Power On**

Allows the system to be waked up by an USB mouse.

Configuration options: [Enabled] [Disabled]

## 3.4.7 USB Configuration

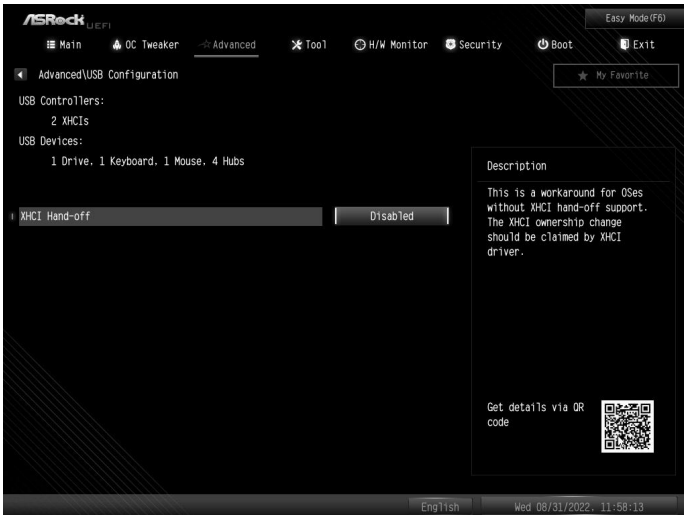

### Legacy USB Support

Allows you to enable or disable Legacy OS Support for USB devices. This item appears only for the motherboard that supports the PS/2 port.

[Auto] disables legacy support if no USB devices are connected.

[Disabled] keeps USB devices available only for EFI applications.

[UEFI Setup Only] sets to support USB devices under the UEFI setup and Windows/Linux operating systems only.

### XHCI Hand-off

This is a workaround for OSes without XHCI hand-off support. The XHCI ownership change should be claimed by XHCI driver.

Configuration options: [Enabled] [Disabled]

## 3.4.8 Trusted Computing



NOTE: Options vary depending on the version of your connected TPM module.

### Security Device Support

Allows you to enable or disable BIOS support for security device. O.S. will not show Security Device. TCG EFI protocol and INT1A interface will not be available.

Configuration options: [Enabled] [Disabled]

### Active PCR banks

This item displays active PCR Banks.

### Available PCR Banks

This item displays available PCR Banks.

### SHA256 PCR Bank

Allows you to enable or disable SHA256 PCR Bank.

Configuration options: [Enabled] [Disabled]

### SHA384 PCR Bank

Allows you to enable or disable SHA384 PCR Bank.

Configuration options: [Enabled] [Disabled]

### SM3\_256 PCR Bank

Allows you to enable or disable SM3\_256 PCR Bank.

Configuration options: [Enabled] [Disabled]

### Pending Operation

Allows you to schedule an Operation for the Security Device.

NOTE: Your computer will reboot during restart in order to change State of the Device.

Configuration options: [None] [TPM Clear]

### Platform Hierarchy

Allows you to enable or disable Platform Hierarchy.

Configuration options: [Enabled] [Disabled]

### Storage Hierarchy

Allows you to enable or disable Storage Hierarchy.

Configuration options: [Enabled] [Disabled]

### Endorsement Hierarchy

Allows you to enable or disable Endorsement Hierarchy.

Configuration options: [Enabled] [Disabled]

### Physical Presence Spec Version

Select this item to tell OS to support PPI spec version 1.2 or 1.3. Please note that some HCK tests might not support version 1.3.

Configuration options: [1.2] [1.3]

### TPM 2.0 InterfaceType

Allows you to view the Communication Interface to TPM 2.0 Device: CRB or ITS.

### Device Select

Allows you to select the TPM device to be supported.

[TPM 1.2] restricts support to TPM 1.2 devices.

[TPM 2.0] restricts support to TPM 2.0 devices.

[Auto] supports both TPM 1.2 and TPM 2.0 devices with the default set to TPM 2.0 devices. If TPM 2.0 devices are not found, TPM 1.2 devices will be enumerated.

## 3.5 Tools

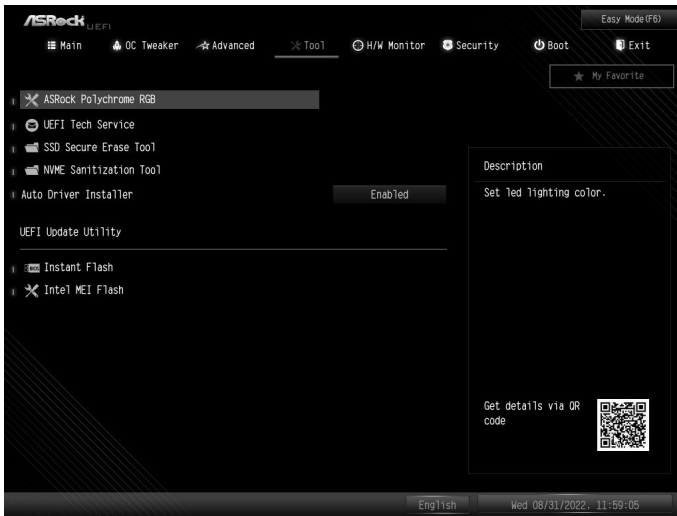

### ASRock Polychrome RGB

Allows you to select LED lighting color.

### UEFI Tech Service

Contact ASRock Tech Service if you are having trouble with your PC. Please setup network configuration before using UEFI Tech Service.

### SSD Secure Erase Tool

Use this tool to securely erase SSD. This tool only lists the SSDs that support the Secure Erase function.

### NVME Sanitization Tool

After you Sanitize SSD, all user data will be permanently destroyed on the SSD and cannot be recovered.

### Auto Driver Installer

Allows you to download and install all necessary drivers automatically.

[Enabled]

Select this item to enable the Auto Driver Installer tool. When it is enabled, after entering to Windows with available Internet access, the Auto Driver Installer tool will appear automatically.



[Disabled]

Select this item to disable the Auto Driver Installer tool.

### **Instant Flash**

Allows you to save UEFI files in your USB storage device and run Instant Flash to update your UEFI. Please note that your USB storage device must be FAT32/16/12 file system.

### **Intel MEI Flash**

This function can update and flash Intel MEI. If you can't overclock BCLK or CPU turbo ratio, it can be fixed by this function. You will need BIOS ROM file for MEI Update & Flash. Please note that your USB storage device must be FAT32/16/12 file system.

### 3.6 Hardware Health Event Monitoring Screen

This section allows you to monitor the status of the hardware on your system, including the parameters of the CPU temperature, motherboard temperature, fan speed and voltage.

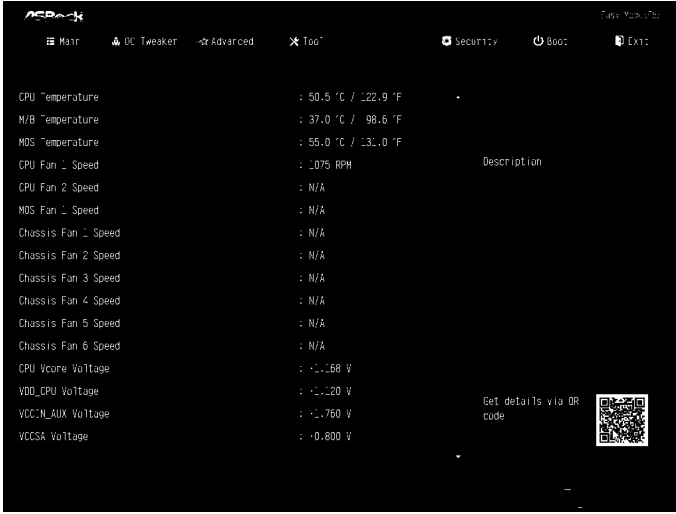

NOTE: Options vary depending on the features of your motherboard.

#### Fan Tuning

When selected, the BIOS will proceed to detect the lowest fan speeds for fans connected to the motherboard. This process will take a few minutes to complete.

Note: Please note CAM settings applied within the OS will overwrite settings made within the BIOS.

## Fan-Tastic Tuning

Allows you to select a fan mode for CPU Fan, or choose Customize to set 5 CPU temperatures and assign a respective fan speed for each temperature.

Select a fan mode or customize the profile

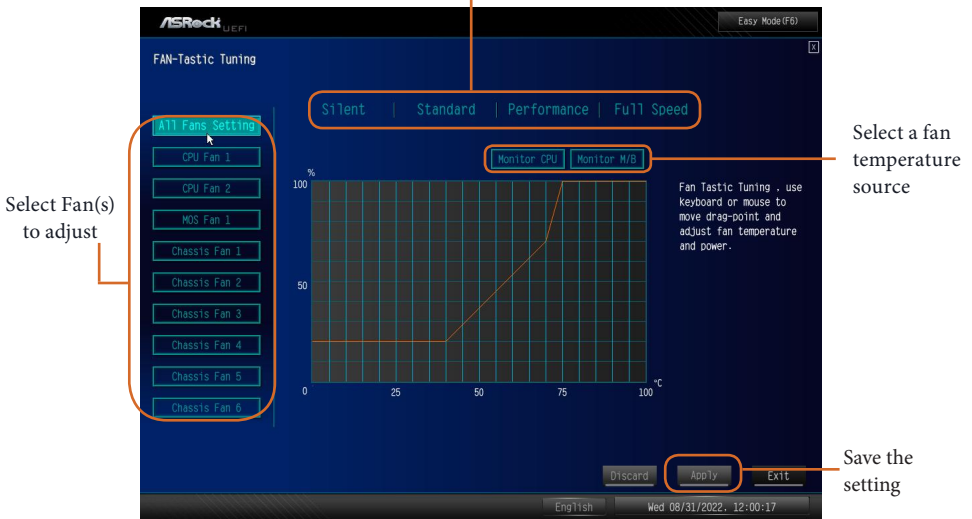

## CPU Fan 1 Setting

Allows you to select a fan mode for CPU Fan 1, or choose [Customize] to set 5 CPU temperatures and assign a respective fan speed for each temperature.

Configuration options:

[Customize] [Silent Mode] [Standard Mode] [Performance Mode] [Full Speed]

## CPU Fan 1 Step Up

Allows you to set the value of CPU Fan 1 Step Up. Configuration options: [Level 0] - [Level 9]

## CPU Fan 1 Step Down

Allows you to set the value of CPU Fan 1 Step Down.

Configuration options: [Level 0] - [Level 9]

## CPU\_FAN2 / W\_PUMP Switch

Allows you to switch CPU\_Fan2 or Water Pump mode.

Configuration options: [CPU\_FAN2] [W\_PUMP]

## CPU Fan 2 Control Mode

Allows you to select PWM mode or DC mode for CPU Fan 2.

[Auto] Select this mode to detect the type of installed fan and automatically switch the control modes.

[DC Mode] Select this mode for 3-pin fan.

[PWM Mode] Select this mode for 4-pin fan.

## CPU Fan 2 Setting

Allows you to select a fan mode for CPU Fan 2, or choose [Customize] to set 5 CPU temperatures and assign a respective fan speed for each temperature.

Configuration options:

[Customize] [Silent Mode] [Standard Mode] [Performance Mode] [Full Speed]

## CPU Fan 2 Temp Source

Allows you to select a fan temperature source for CPU Fan.

[Monitor M/B] Select this item to set motherboard as the fan temperature source.

[Monitor CPU] Select this item to set CPU as the fan temperature source.

## CPU Fan 2 Step Up

Allows you to set the value of CPU Fan 2 Step Up.

Configuration options: [Level 0] - [Level 9]

## CPU Fan 2 Step Down

Allows you to set the value of CPU Fan 2 Step Down.

Configuration options: [Level 0] - [Level 9]

## MOS Fan1 Setting

Allows you to select a fan mode for Fan, or choose Customize to set 5 CPU temperatures and assign a respective fan speed for each temperature.

Configuration options:

[Customize] [Silent Mode] [Standard Mode] [Performance Mode] [Full Speed]

## CHA\_FAN1 / W\_PUMP Switch

Allows you to select Chassis Fan 1 or Water Pump mode.

Configuration options: [CHA\_FAN1] [W\_PUMP]

## Chassis Fan 1 Control Mode

Allows you to select PWM mode or DC mode for Chassis Fan 1.

[Auto] Select this mode to detect the type of installed fan and automatically switch the control modes.

[DC Mode] Select this mode for 3-pin fan.

[PWM Mode] Select this mode for 4-pin fan.

## Chassis Fan 1 Setting

Allows you to select a fan mode for Chassis Fan 1, or choose [Customize] to set 5 CPU temperatures and assign a respective fan speed for each temperature.

Configuration options:

[Customize] [Silent Mode] [Standard Mode] [Performance Mode] [Full Speed]

## Chassis Fan 1 Temp Source

Allows you to select a fan temperature source for Chassis Fan 1.

[Monitor M/B] Select this item to set motherboard as the fan temperature source.

[Monitor CPU] Select this item to set CPU as the fan temperature source.

## Chassis Fan 1 Step Up

Allows you to set the value of Chassis Fan 1 Step Up.

Configuration options: [Level 0] - [Level 9]

## Chassis Fan 1 Step Down

Allows you to set the value of Chassis Fan 1 Step Down.

Configuration options: [Level 0] - [Level 9]

## CHA\_FAN2 / W\_PUMP Switch

Allows you to select Chassis Fan 2 or Water Pump mode.

Configuration options: [CHA\_FAN2] [W\_PUMP]

## Chassis Fan 2 Control Mode

Allows you to select PWM mode or DC mode for Chassis Fan 2.

[Auto] Select this mode to detect the type of installed fan and automatically switch the control modes.

[DC Mode] Select this mode for 3-pin fan.

[PWM Mode] Select this mode for 4-pin fan.

## Chassis Fan 2 Setting

Allows you to select a fan mode for Chassis Fan 2, or choose [Customize] to set 5 CPU temperatures and assign a respective fan speed for each temperature.

Configuration options:

[Customize] [Silent Mode] [Standard Mode] [Performance Mode] [Full Speed]

## Chassis Fan 2 Temp Source

Allows you to select a fan temperature source for Chassis Fan 2.

[Monitor M/B] Select this item to set motherboard as the fan temperature source.

[Monitor CPU] Select this item to set CPU as the fan temperature source.

## Chassis Fan 2 Step Up

Allows you to set the value of Chassis Fan 2 Step Up.

Configuration options: [Level 0] - [Level 9]

## Chassis Fan 2 Step Down

Allows you to set the value of Chassis Fan 2 Step Down.

Configuration options: [Level 0] - [Level 9]

## Chassis Fan 3 Control Mode

Allows you to select PWM mode or DC mode for Chassis Fan 3.

[Auto] Select this mode to detect the type of installed fan and automatically switch the control modes.

[DC Mode] Select this mode for 3-pin fan.

[PWM Mode] Select this mode for 4-pin fan.

## Chassis Fan 3 Setting

Allows you to select a fan mode for Chassis Fan 3, or choose [Customize] to set 5 CPU temperatures and assign a respective fan speed for each temperature.

Configuration options:

[Customize] [Silent Mode] [Standard Mode] [Performance Mode] [Full Speed]

## Chassis Fan 3 Temp Source

Allows you to select a fan temperature source for Chassis Fan 3.

[Monitor M/B] Select this item to set motherboard as the fan temperature source.

[Monitor CPU] Select this item to set CPU as the fan temperature source.

### Chassis Fan 3 Step Up

Allows you to set the value of Chassis Fan 3 Step Up.

Configuration options: [Level 0] - [Level 9]

### Chassis Fan 3 Step Down

Allows you to set the value of Chassis Fan 3 Step Down.

Configuration options: [Level 0] - [Level 9]

### Chassis Fan 4 Control Mode

Allows you to select PWM mode or DC mode for Chassis Fan 4.

[Auto] Select this mode to detect the type of installed fan and automatically switch the control modes.

[DC Mode] Select this mode for 3-pin fan.

[PWM Mode] Select this mode for 4-pin fan.

### Chassis Fan 4 Setting

Allows you to select a fan mode for Chassis Fan 4, or choose [Customize] to set 5 CPU temperatures and assign a respective fan speed for each temperature.

Configuration options:

[Customize] [Silent Mode] [Standard Mode] [Performance Mode] [Full Speed]

### Chassis Fan 4 Temp Source

Allows you to select a fan temperature source for Chassis Fan 4.

[Monitor M/B] Select this item to set motherboard as the fan temperature source.

[Monitor CPU] Select this item to set CPU as the fan temperature source.

### Chassis Fan 4 Step Up

Allows you to set the value of Chassis Fan 4 Step Up.

Configuration options: [Level 0] - [Level 9]

### Chassis Fan 4 Step Down

Allows you to set the value of Chassis Fan 4 Step Down.

Configuration options: [Level 0] - [Level 9]

## Chassis Fan 5 Control Mode

Allows you to select PWM mode or DC mode for Chassis Fan 5.

[Auto] Select this mode to detect the type of installed fan and automatically switch the control modes.

[DC Mode] Select this mode for 3-pin fan.

[PWM Mode] Select this mode for 4-pin fan.

## Chassis Fan 5 Setting

Allows you to select a fan mode for Chassis Fan 5, or choose [Customize] to set 5 CPU temperatures and assign a respective fan speed for each temperature.

Configuration options:

[Customize] [Silent Mode] [Standard Mode] [Performance Mode] [Full Speed]

## Chassis Fan 5 Temp Source

Allows you to select a fan temperature source for Chassis Fan 5.

[Monitor M/B] Select this item to set motherboard as the fan temperature source.

[Monitor CPU] Select this item to set CPU as the fan temperature source.

## Chassis Fan 5 Step Up

Allows you to set the value of Chassis Fan 5 Step Up.

Configuration options: [Level 0] - [Level 9]

## Chassis Fan 5 Step Down

Allows you to set the value of Chassis Fan 5 Step Down.

Configuration options: [Level 0] - [Level 9]

## Chassis Fan 6 Control Mode

Allows you to select PWM mode or DC mode for Chassis Fan 6.

[Auto] Select this mode to detect the type of installed fan and automatically switch the control modes.

[DC Mode] Select this mode for 3-pin fan.

[PWM Mode] Select this mode for 4-pin fan.

## Chassis Fan 6 Setting

Allows you to select a fan mode for Chassis Fan 6, or choose [Customize] to set 5 CPU



temperatures and assign a respective fan speed for each temperature.

Configuration options:

[Customize] [Silent Mode] [Standard Mode] [Performance Mode] [Full Speed]

### Chassis Fan 6 Temp Source

Allows you to select a fan temperature source for Chassis Fan 6.

[Monitor M/B] Select this item to set motherboard as the fan temperature source.

[Monitor CPU] Select this item to set CPU as the fan temperature source.

### Chassis Fan 6 Step Up

Allows you to set the value of Chassis Fan 6 Step Up.

Configuration options: [Level 0] - [Level 9]

### Chassis Fan 6 Step Down

Allows you to set the value of Chassis Fan 6 Step Down.

Configuration options: [Level 0] - [Level 9]

## 3.7 Security Screen

In this section you may set or change the supervisor/user password for the system. You may also clear the user password.

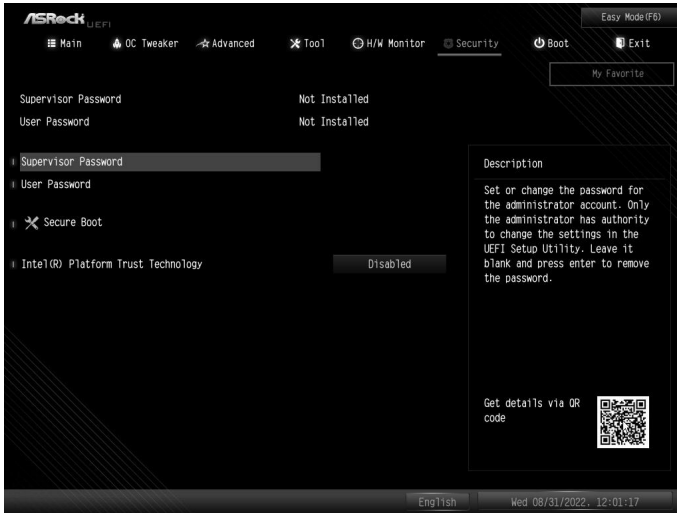

### Supervisor Password

Set or change the password for the administrator account. Only the administrator has authority to change the settings in the UEFI Setup Utility. Leave it blank and press enter to remove the password.

### User Password

Set or change the password for the user account. Users are unable to change the settings in the UEFI Setup Utility. Leave it blank and press enter to remove the password.

### Secure Boot

Press [Enter] to configure the Secure Boot Settings. The feature protects the system from unauthorized access and malwares during POST.

### Secure Boot Mode

[Standard] Select this item and the system will automatically load the Secure Boot keys from the BIOS database.

[Custom] Select this item and Secure Boot Policy variables can be configured by a physically present user without full authentication.

## Install Default Secure Boot Keys

Please install default secure boot keys if it's the first time you use secure boot.

## Clear Secure Boot Keys

This item appears only when you load the default Secure Boot keys. Use this item to clear all default Secure Boot keys.

## Key Management

This item enables expert users to modify Secure Boot Policy variables without full authentication. This appears only when you set Secure Boot Mode to [Custom].

## Factory Key Provision

Allows you to install factory default Secure Boot keys after the platform reset and while the System is in Setup mode.

## Install Default Secure Boot Keys

Please install default secure boot keys if it's the first time you use secure boot.

## Clear Secure Boot Keys

This item appears only when you load the default Secure Boot keys. Use this item to clear all default Secure Boot keys.

## Enroll Efi Image

Allows Efi image to run in Secure Boot Mode. Enroll SHA256 Hash certificate of a PE image into Authorized Signature Database (db).

## Export Secure Boot variables

Allows you to copy NVRAM content of Secure Boot variables to files in a root folder on a file\_system device.

## Platform Key(PK)

Enroll Factory Defaults or load certificates from a file:

1. Public Key Certificate:

- a) EFI\_SIGNATURE\_LIST
- b) EFI\_CERT\_X509 (DER)
- c) EFI\_CERT\_RSA2048 (bin)
- d) EFI\_CERT\_SHAXXX

2. Authenticated UEFI Variable
3. EFI PE/COFF Image(SHA256)

Key Source: Factory, Modified, Mixed

## Key Exchange Keys

Enroll Factory Defaults or load certificates from a file:

1. Public Key Certificate:
  - a) EFI\_SIGNATURE\_LIST
  - b) EFI\_CERT\_X509 (DER)
  - c) EFI\_CERT\_RSA2048 (bin)
  - d) EFI\_CERT\_SHAXXX
2. Authenticated UEFI Variable
3. EFI PE/COFF Image(SHA256)

Key Source: Factory, Modified, Mixed

## Authorized Signatures

Enroll Factory Defaults or load certificates from a file:

1. Public Key Certificate:
  - a) EFI\_SIGNATURE\_LIST
  - b) EFI\_CERT\_X509 (DER)
  - c) EFI\_CERT\_RSA2048 (bin)
  - d) EFI\_CERT\_SHAXXX
2. Authenticated UEFI Variable
3. EFI PE/COFF Image(SHA256)

Key Source: Factory, Modified, Mixed

## Forbidden Signatures

Enroll Factory Defaults or load certificates from a file:

1. Public Key Certificate:
  - a) EFI\_SIGNATURE\_LIST
  - b) EFI\_CERT\_X509 (DER)
  - c) EFI\_CERT\_RSA2048 (bin)

d) EFI\_CERT\_SHAXXX

2. Authenticated UEFI Variable

3. EFI PE/COFF Image(SHA256)

Key Source: Factory, Modified, Mixed

### Authorized TimeStamps

Enroll Factory Defaults or load certificates from a file:

1. Public Key Certificate:

a) EFI\_SIGNATURE\_LIST

b) EFI\_CERT\_X509 (DER)

c) EFI\_CERT\_RSA2048 (bin)

d) EFI\_CERT\_SHAXXX

2. Authenticated UEFI Variable

3. EFI PE/COFF Image(SHA256)

Key Source: Factory, Modified, Mixed

### OsRecovery Signatures

Enroll Factory Defaults or load certificates from a file:

1. Public Key Certificate:

a) EFI\_SIGNATURE\_LIST

b) EFI\_CERT\_X509 (DER)

c) EFI\_CERT\_RSA2048 (bin)

d) EFI\_CERT\_SHAXXX

2. Authenticated UEFI Variable

3. EFI PE/COFF Image(SHA256)

Key Source: Factory, Modified, Mixed

### Intel(R) Platform Trust Technology

Allows you to enable or disable Intel PTT function.

[Enabled] Enables Intel PTT in ME.

[Disabled] Disables Intel PTT in ME. Use a discrete TPM Module.

Configuration options: [Enabled] [Disabled]

## 3.8 Boot Screen

This section displays the available devices on your system for you to configure the boot settings and the boot priority.



### Boot Option #1

Allows you to set the system boot order.

### Fast Boot

Fast Boot speeds up your computer's boot time; however, you won't be able to boot from an USB storage device. Ultra Fast mode is supported by UEFI aware OS or later versions, and a VBIOS that supports UEFI GOP is required if you are using an external graphics card. Please note that Ultra Fast mode boots so fast that the only way to enter this UEFI Setup Utility is to clear CMOS or run the Restart to UEFI utility in Windows.

Configuration options: [Disabled] [Ultra Fast]

### Boot From Onboard LAN

Allows the system to be waked up by the onboard LAN.

Configuration options: [Enabled] [Disabled]

### Setup Prompt Timeout

Allows you to configure the number of seconds to wait for the UEFI setup utility.

Configuration options: [1] - [65535]

## Bootup Num-Lock

Allows you to select whether Num Lock should be turned on or off when the system boots up.

Configuration options: [On] [Off]

## Boot Beep

Allows you to select whether the Boot Beep should be turned on or off when the system boots up. Please note that a buzzer is needed.

Configuration options: [Enabled] [Disabled]

## Full Screen Logo

[Enabled] Select this item to display the boot logo.

[Disabled] Select this item to show normal POST messages.

## AddOn ROM Display

Allows you to set display mode for Option ROM.

[Enabled]

Select this item to enable AddOn ROM Display to see the AddOn ROM messages or configure the AddOn ROM if you've enabled Full Screen Logo.

[Disabled]

Select this item to disable AddOn ROM Display for faster boot speed.

## Boot Failure Guard Message

If the computer fails to boot for a number of times the system automatically restores the default settings.

Configuration options: [Enabled] [Disabled]

## Boot Failure Guard Count

Allows you to configure the number of attempts to boot until the system automatically restores the default settings

Configuration options: [2] - [250]

## CSM (Compatibility Support Module)



### CSM

Allows you to enable and launch the Compatibility Support Module. Please do not disable unless you're running a WHCK test.

### Launch PXE OpROM Policy

[UEFI only] Select this item to run those that support UEFI option ROM only.

[Do not launch] Select this item to not execute both legacy and UEFI option ROM.

[Legacy only] Select this item to run those that support Legacy option ROM only.

### Launch Storage OpROM Policy

[UEFI only] Select this item to run those that support UEFI option ROM only.

[Do not launch] Select this item to not execute both legacy and UEFI option ROM.

[Legacy only] Select this item to run those that support Legacy option ROM only.

### Other PCI Device ROM Priority

Allows you to select whether to enable the UEFI or Legacy option ROM for the PCI device controller other than the network, mass storage device, and video graphics controllers.

Configuration options: [Do not launch] [UEFI only] [Legacy only]



## 3.9 Exit Screen

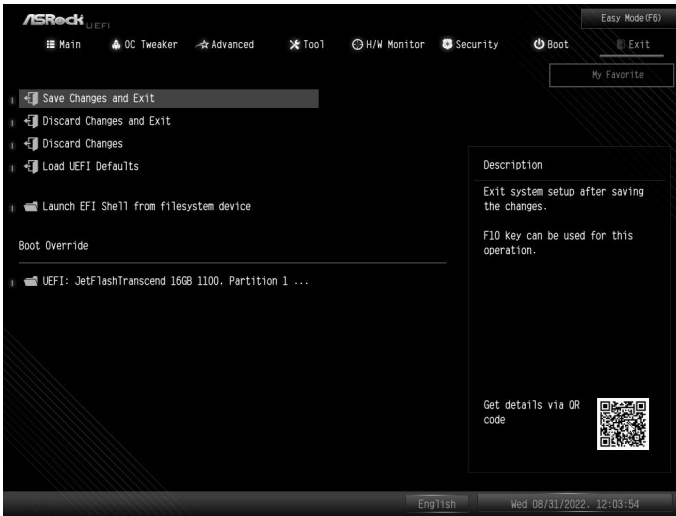

### Save Changes and Exit

When you select this option the following message, “Save configuration changes and exit setup?” will pop out. Press <F10> key or select [Yes] to save the changes and exit the UEFI SETUP UTILITY.

### Discard Changes and Exit

When you select this option the following message, “Discard changes and exit setup?” will pop out. Press <ESC> key or select [Yes] to exit the UEFI SETUP UTILITY without saving any changes.

### Discard Changes

When you select this option the following message, “Discard changes?” will pop out. Press <F7> key or select [Yes] to discard all changes.

### Load UEFI Defaults

Allows you to load UEFI default values for all options. The F9 key can be used for this operation.

### Launch EFI Shell from filesystem device

Allows you to copy shellx64.efi to the root directory to launch EFI Shell.