

# Quick Start Guide

## ROG Rapture GT6

ROG Rapture AX10000 Tri-band Gaming Mesh Router

Model: GT6

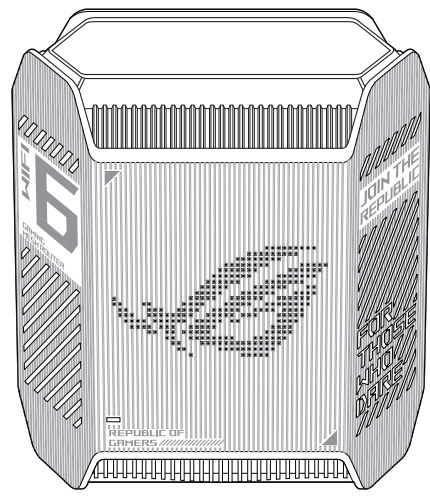

## Hardware Explanations

### GT6 I/O Overview

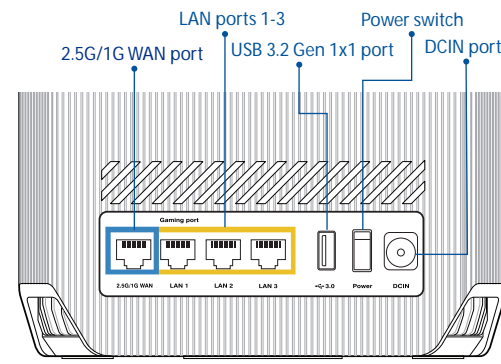

- 2.5G / 1G WAN port  
Connect your modem to this WAN port with a network cable.
- LAN ports 1-3  
Connect your PC to a LAN port with a network cable.

### GT6 LED Overview

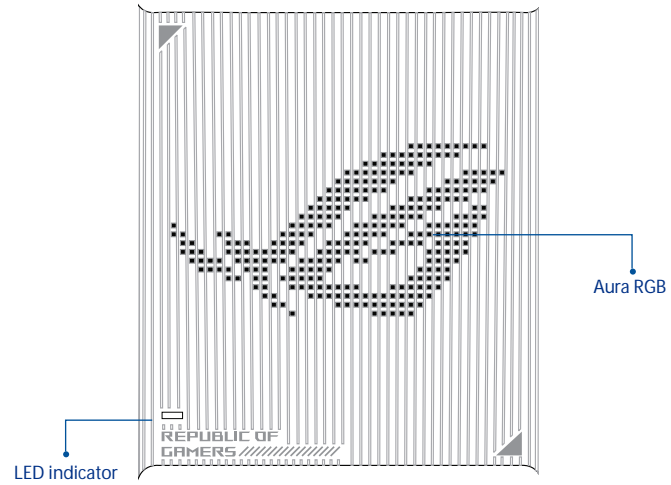

### ROG Rapture GT6 LED indicator

- Solid blue  
Your ROG Rapture GT6 is ready for setup.
- Solid white  
Your ROG Rapture GT6 is online and works well.
- Solid red  
Your ROG Rapture GT6 router has no Internet connection. / Your node is disconnected from the router.
- Solid yellow  
The signal between your ROG Rapture GT6 router and the node is weak.

### Specifications:

DC Power adapter	DC Output: +19V with max 2.37A current DC Output: +19.5V with max 2.31A current		
Operating Temperature	0~40°C	Storage	0~70°C
Operating Humidity	50~90%	Storage	20~90%

## Before Setup

### Preparing to set up an AiMesh WiFi system

- 1 Find two ROG Rapture GT6, and power them on.
- 2 Use a network cable to connect your modem to the WAN port of either ROG Rapture GT6. This ROG Rapture GT6 will be the AiMesh router, and the other ROG Rapture GT6 will be the AiMesh node.
- 3 The LED indicator turns solid blue to indicate that ROG Rapture GT6 is ready for setup.

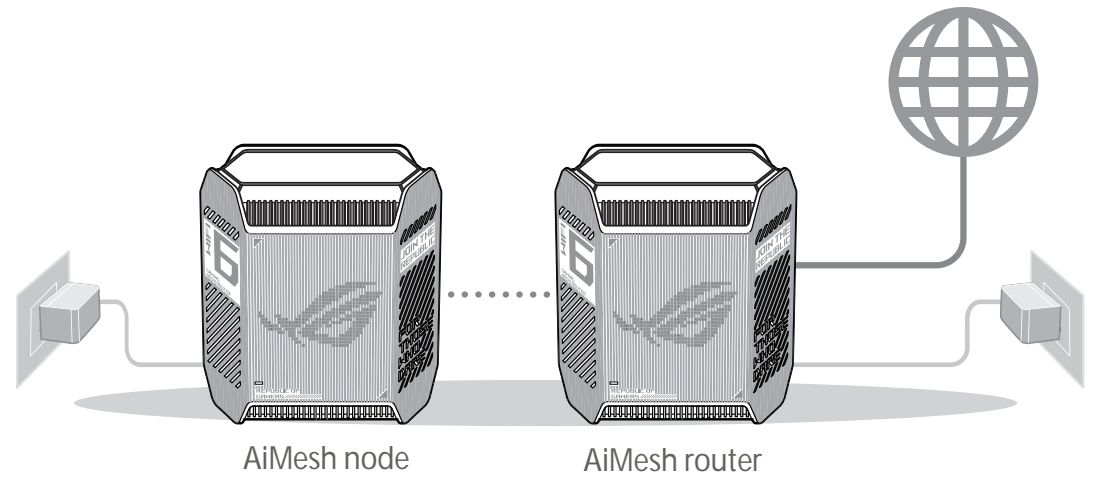

## ASUS Router App

Download free ASUS Router APP to set up and manage your router(s).

ASUS Router



## AiMesh Setup Steps

### 01 Prepare

Place your ROG Rapture GT6 router and node within 1~3 meters of each other during the setup process.

### 02 AiMesh node

Keep your AiMesh node powered on and standby for AiMesh system settings.

### 03 Launching ASUS Router APP

Launch ASUS Router APP, and then follow the on-screen instructions to finish the AiMesh setup.

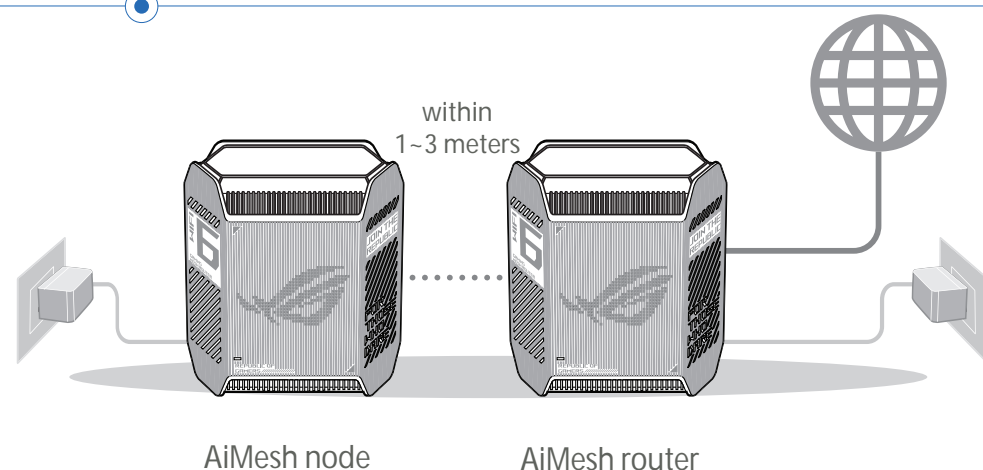

**NOTES:** When you're using a wireless backhaul to connect your router and AiMesh node, the WAN port on your AiMesh node can be used as a LAN port providing up to 2.5G transmission speed.

# Troubleshooting

If your AiMesh router cannot find any AiMesh node nearby or synchronization fails, please check the following and try again.

- Move your AiMesh node closer to the AiMesh router ideally. Ensure that it is within 1~3 meters.
- Your AiMesh node is powered on.

# Relocation THE BEST PERFORMANCE

Locate the AiMesh router and node at the best place.

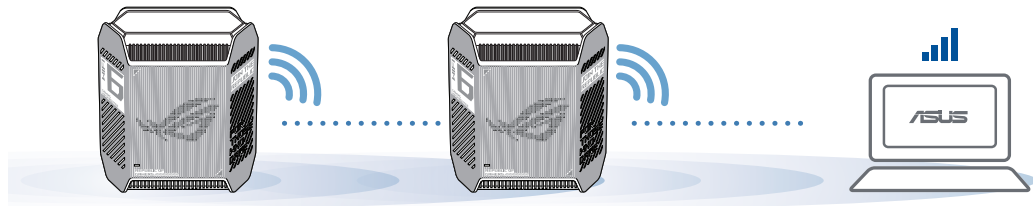

**NOTES:** To minimize interference, keep the routers away from devices like cordless phones, Bluetooth devices and microwave ovens.

We recommend that you place the routers in an open or spacious location.

# FAQ FREQUENTLY ASKED QUESTIONS

**Q1:** Does the AiMesh router support Access Point mode?

**A: Yes.** You can choose to set the AiMesh router as router mode or access point mode. Please go to web GUI (<http://www.asusrouter.com>), and go to the page **Administration > Operation Mode**.

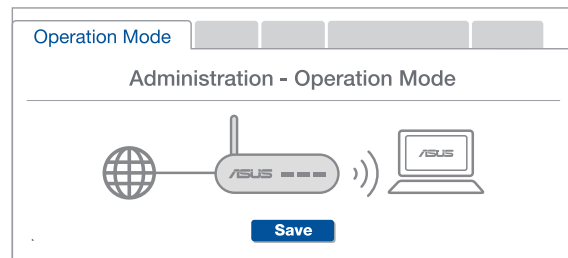

**Q2:** Could I setup wired connection between AiMesh routers (Ethernet backhaul)?

**A: Yes.** AiMesh system supports both wireless and wired connection between AiMesh router and node to maximize throughput and stability. AiMesh analyzes the wireless signal strength for each frequency band available, and then determines automatically whether a wireless or wired connection is best to serve as the inter-router connection backbone.

- Follow the setup steps to establish a connection between the AiMesh router and node via WiFi first.
- Place the node in the ideal locations for best coverage. Run an Ethernet cable from the LAN port of the AiMesh router to the WAN port of AiMesh node.

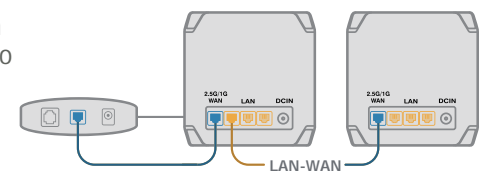

- AiMesh system will auto-select the best path for data transmission, whether wired or wireless.

## ASUS Recycling/Takeback Services

ASUS recycling and takeback programs come from our commitment to the highest standards for protecting our environment. We believe in providing solutions for you to be able to responsibly recycle our products, batteries, other components, as well as the packaging materials. Please go to <http://csr.asus.com/english/Takeback.htm> for the detailed recycling information in different regions.

## REACH

Complying with the REACH (Registration, Evaluation, Authorisation, and Restriction of Chemicals) regulatory framework, we published the chemical substances in our products at ASUS REACH website at <http://csr.asus.com/english/REACH.htm>

## Federal Communications Commission Statement

This device complies with Part 15 of the FCC Rules. Operation is subject to the following two conditions:

- This device may not cause harmful interference.
- This device must accept any interference received, including interference that may cause undesired operation.

This equipment has been tested and found to comply with the limits for a class B digital device, pursuant to part 15 of the FCC Rules. These limits are designed to provide reasonable protection against harmful interference in a residential installation.

This equipment generates, uses and can radiate radio frequency energy and, if not installed and used in accordance with the instructions, may cause harmful interference to radio communications. However, there is no guarantee that interference will not occur in a particular installation. If this equipment does cause harmful interference to radio or television reception, which can be determined by turning the equipment off and on, the user is encouraged to try to correct the interference by one or more of the following measures:

- Reorient or relocate the receiving antenna.
- Increase the separation between the equipment and receiver.
- Connect the equipment into an outlet on a circuit different from that to which the receiver is connected.
- Consult the dealer or an experienced radio/TV technician for help.

**WARNING!** Any changes or modifications not expressly approved by the party responsible for compliance could void the user's authority to operate the equipment.

## Prohibition of Co-location

This device and its antenna(s) must not be co-located or operating in conjunction with any other antenna or transmitter.

## IMPORTANT NOTE:

**Radiation Exposure Statement:** This equipment complies with FCC radiation exposure limits set forth for an uncontrolled environment. End users must follow the specific operating instructions for satisfying RF exposure compliance. To maintain compliance with FCC exposure compliance requirement, please follow operation instruction as documented in this manual.

**WARNING!** This equipment must be installed and operated in accordance with provided instructions and the antenna(s) used for this transmitter must be installed to provide a separation distance of at least 62 cm from all persons and must not be co-located or operating in conjunction with any other antenna or transmitter.

## Compliance Statement of Innovation, Science and Economic Development Canada (ISED)

This device complies with Innovation, Science and Economic Development Canada licence exempt RSS standard(s). Operation is subject to the following two conditions: (1) this device may not cause interference, and (2) this device must accept any interference, including interference that may cause undesired operation of the device.

Operation in the band 5150–5250 MHz is only for indoor use to reduce the potential for harmful interference to co-channel mobile satellite systems.

CAN ICES-003(B)/NMB-003(B)

## Radio Frequency (RF) Exposure Information

The radiated output power of the ASUS Wireless Device is below the Innovation, Science and Economic Development Canada radio frequency exposure limits. The ASUS Wireless Device should be used in such a manner such that the potential for human contact during normal operation is minimized.

This equipment should be installed and operated with a minimum distance of 31 cm between the radiator any part of your body.

This device has been certified for use in Canada. Status of the listing in the Innovation, Science and Economic Development Canada's REL (Radio Equipment List) can be found at the following web address:

[http://www.ic.gc.ca/eic/site/ceb-bhst.nsf/eng/h\\_tt00020.html](http://www.ic.gc.ca/eic/site/ceb-bhst.nsf/eng/h_tt00020.html)

Additional Canadian information on RF exposure also can be found at the following web:

<https://www.ic.gc.ca/eic/site/smt-gst.nsf/eng/sf08792.html>

## Déclaration de conformité de Innovation, Sciences et Développement économique Canada (ISED)

Le présent appareil est conforme aux CNR d'Innovation, Sciences et Développement économique Canada applicables aux appareils radio exempts de licence. L'exploitation est autorisée aux deux conditions suivantes : (1) l'appareil ne doit pas produire de brouillage, et (2) l'utilisateur de l'appareil doit accepter tout brouillage radioélectrique subi, même si le brouillage est susceptible d'en compromettre le fonctionnement.

La bande 5150 – 5250 MHz est réservée uniquement pour une utilisation à l'intérieur afin de réduire les risques de brouillage préjudiciable aux systèmes de satellites mobiles utilisant les mêmes canaux.

CAN ICES-003(B)/NMB-003(B)

## Informations concernant l'exposition aux fréquences radio (RF)

La puissance de sortie émise par cet appareil sans fil est inférieure à la limite d'exposition aux fréquences radio d'Innovation, Sciences et Développement économique du Canada (ISED). Utilisez l'appareil sans fil de façon à minimiser les contacts humains lors d'un fonctionnement normal.

Cet équipement doit être installé et utilisé avec un minimum de 31 cm de distance entre la source de rayonnement et votre corps.

L'utilisation de cet appareil est autorisée au Canada. Pour consulter l'entrée correspondant à l'appareil dans la liste d'équipement radio (REL - Radio Equipment List) d'Innovation, Sciences et Développement économique du Canada, rendez-vous sur :

[http://www.ic.gc.ca/eic/site/ceb-bhst.nsf/eng/h\\_tt00020.html](http://www.ic.gc.ca/eic/site/ceb-bhst.nsf/eng/h_tt00020.html)

Pour des informations supplémentaires concernant l'exposition aux fréquences radio au Canada, rendez-vous sur : <https://www.ic.gc.ca/eic/site/smt-gst.nsf/eng/sf08792.html>

For product available in the US/Canada market, only channel 1~11 can be operated. Selection of other channels is not possible.

Pour les produits disponibles aux États-Unis et au Canada, seuls les canaux 1 à 11 peuvent être utilisés. La sélection d'autres canaux n'est pas possible.

FCC regulations restrict the operation of this device to indoor use only.

This device is restricted for indoor use only.

Cet appareil convient uniquement à un usage intérieur.

## Safety Notices

- Use this product in environments with ambient temperatures between 0°C(32°F) and 40°C(104°F).
- Refer to the rating label on the bottom of your product and ensure your power adapter complies with this rating.
- DO NOT place on uneven or unstable work surfaces. Seek servicing if the casing has been damaged.
- DO NOT place or drop objects on top and do not shove any foreign objects into the product.
- DO NOT expose to or use near liquids, rain, or moisture. DO NOT use the modem during electrical storms.
- DO NOT cover the vents on the product to prevent the system from getting overheated.
- DO NOT use damaged power cords, accessories, or other peripherals.
- If the Adapter is broken, do not try to fix it by yourself. Contact a qualified service technician or your retailer.
- To prevent electrical shock hazard, disconnect the power cable from the electrical outlet before relocating the system.
- DO NOT mount this equipment higher than 2 meters.

- Utilisez ce produit dans un environnement dont la température ambiante est comprise entre 0°C (32°F) et 40°C (104°F).
- Référez-vous à l'étiquette située au dessous du produit pour vérifier que l'adaptateur secteur répond aux exigences de tension.
- NE PAS placer sur une surface irrégulière ou instable. Contactez le service après-vente si le châssis a été endommagé.
- NE PAS placer, faire tomber ou insérer d'objets sur/dans le produit.
- NE PAS exposer l'appareil à la pluie ou à l'humidité, tenez-le à distance des liquides. NE PAS utiliser le modem lors d'un orage.
- NE PAS bloquer les ouvertures destinées à la ventilation du système pour éviter que celui-ci ne surchauffe.
- NE PAS utiliser de cordons d'alimentation, d'accessoires ou autres périphériques endommagés.
- Si l'adaptateur est endommagé, n'essayez pas de le réparer vous-même. Contactez un technicien électrique qualifié ou votre revendeur.
- Pour éviter tout risque de choc électrique, débranchez le câble d'alimentation de la prise électrique avant de toucher au système.
- Ne placez pas cet appareil à une hauteur supérieure à 2 mètres.