

CO-FH02 User's Guide

Contents

CO-FH02 User's Guide	9
Introduction to Your Projector	10
Projector Features.....	10
Product Box Contents.....	11
Additional Components	12
Warranty and Registration Information (U.S. and Canada)	12
Warranty and Registration Information (Latin America).....	13
Notations Used in the Documentation	13
Where to Go for Additional Information	13
Projector Part Locations	13
Projector Parts - Front/Top	14
Projector Parts - Side.....	15
Projector Parts - Rear	16
Projector Parts - Base.....	17
Projector Parts - Remote Control.....	18
Setting Up the Projector	22
Projector Placement.....	22
Projector Setup and Installation Options	22
Projection Distance.....	24
Projector Connections	28
Connecting to an HDMI Video Source	28
Connecting to a Streaming Media Player	29
Connecting to a Bluetooth Audio Device	31
Installing Batteries in the Remote Control	32
Setting Up Android TV.....	33
Using Basic Projector Features	35
Turning On the Projector	35
Using the Home Screen.....	37
Turning Off the Projector	38
Pairing the Remote Control	39

Remote Control Operation	40
Selecting the Language for the Projector Menus.....	40
Projection Modes	41
Changing the Projection Mode Using the Menus.....	41
Adjusting the Image Height	42
Adjusting the Image Position Using Image Shift.....	43
Image Aspect Ratio	44
Changing the Image Aspect Ratio	44
Available Image Aspect Ratios	44
Image Shape.....	45
Correcting Image Shape with H/V Keystone.....	45
Correcting Image Shape with Quick Corner	47
Focusing the Image Using the Focus Lever	48
Resizing the Image Using Zoom	49
Displaying a Test Pattern	49
Color Mode.....	50
Changing the Color Mode.....	50
Available Color Modes.....	50
Adjusting Picture Quality in Detail	51
Using Voice Commands to Control Your Projector.....	52
Using Your Projector as a Chromecast	52
Controlling the Volume with the Volume Buttons.....	53
Adjusting Projector Features	54
Operating Connected Devices Using the HDMI Link Features.....	54
Shutting Off the Picture and Sound Temporarily	55
Zooming Into and Out of Images	56
Projector Security Features.....	57
Password Security Types	57
Setting a Password	57
Selecting Password Security Types.....	58
Entering a Password to Use the Projector.....	59
Saving a User's Logo Image to Display.....	60
Creating a User Pattern to Display	61

Installing a Security Cable	62
Copying Menu Settings Between Projectors	62
Saving Settings to a USB Flash Drive.....	63
Transferring Settings from a USB Flash Drive	64
Saving Settings to a Computer	64
Transferring Settings from a Computer	65
Adjusting the Menu Settings	67
Using the Projector's Menus.....	67
Image Quality Settings - Image Menu	68
Projector Feature Settings - Settings Menu.....	70
Projector Information Display - Info Menu	75
Projector Reset Options - Reset Menu	76
Maintaining and Transporting the Projector	77
Projector Maintenance	77
Cleaning the Lens.....	77
Cleaning the Projector Case.....	78
Cleaning the Air Vents	78
Replacing the Remote Control Batteries	79
Transporting the Projector.....	81
Solving Problems	82
Projection Problem Tips	82
Projector Light Status	83
Solving Projector or Remote Control Operation Problems	84
Solutions to Projector Power or Shut-Off Problems	85
Solutions to Remote Control Problems.....	85
Solving Image or Sound Problems	86
Solutions When No Image Appears.....	87
Solutions When "No Signal" Message Appears.....	88
Displaying From a PC Laptop	88
Displaying From a Mac Laptop	89
Solutions When the Image is Not Rectangular	89
Solutions When the Image is Fuzzy or Blurry	89
Solutions When Only a Partial Image Appears.....	90

Solutions When the Image Contains Noise or Static	91
Solutions When the Image is Flickering	91
Solutions When the Image Brightness or Colors are Incorrect	92
Solutions When the Image is Upside Down	92
Solutions to Sound Problems	92
Solutions to Streaming Device Problems	93
Solutions to HDMI Link Problems	94
Solutions When a Message to Replace the Projector is Displayed	94
Where to Get Help (U.S. and Canada)	95
Where to Get Help (Latin America).....	96
Technical Specifications	98
General Projector Specifications	98
Projector Lamp Specifications	99
Remote Control Specifications	100
Projector Dimension Specifications	100
Projector Electrical Specifications	100
Projector Environmental Specifications	101
Streaming Device Specifications	101
Bluetooth Specifications	102
Projector Safety and Approvals Specifications	102
Supported Video Display Formats	103
Notices	105
Recycling (U.S. and Canada)	105
Important Safety Information	105
Important Safety Instructions	106
Restriction of Use	109
Warning Labels	110
List of Safety Symbols	110
Wireless Safety Instructions	114
FCC Compliance Statement	115
Binding Arbitration and Class Waiver	116
Trademarks	119
Copyright Notice	120

A Note Concerning Responsible Use of Copyrighted Materials.....	121
Copyright Attribution	121

CO-FH02 User's Guide

Welcome to the CO-FH02 *User's Guide*.

For a printable PDF copy of this guide, [click here](#).

Introduction to Your Projector

Refer to these sections to learn more about your projector and this manual.

[Projector Features](#)

[Notations Used in the Documentation](#)

[Where to Go for Additional Information](#)

[Projector Part Locations](#)

Projector Features

The CO-FH02 projector includes these special features:

Bright, high-resolution projection system

- Up to 3000 lumens of color brightness (color light output) and white brightness (white light output)

Note: Color brightness (color light output) and white brightness (white light output) will vary depending on usage conditions. Color light output measured in accordance with IDMS 15.4; white light output measured in accordance with ISO 21118.

- FullHD 1080p image resolution
- Advanced 3LCD technology
- Up to 391 inches (993 cm) projected image size (no screen required)
- Automatic vertical keystone adjustment

Flexible connectivity

- Included Android TV streaming stick with Chromecast functionality and Bluetooth wireless speaker support
- HDMI port for streaming devices or other HDMI sources
- One remote controls projector and connected HDMI CEC devices
- Small, portable design
- 5W internal speaker

[Product Box Contents](#)

[Additional Components](#)

[Warranty and Registration Information \(U.S. and Canada\)](#)

Product Box Contents

Save all the packaging in case you need to ship the projector. Always use the original packaging (or equivalent) when shipping.

Make sure your projector box included all of these parts:

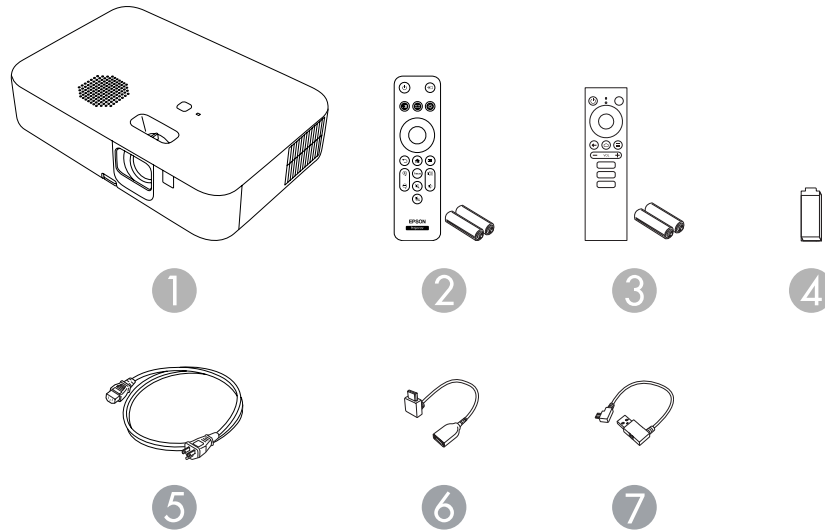

- 1 Projector
- 2 Projector remote control and 2 AAA batteries
- 3 Streaming device remote control and 2 AAA batteries
- 4 Android TV streaming media player
- 5 Power cord
- 6 HDMI extension cable
- 7 USB power cable

Additional Components

Depending on how you plan to use the projector, you may need to obtain additional components.

Note: To connect a Mac that does not include a compatible HDMI output port, you need to obtain an adapter that allows you to connect to the HDMI port on the projector. Contact Apple for compatible HDMI adapter options. To connect a smartphone or tablet, you may need to obtain an adapter that allows you to connect to the projector. This allows you to mirror your smartphone or tablet screens, watch movies, and more. Contact your device manufacturer for compatible adapter options.

Note: The projector's HDMI port does not support MHL.

Unless listed as available from Epson in this table, see your local computer or electronics dealer for purchase information.

Signal or connection type	Additional component necessary
HDMI	Compatible HDMI cable U.S. and Canada: Available for purchase from Epson or an authorized Epson reseller. Latin America: Available for purchase from an authorized Epson reseller. Note: Older Mac computers (2009 and earlier) may not support HDMI audio.

Parent topic: [Projector Features](#)

Warranty and Registration Information (U.S. and Canada)

Your projector comes with a basic warranty that lets you project with confidence. For details, see the warranty brochure that came with your projector.

Register your product online at this site: epson.com/webreg

Registering also lets you receive special updates on new accessories, products, and services.

Parent topic: [Projector Features](#)

Warranty and Registration Information (Latin America)

Your projector comes with a basic warranty that lets you project with confidence. For details, see the warranty that came with your projector.

Register your product online at latin.epson.com/support, search for your product, and select **Register**.

Registering also lets you receive special updates on new accessories, products, and services.

Parent topic: [Projector Features](#)

Notations Used in the Documentation

Follow the guidelines in these notations as you read your documentation:

- **Warnings** must be followed carefully to avoid bodily injury.
- **Cautions** must be observed to avoid damage to your equipment.
- **Notes** contain important information about your projector.
- **Tips** contain additional projection information.

Parent topic: [Introduction to Your Projector](#)

Where to Go for Additional Information

Need quick help on using your projector? Here's where to look for help:

- <https://support.google.com/androidtv/> for Android TV support
- epson.com/support (U.S.), epson.ca/support (Canada), or latin.epson.com/support (Caribbean)

View FAQs (frequently asked questions) and e-mail your questions to Epson technical support 24 hours a day.

- If you still need help after checking this manual and any other sources listed here, you can use the Epson PrivateLine Support service to get help fast (U.S. and Canada only). For details, see "Where to Get Help."

Parent topic: [Introduction to Your Projector](#)

Projector Part Locations

Check the projector part illustrations to learn about the parts on your projector.

[Projector Parts - Front/Top](#)

[Projector Parts - Side](#)

[Projector Parts - Rear](#)

[Projector Parts - Base](#)

[Projector Parts - Remote Control](#)

Parent topic: [Introduction to Your Projector](#)

Projector Parts - Front/Top

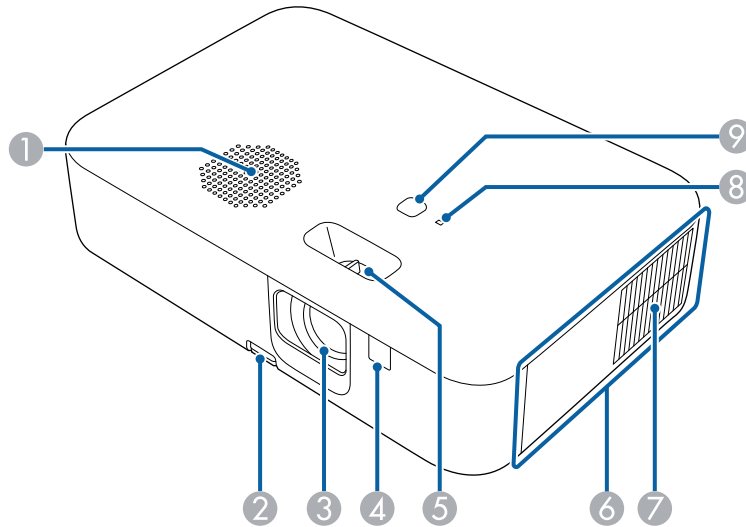

- 1 Speaker
- 2 Foot release lever
- 3 Lens
- 4 Remote receiver
- 5 Focus lever
- 6 Side cover (remove to access interface ports)
- 7 Air intake vent
- 8 Status light
- 9 Power button

Parent topic: [Projector Part Locations](#)

Projector Parts - Side

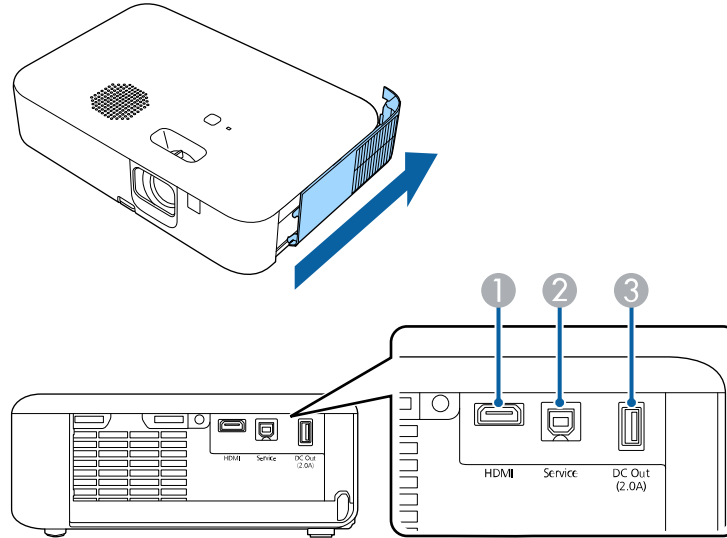

Slide the side cover to the rear of the projector to access the interface ports.

- 1 **HDMI** port
- 2 **Service** port
- 3 **DC Out (2.0A)** port

Parent topic: [Projector Part Locations](#)

Related tasks

[Cleaning the Air Vents](#)

Projector Parts - Rear

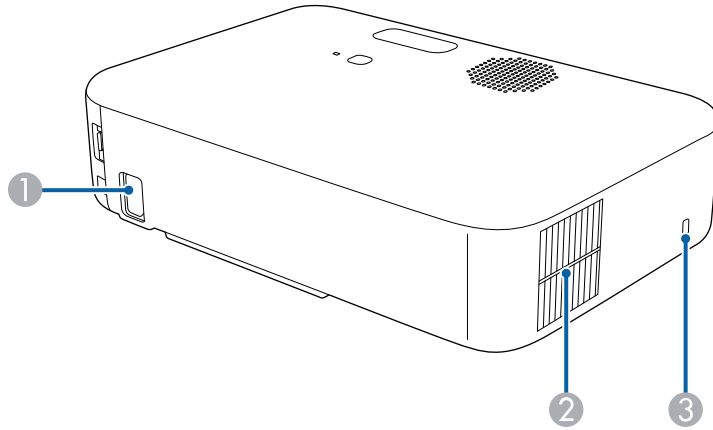

- 1 AC power inlet
- 2 Air exhaust vent
- 3 Kensington security slot

Warning: While projecting, do not put your face or hands near the air exhaust vents, and do not place objects that may become warped or damaged by heat near the vents. Hot air from the air exhaust vents could cause burns or other injuries, or warping of projector parts.

Warning: Do not look into the vents. If the lamp explodes, gases may escape and small fragments of glass may be scattered which could cause an injury. Contact a doctor if any fragments of broken glass are inhaled or get into the eyes or mouth.

Parent topic: [Projector Part Locations](#)

Related tasks

[Installing a Security Cable](#)

[Cleaning the Air Vents](#)

Projector Parts - Base

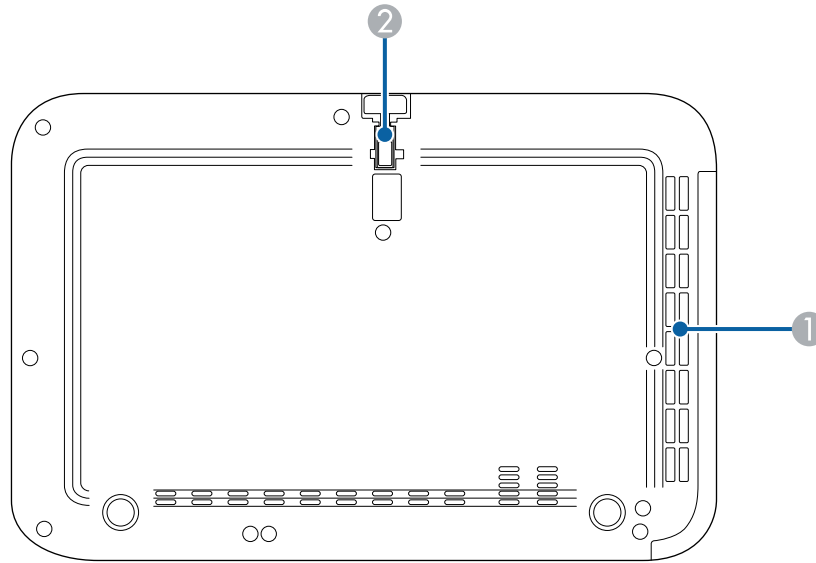

- 1 Air intake vent
- 2 Front adjustable foot

Parent topic: [Projector Part Locations](#)

Related tasks







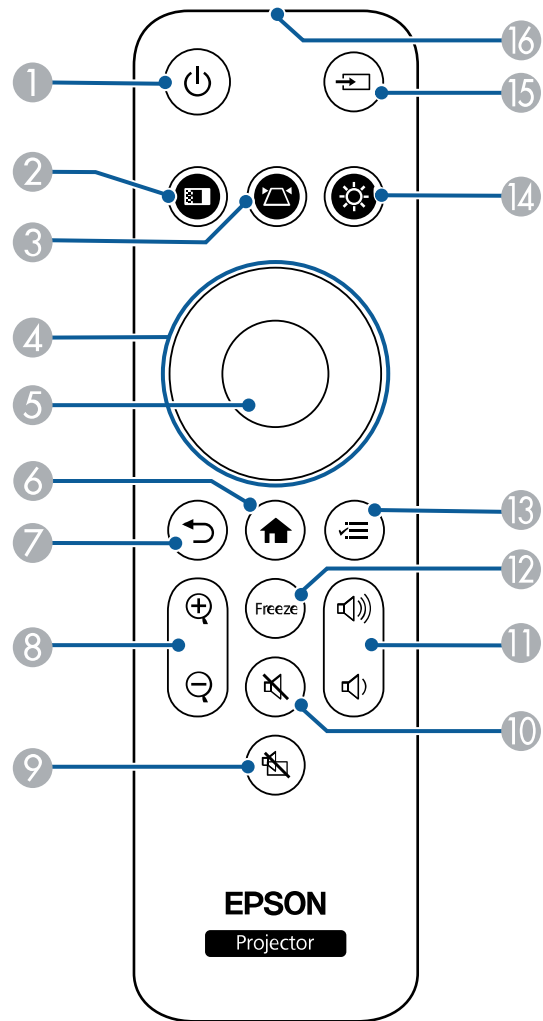





[Cleaning the Air Vents](#)

Projector Parts - Remote Control

Projector remote control



- 1 ⏻ power button
- 2 🎨 color mode button



- 3  keystone button (corrects image distortion)
- 4 Arrow buttons
- 5 Enter button (selects options)
- 6  home button (displays and closes the Home screen)
- 7  return button (cancels/exits function)
- 8 E-Zoom  and  buttons (zooms in and out of images)
- 9  A/V mute button (turns audio and video on or off temporarily)
- 10  mute button (turns audio on or off temporarily)
- 11  volume up and  volume down buttons
- 12 **Freeze** button (pauses video temporarily while source continues to play)
- 13  menu button (accesses projector menus)
- 14  brightness button (adjusts image brightness)
- 15  Source Search button (changes active source)
- 16 Remote control emitter

Remote control for Android TV

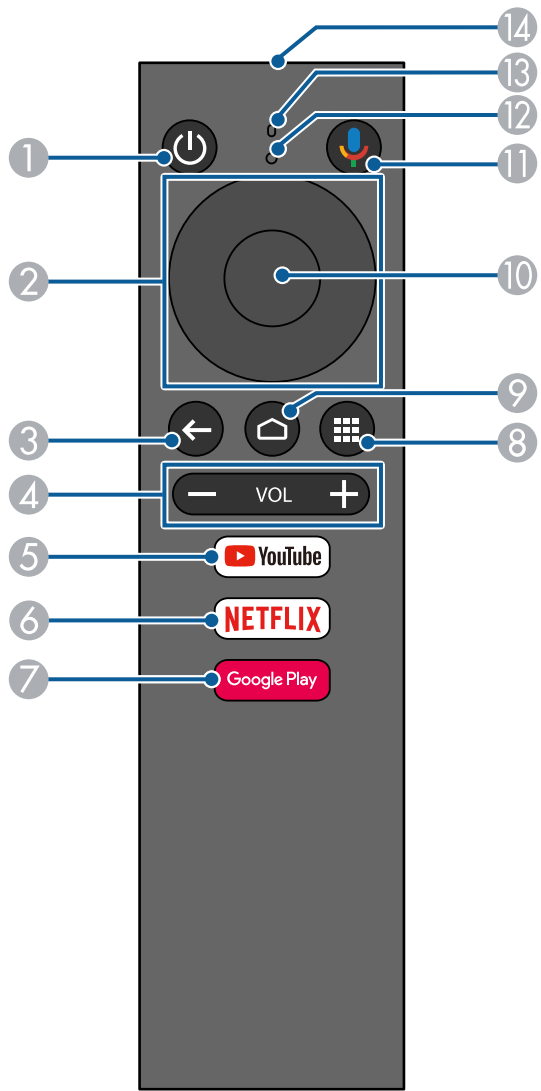
Note: The remote control for Android TV is required to use the Google Assistant voice control feature and to adjust the output volume of the streaming media player. The projector volume is adjusted independently from the audio output of the streaming media player. All other features can be controlled using the projector remote.



- 1 ⏻ power button
- 2 Arrow buttons
- 3 ⬅️ esc button

- 4 Volume buttons
- 5 **YouTube** button
- 6 **Netflix** button
- 7 **Google Play** button
- 8  apps button
- 9  home button
- 10 Enter button
- 11  mic button (operates Android TV using voice commands)
- 12 Command indicator
- 13 Microphone
- 14 Remote control emitter

Parent topic: [Projector Part Locations](#)

Setting Up the Projector

Follow the instructions in these sections to set up your projector for use.

[Projector Placement](#)

[Projector Connections](#)

[Installing Batteries in the Remote Control](#)

[Setting Up Android TV](#)

Projector Placement

You can place the projector on almost any flat surface to project an image.

Keep these considerations in mind as you select a projector location:

- Place the projector on a sturdy, level surface.
- Do not place or install the projector vertically.
- Leave plenty of space around and under the projector for ventilation, and do not place it on top of or next to anything that could block the vents.
- Wherever you set up the projector, make sure to position it squarely in front of the center of the screen, not at an angle, if possible.
- Position the projector within reach of a grounded electrical outlet or extension cord.

[Projector Setup and Installation Options](#)

[Projection Distance](#)

Parent topic: [Setting Up the Projector](#)

Related references

[Important Safety Information](#)

[Important Safety Instructions](#)

Projector Setup and Installation Options

You can set up or install your projector in the following ways:

Front

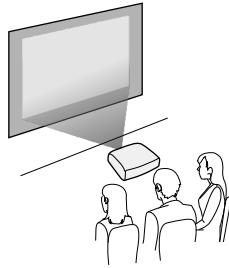

Rear

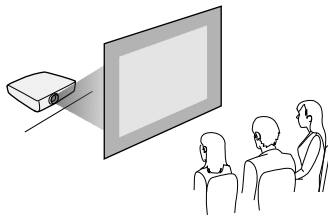

Wherever you set up the projector, make sure to position it squarely in front of the center of the screen, not at an angle, if possible.

If you project from the rear, be sure to select the correct **Projection** option in the projector's Settings menu.

Installation space

Be sure to leave the following amount of space around the projector so as to not block the air exhaust or intake vents.

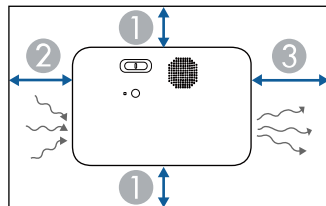

- 1 3.94 inches (10 cm)
- 2 7.87 inches (20 cm)
- 3 11.81 inches (30 cm)

Parent topic: [Projector Placement](#)

Related tasks

[Changing the Projection Mode Using the Menus](#)

Projection Distance

The distance at which you place the projector from the screen determines the approximate size of the image. The image size increases the farther the projector is from the screen, but can vary depending on the zoom factor, aspect ratio, and other settings.

Use the tables here to determine approximately how far to place the projector from the screen based on the size of the projected image. (Conversion figures may have been rounded up or down.) You can also use the Projection Distance Calculator [here](#) (U.S.), [here](#) (Canada), or [here](#) (Caribbean).

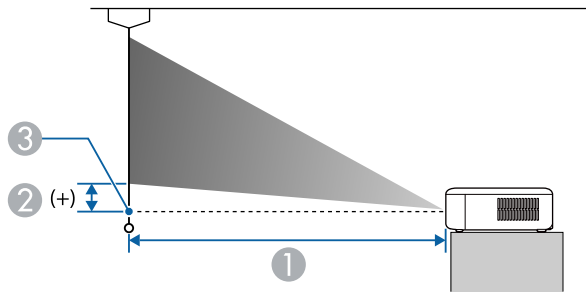

- 1 Projection distance
- 2 Distance from the center of the lens to the base of the screen
- 3 Center of lens

16:9 Aspect Ratio Image or Screen		
Screen or image size	Projection distance (1) Wide to Tele	Distance from center of lens to base of screen (2)
26 inches	26 to 36 inches (67 to 91 cm)	-1.6 to 0 inches (-4 to 0 cm)
34 inches	35 to 47 inches (89 to 120 cm)	-2 to 0.4 inches (-5 to 1 cm)
40 inches	41 to 56 inches (105 to 142 cm)	-2.3 to 0.4 inches (-6 to 1 cm)
60 inches	62 to 84 inches (158 to 214 cm)	-3.5 to 0.4 inches (-9 to 1 cm)
80 inches	83 to 113 inches (211 to 286 cm)	-4.7 to 0.4 inches (-12 to 1 cm)
100 inches	104 to 141 inches (264 to 358 cm)	-5.9 to 0.8 inches (-15 to 2 cm)
200 inches	209 to 282 inches (531 to 717 cm)	-11.8 to 1.6 inches (-30 to 4 cm)
290 inches	304 to 410 inches (771 to 1041 cm)	-17 to 2 inches (-43 to 5 cm)
300 inches	314 to 424 inches (797 to 1077 cm)	-17.3 to 2.3 inches (-44 to 6 cm)
391 inches	409 to 553 inches (1040 to 1404 cm)	-23 to 2.8 inches (-58 to 7 cm)

16:10 Aspect Ratio Image or Screen		
Screen or image size	Projection distance (1) Wide to Tele	Distance from center of lens to base of screen (2)
24 inches	26 to 36 inches (67 to 91 cm)	-1.6 to 0 inches (-4 to 0 cm)
32 inches	35 to 48 inches (90 to 122 cm)	-2 to 0.4 inches (-5 to 1 cm)
40 inches	44 to 61 inches (113 to 154 cm)	-2.4 to 0.4 inches (-6 to 1 cm)
60 inches	67 to 91 inches (171 to 231 cm)	-3.9 to 0.4 inches (-10 to 1 cm)
80 inches	90 to 122 inches (228 to 309 cm)	-5.1 to 0.8 inches (-13 to 2 cm)
100 inches	113 to 152 inches (286 to 387 cm)	-6.3 to 0.8 inches (-16 to 2 cm)
150 inches	169 to 229 inches (430 to 581 cm)	-9.4 to 1.2 inches (-24 to 3 cm)
200 inches	226 to 306 inches (574 to 776 cm)	-12.6 to 1.6 inches (-32 to 4 cm)
268 inches	303 to 409 inches (770 to 1040 cm)	-17 to 2 inches (-43 to 5 cm)
300 inches	339 to 459 inches (862 to 1165 cm)	-18.9 to 2.4 inches (-48 to 6 cm)
362 inches	410 to 554 inches (1041 to 1406 cm)	-22.8 to 2.8 inches (-58 to 7 cm)

4:3 Aspect Ratio Image or Screen		
Screen or image size	Projection distance (1) Wide to Tele	Distance from center of lens to base of screen (2)
21 inches	26 to 36 inches (66 to 91 cm)	-1.6 to 0 inches (-4 to 0 cm)
28 inches	35 to 48 inches (89 to 121 cm)	-2 to 0.4 inches (-5 to 1 cm)
40 inches	50 to 69 inches (128 to 174 cm)	-2.8 to 0.4 inches (-7 to 1 cm)
60 inches	76 to 103 inches (194 to 262 cm)	-4.3 to 0.4 inches (-11 to 1 cm)
80 inches	102 to 138 inches (259 to 350 cm)	-5.5 to 0.8 inches (-14 to 2 cm)
100 inches	128 to 172 inches (324 to 438 cm)	-7.1 to 0.8 inches (-18 to 2 cm)
150 inches	192 to 259 inches (487 to 658 cm)	-10.6 to 1.2 inches (-27 to 3 cm)
200 inches	256 to 346 inches (650 to 878 cm)	-14.2 to 1.6 inches (-36 to 4 cm)
237 inches	304 to 410 inches (771 to 1041 cm)	-17 to 2 inches (-43 to 5 cm)
300 inches	384 to 519 inches (976 to 1319 cm)	-21.3 to 2.8 inches (-54 to 7 cm)
320 inches	410 to 554 inches (1042 to 1407 cm)	-22.8 to 2.8 inches (-58 to 7 cm)

Parent topic: [Projector Placement](#)

Projector Connections

See these sections to connect the projector to a variety of projection sources.

Caution: If you will use the projector at altitudes above 4921 feet (1500 m), turn on **High Altitude Mode** to ensure the projector's internal temperature is regulated properly.

Caution: Check the shape and orientation of the connectors on any cable you plan to connect. Do not force a connector into a port if it does not fit. The device or your projector could be damaged or could malfunction.

Caution: Depending on the connected device and the shape of the cable, you may not be able to attach the projector's side cover. Do not force the cover into place or the device or the projector could be damaged or could malfunction.

[Connecting to an HDMI Video Source](#)

[Connecting to a Streaming Media Player](#)

[Connecting to a Bluetooth Audio Device](#)

Parent topic: [Setting Up the Projector](#)

Related references

[Projector Feature Settings - Settings Menu](#)

Connecting to an HDMI Video Source

If your video source has an HDMI port, you can connect it to the projector using an optional HDMI cable. The HDMI connection provides the best image quality.

Caution: Do not turn on the video source before connecting it to the projector. Doing so could damage the projector.

1. Connect the HDMI cable to your video source's HDMI output port.

2. Connect the other end to the projector's **HDMI** port.

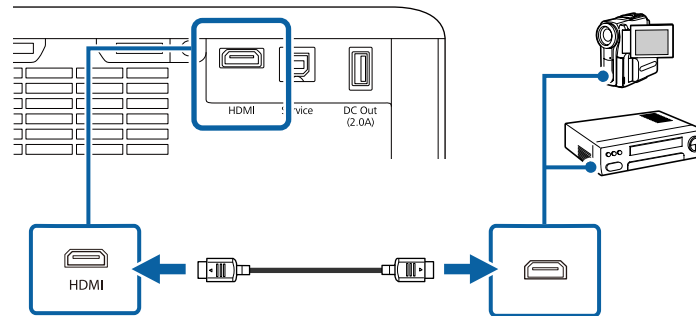

Note: When an audio/video source that meets the HDMI CEC standard is connected to the projector's HDMI port, you can use the projector's remote control to control certain features of the linked device by accessing the **Settings > Operation** menu and enabling the **HDMI Link** setting.

Parent topic: [Projector Connections](#)

Related references

[Projector Feature Settings - Settings Menu](#)

Related tasks

[Operating Connected Devices Using the HDMI Link Features](#)

Connecting to a Streaming Media Player

You can connect the Epson streaming media player for Android TV to the projector's HDMI port. You can power the streaming media player from the projector by connecting the USB power cable to the appropriate port.

1. Remove the side cover by pressing the tab and sliding the cover towards the rear of the projector.

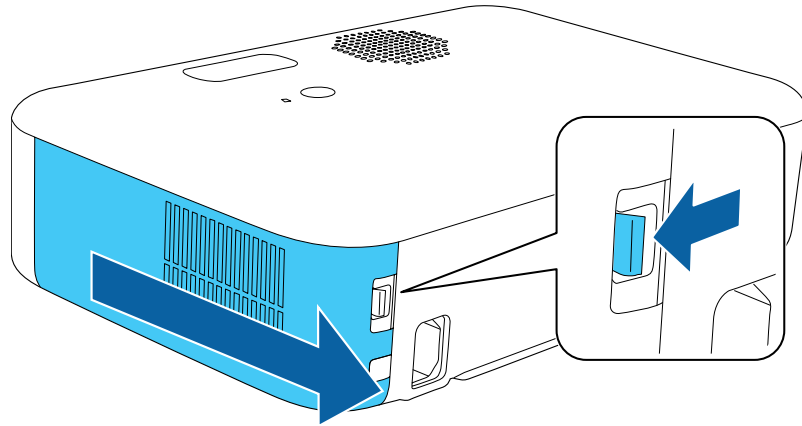

2. Connect the HDMI extension cable to the **HDMI** port and the USB power cable to the **DC Out** port.

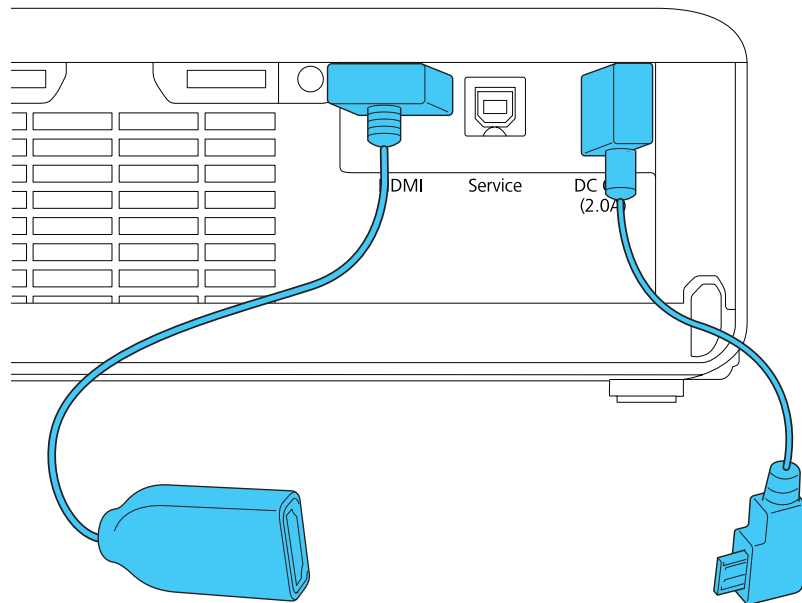

3. Connect the HDMI extension cable and USB power cable to the streaming media player and fit it into the port compartment.

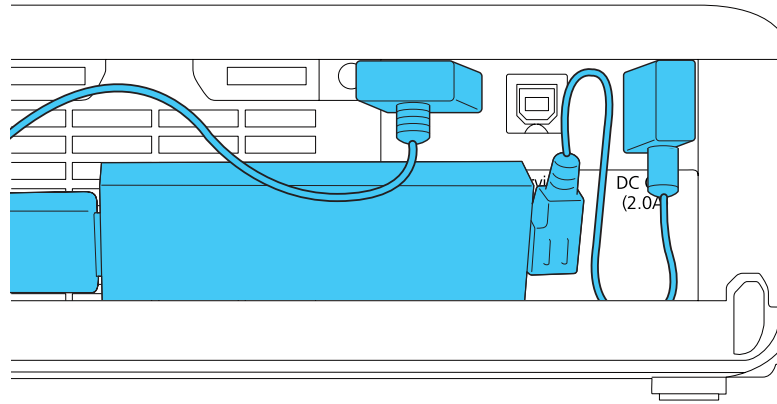

4. Replace the side cover. The tab clicks into place when the cover is fully closed.

Parent topic: [Projector Connections](#)

Related tasks

[Using the Home Screen](#)

[Setting Up Android TV](#)

Connecting to a Bluetooth Audio Device

You can use the streaming media player to connect your projector to Bluetooth audio devices such as speakers or headphones.

Note: There may be a slight delay in audio output. Bluetooth audio devices are not supported in some countries and regions.

Note: When a Bluetooth audio device is paired to the projector, the built-in speaker system is disabled.

1. Turn on the projector.
2. Select the  icon at the top right of the Android TV Home screen and press **Enter**.
3. Select **Remotes & Accessories** and press **Enter**.
4. Select **Add Accessory**.

The projector searches for compatible Bluetooth devices.

5. Turn on your device and start the pairing process on it. See the documentation supplied with the device for more information.

Compatible devices are displayed on-screen when discovered by the projector.

6. Select the device you want to connect to and press **Enter**.
7. Follow the on-screen instructions to complete pairing.
8. Press the ↶ return button to exit the menus.

Parent topic: [Projector Connections](#)

Installing Batteries in the Remote Control

The remote control uses the two AAA batteries that came with the projector.

Caution: Use only the type of batteries specified in this manual. Do not install batteries of different types, or mix new and old batteries.

1. Remove the battery cover.

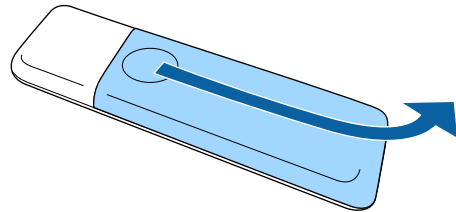

2. Insert the batteries with the + and – ends facing as shown.

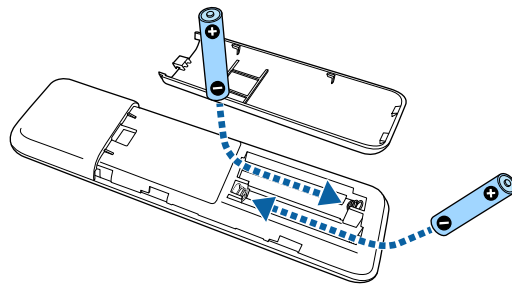

Warning: Make sure the batteries are inserted in the correct positions. If the batteries are not inserted correctly, they could explode or leak, causing a fire, injury, or damage to the product.

3. Replace the battery cover and press it down until it clicks into place.

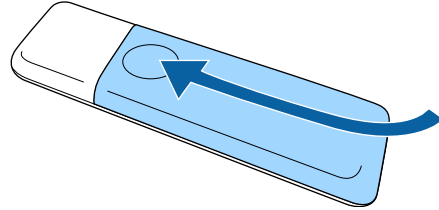



Warning: Dispose of used batteries according to local regulations. Do not expose batteries to heat or flame. Keep batteries out of the reach of children; they are choking hazards and are very dangerous if swallowed.

Parent topic: [Setting Up the Projector](#)

Setting Up Android TV

Android TV must be set-up when you turn on the projector for the first time.

Note: After initial setup, you can change the settings by selecting the  icon at the top right of the Android TV Home screen.

1. Press the  power button on the projector or remote control.
2. If you have not connected the streaming media player, you see a screen prompting you to connect it.

3. When the pairing screen is displayed, press and hold the Enter and  volume down remote control buttons at the same time.

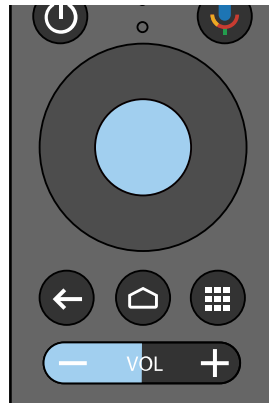

The light on the remote control flashes until pairing is complete.

4. Use the arrow and **Enter** buttons to select the language you want to use from the language selection screen.
5. When the Wi-Fi setting screen is displayed, select the wireless network you want to use and then follow the on-screen instructions to make any necessary settings.
6. At the Google account sign-in screen, do one of the following:
 - Select **Sign In** to sign-in to your Google account. Follow the on-screen instructions.
 - Select **Skip** to use the projector without signing in to a Google account

Note: A Google account is required to use certain features.

7. Follow the on-screen instructions to proceed with initial setup, selecting settings as desired.
The Home screen is displayed when initial setup is completed.

Note: For Android TV support, visit <https://support.google.com/androidtv/>.

Parent topic: [Setting Up the Projector](#)

Related tasks

[Using the Home Screen](#)

Using Basic Projector Features

Follow the instructions in these sections to use your projector's basic features.

[Turning On the Projector](#)

[Turning Off the Projector](#)

[Pairing the Remote Control](#)

[Remote Control Operation](#)

[Selecting the Language for the Projector Menus](#)

[Projection Modes](#)

[Adjusting the Image Height](#)

[Adjusting the Image Position Using Image Shift](#)

[Image Aspect Ratio](#)

[Image Shape](#)

[Focusing the Image Using the Focus Lever](#)

[Resizing the Image Using Zoom](#)

[Displaying a Test Pattern](#)

[Color Mode](#)

[Adjusting Picture Quality in Detail](#)

[Using Voice Commands to Control Your Projector](#)

[Using Your Projector as a Chromecast](#)

[Controlling the Volume with the Volume Buttons](#)

Turning On the Projector

Turn on the projector before you turn on the video source you want to use.

Caution: Do not turn on the video source before connecting it to the projector; otherwise, you may damage the projector.

1. Connect the power cord to the projector's power inlet and plug it in to an electrical outlet.

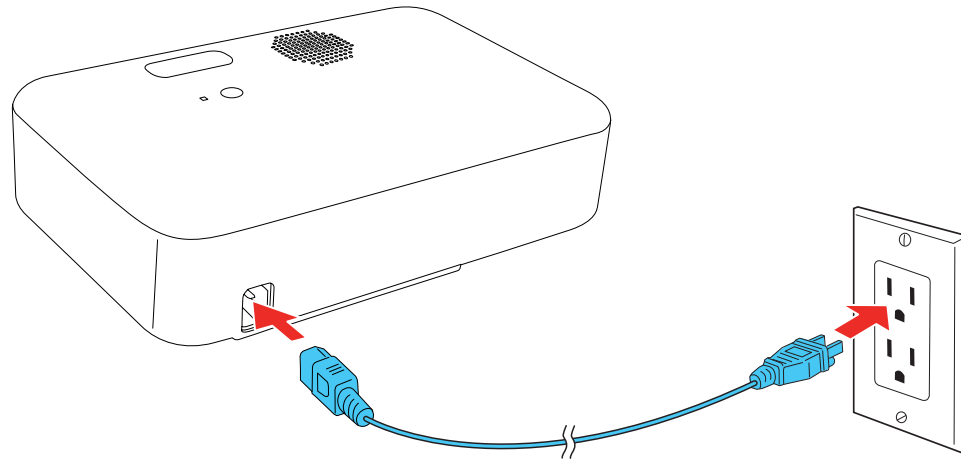

2. Press the  power button on the projector or the remote control to turn on the projector.
The status indicator flashes blue as the projector warms up. After the projector is warmed up, the status light stops flashing and turns blue.

Warning: Never look into the projector lens when the light is on. The light can damage your eyes and is especially dangerous for children and pets.

Caution: Make sure no objects are blocking the light from the projector lens. Objects blocking the lens for an extended time can melt and light that is reflected back into the lens can cause the projector to malfunction.

When the **Direct Power On** setting is enabled in the Settings menu, the projector turns on as soon as you plug it in. The projector also turns on automatically when power is restored after a power outage.

If you select a specific port as the **Auto Power On** setting in the Settings menu, the projector turns on as soon as it detects a signal or cable connection from that port.

The first time you turn on the projector, the remote control pairing screen and initial setup screen are displayed. Follow the on-screen instructions to complete the initial setup.

[Using the Home Screen](#)

Parent topic: [Using Basic Projector Features](#)

Related references

[Projector Feature Settings - Settings Menu](#)

Related tasks

[Pairing the Remote Control](#)

Using the Home Screen

You can easily access online content, applications, and projector settings from the Android TV home screen.

1. To display the Home screen, press the  Home button on the remote control.
2. Press the arrow buttons on the remote control to navigate the screen, and press **Enter** to select an option.

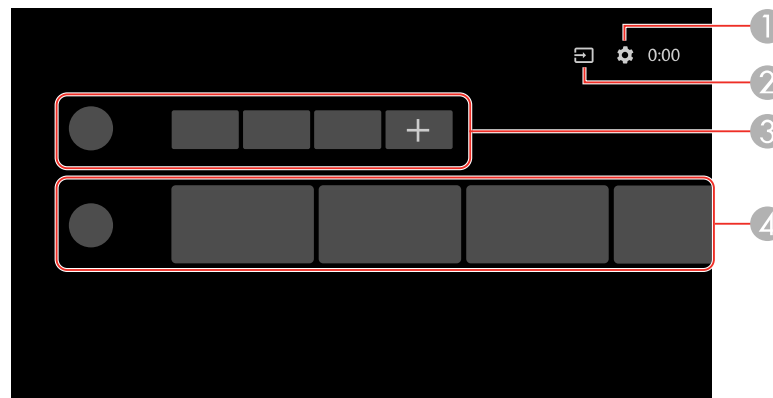

- 1 Displays the Settings menu for Android TV (you can select various settings such as Wi-Fi, language, and Google account information)
- 2 Displays a list of available input sources
- 3 Displays the applications downloaded to your Android TV (add applications to this list by selecting the + icon)
- 4 Displays recommended content from your applications

Note: The content of the Home screen may change depending on the Android TV version.

Parent topic: [Turning On the Projector](#)

Related references

[Projector Feature Settings - Settings Menu](#)

Related tasks

[Pairing the Remote Control](#)

Turning Off the Projector

Before turning off the projector, shut down any computer connected to it so you can see the computer display during shutdown.

Note: Turn off this product when not in use to prolong the life of the projector. Lamp life will vary depending upon mode selected, environmental conditions, and usage. Brightness decreases over time.

Note: When using the A/V Mute feature, the projector lamp is still on. To turn off the lamp, turn off the projector.

Note: If the streaming media player's USB power cable is connected to the projector's USB-A port, the streaming media player will turn off when the projector is turned off. It will restart when the projector is turned on again. If the streaming media player is connected to an external power source, use the power button on the streaming remote control to turn the device off and on.

1. Press the power button on the projector or the remote control.

The projector displays a shutdown confirmation screen.



2. Press the power button again. (To leave it on, press any other button.)

The lamp turns off and the status light turns off.

Note: With Epson's Instant Off technology, there is no cool-down period so you can pack up the projector for transport right away (if necessary).

Caution: Do not turn the projector on immediately after turning it off. Turning the projector on and off frequently may shorten the life of the lamp.

3. To transport or store the projector, make sure the status light is off, then unplug the power cord and any other connected devices or cables.

Caution: To avoid damaging the projector or lamp, never unplug the power cord when the status light is on or flashing.

Parent topic: [Using Basic Projector Features](#)

Pairing the Remote Control

To use Android TV and video-on-demand features, you must pair the remote control to the projector.

Note: When you first turn on the projector, instructions for pairing the remote control are displayed on the screen.

1. Turn on the projector.
2. When the pairing screen is displayed, press and hold the  volume down and **Enter** buttons on the remote control until the indicator starts blinking.

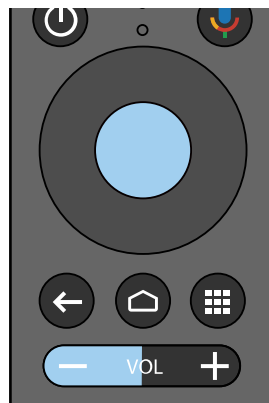

A message appears on the screen and the indicator stops blinking when the remote control is paired.

Parent topic: [Using Basic Projector Features](#)

Remote Control Operation

The remote control lets you control the projector from almost anywhere in the room, up to 19.7 feet (6 m) away.

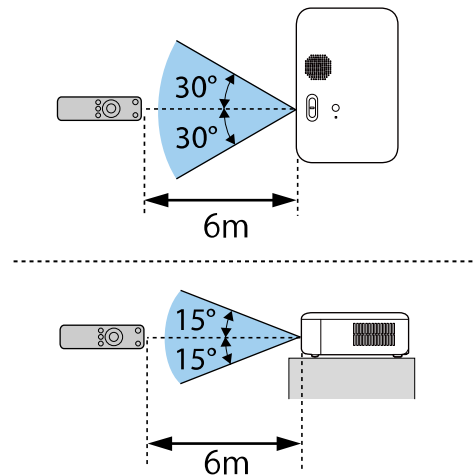



Note: Avoid using the remote control in conditions with bright fluorescent lights or in direct sunlight, or the projector may not respond to commands. If you will not use the remote control for a long time, remove the batteries.

Parent topic: [Using Basic Projector Features](#)

Selecting the Language for the Projector Menus

If you want to view the projector's menus and messages in another language, you can change the Language setting.

1. Turn on the projector.
2. Press the  menu button on the projector remote control.
3. Use the arrow buttons to select the **Settings** menu and press the **Enter** button.

4. Select the **Language** setting and press **Enter**.
5. Select the language you want to use and press **Enter**.
6. Press the  menu button to exit the menu or the  return button to return to the previous screen.

Parent topic: [Using Basic Projector Features](#)

Related references

[Projector Feature Settings - Settings Menu](#)

Projection Modes

Depending on how you positioned the projector, you may need to change the projection mode so your images project correctly.

- **Front** (default setting) lets you project from a table in front of the screen.
- **Front/Upside Down** flips the image over top-to-bottom to project upside-down from a ceiling or wall mount.
- **Rear** flips the image horizontally to project from behind a translucent screen.
- **Rear/Upside Down** flips the image over top-to-bottom and horizontally to project from the ceiling and behind a translucent screen.

Note: Your projector is not compatible with ceiling or wall mounts.

Note: You can change the projection mode using the remote control or by changing the **Projection** setting in the Settings > Installation menu.

[Changing the Projection Mode Using the Menus](#)



Parent topic: [Using Basic Projector Features](#)

Changing the Projection Mode Using the Menus

You can change the projection mode to flip the image over top-to-bottom and/or left-to-right using the projector menus.

Note: You can also press and hold the  A/V mute button on the projector remote control for about 6 seconds to flip the image upside-down.

1. Turn on the projector and display an image.
2. Press the  menu button on the projector remote control.

3. Press the arrow buttons to select the **Settings > Installation > Projection** setting and press **Enter**.
4. Select the projection mode you want to use and press **Enter**.
5. Press the  menu button to exit the menu or the  return button to return to the previous screen.

Parent topic: [Projection Modes](#)

Related references

[Projector Feature Settings - Settings Menu](#)

Adjusting the Image Height

If you are projecting from a table or other flat surface and the image is too high or low, you can adjust the image height using the projector's adjustable foot.

1. Turn on the projector and display an image.
2. Press and hold the foot release lever to extend or retract the front adjustable foot.

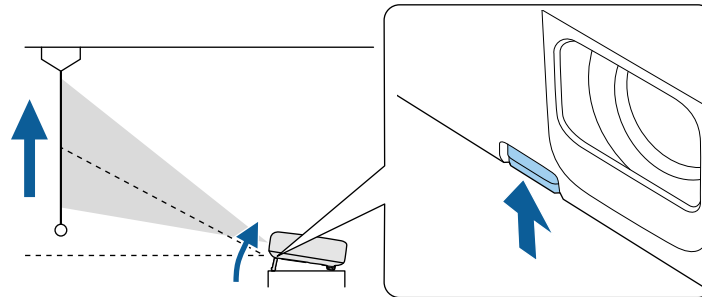

Note: You can adjust the position up to 12°.

3. Release the lever to lock the foot when the image is at the position you want.
- If the projected image is unevenly rectangular, you need to adjust the image shape.

Parent topic: [Using Basic Projector Features](#)

Related references

[Projector Feature Settings - Settings Menu](#)

Related tasks

[Correcting Image Shape with H/V Keystone](#)

[Correcting Image Shape with Quick Corner](#)

Adjusting the Image Position Using Image Shift

You can use the Image Shift feature to adjust the image position without moving the projector.

Note: This feature is not available if the digital zoom is set to the widest setting.

1. Turn on the projector and display an image.
2. Press the  menu button.
3. Select **Settings** > **Installation** > **Image Shift** to display the Image Shift screen.

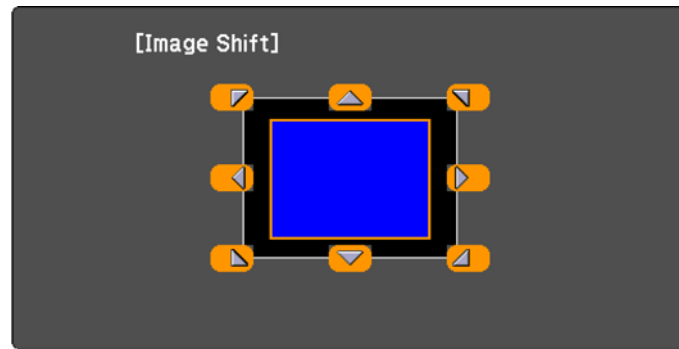

4. Use the arrow buttons on the remote control to adjust the image position.

Note: You can shift the image diagonally by pressing any pair of adjacent arrow buttons on the remote control.

5. Press  return to close the Image Shift screen.

Note: The Image Shift setting is retained even if the projector is turned off; however, you need to readjust the image position if you change the projector's location or angle.

Parent topic: [Using Basic Projector Features](#)

Related references

[Projector Feature Settings - Settings Menu](#)

Image Aspect Ratio

The projector can display images in different width-to-height ratios called aspect ratios. Normally the input signal from your video source determines the image's aspect ratio setting. However, for certain images you can change the aspect ratio to fit your screen.



If you always want to use a particular aspect ratio for a certain video input source, you can select it using the projector's menus.

[Changing the Image Aspect Ratio](#)

[Available Image Aspect Ratios](#)

Parent topic: [Using Basic Projector Features](#)

Changing the Image Aspect Ratio

1. Turn on the projector and switch to the image source you want to use.
2. Press the  menu button on the projector remote control.
3. Select the **Image** menu and press **Enter**.
4. Select **Aspect** and press **Enter**.
5. Select the aspect ratio you want to use for your input signal and press **Enter**.
6. Press the  menu button or the  return button to exit the menus.

Parent topic: [Image Aspect Ratio](#)

Related references

[Image Quality Settings - Image Menu](#)

Available Image Aspect Ratios

You can select the following image aspect ratio settings, depending on the input signal from your image source.

Note: Using the aspect ratio function to reduce, enlarge, or split the projected image for commercial purposes or for public viewing may infringe upon the rights of the copyright holder of that image based on copyright law.

Aspect ratio setting	Description
Auto	Automatically sets the aspect ratio according to the input signal.

Aspect ratio setting	Description
Full	Displays images using the full width of the projection area, but does not maintain the aspect ratio.
Zoom	Displays images using the full width of the projection area and maintains the aspect ratio of the image.
Native	Displays images as is (aspect ratio and resolution are maintained).

Parent topic: [Image Aspect Ratio](#)

Image Shape

You can project an evenly rectangular image by placing the projector directly in front of the center of the screen and keeping it level. If you place the projector at an angle to the screen, or tilted up or down, or off to the side, you may need to correct the image shape for the best display quality.

When you turn on automatic keystone correction in your projector's Settings menu, your projector automatically corrects vertical keystone effects when you reposition the projector.

[Correcting Image Shape with H/V Keystone](#)

[Correcting Image Shape with Quick Corner](#)

Parent topic: [Using Basic Projector Features](#)

Related references

[Projector Feature Settings - Settings Menu](#)

Correcting Image Shape with H/V Keystone

You can use the projector remote control to correct the shape of an image that is unevenly rectangular on the sides.

Note: You can also adjust the keystone settings from the **Settings > Installation > Keystone > H/V Keystone** menu.

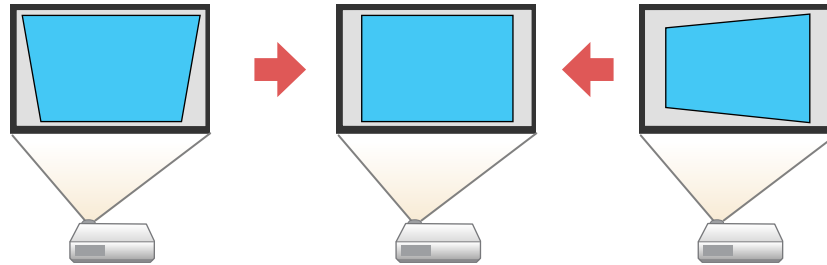

Note: You cannot combine **Keystone** correction with other image shape correction methods.

1. Turn on the projector and display an image.
2. Press the  keystone button on the projector remote control.
3. Use the arrow buttons on the projector remote control to select between vertical and horizontal keystone correction, and to adjust the image shape as necessary.

V-Keystone

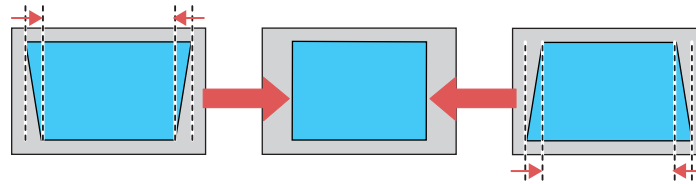

H-Keystone

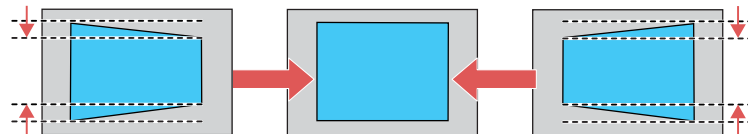

4. Press the ↶ return button when you are finished.
After correction, your image is slightly smaller.

Parent topic: [Image Shape](#)

Related references

[Projector Feature Settings - Settings Menu](#)

Correcting Image Shape with Quick Corner

You can use the projector's Quick Corner setting to correct the shape and size of an image that is unevenly rectangular on all sides.

1. Turn on the projector and display an image.
2. Press the  menu button.
3. Select the **Settings > Installation** menu and press **Enter**.
4. Select the **Keystone** setting and press **Enter**.
5. Select the **Quick Corner** setting and press **Enter**.

Note: You may see a confirmation screen. Select **Yes** and press **Enter** again.

Note: You can also press the  keystone button on the remote control to display the Keystone adjustment screen.

You see the Quick Corner adjustment screen:

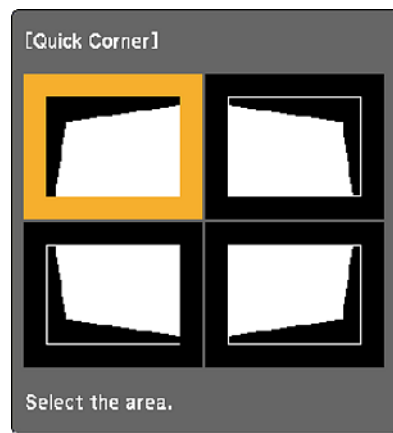

6. Use the arrow buttons on the remote control to select the corner of the image you want to adjust. Then press **Enter**.

Note: To reset your adjustments, press and hold the ↩ return button for at least 2 seconds to display a reset screen. Then select **Yes**.

7. Press the arrow buttons to adjust the image shape as necessary. Press **Enter** to return to the area selection screen.

Note: If one of the directional arrows on the screen turns gray, you cannot adjust the shape any further in that direction.

8. When you are finished, press the ↩ return button.

Parent topic: [Image Shape](#)

Related references

[Projector Feature Settings - Settings Menu](#)

Focusing the Image Using the Focus Lever

You can adjust the sharpness of the projected image using the focus lever on the projector.

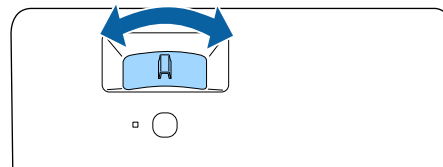
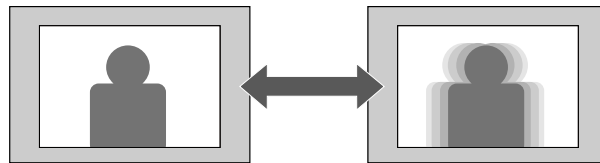

1. Turn on the projector and display an image.
2. Move the lever left or right to adjust the focus.



Parent topic: [Using Basic Projector Features](#)

Resizing the Image Using Zoom

You can resize the displayed image.

1. Turn on the projector and display an image.
2. Press the  menu button on the projector remote control.
3. Press the arrow buttons to select the **Settings** menu and press **Enter**.
4. Select the **Installation** setting and press **Enter**.
5. Select the **Zoom** setting and press **Enter**.
6. Press the left or right arrow button to adjust the zoom setting between **Wide** and **Tele**.
7. Press the  menu button to exit the menu or the  return button to return to the previous screen.

Parent topic: [Using Basic Projector Features](#)



Related references

[Projector Feature Settings - Settings Menu](#)

Displaying a Test Pattern

You can display a test pattern to adjust the projected image without connecting a computer or video device.

Note: Some menu options may be unavailable when displaying a test pattern and you may need to project from a connected device to change these settings.

1. Turn on the projector.
2. Press the  menu button on the remote control.
3. Select the **Settings** menu and press **Enter**.
4. Select the **Installation > Pattern** setting and press **Enter**.
5. Select **Pattern Type** to choose a pattern. You can choose one of the provided patterns or a user-created pattern.
6. Select **Pattern Display** to display the selected pattern.
7. Adjust the image as necessary.
8. Press  return to clear the test pattern.

Parent topic: [Using Basic Projector Features](#)

Related references

[Projector Feature Settings - Settings Menu](#)

Color Mode

The projector offers different Color Modes to provide optimum brightness, contrast, and color for a variety of viewing environments and image types. You can select a mode designed to match your image and environment, or experiment with the available modes.

[Changing the Color Mode](#)



[Available Color Modes](#)

Parent topic: [Using Basic Projector Features](#)

Changing the Color Mode

You can change the projector's Color Mode using the remote control to optimize the image for your viewing environment.

Note: You can also change the Color Mode in the projector's Image menu.

1. Turn on the projector and switch to the image source you want to use.
2. Press the  color mode button on the remote control to change the Color Mode.
The image appearance changes and the name of the Color Mode appears briefly on the screen.
3. To cycle through all the available Color Modes for your input signal, press the  color mode button repeatedly.

Parent topic: [Color Mode](#)

Related references

[Image Quality Settings - Image Menu](#)

Available Color Modes

You can set the projector to use these Color Modes, depending on the input source you are using:

Color Mode	Description
Dynamic	Best for optimizing brightness
Vivid	Best for projecting general content in a bright environment

Color Mode	Description
Cinema	Best for projecting movies in a dark environment
Natural	Best for projecting the image as is (choose this mode when making color adjustments)

Parent topic: [Color Mode](#)

Adjusting Picture Quality in Detail

You can fine-tune the image details using the projector menus.

1. Turn on the projector and switch to the image source you want to use.
2. Press the  menu button on the remote control.
3. Select the **Image** menu and press **Enter**.
4. Select the **Expert Settings** setting and press **Enter**.
5. To adjust the overall color brightness, select **Brightness** and adjust the following settings.
 - **Brightness**: Adjusts overall color brightness
 - **Contrast**: Adjusts the difference between light and dark areas of the image
 - **Scene Adaptive Gamma**: Adjusts the coloring according to the scene to present a more vivid image. Larger numbers increase contrast.

Note: The **Brightness** setting does not affect lamp brightness. To change the lamp brightness, adjust the **Image > Light Output** setting.

6. To adjust the intensity of the image colors, select **Color** and adjust the following settings.
 - **Color Saturation**: Adjusts the overall color density
 - **Tint**: Adjusts the balance of green and magenta in the image
 - **White Balance: Color Temp**: Sets the color temperature according to the color mode you selected. Higher values tint the image blue, while lower numbers tint the image red. To adjust individual RGB offset and gain, select **Customized**.
7. To adjust the overall sharpness of the image, select **Sharpness** and adjust the values.
8. Press the  return button to exit the menus.

Parent topic: [Using Basic Projector Features](#)

Related references

[Image Quality Settings - Image Menu](#)

Using Voice Commands to Control Your Projector

You can use your remote control or linked Google Home device to control your projector using voice commands.

Note: You will need to use the streaming media player remote to use the voice control feature. Make sure the remote control is paired to the projector.

1. To use voice commands with your projector using your remote, press and release the  mic button, then say the command you want to perform.

You can use voice commands to search for actors or shows, open installed apps, and control media playback.

2. To use a Google Home device to send voice commands to your projector, link the device with your projector using the Google Home app. You may also need to link streaming apps to your Google account. For detailed instructions, go to your device's support page.

Parent topic: [Using Basic Projector Features](#)

Using Your Projector as a Chromecast

The streaming media player has Chromecast built-in, allowing you to cast content from Chromecast-enabled apps.

1. Connect your device or computer to the same wireless network as the streaming media player.
2. Open the Chromecast-enabled app and press the  Cast button.
3. Select the streaming media player from the list of devices.

Note: By default, the name of the streaming media player is ELPAP12. To select another name or use a custom name, select the  Settings icon on the Home screen.



The app connects and starts casting to the projector.

4. To stop casting, press the  Cast button in the app and choose the disconnect option.

Parent topic: [Using Basic Projector Features](#)

Controlling the Volume with the Volume Buttons

You must adjust the volume separately for each connected input source.

1. Turn on the projector and start a presentation that includes audio.
2. To raise or lower the volume, press the  volume up or  volume down button on the projector remote control.
3. To set the volume to a specific level for an input source, use the projector menus.

Parent topic: [Using Basic Projector Features](#)

Adjusting Projector Features

Follow the instructions in these sections to use your projector's feature adjustments.

[Operating Connected Devices Using the HDMI Link Features](#)

[Shutting Off the Picture and Sound Temporarily](#)

[Zooming Into and Out of Images](#)



[Projector Security Features](#)

[Copying Menu Settings Between Projectors](#)

Operating Connected Devices Using the HDMI Link Features

You can use the projector remote control to control certain features of devices connected to the projector's HDMI port.



Note: The connected device and HDMI cable must meet the HDMI CEC standard. The device must also be configured; see the documentation that came with the device. All devices or functions may not operate properly.

1. Press the  menu button on the projector remote control.
2. Press the arrow buttons to select the **Settings** menu and press **Enter**.
3. Select the **Operation** setting and press **Enter**.
4. Select the **HDMI Link** setting and press **Enter**.
5. Select the **HDMI Link** setting again and press **Enter**. Then select **On** and press the  return button.
6. Select the **Device Connections** setting and press **Enter**.

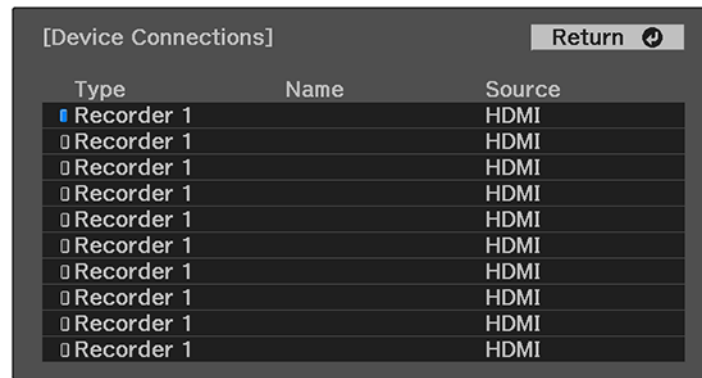
You see a screen like this:



Note: Linked devices are indicated by a blue mark. You cannot select grayed-out devices.

7. Select the device you want to control and project images from and press **Enter**.
8. Select the following HDMI Link options as necessary and press **Enter**:
 - **Audio Out Device:** select whether to play audio through the internal speaker or a connected audio/video system
 - **Power On Link:** select what happens when you turn on the projector or linked device. Select **PJ - > Device** or **Bidirectional** to turn the linked device on when the projector is turned on, or select **Device -> PJ** or **Bidirectional** to turn the projector on when the linked device is turned on.
 - **Power Off Link:** select whether linked devices are turned off when the projector is turned off.
9. Press the  menu button to exit the menu or the  return button to return to the previous screen.

Parent topic: [Adjusting Projector Features](#)



Related references

[Solutions to HDMI Link Problems](#)

Shutting Off the Picture and Sound Temporarily

You can temporarily turn off the projector's picture and sound. Any sound or video action continues to run, however, so you cannot resume projection at the point that you stopped it.

1. Press the  A/V mute button on the projector remote control to temporarily stop projection and mute any sound.

2. To turn the picture and sound back on, press the  A/V mute button again.
3. To mute the sound only, press the  mute button.
4. To pause or resume projection, press the **Freeze** button.





While the Freeze and/or Mute features are active, projection continues in the background.

Parent topic: [Adjusting Projector Features](#)

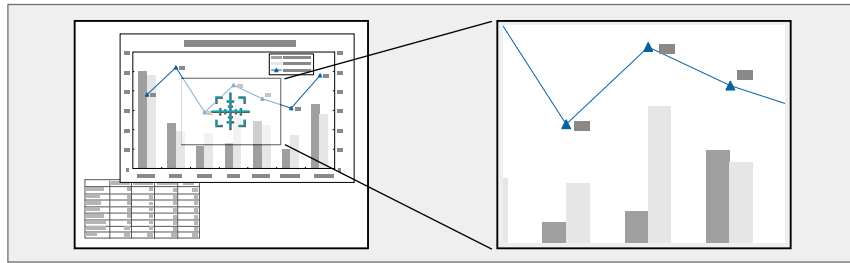
Zooming Into and Out of Images

You can draw attention to parts of a presentation by zooming into a portion of the image and enlarging it on the screen.



1. Press the  button on the remote control.
You see a crosshair on the screen indicating the center of the zoom area.
2. Use the following buttons on the remote control to adjust the zoomed image:
 - Use the arrow buttons to position the crosshair in the image area you want to zoom into.
 - Press the  button repeatedly to zoom into the image area, enlarging it as necessary. Press and hold the  button to zoom in more quickly.
 - To pan around the zoomed image area, use the arrow buttons.
 - To zoom out of the image, press the  button as necessary.
 - To return to the original image size, press the  return button.

Parent topic: [Adjusting Projector Features](#)

Projector Security Features

You can secure your projector to deter theft or prevent unintended use by setting up the following security features:

- Password security to prevent the projector from being turned on, and prevent changes to the startup screen and other settings.
- Security cabling to physically cable the projector in place.

[Password Security Types](#)

[Creating a User Pattern to Display](#)

[Installing a Security Cable](#)

Parent topic: [Adjusting Projector Features](#)

Password Security Types

You can set up these types of password security using one shared password:

- **Power On Protect** prevents anyone from using the projector without first entering a password.
- **User's Logo Protect** prevents anyone from changing the custom screen the projector can display when it turns on or when you use the A/V Mute feature. The presence of the custom screen discourages theft by identifying the projector's owner.

[Setting a Password](#)

[Selecting Password Security Types](#)

[Entering a Password to Use the Projector](#)

[Saving a User's Logo Image to Display](#)

Parent topic: [Projector Security Features](#)

Setting a Password

To use password security, you must set a password.

Note: The default password is set to **0000**.

1. Hold down the **Freeze** button on the remote control for about five seconds or until you see the **Password Protection** menu.
2. Press the down arrow to select **Password** and press **Enter**.
You see the prompt "Change the password?".
3. Select **Yes** and press **Enter**.

4. Enter a four-digit password by pressing the arrow and **Enter** buttons. To select numbers from 5 to 9, press the  menu button.

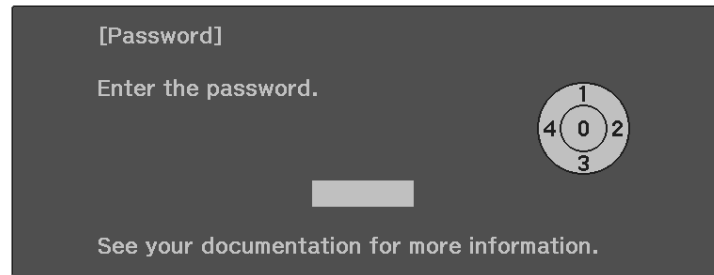

The password displays as **** as you enter it. Then you see the confirmation prompt.

5. Enter the password again.
You see the message "Password accepted."
6. Press  return to return to the menu.
7. Make a note of the password and keep it in a safe place in case you forget it.

Parent topic: [Password Security Types](#)

Selecting Password Security Types

After setting a password, you see the Password Protect menu. Select the password security types you want to use.

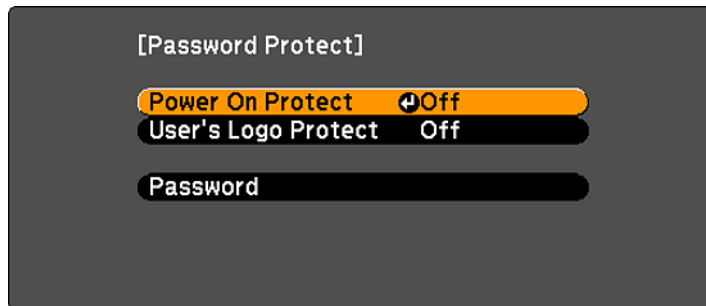

If you do not see this menu, hold down the **Freeze** button on the remote control for five seconds until the menu appears.

1. To prevent unauthorized use of the projector, select **Power On Protect** and set it to **On**.

2. To prevent changes to the User's Logo screen or related display settings, select **User's Logo Protect** and set it to **On**.

You can attach the Password Protect sticker to the projector as an additional theft deterrent.

Note: Be sure to keep the remote control in a safe place; if you lose it, you will not be able to enter the password required to use the projector.

Parent topic: [Password Security Types](#)

Entering a Password to Use the Projector

If a password is set up and a **Power On Protection** password is enabled, you see a prompt to enter a password whenever you turn on the projector.

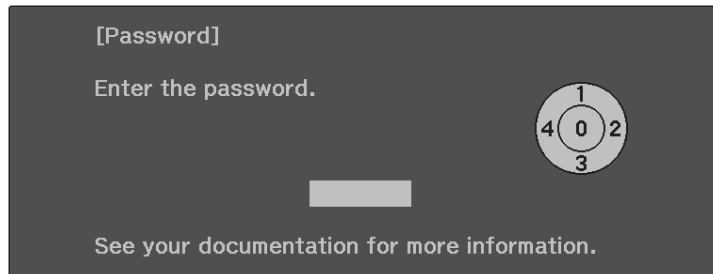

You must enter the correct password to use the projector.

1. Enter a four-digit password by pressing the arrow and **Enter** buttons. To select numbers from 5 to 9, press the  menu button.
2. If the password is incorrect, the following may happen:
 - You see a "wrong password" message and a prompt to try again. Enter the correct password to proceed.
 - If you have forgotten the password, make note of the **Request Code: xxxxx** number that appears on the screen and contact Epson Support.
 - If you enter an incorrect password five times in succession, you see a message telling you that the projector is locked. After the message is displayed for 5 minutes, the projector enters standby mode. Unplug the projector, plug in the power cord, and turn on the projector. You see a prompt to enter the password.
 - If you continue to enter an incorrect password 30 times in succession, the projector displays a request code and a message to contact Epson Support. Do not attempt to enter the password

again. When you contact Epson Support, provide the displayed request code and proof of ownership for assistance in unlocking the projector.

Parent topic: [Password Security Types](#)

Saving a User's Logo Image to Display

You can transfer an image to the projector and then display it whenever the projector turns on. You can also display the image when the projector is not receiving an input signal or when you temporarily stop projection (using the A/V Mute feature). This transferred image is called the User's Logo screen.

The image you select as the User's Logo can be a photo, graphic, or company logo, which is useful in identifying the projector's owner to help deter theft. You can prevent changes to the User's Logo by setting up password protection for it. You cannot save images that are protected by HDCP.

Note: If the User's Logo Protection setting is enabled, make sure you disable it before saving a new User's Logo.

Note: When you copy the menu settings from one projector to another using the batch setup feature, the user logo is also copied. Do not include any information in the user logo that you do not want to share between multiple projectors.

1. Display the image you want to project as the User's Logo.
2. Press the  menu button and select the **Settings > Display > User's Logo > Start Setting** setting.

Note: Adjustments such as Keystone, Zoom, or Aspect are temporarily canceled when selecting the User's Logo.

3. A prompt appears asking if you want to use the displayed image as the user's logo. Select **Yes**, then confirm your choice.

You see a completion message.

4. Press  return to select when you want to display the User's Logo screen:
 - To display it whenever you turn the projector on, select **Startup Screen** and set it to **On**.
 - To display it whenever you press the **A/V Mute** button, select **A/V Mute** and set it to **Logo**.

To prevent anyone from changing the User's Logo settings without first entering a password, set a password and enable User's Logo security.

Parent topic: [Password Security Types](#)

Creating a User Pattern to Display

You can transfer an image to the projector and then display it as a pattern to aid in presentations when you use the Pattern Display feature. This transferred image is called the User Pattern.

Note: Once you save a user pattern, you cannot restore the default pattern. You cannot save an image that is protected by HDCP. If a pattern is displayed for a long time, a residual image may be visible in projected images.

1. Display the image you want to project as the User Pattern from a connected computer or video source.
2. Press the  menu button and select the **Settings > Installation > Pattern > User Pattern** setting. You see a prompt asking if you want to use the displayed image as a User Pattern.

Note: When you select **User Pattern**, adjustments such as **Keystone**, **Zoom**, or **Aspect** are temporarily canceled.

3. Select **Yes** and then confirm your choice. You see a completion message.
4. Press **Enter** to exit the message screen.

To view your user pattern, set the **Pattern Type** setting to **User Pattern**, then select the **Pattern Display** setting.

Parent topic: [Projector Security Features](#)

Installing a Security Cable

You can use the security slot on the side of the projector to attach a Kensington lock. See your local computer or electronics dealer for purchase information.

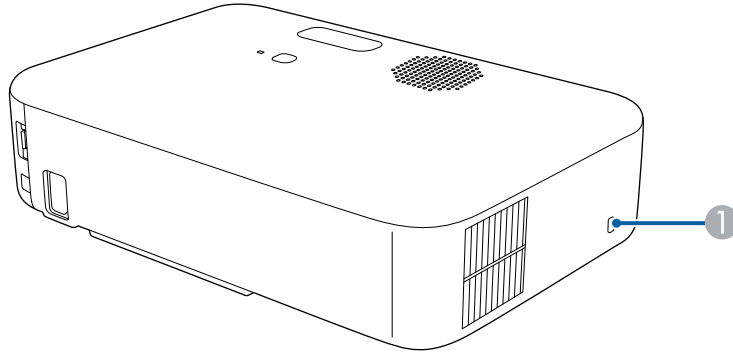

1 Security slot

Parent topic: [Projector Security Features](#)

Related references

[Projector Parts - Rear](#)

Copying Menu Settings Between Projectors

After you select menu settings for your projector, you can transfer them to another projector of the same model.

Note: Copy the projector's settings before you adjust the projected image using the projector's image adjustment settings. Any saved User's Logo setting on the projector will transfer to the other projector.

Caution: If the copy process fails due to a power failure, communication error, or for any other reason, Epson will not be responsible for any repair costs incurred.

The following settings will not transfer between projectors:

- Lamp Hours
- Status

The following settings will not transfer between projectors if you set the **Batch Setup Range** setting to **Limited**:

- Password Protection settings

[Saving Settings to a USB Flash Drive](#)

[Transferring Settings from a USB Flash Drive](#)

[Saving Settings to a Computer](#)

[Transferring Settings from a Computer](#)

Parent topic: [Adjusting Projector Features](#)



Saving Settings to a USB Flash Drive

You can save the projector settings you want to transfer to a USB flash drive.

Note: Use an empty flash drive. If the drive contains other files, the transfer may not complete correctly. The flash drive must use the FAT format and cannot have any security features.

1. Turn off the projector and unplug the power cord from the projector's power inlet.
2. Insert the flash drive into the **USB-A** port.

Note: Connect the flash drive directly to the projector. Do not use a hub or your settings may not be saved correctly.

3. Press and hold the  return button on the remote control as you connect the power cord to the projector.
4. When the status light turns on, release the  return button.

The light flashes to indicate that settings are transferring to the flash drive. When the light stops flashing, it turns blue and the projector enters standby mode.

Caution: Do not unplug the power cord or remove the flash drive while the light is flashing. This could damage the projector.

Note: If the status light flashes orange, the batch setup file may be corrupt or the cable is not connected correctly. Disconnect the USB cable, then unplug the projector and try the procedure again. If the problem continues, unplug the projector and contact Epson for help.

5. Once the projector enters standby mode, remove the flash drive.

Parent topic: [Copying Menu Settings Between Projectors](#)

Transferring Settings from a USB Flash Drive



After saving projector settings to a USB flash drive, you can transfer them to another projector of the same model.

Note: Make sure the USB flash drive contains only a single settings transfer from another projector of the same model. The settings are contained in a file called **pjconfdata.bin**. If the drive contains other files, the transfer may not complete correctly.

Do not adjust image settings on a projector until after you transfer settings to it. Otherwise, you may have to repeat your adjustments.

1. Turn off the projector and unplug the power cord from the projector's power inlet.
2. Insert the flash drive into the **USB-A** port.

Note: Connect the flash drive directly to the projector. Do not use a hub or your settings may not be saved correctly.

3. Press and hold the  menu button on the remote control as you connect the power cord to the projector.
4. When the status light turns on, release the  menu button.

The light flashes to indicate that settings are transferring to the projector. When the light stops flashing, it turns blue and the projector enters standby mode.

Caution: Do not unplug the power cord or remove the flash drive while the light is flashing. This could damage the projector.

Note: If the status light flashes orange, the batch setup file may be corrupt or the cable is not connected correctly. Disconnect the USB cable, then unplug the projector and try the procedure again. If the problem continues, unplug the projector and contact Epson for help.

5. Once the projector enters standby mode, remove the flash drive.

Parent topic: [Copying Menu Settings Between Projectors](#)

Saving Settings to a Computer

You can save the projector settings you want to transfer to a computer.

Your computer must be running one of the following operating systems:

- Windows 8.x
- Windows 10
- Windows 11
- macOS 10.12.x or later

1. Turn off the projector and unplug the power cord from the projector's power inlet.
2. Connect a USB Type-A to Type-B cable to your projector's **Service** port.
3. Connect the other end to any available USB port on your computer.
4. Press and hold the ↵ return button on the remote control as you connect the power cord to the projector.
5. When the status light turns on, release the ↵ return button.

The projector shows up as a removable disk on your computer.

6. Open the removable disk and copy the **pjconfdata.bin** file to your computer.
7. Once the file has copied, do one of the following:
 - **Windows:** Open the **My Computer**, **Computer**, **Windows Explorer**, or **File Explorer** utility. Right-click the name of your projector (listed as a removable disk) and select **Eject**.
 - **Mac:** Drag the removable disk icon for your projector from the desktop into the trash.

The projector turns off when you disconnect the USB cable.

Parent topic: [Copying Menu Settings Between Projectors](#)



Transferring Settings from a Computer

After saving projector settings to a computer, you can transfer them to another projector of the same model.

Your computer must be running one of the following operating systems:

- Windows 8.x
- Windows 10
- Windows 11
- macOS 10.12.x or later

Do not adjust image settings on a projector until after you transfer settings to it. Otherwise, you may have to repeat your adjustments.

1. Turn off the projector and unplug the power cord from the projector's power inlet.
2. Connect a USB cable to your projector's **Service** port.
3. Connect the other end to any available USB port on your computer.
4. Press and hold the  menu button on the control panel or remote control as you turn on the power switch.
5. When the status light turns on, release the  menu button.
The projector shows up as a removable disk on your computer.
6. Copy the **pjconfdata.bin** file from your computer to the removable disk.

Note: Do not copy any other files to the removable disk.

7. Once the file has copied, do one of the following:
 - **Windows:** Open the **My Computer**, **Computer**, **Windows Explorer**, or **File Explorer** utility. Right-click the name of your projector (listed as a removable disk) and select **Eject**.
 - **Mac:** Drag the removable disk icon for your projector from the desktop into the trash.
- Disconnect the USB cable. When the status indicator stops flashing, the projector turns off.

Caution: Do not unplug the power cord while the light is flashing. This could damage the projector.

Parent topic: [Copying Menu Settings Between Projectors](#)

Adjusting the Menu Settings

Follow the instructions in these sections to access the projector menu system and change projector settings.

[Using the Projector's Menus](#)

[Image Quality Settings - Image Menu](#)

[Projector Feature Settings - Settings Menu](#)

[Projector Information Display - Info Menu](#)

[Projector Reset Options - Reset Menu](#)

Using the Projector's Menus

You can use the projector's menus to adjust the settings that control how your projector works. The projector displays the menus on the screen.

1. Press the  menu button on the projector remote control.

You see a screen like this:

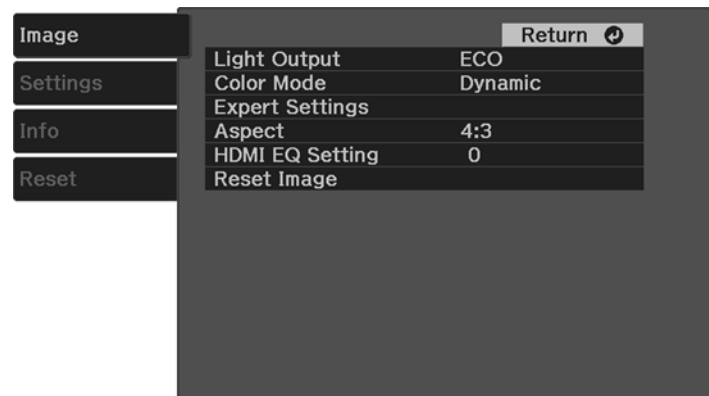

2. Press the up or down arrow button to move through the menus listed on the left. The settings for each menu are displayed on the right.

Note: The available settings depend on the current input source.

3. To change settings in the displayed menu, press **Enter**.

4. Press the up or down arrow button to move through the settings.
5. Change the settings using the buttons listed on the bottom of the menu screens.
6. To return all the menu settings to their default values, select **Reset**.
7. When you finish changing settings on a menu, press the ↩ return button.
8. Press the ☰ menu button to exit the menu or the ↩ return button to return to the previous screen.

Parent topic: [Adjusting the Menu Settings](#)

Image Quality Settings - Image Menu

Settings on the Image menu let you adjust the quality of your image for the input source you are currently using. The available settings depend on the currently selected input source.

Setting	Options	Description
Light Output	High Low (ECO)	Adjusts lamp brightness
Color Mode	See the list of available Color Modes	Adjusts the vividness of image colors for various image types and environments

Setting	Options	Description
Expert Settings	Brightness	Brightness: lightens or darkens the overall image
		Contrast: adjusts the difference between light and dark areas in the image
		Scene Adaptive Gamma: adjusts the color depending on the displayed scene; larger numbers enhance contrast
	Color	Color Saturation: adjusts the color intensity of the image
		Tint: adjusts the balance of green to magenta tones in the image
		White Balance: adjusts colors in detail
Color Temp.: sets the color temperature according to the selected color mode; lower values tint the image red, and higher values tint the image blue		
	Customized: adjusts the individual RGB components of the offset and gain	
	Sharpness	Adjusts the sharpness or softness of image details
Aspect	See the list of available aspect ratios	Sets the aspect ratio (width-to-height ratio) for the input source.

Setting	Options	Description
HDMI EQ Setting	—	Adjusts the signal level of the HDMI input. Change the setting if there is interference with the signal or if there is no image. Note: If there is no image when using a media streaming device, select 1 as the setting value.
Reset Image	—	Resets all Image menu settings to their defaults

Note: The **Brightness** setting does not affect lamp brightness. To change the lamp brightness, adjust the **Light Output** setting.

Parent topic: [Adjusting the Menu Settings](#)

Related references

[Available Color Modes](#)

[Available Image Aspect Ratios](#)

Projector Feature Settings - Settings Menu

Options on the Settings menu let you customize various projector features.

Setting	Options	Description
Volume	—	Adjusts the volume of the projector's speaker

Setting	Options	Description
Installation	Keystone	<p>Adjusts image shape to rectangular (horizontally and vertically)</p> <p>H/V Keystone: lets you manually correct horizontal and vertical sides</p> <p>Quick Corner: select to correct image shape and alignment using an on-screen display</p>
	Zoom	Adjusts the image size
	Image Shift	<p>Shifts the image position horizontally and vertically.</p> <p>This feature is not available if the Zoom option is set to the widest setting.</p>
	Projection	Selects the way the projector faces the screen

Setting	Options	Description
Installation	Pattern	<p>Selects various pattern display options.</p> <p>Note: If a pattern is displayed for a long time, a residual image may be visible in projected images</p> <p>Pattern Display: lets you display the selected pattern type on the screen to aid in presentation.</p> <p>Pattern Type: select from available patterns or the User Pattern.</p> <p>User Pattern: captures a projected screen and saves it as a pattern for display.</p> <p>Test Pattern: displays a test pattern to assist in focusing and zooming the image and correcting image shape (press the ↵ return button to cancel pattern display).</p>
Display	Messages	Select On to display messages for color mode name, aspect ratio, or high temperature warning
	Startup Screen	Select On to display Epson logo at startup
	User's Logo	Creates a screen that the projector displays to identify itself and enhance security.
	A/V Mute	Sets the screen color or logo to display when the A/V Mute feature is active.

Setting	Options	Description
Operation	Various options (see table below)	Various options (see table below)
Language	Various languages	Sets the language for the projector menus and messages
Reset Settings	—	Resets all settings in the Settings menu, except for the following: <ul style="list-style-type: none"> • Zoom • Image Shift • Projection • Audio Out Device • Power On Link • Power Off Link • High Altitude Mode • Language

Operation settings

Options	Description
HDMI Link	<p>Adjusts HDMI Link options that allow the projector remote control to control HDMI-connected devices that support the CEC standard</p> <p>Device Connections: lists the device connected to the HDMI port</p> <p>HDMI Link: turns HDMI Link on or off</p> <p>Audio Out Device: selects whether to output audio from the internal speakers or a connected audio/video system</p> <p>Power On Link: controls what happens when you turn on the projector or connected device</p> <ul style="list-style-type: none"> • Bidirectional: automatically turns on the connected device when you turn on the projector, and vice versa • Device -> PJ: automatically turns on the projector when you turn on the connected device • PJ -> Device: automatically turns on the connected device when you turn on the projector. <p>Power Off Link: controls if the connected device is turned off or not when you turn off the projector</p>
Sleep Mode	Select On to place the projector in standby mode after a certain interval of inactivity
Sleep Mode Timer	Sets the sleep mode interval between 1 and 30 minutes
A/V Mute Timer	Select On to automatically turn off the projector after 30 minutes if A/V Mute is enabled
Direct Power On	Turns on the projector when you plug it in
Auto Power On	Automatically turns on the projector when it receives an image signal (available only when Standby Mode is set to Communication On)
High Altitude Mode	Select On to regulate the projector temperature above 4921 feet (1500 m)
Indicators	Turns off the indicator on the projector

Options	Description
Advanced	<p>Log Save Destination: sets the location where the projector saves error and operation log files</p> <p>Batch Setup Range: select to copy the projector menu settings using the batch setup feature</p>

Parent topic: [Adjusting the Menu Settings](#)

Related tasks

[Resizing the Image Using Zoom](#)

[Correcting Image Shape with H/V Keystone](#)

[Correcting Image Shape with Quick Corner](#)

[Adjusting the Image Position Using Image Shift](#)

[Changing the Projection Mode Using the Menus](#)

[Displaying a Test Pattern](#)

[Saving a User's Logo Image to Display](#)

[Shutting Off the Picture and Sound Temporarily](#)

[Selecting the Language for the Projector Menus](#)

[Operating Connected Devices Using the HDMI Link Features](#)

Projector Information Display - Info Menu

You can display information about the projector and input sources by viewing the Info menu. However, you cannot change any settings in the menu.

Select **Projector Info** to display the settings described below. Select **Version** to display the projector's firmware version.

Information item	Description
Lamp Hours	Displays the number of hours the projector has been used in High and Low (Eco) modes since it was turned on
Source	Displays the name of the port to which the current input source is connected
Input Signal	Displays the input signal setting of the current input source
Resolution	Displays the resolution of the current input source

Information item	Description
Refresh Rate	Displays the refresh rate of the current input source
Sync Info	Displays information that may be needed by a service technician
Status	Displays information about projector problems that may be needed by a service technician
Serial Number	Displays the projector's serial number

Parent topic: [Adjusting the Menu Settings](#)

Projector Reset Options - Reset Menu

You can reset most of the projector settings to their default values using the Reset menu.

Setting	Description
Reset All Config	Resets most of the projector settings to their defaults, except the Zoom , Image Shift , and Language settings

Parent topic: [Adjusting the Menu Settings](#)

Maintaining and Transporting the Projector

Follow the instructions in these sections to maintain your projector and transport it from place to place.

[Projector Maintenance](#)

[Replacing the Remote Control Batteries](#)

[Transporting the Projector](#)

Projector Maintenance

Your projector needs little maintenance to keep working at its best.

You may need to clean the lens periodically, and clean the air vents to prevent the projector from overheating due to blocked ventilation.

The only parts you should replace are the remote control batteries. If any other part needs replacing, contact Epson or an authorized Epson servicer.

Warning: Before cleaning any part of the projector, turn it off and unplug the power cord. Never open any cover on the projector, except as specifically explained in this manual. Dangerous electrical voltages in the projector can injure you severely.

Warning: Do not try to service this product yourself, except as specifically explained in this manual. Refer all other servicing to qualified servicers.

[Cleaning the Lens](#)

[Cleaning the Projector Case](#)

[Cleaning the Air Vents](#)

Parent topic: [Maintaining and Transporting the Projector](#)

Cleaning the Lens

Clean the projector's lens periodically, or whenever you notice dust or smudges on the surface. Make sure you unplug the projector before cleaning the lens.

- To remove dust or smudges, gently wipe the lens with lens-cleaning paper.

- To remove stubborn smudges, moisten a soft, lint-free cloth with lens cleaner and gently wipe the lens. Do not spray any liquid directly on the lens.

Warning: Do not use a lens cleaner that contains flammable gas. The high heat generated by the projector lamp may cause a fire.

Caution: Do not wipe the lens immediately after turning off the light source; otherwise, it could be damaged. Do not use glass cleaner or any harsh materials to clean the lens and do not subject the lens to any impacts; you may damage it. Do not use canned air, or the gases may leave a residue. Avoid touching the lens with your bare hands to prevent fingerprints on or damage to the lens surface.

Parent topic: [Projector Maintenance](#)

Related tasks

[Turning Off the Projector](#)

Cleaning the Projector Case

Before cleaning the projector case, turn off the projector and unplug the power cord.

- To remove dust or dirt, use a soft, dry, lint-free cloth.
- To remove stubborn dirt, use a soft cloth moistened with water and mild soap. Do not spray liquid directly on the projector.

Caution: Do not use wax, alcohol, benzine, paint thinner, or other chemicals to clean the projector case. These can damage the case. Do not use canned air, or the gases may leave a flammable residue.

Parent topic: [Projector Maintenance](#)

Related tasks

[Turning Off the Projector](#)

Cleaning the Air Vents

Clean the projector's air vents if they get dusty, or if you see a message telling you to clean them.

1. Turn off the projector and unplug the power cord.

2. Carefully remove the dust using a vacuum cleaner or a brush.

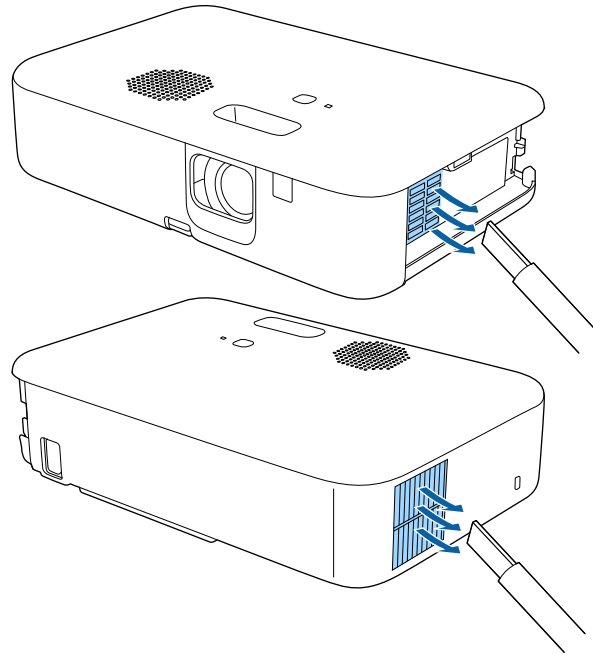

Caution: Do not use canned air. The gases may leave a flammable residue or push dust and debris into the projector's optics or other sensitive areas.

Parent topic: [Projector Maintenance](#)

Related tasks

[Turning Off the Projector](#)

Replacing the Remote Control Batteries

The remote control uses two AAA manganese or alkaline batteries. Replace the batteries as soon as they run out.

Caution: Use only the type of batteries specified in this manual. Do not install batteries of different types, or mix new and old batteries.

1. Remove the battery cover as shown.

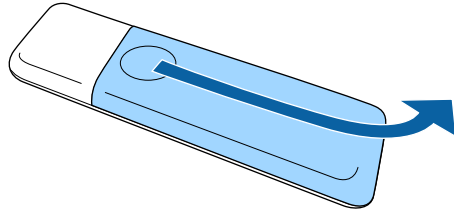

2. Remove the old batteries.

Warning: If the battery fluid has leaked, wipe it away with a soft cloth and avoid getting the fluid on your hands. If it gets on your hands, wash them immediately to avoid injury.

3. Insert the batteries with the + and – ends facing as shown.

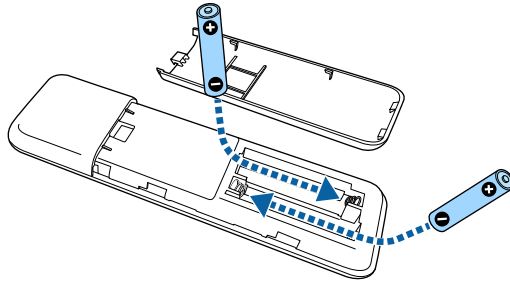

Warning: Make sure the batteries are inserted in the correct positions. If the batteries are not inserted correctly, they could explode or leak, causing a fire, injury, or damage to the product.

4. Replace the battery cover and slide it up until it clicks into place.

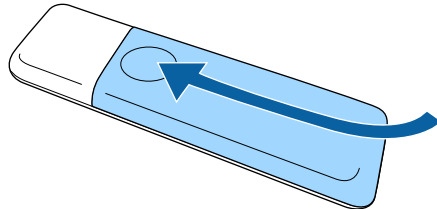

Warning: Dispose of used batteries according to local regulations. Do not expose batteries to heat or flame. Keep batteries out of the reach of children; they are choking hazards and are very dangerous if swallowed.

Parent topic: [Maintaining and Transporting the Projector](#)

Transporting the Projector

The projector contains precision parts, some of which are glass. Follow the guidelines here to transport, ship, or store the projector safely.

1. Remove any equipment connected to the projector.
2. Turn off the projector.
3. Make sure the status indicator is not lit, then unplug the power cord.
4. Do one of the following:
 - When transporting the projector a long distance or as checked luggage, pack it in a firm box with cushioning around it and mark the box "Fragile."
 - When shipping the projector for repairs, place it in its original packing materials, if possible, or use equivalent materials with cushioning around the projector. Mark the box "Fragile."

Note: Epson shall not be liable for any damages incurred during transportation.

Parent topic: [Maintaining and Transporting the Projector](#)

Related references

[Projector Light Status](#)

Related tasks

[Turning Off the Projector](#)

Solving Problems

Check the solutions in these sections if you have any problems using the projector.

[Projection Problem Tips](#)

[Projector Light Status](#)

[Solving Projector or Remote Control Operation Problems](#)

[Solving Image or Sound Problems](#)

[Solutions to Streaming Device Problems](#)

[Solutions to HDMI Link Problems](#)

[Solutions When a Message to Replace the Projector is Displayed](#)

[Where to Get Help \(U.S. and Canada\)](#)

[Where to Get Help \(Latin America\)](#)

Projection Problem Tips

If the projector is not working properly, try turning it off and unplugging it. Then plug it back in and turn it on.

If this does not solve the problem, check the following:

- The lights on the projector may indicate what the problem is.
- The solutions in this manual can help you solve many problems.

If none of these solutions help, you can contact Epson for technical support.

Parent topic: [Solving Problems](#)

Related references

[Projector Light Status](#)

Projector Light Status

The light on the projector indicates the projector status and lets you know when a problem occurs. Check the status and color of the light and look for a solution in the tables here.

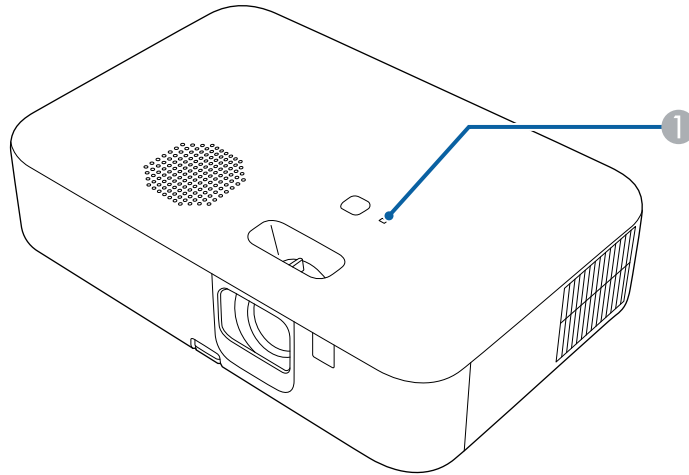

1 Status light

Status light	Status and solution
Blue	Normal operation
Flashing blue	The projector is warming up, shutting down, or initializing the projector. The remote control may not function if the status indicator is flashing blue.
Off	The projector is in standby or sleep mode. When you press the power button on the projector or remote, projection begins. <ul style="list-style-type: none">• Make sure that the vents are not clogged with dust or obstructed by nearby objects.• If the problem persists, unplug the projector and contact Epson for help.

Status light	Status and solution
Orange	Projector is too hot and has turned off. <ul style="list-style-type: none"> • Let the projector cool down for at least five minutes • Make sure that the vents and air filter are not clogged with dust or obstructed by nearby objects. • Clean or replace the air filter. • Make sure the environmental temperature is not too hot. • If the problem persists, unplug the projector and contact Epson for help.
Flashing orange	One of the following has occurred: <ul style="list-style-type: none"> • The lamp has a problem • A fan or sensor has a problem • An internal projector error has occurred. • Power error (Ballast) Turn the projector off, unplug it, and contact Epson for help.

Note: If the light displays a pattern not listed in the tables above, turn the projector off, unplug it, and contact Epson for help.

Parent topic: [Solving Problems](#)

Related references

[Projector Environmental Specifications](#)

[Where to Get Help \(U.S. and Canada\)](#)

[Where to Get Help \(Latin America\)](#)

Related tasks

[Cleaning the Air Vents](#)

Solving Projector or Remote Control Operation Problems

Check the solutions in these sections if you have problems operating the projector or remote control.

Note: For Android TV support, visit <https://support.google.com/androidtv/>.

[Solutions to Projector Power or Shut-Off Problems](#)

[Solutions to Remote Control Problems](#)

Parent topic: [Solving Problems](#)

Solutions to Projector Power or Shut-Off Problems

If the projector does not come on when you press the power button or it shuts off unexpectedly, try the following solutions:

- Make sure the power cord is securely connected to the projector and to a working electrical outlet.
- If the projector's light source turns off unexpectedly, the A/V mute timer may be enabled. Select **Off** as the **A/V Mute Timer** setting.
- If the projector's status light is orange, the projector has overheated and shut off. Check the solutions for this light status.
- If the power button on the remote control does not turn on the projector, check its batteries.
- The power cord may be defective. Try another power cord. If that doesn't work, disconnect the cord and contact Epson.
- The cooling fans may run in standby status depending on the projector settings. Also, when the projector wakes from standby status, the fans may cause an unexpected noise. This is not a malfunction.
- HDMI Link settings on connected devices could power on or power off your projector. Adjust the settings on connected devices accordingly.

Parent topic: [Solving Projector or Remote Control Operation Problems](#)

Related references

[Projector Light Status](#)

[Projector Feature Settings - Settings Menu](#)

Related tasks

[Replacing the Remote Control Batteries](#)

Solutions to Remote Control Problems

If the projector does not respond to remote control commands, try the following solutions:

- Check that the remote control batteries are installed correctly and have power. If necessary, replace the batteries.
- Make sure you are operating the remote control within the reception angle and range of the projector.

- Make sure the projector is not warming up or shutting down.
- Check to see if a button on the remote control is stuck down, causing it to enter sleep mode. Release the button to wake the remote control up.
- Make sure you are using the projector remote control and not the remote control for Android TV.
- Strong fluorescent lighting, direct sunlight, or infrared device signals may be interfering with the projector's remote receivers. Dim the lights or move the projector away from the sun or interfering equipment.
- If you lose the remote control, you can purchase another from an Epson parts distributor.

Parent topic: [Solving Projector or Remote Control Operation Problems](#)

Related references

[Remote Control Operation](#)

[Where to Get Help \(U.S. and Canada\)](#)

[Where to Get Help \(Latin America\)](#)

[Projector Light Status](#)

[Projector Parts - Remote Control](#)

Related tasks

[Replacing the Remote Control Batteries](#)

[Pairing the Remote Control](#)

Solving Image or Sound Problems

Check the solutions in these sections if you have any problems with projected images or sound.

[Solutions When No Image Appears](#)

[Solutions When "No Signal" Message Appears](#)

[Solutions When the Image is Not Rectangular](#)

[Solutions When the Image is Fuzzy or Blurry](#)

[Solutions When Only a Partial Image Appears](#)

[Solutions When the Image Contains Noise or Static](#)

[Solutions When the Image is Flickering](#)

[Solutions When the Image Brightness or Colors are Incorrect](#)

[Solutions When the Image is Upside Down](#)

[Solutions to Sound Problems](#)

Parent topic: [Solving Problems](#)

Solutions When No Image Appears

If no image appears, try the following solutions:

- Press the  A/V mute button on the projector remote control to see if the image was temporarily turned off.
- Check the status light to confirm the projector is operating normally.
- Make sure all necessary cables are securely connected and the power is on for the projector and connected video sources.
- Try using a shorter HDMI cable.
- Use a different display adapter.
- Try connecting the video source directly to the projector.
- Press the projector's power button to wake it from standby or sleep mode. Also see if your connected computer is in sleep mode or displaying a blank screen saver.
- If you are projecting from a streaming device, make sure it is powered by the USB power cable inside the projector. Turn on the connected streaming device or video source, and press the play button to start a video, if necessary.
- Make sure the connected device meets the HDMI CEC standard. See the documentation supplied with the device for more information. If necessary, set the CEC function for the connected device again and restart the device. Turn off the projector and the connected streaming device or video source, and then turn them back on.
- Turn off the projector and the connected streaming device or video source, and then turn them back on.
- If you are projecting from a laptop computer, make sure it is set up to display on an external monitor.
- Make sure the computer's display resolution does not exceed the projector's resolution and frequency limits. If necessary, select a different display resolution for your computer. (See your computer manual for details.)
- If the other solutions do not solve the problem, reset all of the projector settings using the options on the **Reset** menu.

Parent topic: [Solving Image or Sound Problems](#)

Related references

[Projector Parts - Remote Control](#)

[Projector Light Status](#)

[Projector Reset Options - Reset Menu](#)

Related tasks

[Operating Connected Devices Using the HDMI Link Features](#)
[Turning On the Projector](#)

Solutions When "No Signal" Message Appears

If the "No Signal" message appears, try the following solutions:

- Turn on the connected computer or video source, and press its play button to begin your presentation, if necessary.
- Check the connection from the projector to your video sources.
- If you are projecting from a laptop computer, make sure it is set up to display on an external monitor.
- If necessary, turn the projector and the connected computer or video source off and then on again.
- If you are projecting from an HDMI source, replace the HDMI cable with a shorter one.
- Connect the video source directly to the projector.
- Check that the source device is not sending a signal that has too high a bandwidth for the cable or the projector. Click the link below to see the supported video display formats.

[Displaying From a PC Laptop](#)

[Displaying From a Mac Laptop](#)

Parent topic: [Solving Image or Sound Problems](#)

Related references

[Projector Reset Options - Reset Menu](#)

[Supported Video Display Formats](#)

Displaying From a PC Laptop

If you see the "No Signal" message when you display from a PC laptop, you need to set up the laptop to display on an external monitor.

1. Hold down the laptop's **Fn** key and press the key labeled with a monitor icon or **CRT/LCD**. (See your laptop manual for details.) Wait a few seconds for an image to appear. To display on both the laptop's monitor and the projector, try pressing the same keys again.

Note: On Windows 7 or later, hold down the Windows key and press **P** at the same time, then click **Duplicate**.

2. If the same image is not displayed by the laptop and projector, check the Windows **Display** utility to make sure the external monitor port is enabled and extended desktop mode is disabled. (See your computer or Windows manual for instructions.)
3. If necessary, check your video card settings and set the multiple display option to **Clone**, **Mirror**, or **Duplicate**.

Parent topic: [Solutions When "No Signal" Message Appears](#)

Displaying From a Mac Laptop

If you see the "No Signal" message when you display from a Mac laptop, you need to set up the laptop for mirrored display. (See your laptop manual for details.)

1. Open the **System Preferences** utility and select **Displays**, **Display**, or **Color LCD**.
2. Click the **Arrange** or **Arrangement** tab.
3. Select the **Mirror Displays** checkbox.

Parent topic: [Solutions When "No Signal" Message Appears](#)

Solutions When the Image is Not Rectangular

If the projected image is not evenly rectangular, try the following solutions:

- Place the projector directly in front of the center of the screen, facing it squarely, if possible.
- Adjust the image shape using the keystone settings in the projector's menu.

Parent topic: [Solving Image or Sound Problems](#)

Related concepts

[Projector Placement](#)

Related tasks

[Correcting Image Shape with H/V Keystone](#)

[Correcting Image Shape with Quick Corner](#)

Solutions When the Image is Fuzzy or Blurry

If the projected image is fuzzy or blurry, try the following solutions:

- Adjust the image focus using the focus lever.
- Clean the projector lens.
- Position the projector close enough to the screen.
- Position the projector so the keystone adjustment angle is not so wide that it distorts the image.

- Adjust the **Sharpness** setting to improve image quality.
- If you are projecting from a computer, use a lower resolution or adjust the computer's resolution to match the projector's native resolution, if possible.

Parent topic: [Solving Image or Sound Problems](#)

Related references

[Projection Distance](#)

[Image Quality Settings - Image Menu](#)

[Supported Video Display Formats](#)

Related tasks



[Adjusting Picture Quality in Detail](#)

[Correcting Image Shape with H/V Keystone](#)

[Correcting Image Shape with Quick Corner](#)

Solutions When Only a Partial Image Appears

If only a partial computer image appears, try the following solutions:

- Select **Image > Aspect Ratio** and set it to **Auto**.
- If you zoomed into or out of the image using the  and  buttons, press the  return button until the projector returns to a full display.
- Check your computer display settings to disable dual display and set the resolution within the projector's limits. (See your computer manual for details.)
- Check the resolution assigned to your presentation files to see if they are created for a different resolution than you are projecting in. (See your software help for details.)
- Make sure you selected the correct **Projection** setting in the Installation menu.

Parent topic: [Solving Image or Sound Problems](#)

Related references

[Supported Video Display Formats](#)

[Projector Reset Options - Reset Menu](#)

Related tasks

[Changing the Image Aspect Ratio](#)

Solutions When the Image Contains Noise or Static

If the projected image seems to contain electronic interference (noise) or static, try the following solutions:

- Check the cables connecting your computer or video source to the projector. They should be:
 - Separated from the power cord to prevent interference
 - Securely connected at both ends
 - Not connected to an extension cable
- Try decreasing the **Sharpness** setting in the **Image** menu.
- Select a computer video resolution and refresh rate that are compatible with the projector.
- If you connected an extension power cable, try projecting without it to see if it caused interference in the signal.

Parent topic: [Solving Image or Sound Problems](#)

Related references

[Supported Video Display Formats](#)

Related tasks

[Adjusting Picture Quality in Detail](#)

Solutions When the Image is Flickering

If the projected screen flickers, try the following solutions:

- If the screen flickers only when a video signal is input, try replacing the cable connecting the projector and video device.
- If **Light Output** is set to **Low (Eco)**, change this to **High** and try projecting an image for about two hours to see if it still flickers.
- Disconnect all the cables connecting the projector and video devices, confirm no signal is being input, and then reset all the projector settings by enabling the **Reset All Config** setting in the projector's **Reset** menu.

Parent topic: [Solving Image or Sound Problems](#)

Related references

[Image Quality Settings - Image Menu](#)

[Projector Reset Options - Reset Menu](#)

Solutions When the Image Brightness or Colors are Incorrect

If the projected image is too dark or light, or the colors are incorrect, try the following solutions:

- Try selecting a color mode that best fits the image and environment.
- Check your video source settings.
- Adjust the available settings on the Image menu for the current input source, such as **Brightness**, **Contrast**, **Tint**, and/or **Color Saturation**.
- Make sure all the cables are securely connected to the projector and your video device. If you connected long cables, try connecting shorter cables.
- Position the projector close enough to the screen.

Parent topic: [Solving Image or Sound Problems](#)

Related references

[Image Quality Settings - Image Menu](#)

[Available Color Modes](#)

Related tasks

[Adjusting Picture Quality in Detail](#)

[Changing the Color Mode](#)

Solutions When the Image is Upside Down

If the projected image is upside down, try the following solutions:

- Select the correct projection mode.



Parent topic: [Solving Image or Sound Problems](#)

Related tasks

[Changing the Projection Mode Using the Menus](#)

Solutions to Sound Problems

If there is no sound when you expect it or the volume is too low or high, try the following solutions:

- Adjust the projector's volume settings.
- Press the  mute button on the remote control to resume audio if it was temporarily muted.
- Press the  A/V mute button on the projector remote control to resume video and audio if they were temporarily stopped.
- Make sure the **Audio Out Device** settings are correct.

- Check your computer or video source to make sure the volume is turned up and the audio output is set for the correct source.
- If you do not hear sound from an HDMI source, set the connected device to PCM output.
- If you are using a Mac and you do not hear sound from an HDMI source, make sure your Mac supports audio through the HDMI port. If not, you need to connect an audio cable.

Parent topic: [Solving Image or Sound Problems](#)

Related references

[Projector Feature Settings - Settings Menu](#)

Related tasks

[Shutting Off the Picture and Sound Temporarily](#)

[Operating Connected Devices Using the HDMI Link Features](#)

[Controlling the Volume with the Volume Buttons](#)

Solutions to Streaming Device Problems

If you cannot operate the Epson streaming device included with your projector using the projector remote control, try the following solutions:

- Make sure the streaming device is securely connected to the projector's HDMI extension cable and USB power cable.
- Make sure the streaming device is connected to Wi-Fi. You need an Internet connection to view online streaming content.
- Make sure the projector remote control is paired to the streaming device.
- Make sure you are using the projector remote control and not the remote control for Android TV.

Caution: The streaming device included with your projector is designed for use with this projector. Epson takes no responsibility for repair costs incurred by connecting any other streaming device to your projector.

Note: After repairing the streaming media player, Epson may return the device to you in its initial state. Make sure you make a note of the account information of each online service before you contact your local dealer or the nearest Epson repair center.

Parent topic: [Solving Problems](#)

Related references

[Projector Parts - Remote Control](#)

Related tasks

[Setting Up Android TV](#)

[Pairing the Remote Control](#)

[Connecting to a Streaming Media Player](#)

Solutions to HDMI Link Problems

If you cannot control an HDMI device using the HDMI Link feature, try the following solutions:

- Make sure all necessary cables are securely connected and the power is on for the projector and connected video sources.
- Make sure the cables meet the HDMI CEC standard.
- Make sure the connected device meets the HDMI CEC standard. See the documentation supplied with the device for more information.
- Replace the HDMI cable or try a shorter one.
- Check if the device is available in the **Device Connections** list in the Settings menu. If the device does not appear, it does not meet the HDMI CEC standards. Connect a different device.
- Make sure the connected devices are turned on and in standby status. See the documentation supplied with the device for more information.
- If you connected a new device or changed any connections, make sure the CEC function is set for the connected device. You may need to restart the device.

Parent topic: [Solving Problems](#)

Related references

[Projector Feature Settings - Settings Menu](#)

Related tasks

[Operating Connected Devices Using the HDMI Link Features](#)

Solutions When a Message to Replace the Projector is Displayed

At the end of the projector lamp's life, the projector displays a message about replacing the projector. Turn the projector off and consider replacing the projector even if the lamp continues to work.

Warning: If you continue to use the projector after the lamp's life expires, the possibility that the lamp may explode increases.

If the lamp breaks, note the following points:

- Ventilate the area immediately.
- Do not swing or tilt the projector. Shards of glass may fall out and could cause an injury.
- If any shards of glass get into your eyes or mouth, contact a doctor immediately.

Parent topic: [Solving Problems](#)

Related references

[Projector Lamp Specifications](#)

Where to Get Help (U.S. and Canada)

If you need to contact Epson for technical support services, use the following support options.

Internet Support

Visit Epson's support website at epson.com/support (U.S.) or epson.ca/support (Canada) and select your product for solutions to common problems with your projector. You can download utilities and documentation, get FAQs and troubleshooting advice, or e-mail Epson with your questions.

Speak to a Support Representative

To use the Epson PrivateLine Support service, call (800) 637-7661. This service is available for the duration of your warranty period. You may also speak with a projector support specialist by dialing (562) 276-4394 (U.S.) or (905) 709-3839 (Canada).

Support hours are Monday through Friday, 7 AM to 4 PM, Pacific Time.

Days and hours of support are subject to change without notice. Toll or long distance charges may apply.

Before you call, have the following information ready:

- Product name
- Product serial number (located on the bottom or rear of the projector, or in the menu system)
- Proof of purchase (such as a store receipt) and date of purchase
- Computer or video configuration
- Description of the problem

Purchase Supplies and Accessories

You can purchase screens, other optional accessories, and replacement parts from an Epson authorized reseller. To find the nearest reseller, call 800-GO-EPSON (800-463-7766) in the U.S. or 800-807-7766 in Canada. Or you can purchase online at epsonstore.com (U.S. sales) or epsonstore.ca (Canadian sales).

You can purchase a replacement remote control from an Epson parts distributor [here](#) (U.S. sales) or [here](#) (Canadian sales).

Parent topic: [Solving Problems](#)

Where to Get Help (Latin America)

If you need to contact Epson for technical support services, use the following support options.

Internet Support

Visit Epson's support website at latin.epson.com/support and select your product for solutions to common problems with your projector. You can download utilities and documentation, get FAQs and troubleshooting advice, or e-mail Epson with your questions.

Speak to a Support Representative

Before you call for support, please have the following information ready:

- Product name
- Product serial number (located on the bottom or rear of the projector, or in menu system)
- Proof of purchase (such as a store receipt) and date of purchase
- Computer or video configuration
- Description of the problem

Then call:

Country	Telephone
Argentina	(54 11) 5167-0300 0800-288-37766
Bolivia*	800-100-116
Brazil	State capitals and metropolitan areas: 3004-6627 Other areas: 0800-377-6627 / 0800-EPSONBR
Chile	(56 2) 2484-3400

Country	Telephone
Colombia	Bogota: (57 1) 602-4751 Other cities: 01-8000-915235
Costa Rica	800-377-6627
Dominican Republic*	1-888-760-0068
Ecuador*	1-800-000-044
El Salvador*	800-6570
Guatemala*	1-800-835-0358
Mexico	Mexico City: (52 55) 1323-2052 Other cities: 01-800-087-1080
Nicaragua*	00-1-800-226-0368
Panama*	00-800-052-1376
Paraguay	009-800-521-0019
Peru	Lima: (51 1) 418-0210 Other cities: 0800-10126
Uruguay	00040-5210067
Venezuela	(58 212) 240-1111

*Contact your local phone company to call this toll-free number from a mobile phone.

Note: Toll or long distance charges may apply. If your country does not appear on the list, contact the sales office in the nearest country.

Purchase Supplies and Accessories

You can purchase optional accessories and replacement parts from an Epson authorized reseller. To find the nearest reseller, go to latin.epson.com. Or you can contact your nearest sales office as described in "Where to Get Help."

Parent topic: [Solving Problems](#)

Technical Specifications

These sections list the technical specifications of your projector.

[General Projector Specifications](#)

[Projector Lamp Specifications](#)

[Remote Control Specifications](#)

[Projector Dimension Specifications](#)

[Projector Electrical Specifications](#)

[Projector Environmental Specifications](#)

[Streaming Device Specifications](#)

[Projector Safety and Approvals Specifications](#)

[Supported Video Display Formats](#)

General Projector Specifications

Type of display	Poly-silicon TFT active matrix
Resolution	1920 × 1080 pixels (Full HD)
Lens	F=1.44 Focal length: 16.4 mm
Color reproduction	Up to 16.77 billion colors
Brightness	High light source mode: White light output 3000 lumens (ISO 21118 standard) Color light output 3000 lumens Note: Color brightness (color light output) and white brightness (white light output) will vary depending on usage conditions. Color light output measured in accordance with IDMS 15.4; white light output measured in accordance with ISO 21118.
Image size (in native aspect ratio)	26 inches (0.66 m) to 391 inches (9.9 m)

Projection distance (in native aspect ratio)	60" screen: 60" (1.58 m) to 84" (2.14 m)
Projection methods	Front, Rear
Optical aspect ratio (width-to-height)	16:9
Focus adjustment	Manual
Auto Keystone Correction	±30 °
Internal sound system	5 W (Monaural with enclosure)
Fan noise level	37 dB (High power consumption) 29 dB (ECO power consumption)
USB Type A port compatibility	One USB 2.0 compliant port for supplying power, firmware update, and batch setup
USB Type B port compatibility	One USB 2.0 compliant port for service

Parent topic: [Technical Specifications](#)

Projector Lamp Specifications

Type	UHE (Ultra High Efficiency)
Power consumption	188 W
Lamp life	High Power Consumption mode: Up to about 6000 hours ECO Power Consumption mode: Up to about 12000 hours

Note: Turn off this product when not in use to prolong the life of the projector. Lamp life will vary depending upon mode selected, environmental conditions, and usage. Brightness decreases over time.

Parent topic: [Technical Specifications](#)

Related references

[Solutions When a Message to Replace the Projector is Displayed](#)

Remote Control Specifications

Reception range	19.7 feet (6 m)
Batteries	Two alkaline or manganese AAA

Parent topic: [Technical Specifications](#)

Projector Dimension Specifications

Height (excluding feet)	3.2 inches (82 mm)
Width	12.6 inches (320 mm)
Depth	8.3 inches (211 mm)
Weight	Approx. 5.7 lb (2.6 kg)

Parent topic: [Technical Specifications](#)

Projector Electrical Specifications

Rated frequency	50/60 Hz
Power supply	100 to 240 V AC \pm 10% 2.9 - 1.3 A
Power consumption (100 to 120 V)	Operating: High Power Consumption mode: 284 W ECO Power Consumption mode: 223 W Standby: 0.5 W
Power consumption (220 to 240 V)	Operating: High Power Consumption mode: 270 W ECO Power Consumption mode: 214 W Standby: 0.5 W

Parent topic: [Technical Specifications](#)

Projector Environmental Specifications

Temperature	Operating: Up to 7500 feet (2286 m): 41 to 104 °F (5 to 40 °C) 7500 feet (2286 m) to 9843 feet (3000 m): 41 to 95 °F (5 to 35 °C) Storage: 14 to 140 °F (–10 to 60 °C)
Humidity (relative, non-condensing)	Operating: 20 to 80% Storage: 10 to 90%
Operating altitude	Up to 10000 feet (3048 m)

Parent topic: [Technical Specifications](#)

Streaming Device Specifications

Power supply	5V, 2A
Dimensions	Length: 3.7 inches (94.1 mm) Width: 1.2 inches (30.1 mm) Depth: 0.47 inch (12 mm)
Weight	1 ounce (28 g)
Temperature (no condensation)	Operating: 32 to 113 °F (0 to 45 °C) Storage: 4 to 158 °F (–20 to 70 °C)
Humidity	20 to 80%
HDMI version	1.4, 2.0 Supports HDCP 2.2

Wireless LAN	IEEE 802.11a (5 GHz)
	IEEE 802.11b (2.4 GHz)
	IEEE 802.11g (2.4 GHz)
	IEEE 802.11n (2.4 GHz and 5 GHz)
	IEEE 802.11ac (5 GHz)
Bluetooth	Bluetooth 5.0 Class 2 (2.4 GHz)

[Bluetooth Specifications](#)

Parent topic: [Technical Specifications](#)

Bluetooth Specifications

Version	Bluetooth Ver. 5.0
Output	Class 2
Communication distance	Approximately 32.8 ft (10 m)
Supported profiles	A2DP, AVRCP
Content protection	N/A
Frequency used	2.4 GHz band
Supported codecs	SBC

Parent topic: [Streaming Device Specifications](#)

Projector Safety and Approvals Specifications

United States	FCC Part 15B Class B (DoC)
	UL62368-1 2nd edition (cTUVus Mark)
Canada	ICES-003 Class B
	CSA C22.2 No.62368-1-14 (cTUVus Mark)

Parent topic: [Technical Specifications](#)

Supported Video Display Formats

For best results, your computer's monitor port or video card resolution should be set to display in the projector's native resolution. However, your projector includes Epson's SizeWise chip that supports other computer display resolutions, so your image will be resized to fit automatically.

Your computer's monitor port or video card refresh rate (vertical frequency) must be compatible with the projector. (See your computer or video card manual for details.)

The table here lists the compatible refresh rate and resolution for each compatible video display format.

Display format	Refresh rate (in Hz)	Resolution (in pixels)
HDMI Input Signals		
VGA	60	640 × 480
SVGA	60	800 × 600
XGA	60	1024 × 768
WXGA	60	1280 × 800
	60	1366 × 768
WXGA+	60	1440 × 900
WXGA++	60	1600 × 900
SXGA	60	1280 × 960
	60	1280 × 1024
SXGA+	60	1400 × 1050
WSXGA+	60	1680 × 1050
UXGA	60	1600 × 1200
1920 × 1080	50/60	1920 × 1080
WUXGA (Reduced Blanking)	60	1920 × 1200
SDTV (480i/480p)	59.94	720 × 480
SDTV (576i/576p)	50	720 × 576
HDTV (720p)	50/59.94/60	1280 × 720
HDTV (1080i)	50/59.94/60	1920 × 1080
HDTV (1080p)	23.98/24/29.97/30/50/59.94/60	1920 × 1080

Parent topic: [Technical Specifications](#)

Notices

Check these sections for important notices about your projector.

[Recycling \(U.S. and Canada\)](#)

[Important Safety Information](#)

[Important Safety Instructions](#)

[Warning Labels](#)

[List of Safety Symbols](#)

[Wireless Safety Instructions](#)

[FCC Compliance Statement](#)

[Binding Arbitration and Class Waiver](#)

[Trademarks](#)

[Copyright Notice](#)

Recycling (U.S. and Canada)

Epson offers a recycling program for end of life products. Please go to [this site](#) for information on how to return your products for proper disposal.

Parent topic: [Notices](#)

Important Safety Information

Caution: Never look into the projector lens when the light source is on. This can damage your eyes and is especially dangerous for children. Before cleaning any part of the projector, turn it off and unplug the power cord. Never open any cover on the projector, except as specifically explained in this manual. Dangerous electrical voltages in the projector can injure you severely. Except as specifically explained in this *User's Guide*, do not attempt to service this product yourself. Refer all servicing to qualified service personnel.

Warning: The projector and its accessories come packaged in plastic bags. Keep plastic bags away from small children to avoid any risk of suffocation.

Parent topic: [Notices](#)

Important Safety Instructions

Follow these safety instructions when setting up and using the projector:

- Do not look into the lens when the projector is on. The bright light can damage your eyes. Avoid standing in front of the projector so the bright light does not shine into your eyes.
- Do not mount the projector on a ceiling or wall.
- Do not install or place the projector vertically. Doing so may cause a malfunction.
- When turning on the projector at a distance using the remote control, make sure there is no one looking into the lens.
- Do not use the projector on a flammable surface (such as a newspaper, plastic sheet, or carpet) or an electric carpet. The high heat generated by the projector could deform or discolor them, resulting in a fire.
- During projection, do not touch the projector. The high heat generated by the projector lamp may cause a burn or injury.
- Do not place the projector on an unstable cart, stand, or table or on a surface that is unable to support its weight. Otherwise, it could fall or topple causing an accident and injury.
- Route any cords or cables so that they are out of the way; otherwise people may trip and fall or injure themselves.
- When using the projector outdoors at night, be careful not to trip over any extension power cords you are using. Otherwise, the projector could fall or topple causing an accident and injury.
- When installing the projector in a high position, take measures to prevent it from falling by using wires to ensure safety in an emergency, such as an earthquake, and to prevent accidents. If the projector is not installed correctly, the projector could fall. This may result in injury or accidents.
- Do not install in locations where salt damage could occur, or in locations subject to corrosive gas such as sulphuric gas from hot springs. Otherwise, corrosion could cause the projector to fall. It could also cause the projector to malfunction.
- Do not install the projector in locations exposed to high humidity and dust, such as on a kitchen counter, in the kitchen, or near a humidifier, or in locations exposed to oil smoke or steam. Doing so could cause fire or electric shock.
- Do not use the projector near water, sources of heat, high-voltage electrical wires, or sources of magnetic fields.
- Use the type of power source indicated on the projector. Use of a different power source may result in fire or electric shock. If you are not sure of the power available, consult your dealer or power company.
- Place the projector near a wall outlet where the plug can be easily unplugged.

- Take the following precautions when handling the plug: Do not hold the plug with wet hands. Do not insert the plug into a dusty outlet. Insert the plug firmly into the outlet. Do not pull the power cord when disconnecting the plug; always be sure to hold the plug when disconnecting it. Do not overload wall outlets, extension cords, or power strips. Failure to comply with these precautions could result in fire or electric shock.
- Do not place the projector where the cord can be walked on. This may result in fraying or damage to the plug.
- Unplug the projector from the wall outlet and allow to cool before cleaning. Use a dry cloth (or, for stubborn dirt or stains, a moist cloth that has been wrung dry) for cleaning. Do not use liquid or aerosol cleaners, any sprays containing flammable gas, or solvents such as alcohol, paint thinner, or benzine.
- Do not block the slots and openings in the projector case. They provide ventilation and prevent the projector from overheating. Do not operate the projector on a sofa, rug, or other soft surface, or set it on top of loose papers. Do not cover the projector with a blanket, curtain, or tablecloth. If you are setting up the projector near a wall, leave at least 7.9 inches (20 cm) of space between the wall and the projector. On the side where hot air is exhausted from the projector, leave at least 11.8 inches (30 cm) of space between the wall and the projector.
- Do not operate the projector in a closed-in cabinet unless proper ventilation is provided.
- Never allow objects of any kind to enter any openings in the projector. Do not leave objects, especially flammable objects, near the projector. Never spill liquid of any kind into the projector.
- You may need to clean the air vents. A clogged air vent can block ventilation needed to cool the projector. Do not use canned air, or the gases may leave a residue.
- Do not use or store the projector in locations where it will be subject to dust or dirt. Otherwise, the quality of the projected image may decline, or the air filter may become clogged, resulting in a malfunction or fire.
- Do not store the projector outdoors for an extended length of time.
- Except as specifically explained in this manual, do not attempt to service this product yourself. Refer all servicing to qualified personnel. Opening or removing covers may expose you to dangerous voltages and other hazards.
- Never open any covers on the projector except as specifically explained in this manual. Never attempt to disassemble or modify the projector. Refer all repairs to qualified service personnel.
- Unplug the projector from the wall outlet and refer servicing to qualified service personnel under the following conditions: if it does not operate normally when you follow the operating instructions, or exhibits a distinct change in performance; if smoke, strange odors, or strange noises come from the projector; if the power cord or plug is damaged or frayed; if liquid or foreign objects get inside the projector, or if it has been exposed to rain or water; if it has been dropped or the housing has been damaged.

- Do not touch the plug during an electrical storm. Otherwise, you may receive an electric shock.
- Unplug the projector when it will not be used for extended periods.
- Do not use the projector where it may be exposed to rain, water, or excessive humidity.
- Do not use or store the projector where it may be exposed to smoke, steam, corrosive gases, excessive dust, vibration, or shock.
- Do not use the projector where flammable or explosive gases may be present.
- Do not use or store the projector or remote control in a hot location, such as near a heater, in direct sunlight, or in a closed vehicle.
- If you use the projector in a country other than where you purchased it, use the correct power cord for that country.
- Do not stand on the projector or place heavy objects on it.
- If you are using the projector at altitudes above 4,921 feet (1,500 m), enable the **High Altitude Mode** setting in the projector's menu to ensure the projector's internal temperature is regulated properly.
- Do not use the projector outside of the required temperature range below:
Doing so may cause an unstable display and could lead to projector damage. Do not use or store the projector where it may be exposed to sudden changes in temperature.
- Do not store the projector outside of the required temperature range of 14 to 140 °F (–10 to 60 °C) or in direct sunlight for long periods of time. Doing so may cause damage to the case.
- Do not place anything that can become warped or damaged by heat near the exhaust vents. Do not bring your hands or face close to the vents while projection is in progress. Do not bring your face close to the projector while it is in use.
- Before you move the projector, make sure its power is turned off, the plug is disconnected from the outlet, and all cables are disconnected.
- Do not place the source of an open flame, such as a lit candle, on or near the projector.
- During projection, do not block the light from the projector with a book or other objects. If the light from the projector is blocked, the area on which the light shines becomes hot which could cause it to melt, burn, or start a fire. Also, the lens may get hot due to the reflected light which could cause the projector to malfunction. To stop projection, use the A/V Mute function, or turn off the projector.
- Do not modify the power cord. Do not place heavy objects on top of the power cord or bend, twist, or pull it excessively. Keep the power cord away from hot electrical appliances. Do not tie the power cord to other cables.
- If the lamp breaks, ventilate the area immediately, and contact a doctor if any fragments of broken glass are inhaled or get into the eyes or mouth

- Always lower the volume before turning off the projector. Turning on the projector with the volume too high can damage your ears. Gradually increase the volume after turning on the projector.
- A mercury lamp with high internal pressure is used as the projector's light source. If the lamp is subjected to vibrations or shocks, or if it is used for an overly extended length of time, the lamp may break or it may not turn on. If the lamp explodes, gases may escape and small fragments of glass may be scattered which could cause an injury. Be sure to observe the instructions below.
 - Do not bring your face close to the projector while it is in use.
 - Do not swing or tilt the projector. Shards of glass may fall out and could cause an injury. Be very careful not to allow such pieces of glass to enter your eyes or mouth.

Note:  The lamp(s) in this product contain mercury. Please consult your state and local regulations regarding disposal or recycling. Do not put in the trash.

[Restriction of Use](#)

Parent topic: [Notices](#)

Restriction of Use

When this product is used for applications requiring high reliability/safety such as transportation devices related to aviation, rail, marine, automotive; disaster prevention devices; various safety devices; or functional/precision devices, you should use this product only after giving consideration to including fail-safes and redundancies into your design to maintain safety and total system reliability.

Because this product was not intended for use in applications requiring extremely high reliability/safety such as aerospace equipment, main communication equipment, nuclear power control equipment, or medical equipment related to direct medical care, please make your own judgment on this product's suitability after a full evaluation.

Parent topic: [Important Safety Instructions](#)

Warning Labels

The product comes with the following warning label:

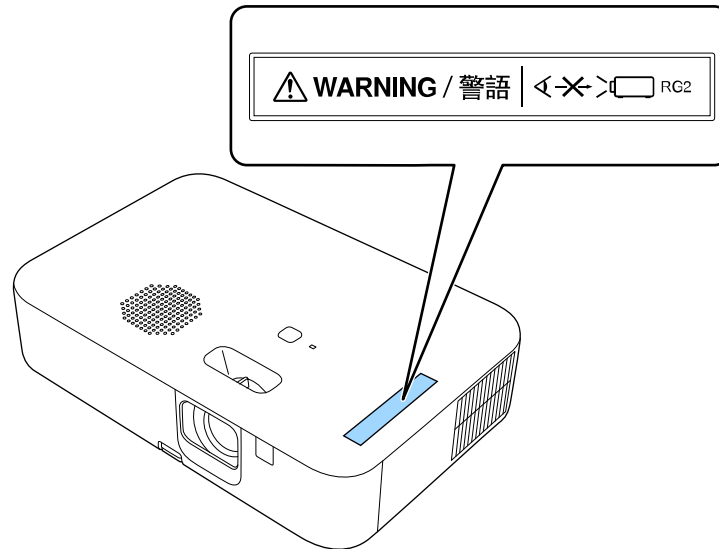









As with any bright source, do not stare into the beam, RG2 IEC/EN 62471-5:2015.







Parent topic: [Notices](#)







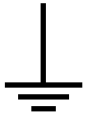

List of Safety Symbols







The following table lists the meaning of the safety symbols labeled on the equipment.

No.	Symbol	Approved Standards	Description
1		IEC60417 No.5007	"ON" (power) To indicate connection to the mains.

No.	Symbol	Approved Standards	Description
2		IEC60417 No.5008	"OFF" (power) To indicate disconnection from the mains.
3		IEC60417 No.5009	Stand-by To identify the switch or switch position by means of which part of the equipment is switched on in order to bring it into the stand-by condition.
4		ISO7000 No.0434B, IEC3864-B3.1	Caution To identify general caution when using the product.
5		IEC60417 No.5041	Caution, hot surface To indicate that the marked item can be hot and should not be touched without taking care.
6		IEC60417 No.6042 ISO3864-B3.6	Caution, risk of electric shock To identify equipment that has risk of electric shock.
7		IEC60417 No.5957	For indoor use only To identify electrical equipment designed primarily for indoor use.
8		IEC60417 No.5926	Polarity of DC power connector To identify the positive and negative connections (the polarity) on a piece of equipment to which a DC power supply may be connected.

No.	Symbol	Approved Standards	Description
9		—	Polarity of DC power connector To identify the positive and negative connections (the polarity) on a piece of equipment to which a DC power supply may be connected.
10		IEC60417 No.5001B	Battery, general On battery powered equipment. To identify a device for instance a cover for the battery compartment, or the connector terminals.
11		IEC60417 No.5002	Positioning of cell To identify the battery holder itself and to identify the positioning of the cell(s) inside the battery holder.
12		—	Positioning of cell To identify the battery holder itself and to identify the positioning of the cell(s) inside the battery holder.
13		IEC60417 No.5019	Protective earth To identify any terminal which is intended for connection to an external conductor for protection against electric shock in case of a fault, or the terminal of a protective earth electrode.
14		IEC60417 No.5017	Earth To identify an earth (ground) terminal in cases where neither the symbol No.13 is explicitly required.
15		IEC60417 No.5032	Alternating current To indicate on the rating plate that the equipment is suitable for alternating current only; to identify relevant terminals.

No.	Symbol	Approved Standards	Description
16		IEC60417 No.5031	Direct current To indicate on the rating plate that the equipment is suitable for direct current only; to identify relevant terminals.
17		IEC60417 No.5172	Class II equipment To identify equipment meeting the safety requirements specified for Class II equipment according to IEC 61140.
18		ISO 3864	General prohibition To identify actions or operations that are prohibited.
19		ISO 3864	Contact prohibition To indicate injury that could occur due to touching a specific part of the equipment.
20		—	Never look into the optical lens while the projector is on.
21		—	To indicate that the marked item don't place anything on projector.
22		ISO3864 IEC60825-1	Caution, laser radiation To indicate the equipment has a laser radiation part.
23		ISO 3864	Disassembly prohibition To indicate a risk of injury, such as electric shock, if the equipment is disassembled.

No.	Symbol	Approved Standards	Description
24		IEC60417 No. 5266	Standby, partial standby To indicate that part of the equipment is in the ready status.
25		ISO3864 IEC60417 No. 5057	Caution, movable parts To indicate that you must keep away from movable parts according to protection standards.
26		IEC60417 No. 6056	Caution, moving fan blades To indicate that you must keep away from moving fan blades.
27		IEC60417 No. 6043	Caution, sharp corners To indicate that you must not touch sharp corners.
28		—	To indicate that looking into the lens while projecting is prohibited.
29		ISO7010 No. W027 ISO3864	Warning, optical radiation (UV, visible light, IR, etc.) To indicate that you must be careful not to injure your eyes or skin when in the vicinity of optical radiation.
30		IEC60417 No. 5109	Not to be used in residential areas To indicate that the electrical equipment is not suitable for a residential area.

Parent topic: [Notices](#)

Wireless Safety Instructions

Wireless product safety instructions

Streaming Media Player model: STI6110B

Remote controller model: WH-5674 or WH-5674B

This document provides safety instructions and describes the specifications. Read this document carefully before use to ensure your safety and product performance. This device is restricted to indoor operations only.

Data transmission is always initiated by software, which is passed down through the MAC, through the digital and analog baseband, and finally to the RF chip. Several special packets are initiated by the MAC. These are the only ways the digital baseband portion will turn on the RF transmitter, which it then turns off at the end of the packet. Therefore, the transmitter will be on only while one of the aforementioned packets is being transmitted. In other words, this device automatically discontinues transmission in case of either absence of information to transmit or operational failure.

Parent topic: [Notices](#)

FCC Compliance Statement

U.S. FCC Notices

FCC ID: BKMAE-STI6110B

FCC ID: BKMAE-WH5674 or BKMAE-WH5674B

This device complies with Part 15 of the FCC Rules. Operation is subject to the following two conditions: (1) This device may not cause harmful interference, and (2) this device must accept any interference received, including interference that may cause undesired operation.

This equipment has been tested and found to comply with the limits for a Class B digital device, pursuant to Part 15 of the FCC Rules. These limits are designed to provide reasonable protection against harmful interference in a residential installation. This equipment generates, uses, and can radiate radio frequency energy and, if not installed and used in accordance with the instructions, may cause harmful interference to radio communications. However, there is no guarantee that interference will not occur in a particular installation. If this equipment does cause harmful interference to radio or television reception, which can be determined by turning the equipment off and on, the user is encouraged to try to correct the interference by one or more of the following measures:

- Reorient or relocate the receiving antenna.
- Increase the separation between the equipment and receiver.
- Connect the equipment into an outlet on a circuit different from that to which the receiver is connected.
- Consult the dealer or an experienced radio/TV technician for help.

Caution: Changes or modifications not expressly approved by the party responsible for compliance could void the user's authority to operate this equipment. Properly shielded and grounded cables and

connectors must be used for connection to host computers and/ or peripherals in order to meet FCC emission limits.

This transmitter must not be co-located or operating in conjunction with any other antenna or transmitter.

This equipment complies with FCC radiation exposure limits set forth for an uncontrolled environment and meets the FCC radio frequency (RF) Exposure Guidelines. This equipment should be installed and operated with a distance of at least 7.9 inches (20 cm) between the radiator and your body (except for the Bluetooth remote controller model WH-5674 or WH-5674B).

Industry Canada (IC) Notices

IC: 1052D-STI6110B

IC: 1052D-WH5674 or 1052D-WH5674B

CAN ICES-3 (B)/NMB-3 (B)

This device complies with Industry Canada's license-exempt RSSs. Operation is subject to the following two conditions: (1) This device may not cause interference; and (2) this device must accept any interference, including interference that may cause undesired operation of the device.

This equipment complies with IC radiation exposure limits set forth for an uncontrolled environment and meets RSS-102 of the IC radio frequency (RF) Exposure rules. This equipment should be installed and operated with a distance of at least 7.9 inches (20 cm) between the radiator and your body (except for the Bluetooth remote controller model WH-5674 or WH-5674B).

Parent topic: [Notices](#)

Binding Arbitration and Class Waiver

1. DISPUTES, BINDING INDIVIDUAL ARBITRATION, AND WAIVER OF CLASS ACTIONS AND CLASS ARBITRATIONS

1.1 Disputes. The terms of this Section 1 shall apply to all Disputes between you and Epson. The term "Dispute" is meant to have the broadest meaning permissible under law and includes any dispute, claim, controversy or action between you and Epson arising out of or relating to this Agreement, Epson branded products (hardware and including any related software), or other transaction involving you and Epson, whether in contract, warranty, misrepresentation, fraud, tort, intentional tort, statute, regulation, ordinance, or any other legal or equitable basis. "DISPUTE" DOES NOT INCLUDE IP CLAIMS, or more specifically, a claim or cause of action for (a) trademark infringement or dilution, (b) patent infringement, (c) copyright infringement or misuse, or (d) trade secret misappropriation (an "IP Claim"). You and Epson also agree, notwithstanding Section 1.6, that a court, not an arbitrator, may decide if a claim or cause of action is for an IP Claim.

1.2 Binding Arbitration. You and Epson agree that all Disputes shall be resolved by binding arbitration according to this Agreement. **ARBITRATION MEANS THAT YOU WAIVE YOUR RIGHT TO A JUDGE OR JURY IN A COURT PROCEEDING AND YOUR GROUNDS FOR APPEAL ARE LIMITED.**

Pursuant to this Agreement, binding arbitration shall be administered by JAMS, a nationally recognized arbitration authority, pursuant to its code of procedures then in effect for consumer related disputes, but excluding any rules that permit joinder or class actions in arbitration (for more detail on procedure, see Section 1.6 below). You and Epson understand and agree that (a) the Federal Arbitration Act (9 U.S.C. §1, et seq.) governs the interpretation and enforcement of this Section 1, (b) this Agreement memorializes a transaction in interstate commerce, and (c) this Section 1 shall survive termination of this Agreement.

1.3 Pre-Arbitration Steps and Notice. Before submitting a claim for arbitration, you and Epson agree to try, for sixty (60) days, to resolve any Dispute informally. If Epson and you do not reach an agreement to resolve the Dispute within the sixty (60) days, you or Epson may commence an arbitration. Notice to Epson must be addressed to: Epson America, Inc., ATTN: Legal Department, 3131 Katella Ave., Los Alamitos, CA 90720 (the "Epson Address"). The Dispute Notice to you will be sent to the most recent address Epson has in its records for you. For this reason, it is important to notify us if your address changes by emailing us at EAlegal@ea.epson.com or writing us at the Epson Address above. Notice of the Dispute shall include the sender's name, address and contact information, the facts giving rise to the Dispute, and the relief requested (the "Dispute Notice"). Following receipt of the Dispute Notice, Epson and you agree to act in good faith to resolve the Dispute before commencing arbitration.

1.4 Small Claims Court. Notwithstanding the foregoing, you may bring an individual action in the small claims court of your state or municipality if the action is within that court's jurisdiction and is pending only in that court.

1.5 WAIVER OF CLASS ACTIONS AND CLASS ARBITRATIONS. YOU AND EPSON AGREE THAT EACH PARTY MAY BRING DISPUTES AGAINST THE OTHER PARTY ONLY IN AN INDIVIDUAL CAPACITY, AND NOT AS A PLAINTIFF OR CLASS MEMBER IN ANY CLASS OR REPRESENTATIVE PROCEEDING, INCLUDING WITHOUT LIMITATION FEDERAL OR STATE CLASS ACTIONS, OR CLASS ARBITRATIONS. CLASS ACTION LAWSUITS, CLASS-WIDE ARBITRATIONS, PRIVATE ATTORNEY-GENERAL ACTIONS, AND ANY OTHER PROCEEDING WHERE SOMEONE ACTS IN A REPRESENTATIVE CAPACITY ARE NOT ALLOWED. ACCORDINGLY, UNDER THE ARBITRATION PROCEDURES OUTLINED IN THIS SECTION, AN ARBITRATOR SHALL NOT COMBINE OR CONSOLIDATE MORE THAN ONE PARTY'S CLAIMS WITHOUT THE WRITTEN CONSENT OF ALL AFFECTED PARTIES TO AN ARBITRATION PROCEEDING.

1.6 Arbitration Procedure. If you or Epson commences arbitration, the arbitration shall be governed by the rules of JAMS that are in effect when the arbitration is filed, excluding any rules that permit arbitration on a class or representative basis (the "JAMS Rules"), available at <http://www.jamsadr.com> or by calling 1-800-352-5267 (U.S. or Canada), or <https://www.jamsadr.com/about/> or by calling +1-949-224-1810 (Latin America), and under the rules set forth in this Agreement. All Disputes shall be resolved by a

single neutral arbitrator, and both parties shall have a reasonable opportunity to participate in the selection of the arbitrator. The arbitrator is bound by the terms of this Agreement. The arbitrator, and not any federal, state or local court or agency, shall have exclusive authority to resolve all disputes arising out of or relating to the interpretation, applicability, enforceability or formation of this Agreement, including any claim that all or any part of this Agreement is void or voidable. Notwithstanding this broad delegation of authority to the arbitrator, a court may determine the limited question of whether a claim or cause of action is for an IP Claim, which is excluded from the definition of "Disputes" in Section 1.1 above. The arbitrator shall be empowered to grant whatever relief would be available in a court under law or in equity. The arbitrator may award you the same damages as a court could, and may award declaratory or injunctive relief only in favor of the individual party seeking relief and only to the extent necessary to provide relief warranted by that party's individual claim. In some instances, the costs of arbitration can exceed the costs of litigation and the right to discovery may be more limited in arbitration than in court. The arbitrator's award is binding and may be entered as a judgment in any court of competent jurisdiction.

You may choose to engage in arbitration hearings by telephone. Arbitration hearings not conducted by telephone shall take place in a location reasonably accessible from your primary residence, or in Orange County, California, at your option.

a) Initiation of Arbitration Proceeding. If either you or Epson decides to arbitrate a Dispute, both parties agree to the following procedure:

(i) Write a Demand for Arbitration. The demand must include a description of the Dispute and the amount of damages sought to be recovered. You can find a copy of a Demand for Arbitration at <http://www.jamsadr.com> ("Demand for Arbitration").

(ii) Send three copies of the Demand for Arbitration, plus the appropriate filing fee, to: JAMS, 500 North State College Blvd., Suite 600 Orange, CA 92868, U.S.A.

(iii) Send one copy of the Demand for Arbitration to the other party (same address as the Dispute Notice), or as otherwise agreed by the parties.

b) Hearing Format. During the arbitration, the amount of any settlement offer made shall not be disclosed to the arbitrator until after the arbitrator determines the amount, if any, to which you or Epson is entitled. The discovery or exchange of non-privileged information relevant to the Dispute may be allowed during the arbitration.

c) Arbitration Fees. Epson shall pay, or (if applicable) reimburse you for, all JAMS filings and arbitrator fees for any arbitration commenced (by you or Epson) pursuant to provisions of this Agreement.

d) Award in Your Favor. For Disputes in which you or Epson seeks \$75,000 or less in damages exclusive of attorney's fees and costs, if the arbitrator's decision results in an award to you in an amount greater than Epson's last written offer, if any, to settle the Dispute, Epson will: (i) pay you \$1,000 or the amount of the award, whichever is greater; (ii) pay you twice the amount of your reasonable attorney's fees, if any; and (iii) reimburse you for any expenses (including expert witness fees and costs) that your attorney

reasonably accrues for investigating, preparing, and pursuing the Dispute in arbitration. Except as agreed upon by you and Epson in writing, the arbitrator shall determine the amount of fees, costs, and expenses to be paid by Epson pursuant to this Section 1.6d).

e) Attorney's Fees. Epson will not seek its attorney's fees and expenses for any arbitration commenced involving a Dispute under this Agreement. Your right to attorney's fees and expenses under Section 1.6d) above does not limit your rights to attorney's fees and expenses under applicable law; notwithstanding the foregoing, the arbitrator may not award duplicative awards of attorney's fees and expenses.

1.7 Opt-out. You may elect to opt-out (exclude yourself) from the final, binding, individual arbitration procedure and waiver of class and representative proceedings specified in this Agreement by sending a written letter to the Epson Address within thirty (30) days of your assent to this Agreement (including without limitation the purchase, download, installation of the Software or other applicable use of Epson Hardware, products and services) that specifies (i) your name, (ii) your mailing address, and (iii) your request to be excluded from the final, binding individual arbitration procedure and waiver of class and representative proceedings specified in this Section 1. In the event that you opt-out consistent with the procedure set forth above, all other terms shall continue to apply, including the requirement to provide notice prior to litigation.

1.8 Amendments to Section 1. Notwithstanding any provision in this Agreement to the contrary, you and Epson agree that if Epson makes any future amendments to the dispute resolution procedure and class action waiver provisions (other than a change to Epson's address) in this Agreement, Epson will obtain your affirmative assent to the applicable amendment. If you do not affirmatively assent to the applicable amendment, you are agreeing that you will arbitrate any Dispute between the parties in accordance with the language of this Section 1 (or resolve disputes as provided for in Section 1.7, if you timely elected to opt-out when you first assented to this Agreement).

1.9 Severability. If any provision in this Section 1 is found to be unenforceable, that provision shall be severed with the remainder of this Agreement remaining in full force and effect. **The foregoing shall not apply to the prohibition against class or representative actions as provided in Section 1.5. This means that if Section 1.5 is found to be unenforceable, the entire Section 1 (but only Section 1) shall be null and void.**

Parent topic: [Notices](#)

Trademarks

EPSON® and Quick Corner® are registered trademarks and EPSON Exceed Your Vision is a registered logomark of Seiko Epson Corporation.

Microsoft, Windows, and the Windows logo are trademarks or registered trademarks of Microsoft Corporation in the United States and/or other countries.

Mac, OS X, iOS, and macOS are trademarks of Apple Inc.

Google, Google Assistant, Google Home, Google Play, YouTube, Chromecast, and Android TV are trademarks of Google LLC.

Google Assistant is not available in certain languages and countries. Availability of services varies by country and language.

Netflix is a registered trademark of Netflix, Inc.

The Bluetooth® word mark and logo are registered trademarks of Bluetooth SIG, Inc., and the Seiko Epson Corporation uses these marks under license.

General Notice: Other product names used herein are for identification purposes only and may be trademarks of their respective owners. Epson disclaims any and all rights in those marks.



Parent topic: [Notices](#)

Copyright Notice

All rights reserved. No part of this publication may be reproduced, stored in a retrieval system, or transmitted in any form or by any means, electronic, mechanical, photocopying, recording, or otherwise, without the prior written permission of Seiko Epson Corporation. The information contained herein is designed only for use with this Epson product. Epson is not responsible for any use of this information as applied to other products.

Neither Seiko Epson Corporation nor its affiliates shall be liable to the purchaser of this product or third parties for damages, losses, costs, or expenses incurred by purchaser or third parties as a result of: accident, misuse, or abuse of this product or unauthorized modifications, repairs, or alterations to this product, or (excluding the U.S.) failure to strictly comply with Seiko Epson Corporation's operating and maintenance instructions.

Seiko Epson Corporation shall not be liable for any damages or problems arising from the use of any options or any consumable products other than those designated as Original Epson Products or Epson Approved Products by Seiko Epson Corporation.

This information is subject to change without notice.

[A Note Concerning Responsible Use of Copyrighted Materials](#)
[Copyright Attribution](#)

Parent topic: [Notices](#)

A Note Concerning Responsible Use of Copyrighted Materials

Epson encourages each user to be responsible and respectful of the copyright laws when using any Epson product. While some countries' laws permit limited copying or reuse of copyrighted material in certain circumstances, those circumstances may not be as broad as some people assume. Contact your legal advisor for any questions regarding copyright law.

Parent topic: [Copyright Notice](#)

Copyright Attribution

© 2022 Epson America, Inc.

9/22

CPD-62252

Parent topic: [Copyright Notice](#)