



# 3-16kVA Service Bypass Panels

©2009 APC by Schneider Electric, APC, the APC logo, and Smart-UPS are owned by Schneider Electric industries S.A.S American Power Conversion Corporation, or their affiliated companies. All other trademarks are property of their respective owners.

990-1530B

Note: Read the safety information sheet before installation.

Illustrations in this document may differ slightly from the actual hardware.

**Attention: This product is for use in a controlled environment. Refer to product specifications for environmental limits.**

## RACK MOUNTING

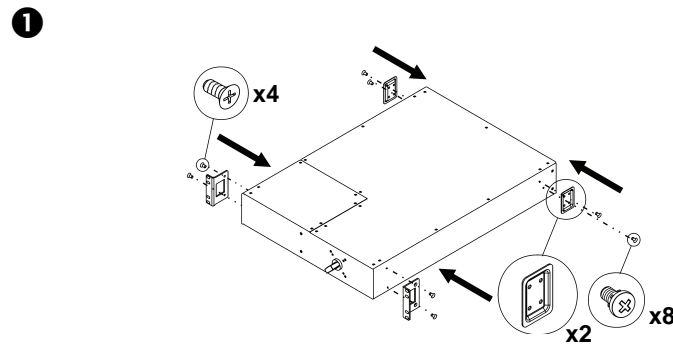

**2** Set SBP in the rack. If hardwiring is required, see *Connecting Power* section before screwing into the rack.

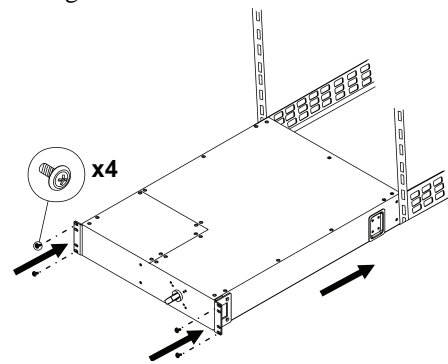

## WALL MOUNTING

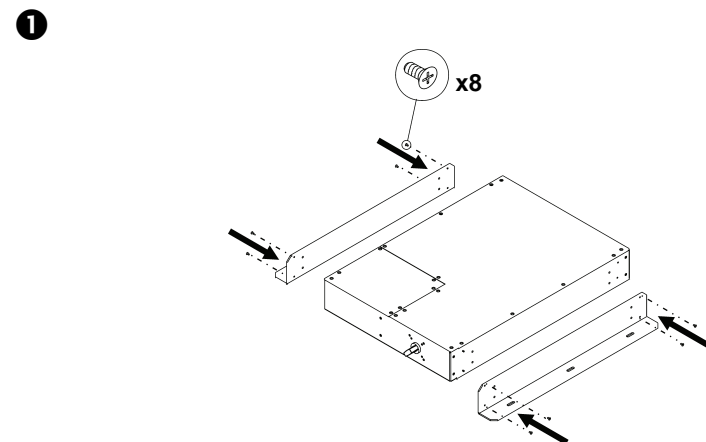

**2** Whenever possible, attach one top screw and one bottom screw into a wall stud. If stud mounting is not possible, use an expandable wall anchor. **Screws are not included;** .25" x 2" lag bolts are recommended.

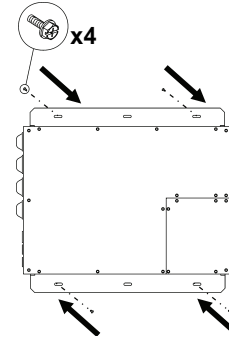

## TOWER OPTION (FOR SMART-UPS RT SETUPS ONLY)

**1** Remove screw from the top and bottom rear of both the UPS and SBP. Install tie brackets and reattach screws.

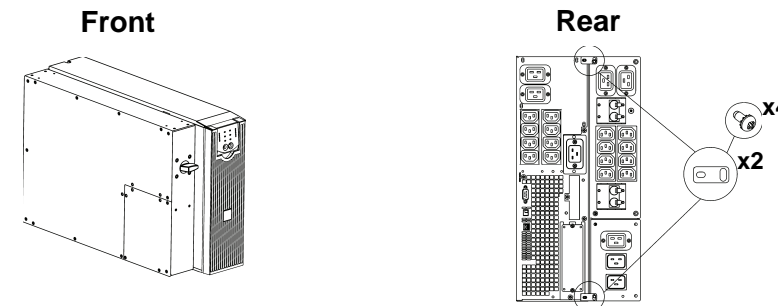

**2** Unscrew and remove top cover of the UPS.

**3** Attach bracket to top of UPS and SBP.

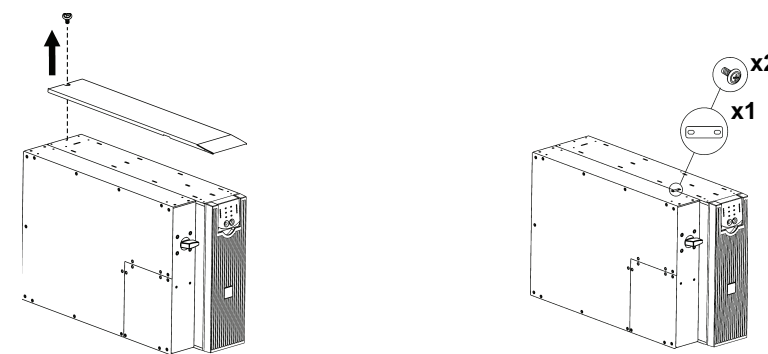

**4** Reattach top cover of the UPS.

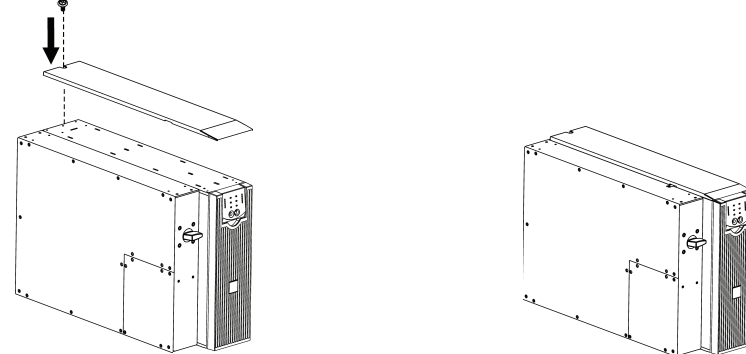

Note: The SBP5000RMI2U, when used in conjunction with an SURT3000XLI or SURT5000XLI UPS in a tower configuration without an external battery pack (SURT192XLBP), is suitable for mounting on concrete or other non-combustible smooth surfaces only.

## USER CONFIGURABLE

**Attention: When using an online UPS, put the UPS in automatic bypass mode before rotating the SBP switch.**

**1. Normal:** Power is directed from the utility outlet, through the Bypass Panel and UPS, and to connected equipment. For use during normal UPS operation.

**2. Test:** Power supplied to the UPS is not output. Use when tests are being conducted on the UPS, and connected equipment is not yet desired.

**3. Bypass:** Power from the utility outlet is filtered through the Bypass Panel, and to the connected equipment. Use to bypass the UPS, when functioning improperly.

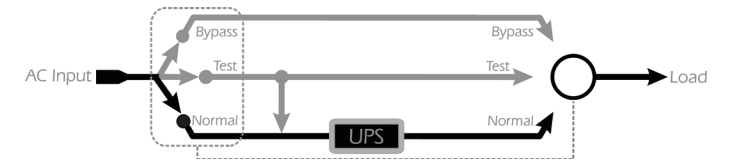

Note: While operating in "Test" or "Bypass" mode, power to the connected equipment is not conditioned by the UPS. At this time, the "Equipment Protection Policy" is not valid.

## IDENTIFYING THE PANEL

Service Bypass Panels will differ. Refer to chart for unit specifications.

Note: HW= Hardwire

Service Bypass Panel	Corresponding UPS Systems	Bypass Input	UPS Input	UPS Output	PDU Panel
SBP3000RM2U	100-120V Smart-UPS 3kVA	L5-30P	L5-30R	L5-30P	(2) 5-20R, (6) 5-15R
SBP5000RMT2U	200/208/240V Smart-UPS 3-4.5kVA	L6-30P	L6-30R	L6-30P	(2) L6-20R, (2) L6-30R
SBP5000RMI2U*	230V Smart-UPS 3-5kVA	C20/HW	C19/HW	C20/HW	(2) C19, (8) C13
SBP6KRMT2U**	200/208/240V Symmetra 2-6kVA	L6-30P/ HW	L6-30R/ HW	L6-30P/ HW	(1) L6-20R, (2) L6-30R
SBP6KRMI2U	230V Symmetra 2-6kVA	HW	HW	HW	(4) C19
SBP3000	100-240V Smart-UPS 3-5kVA with 30A HW input/output available	HW	HW	HW	HW
SBP10KRMT4U	200/208/240V Smart-UPS RT 7.5-10kVA	HW	HW	HW	(3) L6-20R, (3) L6-30R
SBP10KRMI4U	230V Smart-UPS RT 7.5-10kVA	HW (3Ph or 1Ph)	HW (3Ph or 1Ph)	HW	(8) C13, (2) C19
SBP16KP	200-240V Symmetra LX 4-16kVA	HW (3Ph or 1Ph)	HW (3Ph or 1Ph)	HW	HW
SBP16KRMI4U	220-240V Symmetra LX 4-16kVA	HW (3Ph or 1Ph)	HW (3Ph or 1Ph)	HW	(3) 30A HW
SBP16KRMP4U	200/208/240 Symmetra LX 4-16kVA	HW	HW	HW	(6) L14-30R
SBP16KRMP4U-HW	200/208/240 Symmetra LX 4-16kVA	HW	HW	HW	(1) L14-30R, (3) L5-20R, (1) 100A HW

\*For loads exceeding 3kVA, hardwiring is necessary.

\*\*For loads exceeding 5kVA, hardwiring is necessary.

## CONNECTING POWER

**Warning: Do not modify inlets or outlets. The SBP and UPS plugs and receptacles should match. For more information, contact APC.**

### 1. Non-Hardwired Panels

1. Plug SBP UPS output cord into UPS PDU panel.\*
2. Plug UPS input cord to SBP UPS input receptacle.\*
3. Plug customer equipment into SBP PDU panel.
4. Plug SBP into utility power outlet.

\*Units with IEC receptacles: Use jumper cables.

### 2. Hardwired Panels

**Attention: Wiring must be performed by a qualified electrician.**

1. Switch input circuit breaker off.
2. *SBP units that will be rack-mounted:* Set SBP in the rack.
3. Unscrew and remove top access panel.
4. *If using SBP5000RMI2U or SBP6KRMT2U with a hardwired UPS:* Unscrew existing terminal block wiring. Do not touch factory wiring (see **E**).
5. *If using SBP5000RMI2U or SBP6KRMT2U with a hardwired UPS:* Unscrew and remove rear input/output panel.
6. Remove circular knockouts from hardwiring input/output panel (see **A, B, C, D**: UO= UPS Output; UI= UPS Input; AI= AC Input; LD= Load).  
*SBP3000 units:* Also, remove PDU output panel knockout plate.  
*SBP16KP units:* Also, remove circular knockouts from PDU output panel.
7. Connect wires to terminal blocks (see **E, F, G, H, I**). Adhere to all national and local electrical codes.
8. Reinstall access panel.
9. Install hardwiring input/output panel.
10. *SBP units that will be rack-mounted:* Screw SBP into the rack.

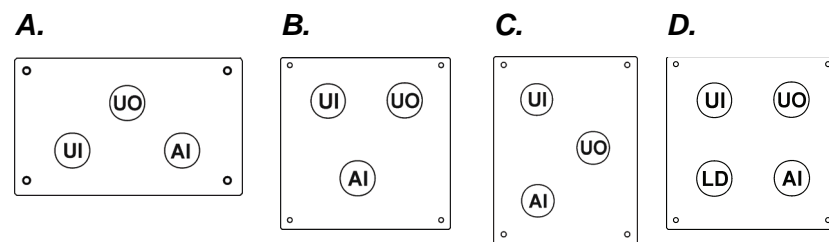

### E. 2U PANELS

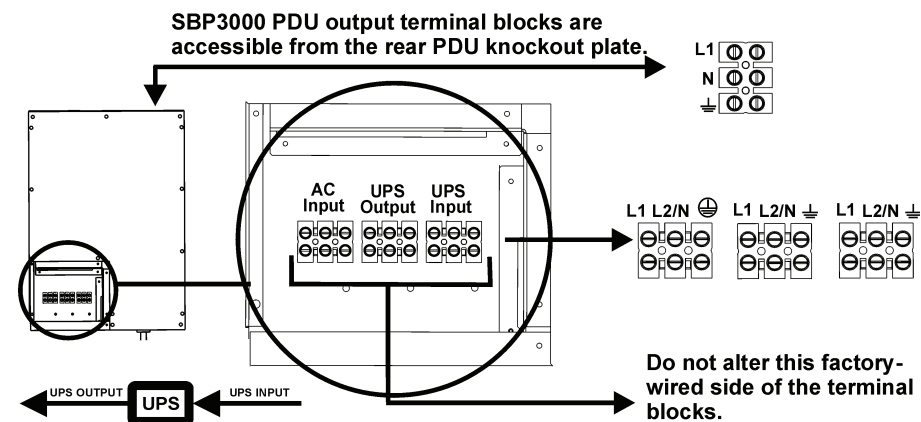

### F. SBP10KRMT4U

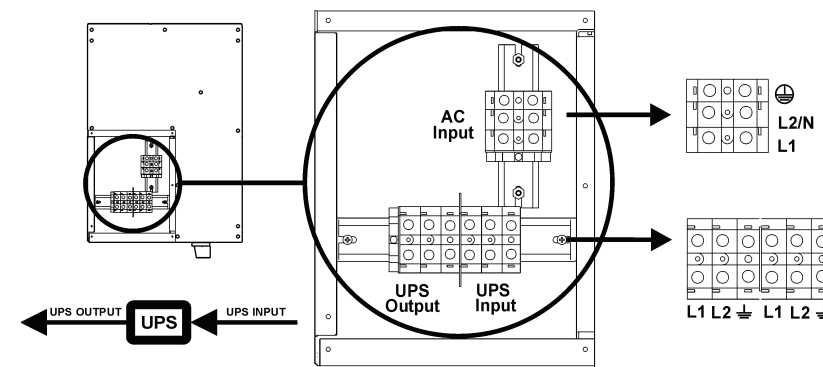

### G. SBP16KRMP4U, SB16KRMP4U-HW

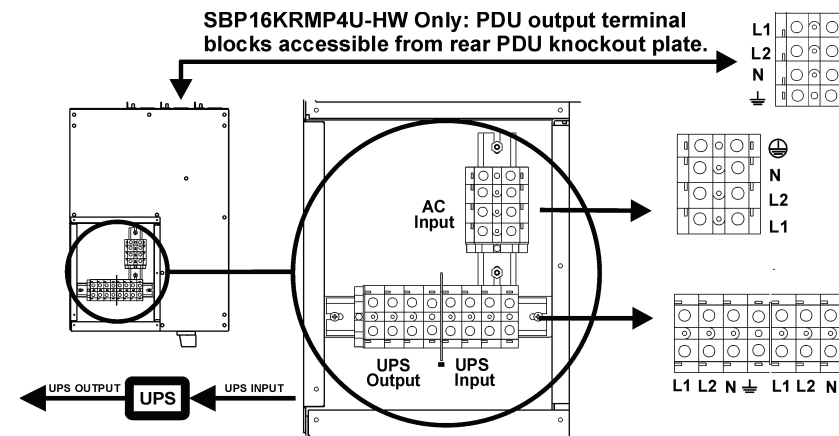

### H. SBP16KP

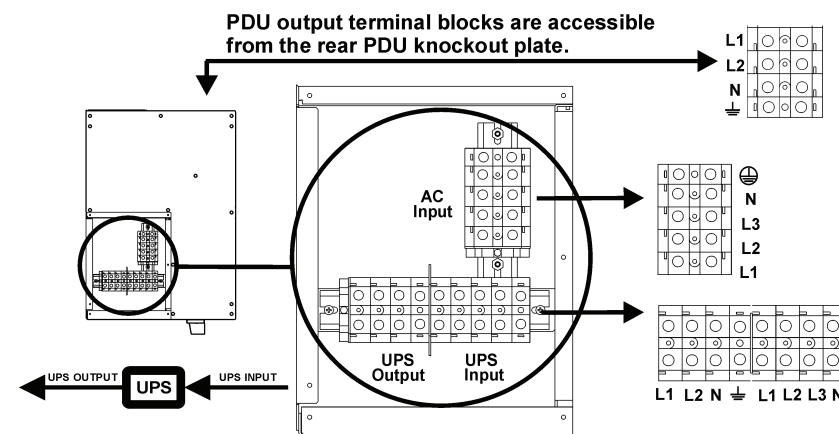

### I. SBP10KRMI4U, SBP16KRMI4U

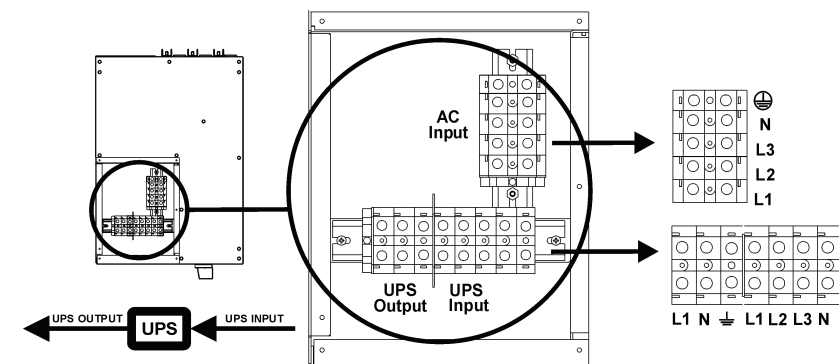

## TROUBLESHOOTING

Use the chart below to solve minor SBP installation problems. Also, refer to the UPS User Manual *Troubleshooting* section. For more complex issues, refer to [www.apc.com](http://www.apc.com).

Problem and Possible Cause	Solution
<b>UPS WILL NOT TURN ON AFTER ON BUTTON IS PUSHED</b>	
SBP handle is in 'Bypass' position.	Rotate the SBP handle to the 'Normal' position.
There is no power at UPS input.	Check that the power cables from the SBP to the utility power, and from the SBP to the UPS Input are securely connected.
UPS is faulty or damaged.	Rotate the SBP handle into the 'Test' position. If the connected equipment becomes energized, the UPS may be faulty. To confirm this, refer to UPS User Manual <i>Troubleshooting</i> .
There is no power at the utility power outlet.	Rotate the SBP handle into the 'Test' position. If the connected equipment fails to become energized, the utility power outlet may be faulty. Check the utility power supply by plugging a table lamp into the suspect outlet. If the utility outlet fails to power the lamp, contact qualified service personnel to restore power.
<b>UPS IS ONLINE; NOT POWERING ALL CONNECTED EQUIPMENT</b>	
SBP output circuit breaker tripped.	Reduce the load by unplugging equipment. Reset the breaker.
There is no power at SBP output.	Check that the power cable from the SBP to the UPS output is securely connected.

## REGULATORY INFORMATION