

---

# INSTALLATION INSTRUCTIONS

---

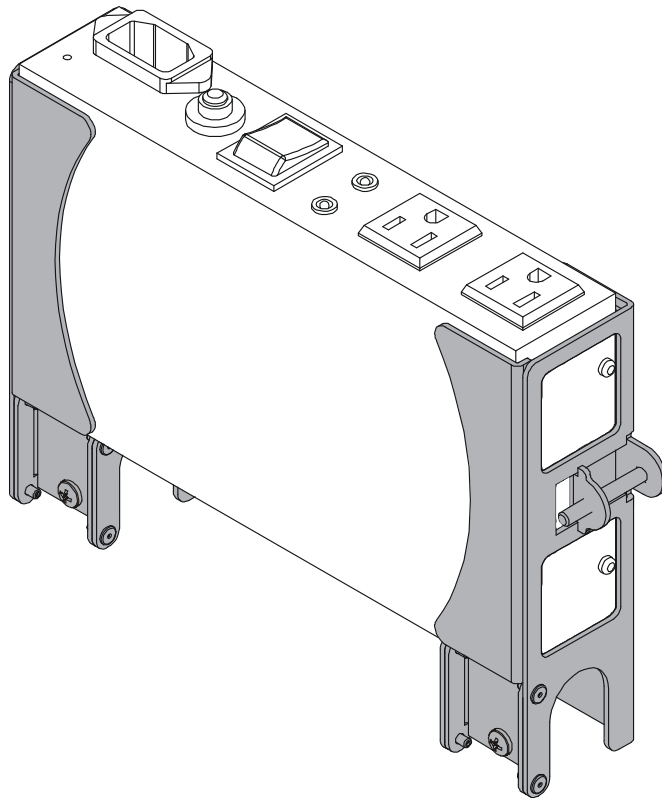

---

## Fusion Universal CPU Accessory

---

## DISCLAIMER

Milestone AV Technologies and its affiliated corporations and subsidiaries (collectively "Milestone"), intend to make this manual accurate and complete. However, Milestone makes no claim that the information contained herein covers all details, conditions or variations, nor does it provide for every possible contingency in connection with the installation or use of this product. The information contained in this document is subject to change without notice or obligation of any kind. Milestone makes no representation of warranty, expressed or implied, regarding the information contained herein. Milestone assumes no responsibility for accuracy, completeness or sufficiency of the information contained in this document.

Chief® is a registered trademark of Milestone AV Technologies. All rights reserved.

## IMPORTANT SAFETY INSTRUCTIONS

 **WARNING:** A WARNING alerts you to the possibility of serious injury or death if you do not follow the instructions.

 **CAUTION:** A CAUTION alerts you to the possibility of damage or destruction of equipment if you do not follow the corresponding instructions.

 **WARNING:** Failure to read, thoroughly understand, and follow all instructions can result in serious personal injury, damage to equipment, or voiding of factory warranty! It is the installer's responsibility to make sure all components are properly assembled and installed using the instructions provided.

 **WARNING:** Failure to provide adequate structural strength for this component can result in serious personal injury or damage to equipment! It is the installer's responsibility to make sure the structure to which this component is attached can support five times the combined weight of all equipment. Reinforce the structure as required before installing the component. The wall to which the mount is being attached may have a maximum drywall thickness of 5/8" (1.6cm).

 **WARNING:** Exceeding the weight capacity can result in serious personal injury or damage to equipment! It is the installer's responsibility to make sure the combined weight of all components located on the FCA112 does not exceed 15 lbs (6.8 kg).

 **WARNING:** RISK OF INJURY TO PERSONS! Do not use this mounting system to support video equipment such as televisions or computer monitors.

 **WARNING:** Use this mounting system only for its intended use as described in these instructions. Do not use attachments not recommended by the manufacturer.

 **WARNING:** Never operate this mounting system if it is damaged. Return the mounting system to a service center for examination and repair.



 **WARNING:** Do not use this product outdoors.

**--SAVE THESE INSTRUCTIONS--**

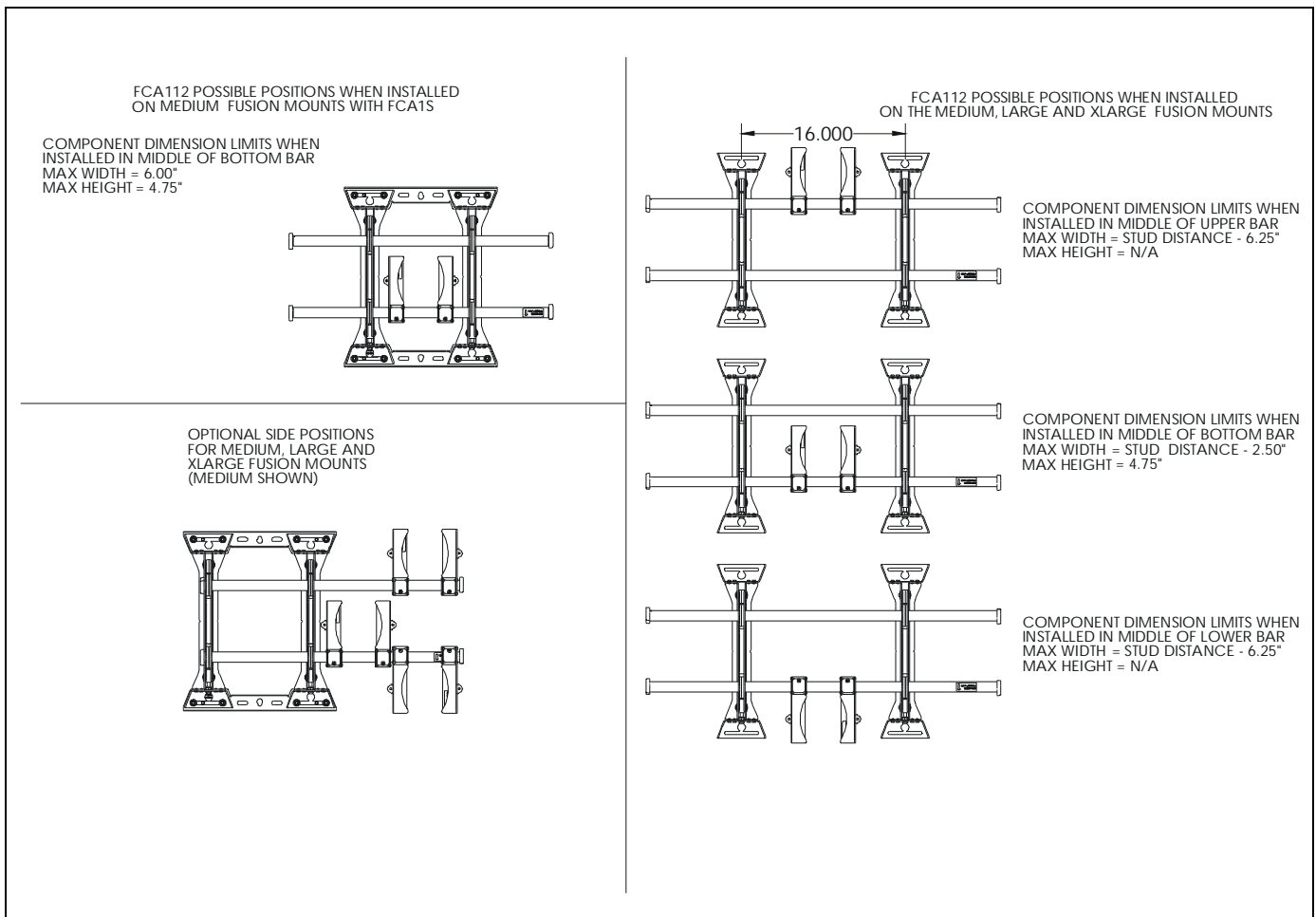
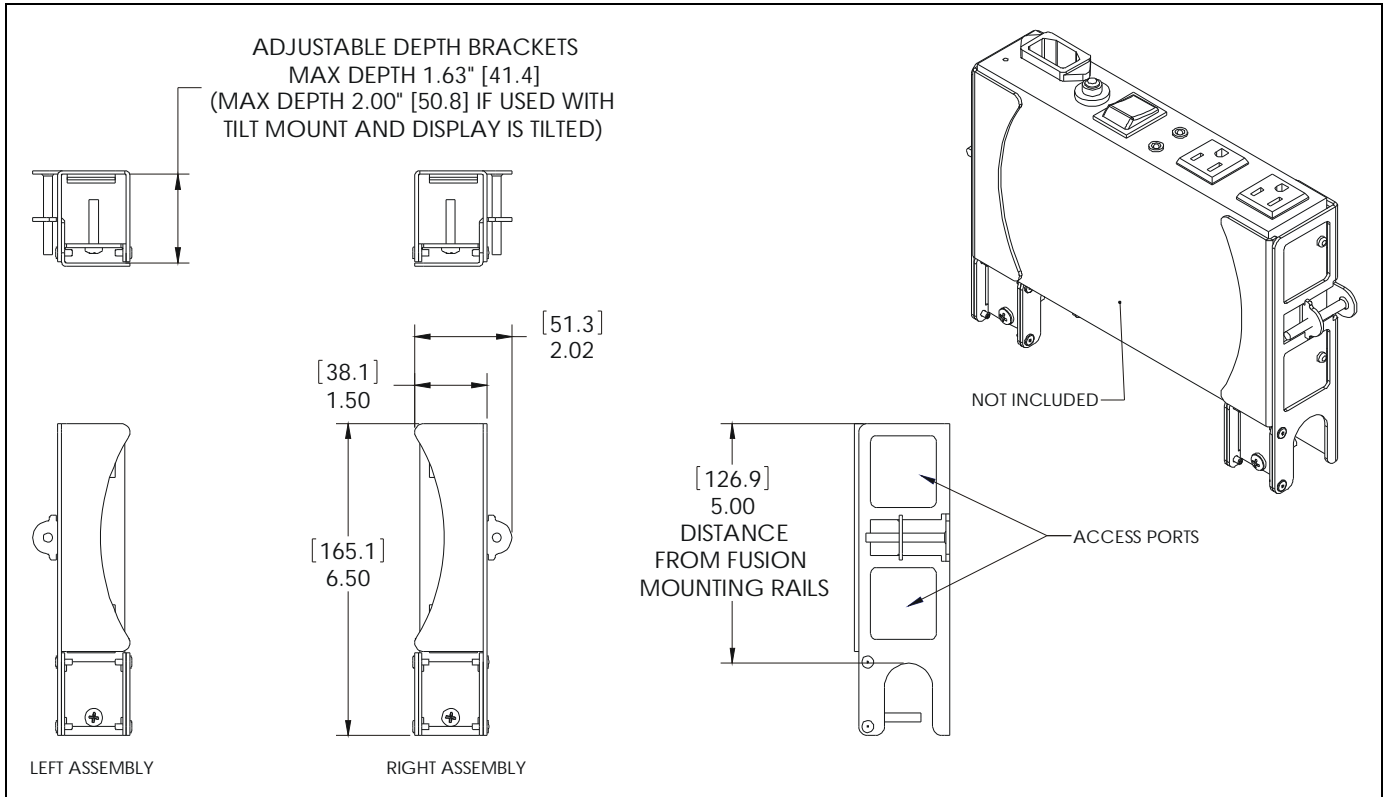
**DIMENSIONS**



**LEGEND**

	<b>By Hand</b>		<b>Phillips Screwdriver</b>
	A mano		Destornillador Phillips
	Von Hand		Kreuzschlitzschraubendreher
	Com a mão		Chave de fendas Phillips
	A mano		Cacciavite a stella
	Met de hand		Kruiskopschroevendraaier
À la main	Tournevis à pointe cruciforme		

**TOOLS REQUIRED FOR INSTALLATION**

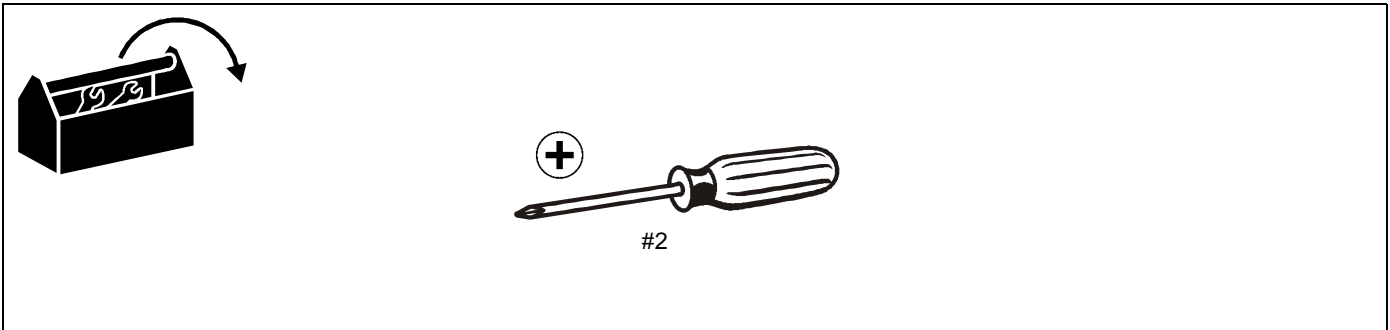

**PARTS**

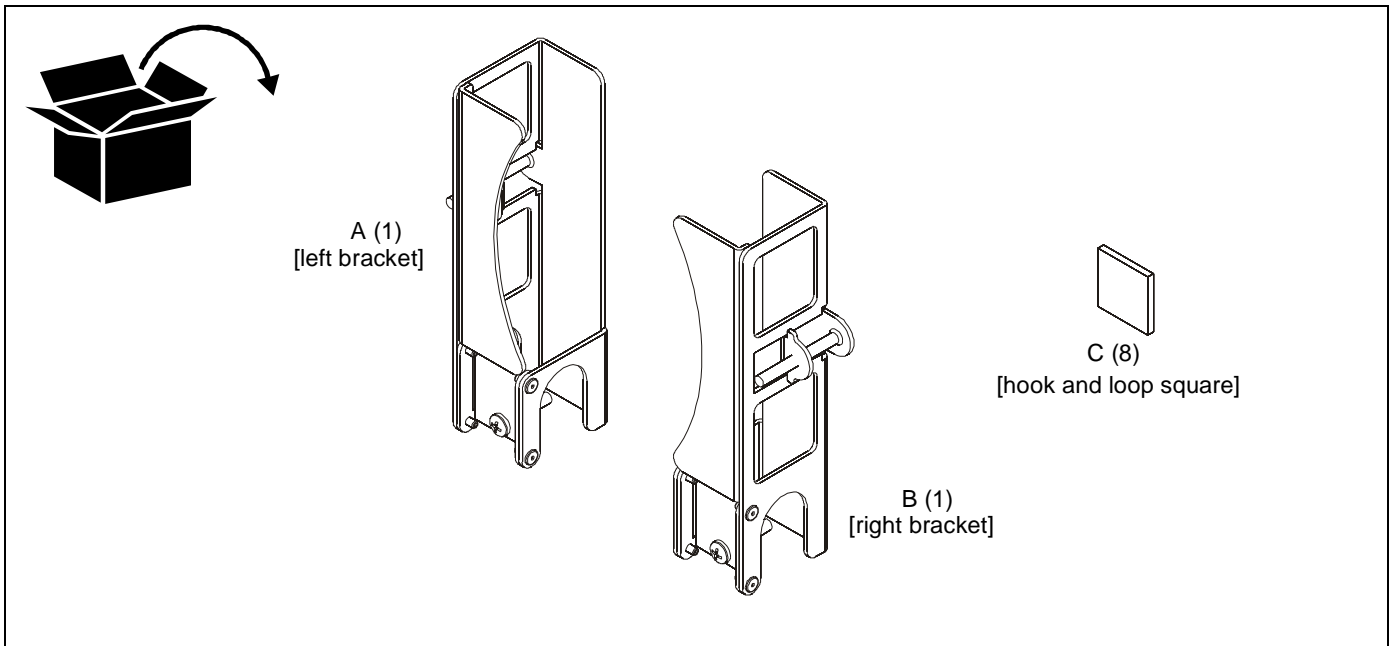

## INSTALLATION

**NOTE:** The FCA112 may be used to support a surge adapter or other components that don't exceed the weight capacity of the FCA112.

1. Put hook and loop squares (C) together so there are 4 squares of hook and loop.
2. Remove paper from one side of each of the four hook and loop squares.
3. Attach hook and loop squares to the left and right brackets (A and B). (See Figure 1)

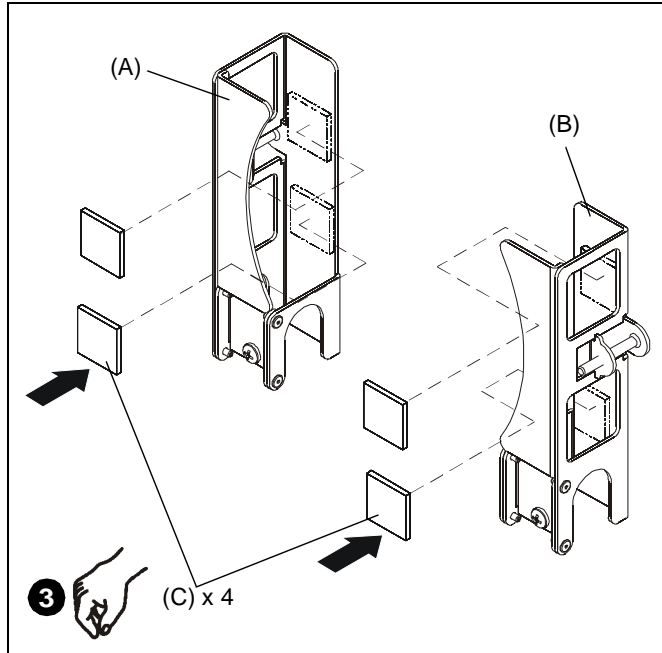

**Figure 1**

4. Remove paper from hook and loop squares, lower and press the surge adapter, or other component, against the left and right brackets. (See Figure 2)
5. Rest the surge adapter on the inside legs of the brackets. (See Figure 2)

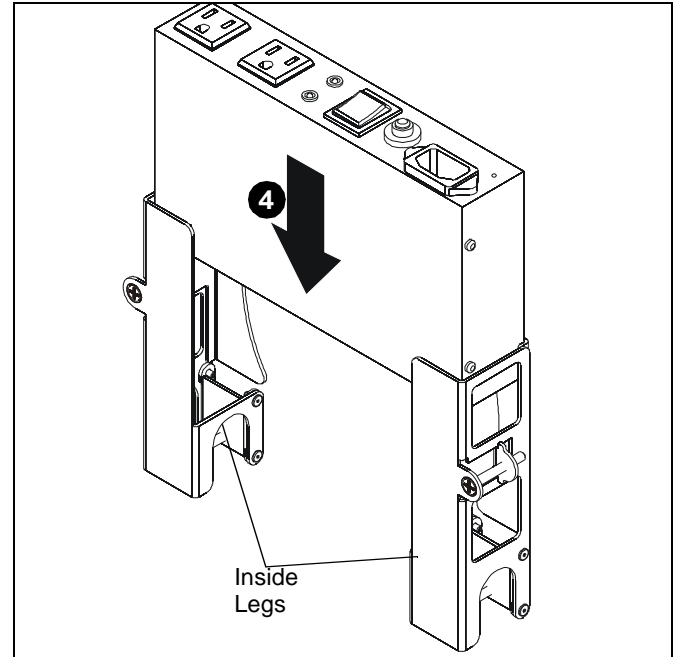

**Figure 2**

6. Tighten the brackets against the surge adapter by tightening the Phillips flat machine screws with Phillips screwdriver. (See Figure 3)

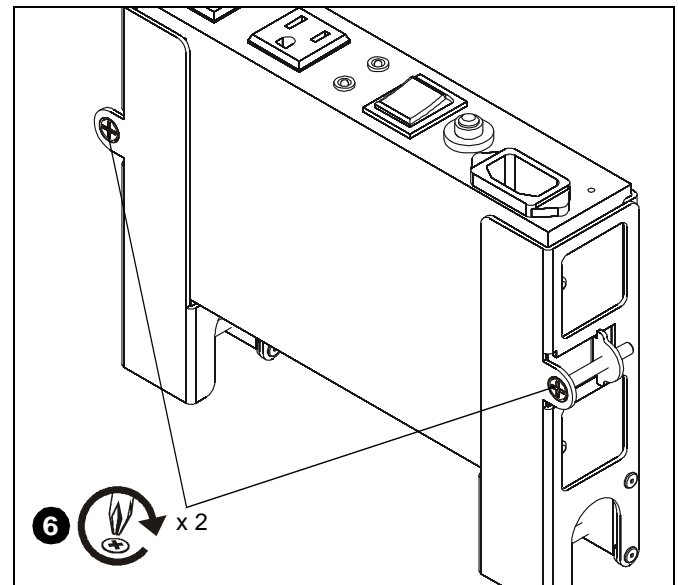

**Figure 3**

7. Place the left and right brackets with the surge adapter onto the wall mount.

**NOTE:** The brackets may be placed in several areas of the wall mount. See the DIMENSIONS drawings for various placement options.

8. Tighten the Phillips pan machine screws to complete installation of the FCA112 bracket. (See Figure 4)

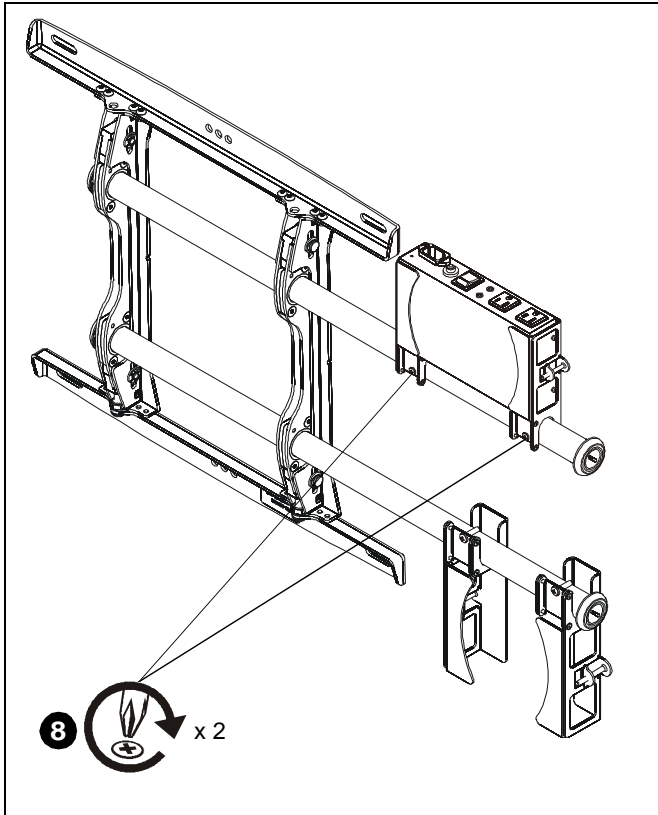

Figure 4





Our Mounts. **Your Vision.**

Chief, a products division of  
Milestone AV Technologies

8800-002722 Rev00  
©2015 Milestone AV Technologies  
[www.chiefmfg.com](http://www.chiefmfg.com)  
04/15

<b>USA/International</b>	<b>A</b> 6436 City West Parkway, Eden Prairie, MN 55344 <b>P</b> 800.582.6480 / 952.225.6000 <b>F</b> 877.894.6918 / 952.894.6918
<b>Europe</b>	<b>A</b> Franklinstraat 14, 6003 DK Weert, Netherlands <b>P</b> +31 (0) 495 580 852 <b>F</b> +31 (0) 495 580 845
<b>Asia Pacific</b>	<b>A</b> Office No. 918 on 9/F, Shatin Galleria 18-24 Shan Mei Street Fotan, Shatin, Hong Kong <b>P</b> 852 2145 4099 <b>F</b> 852 2145 4477

