

OMEGA™

4K / UHD Two-Input Switcher for HDMI and USB-C with USB Hub

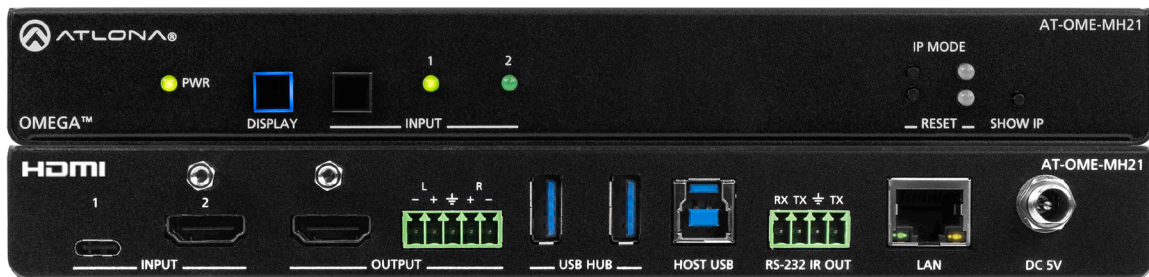

Version Information

Version	Release Date	Notes
1	May 2020	Initial release

Welcome to Atlona!

Thank you for purchasing this Atlona product. We hope you enjoy it and will take a extra few moments to register your new purchase.

Registration only takes a few minutes and protects this product against theft or loss. In addition, you will receive notifications of product updates and firmware. Atlona product registration is voluntary and failure to register will not affect the product warranty.

To register your product, go to <http://atlona.com/registration>

Sales, Marketing, and Customer Support

Main Office

Atlona Incorporated
70 Daggett Drive
San Jose, CA 95134
United States

Office: +1.877.536.3976 (US Toll-free)
Office: +1.408.962.0515 (US/International)

Sales and Customer Service Hours
Monday - Friday: 6:00 a.m. - 4:30 p.m. (PST)

<http://atlona.com/>

International Headquarters

Atlona International AG
Ringstrasse 15a
8600 Dübendorf
Switzerland

Office: +41.43.508.4321

Sales and Customer Service Hours
Monday - Friday: 09:00 - 17:00 (UTC +1)

Operating Notes



IMPORTANT: Visit <http://atlona.com/product/AT-OME-MH21> for the latest firmware updates and User Manual.

Atlona, Inc. (“Atlona”) Limited Product Warranty

Coverage

Atlona warrants its products will substantially perform to their published specifications and will be free from defects in materials and workmanship under normal use, conditions and service.

Under its Limited Product Warranty, Atlona, at its sole discretion, will either:

- repair or facilitate the repair of defective products within a reasonable period of time, restore products to their proper operating condition and return defective products free of any charge for necessary parts, labor and shipping.

OR

- replace and return, free of charge, any defective products with direct replacement or with similar products deemed by Atlona to perform substantially the same function as the original products.

OR

- refund the pro-rated value based on the remaining term of the warranty period, not to exceed MSRP, in cases where products are beyond repair and/or no direct or substantially similar replacement products exist.

Repair, replacement or refund of Atlona products is the purchaser’s exclusive remedy and Atlona liability does not extend to any other damages, incidental, consequential or otherwise.

This Limited Product Warranty extends to the original end-user purchaser of Atlona products and is non-transferrable to any subsequent purchaser(s) or owner(s) of these products.

Coverage Periods

Atlona Limited Product Warranty Period begins on the date of purchase by the end-purchaser. The date contained on the end-purchaser’s sales or delivery receipt is the proof purchase date.

Limited Product Warranty Terms – New Products

- 10 years from proof of purchase date for hardware/electronics products purchased on or after June 1, 2013.
- 3 years from proof of purchase date for hardware/electronics products purchased before June 1, 2013.
- Lifetime Limited Product Warranty for all cable products.

Limited Product Warranty Terms – Refurbished (B-Stock) Products and Discontinued Products

- 3 years from proof of purchase date for all Refurbished (B-Stock) and Discontinued hardware and electronic products purchased on or after June 1, 2013.

Remedy

Atlona recommends that end-purchasers contact their authorized Atlona dealer or reseller from whom they purchased their products. Atlona can also be contacted directly. Visit atlona.com for Atlona’s contact information and hours of operation. Atlona requires that a dated sales or delivery receipt from an authorized dealer, reseller or end-purchaser is provided before Atlona extends its warranty services. Additionally, a return merchandise authorization (RMA) and/or case number, is required to be obtained from Atlona in advance of returns.

Atlona requires that products returned are properly packed, preferably in the original carton, for shipping. Cartons not bearing a return authorization or case number will be refused. Atlona, at its sole discretion, reserves the right to reject any products received without advanced authorization. Authorizations can be requested by calling 1-877-536-3976 (US toll free) or 1-408- 962-0515 (US/international) or via Atlona’s website at atlona.com.

Exclusions

This Limited Product Warranty excludes:

- Damage, deterioration or malfunction caused by any alteration, modification, improper use, neglect, improper packaging or shipping (such claims must be presented to the carrier), lightning, power surges, or other acts of nature.

Atlona, Inc. (“Atlona”) Limited Product Warranty

- Damage, deterioration or malfunction resulting from the installation or removal of this product from any installation, any unauthorized tampering with this product, any repairs attempted by anyone unauthorized by Atlona to make such repairs, or any other cause which does not relate directly to a defect in materials and/or workmanship of this product.
- Equipment enclosures, cables, power supplies, batteries, LCD displays, and any accessories used in conjunction with the product(s).
- Products purchased from unauthorized distributors, dealers, resellers, auction websites and similar unauthorized channels of distribution.

Disclaimers

This Limited Product Warranty does not imply that the electronic components contained within Atlona’s products will not become obsolete nor does it imply Atlona products or their electronic components will remain compatible with any other current product, technology or any future products or technologies in which Atlona’s products may be used in conjunction with. Atlona, at its sole discretion, reserves the right not to extend its warranty offering in instances arising outside its normal course of business including, but not limited to, damage inflicted to its products from acts of god.

Limitation on Liability

The maximum liability of Atlona under this limited product warranty shall not exceed the original Atlona MSRP for its products. To the maximum extent permitted by law, Atlona is not responsible for the direct, special, incidental or consequential damages resulting from any breach of warranty or condition, or under any other legal theory. Some countries, districts or states do not allow the exclusion or limitation of relief, special, incidental, consequential or indirect damages, or the limitation of liability to specified amounts, so the above limitations or exclusions may not apply to you.

Exclusive Remedy

To the maximum extent permitted by law, this limited product warranty and the remedies set forth above are exclusive and in lieu of all other warranties, remedies and conditions, whether oral or written, express or implied. To the maximum extent permitted by law, Atlona specifically disclaims all implied warranties, including, without limitation, warranties of merchantability and fitness for a particular purpose. If Atlona cannot lawfully disclaim or exclude implied warranties under applicable law, then all implied warranties covering its products including warranties of merchantability and fitness for a particular purpose, shall provide to its products under applicable law. If any product to which this limited warranty applies is a “Consumer Product” under the Magnuson-Moss Warranty Act (15 U.S.C.A. §2301, ET SEQ.) or other applicable law, the foregoing disclaimer of implied warranties shall not apply, and all implied warranties on its products, including warranties of merchantability and fitness for the particular purpose, shall apply as provided under applicable law.

Other Conditions

Atlona’s Limited Product Warranty offering gives legal rights, and other rights may apply and vary from country to country or state to state. This limited warranty is void if (i) the label bearing the serial number of products have been removed or defaced, (ii) products are not purchased from an authorized Atlona dealer or reseller. A comprehensive list of Atlona’s authorized distributors, dealers and resellers can be found at atlona.com.

Safety and Certification

CAUTION
 RISK OF ELECTRIC SHOCK
 DO NOT OPEN

CAUTION: TO REDUCE THE RISK OF
 ELECTRIC SHOCK
 DO NOT OPEN ENCLOSURE OR EXPOSE
 TO RAIN OR MOISTURE.
 NO USER-SERVICEABLE PARTS
 INSIDE REFER SERVICING TO
 QUALIFIED SERVICE PERSONNEL.



The exclamation point within an equilateral triangle is intended to alert the user to the presence of important operating and maintenance instructions in the literature accompanying the product.



The information bubble is intended to alert the user to helpful or optional operational instructions in the literature accompanying the product.

1. Read these instructions.
2. Keep these instructions.
3. Heed all warnings.
4. Follow all instructions.
5. Do not use this product near water.
6. Clean only with a dry cloth.
7. Do not block any ventilation openings. Install in accordance with the manufacturer's instructions.
8. Do not install or place this product near any heat sources such as radiators, heat registers, stoves, or other apparatus (including amplifiers) that produce heat.
9. Do not defeat the safety purpose of a polarized or grounding-type plug. A polarized plug has two blades with one wider than the other. A grounding type plug has two blades and a third grounding prong. The wide blade or the third prong are provided for your safety. If the provided plug does not fit into your outlet, consult an electrician for replacement of the obsolete outlet.
10. Protect the power cord from being walked on or pinched particularly at plugs, convenience receptacles, and the point where they exit from the product.
11. Only use attachments/accessories specified by Atlona.
12. To reduce the risk of electric shock and/or damage to this product, never handle or touch this unit or power cord if your hands are wet or damp. Do not expose this product to rain or moisture.
13. Unplug this product during lightning storms or when unused for long periods of time.
14. Refer all servicing to qualified service personnel. Servicing is required when the product has been damaged in any way, such as power-supply cord or plug is damaged, liquid has been spilled or objects have fallen into the product, the product has been exposed to rain or moisture, does not operate normally, or has been dropped.



FCC Statement

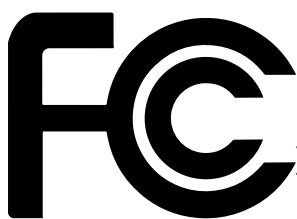

FCC Compliance and Advisory Statement: This hardware device complies with Part 15 of the FCC rules. Operation is subject to the following two conditions: 1) this device may not cause harmful interference, and 2) this device must accept any interference received including interference that may cause undesired operation. This equipment has been tested and found to comply with the limits for a Class A digital device, pursuant to Part 15 of the FCC Rules.

These limits are designed to provide reasonable protection against harmful interference in a commercial installation. This equipment generates, uses, and can radiate radio frequency energy and, if not installed or used in accordance with the instructions, may cause harmful interference to radio communications. However there is no guarantee that interference will not occur in a particular installation. If this equipment does cause harmful interference to radio or television reception, which can be determined by turning the equipment off and on, the user is encouraged to try to correct the interference by one or more of the following measures: 1) reorient or relocate the receiving antenna; 2) increase the separation between the equipment and the receiver; 3) connect the equipment to an outlet on a circuit different from that to which the receiver is connected; 4) consult the dealer or an experienced radio/TV technician for help. Any changes or modifications not expressly approved by the party responsible for compliance could void the user's authority to operate the equipment. Where shielded interface cables have been provided with the product or specified additional components or accessories elsewhere defined to be used with the installation of the product, they must be used in order to ensure compliance with FCC regulations.



The terms HDMI, HDMI High-Definition Multimedia Interface, and the HDMI Logo are trademarks or registered trademarks of HDMI licensing Administrator, Inc.

Table of Contents

Introduction	9
Features	9
Package Contents	9
Panel Description	10
Front Panel	10
Rear Panel	11
Installation	12
Audio	12
RS-232 / IR	13
Connection Instructions	14
Connection Diagram	15
IP Configuration	16
Switching the IP Mode	16
Displaying the IP Address	16
Setting the IP Address using the Web Server	17
Auto IP Mode	18
Resetting to Factory-Default Settings	18
Device Operation	19
LED Indicators	19
Web Server	20
Registration	20
Logging In	21
Selecting the Input	22
Auto Switching	23
Enabling / Disabling Auto Switching	23
Scaler Pass-Through	24
Notes on Scaling	25
Audio Management	26
Audio Output Muting	26
De-embedding External Analog Audio	26
HDCP Content	27
EDID Management	28
Using the Downstream EDID	28
EDID Presets	29
Storing EDID Data	30
User Management	33
Changing the Administrator Password	33
Creating and Deleting User Accounts	34
System Configuration	35
Getting the MAC Address	35
Changing the Telnet Port	36
Telnet Login Mode	36
Adjusting Telnet Timeout	37
Setting the Host Name	38
Locking / Unlocking the Front Panel	39
Resetting to Factory-Default Settings	40
Downloading System Configuration	41
Restoring System Configuration	42
USB Modes	44
USB-C Super Speed Mode	44
Follow USB Mode	45
Manual Mode	46

Configuration and Management Interfaces	47
Info Page	47
I/O Settings Page	48
Display Page	50
RS-232 Page	54
EDID Page	55
Config Page	56
System Page	57
Appendix	59
Updating the Firmware	59
Mounting Instructions	61
Specifications	63

Introduction

The Atlona **AT-OME-MH21** is a compact, versatile switcher with HDMI and USB-C inputs. It is equipped with features for complete AV integration in huddle rooms and small meeting spaces, including automatic switching and display control, audio de-embedding, and a USB 3.0 hub for video conferencing peripherals or touch displays. Part of the Omega™ Series of integration products for modern AV communications and collaboration, the OME-MH21 is HDCP 2.2 compliant and supports 4K HDR and 4K/60 4:4:4 at HDMI data rates up to 18 Gbps. Additionally, 4K downscaling to 1080p @ 60, 30, or 24 Hz is available when connected to an HD display. The OME-MH21 includes USB 3.0 and USB-C interfaces for two host PCs, plus two peripheral devices such as a camera, microphone, speakerphone, touch-enabled display, or keyboard and mouse.

Features

- Two-input AV switcher
- USB-C input for AV and data
- Integrated USB 3.0 hub
- Selectable 4K to 1080p downscaling
- Audio de-embedding
- Automatic display control
- Automatic input selection using hot plug detect and video detection technology

Package Contents

1 x AT-OME-MH21
1 x USB-C cable
1 x IR emitter
1 x 5-pin captive screw connector
1 x 4-pin captive screw connector
2 x Mounting brackets
4 x Mounting screws
4 x Rubber feet
1 x 5 V DC power supply
1 x IEC power cord
1 x Installation Guide

Panel Description

Front Panel

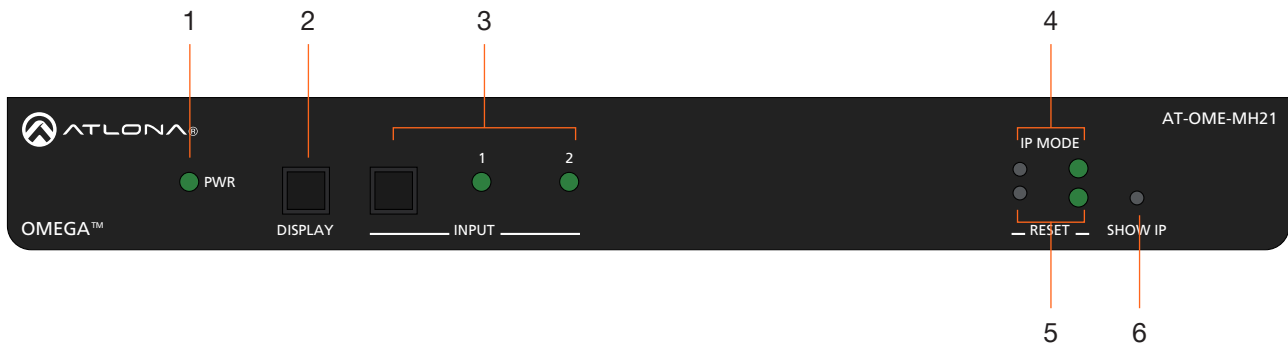

- 1 PWR**
 This LED indicator glows solid green when the unit is powered.
- 2 DISPLAY**
 Press and release this button to toggle power on the connected display.
- 3 INPUT**
 Press and release this button to toggle between the HDMI and USB-C input. A solid green LED indicator will display the currently active input. Each LED indicator corresponds to the input on the rear panel of the unit.
- 4 IP MODE**
 Press and release this button, next to the green LED indicator, to switch the IP mode between DHCP and static IP modes. The LED indicator will provide the current IP mode. Refer to [IP Configuration \(page 16\)](#) for more information.
- 5 RESET**
 Press and release this button to reset the unit to factory-default settings. Refer to [Resetting to Factory-Default Settings \(page 18\)](#) for more information.
- 6 SHOW IP**
 Press and release this button to display the IP address of the AT-OME-MH21 on the connected display.

Rear Panel

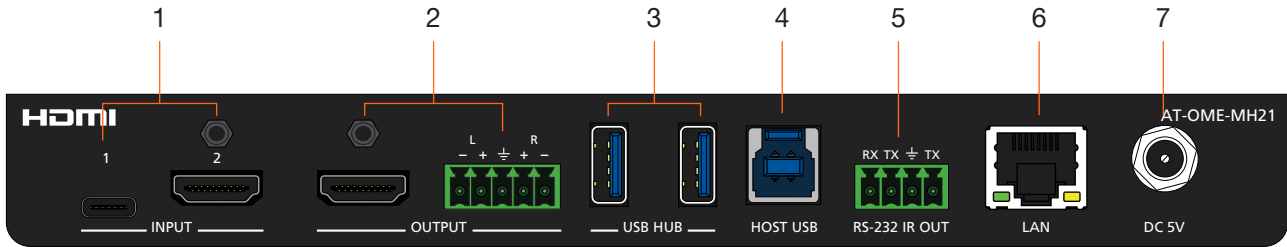

1 INPUT

Connect a USB-C source to the USB-C port. Connect an HDMI cable from the HDMI port to a UHD/HD source.

2 OUTPUT

Connect an HDMI cable from the HDMI output to a display or other sink device. Connect an audio output device to this port using the included 5-pin captive screw block. Refer to [Audio \(page 12\)](#) for wiring information.

3 USB HUB

Connect a USB device to each of these ports.

4 HOST USB

Connect to a computer using a USB-B to USB-A cable.

5 RS-232 / IR OUT

Connect the included 4-pin captive screw block to this receptacle. The RS-232 port provides RS-232 control for the AT-OME-MH21 and the connected display. Refer to [RS-232 / IR \(page 13\)](#) for more information.

6 LAN

Connect an Ethernet cable to this port to control the unit and/or to pass Ethernet to a local device.

7 DC 5V

Connect the included locking 5 V DC power supply to this power receptacle.

Installation

Audio

The AT-OME-MH21 provides two-channel LPCM audio de-embedding of the source device, using a dedicated audio output port. Use the included 5-pin captive-screw terminal block. Balanced audio connections use two signal wires and a ground to minimize interference in audio signals. Unbalanced output audio is not recommended and may require additional equipment.

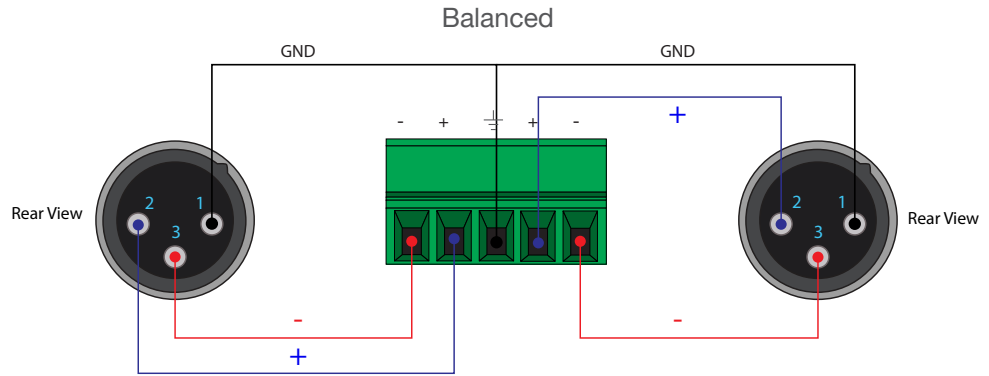
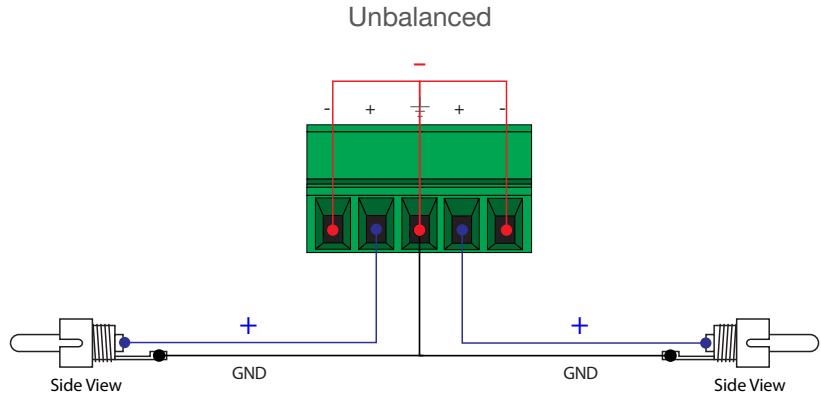
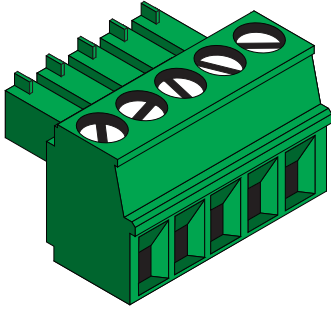

RS-232 / IR

The AT-OME-MH21 provides control using RS-232 and/or IR. This step is optional.

1. Use wire strippers to remove a portion of the cable jacket.
2. Remove at least 3/16" (5 mm) from the insulation of the RX, TX, and GND wires for the RS-232 connection.
3. Insert the TX, RX, and GND wires into correct terminal using one of the included 4-pin captive screw connectors.
4. Repeat step 2 for the S and GND wires for the IR connection.
5. Insert the S (signal) wire in to the TX terminal and the ground wire to the GND terminal.
6. Tighten the captive screws to secure the wires in place. Do not over-tighten or use high-torque devices to prevent damage to the connector block.



NOTE: Typical DB9 connectors use pin 2 for TX, pin 3 for RX, and pin 5 for ground. On some devices functions of pins 2 and 3 are reversed. Note that the signal (S) pin for the IR is labeled as "TX" on the port.

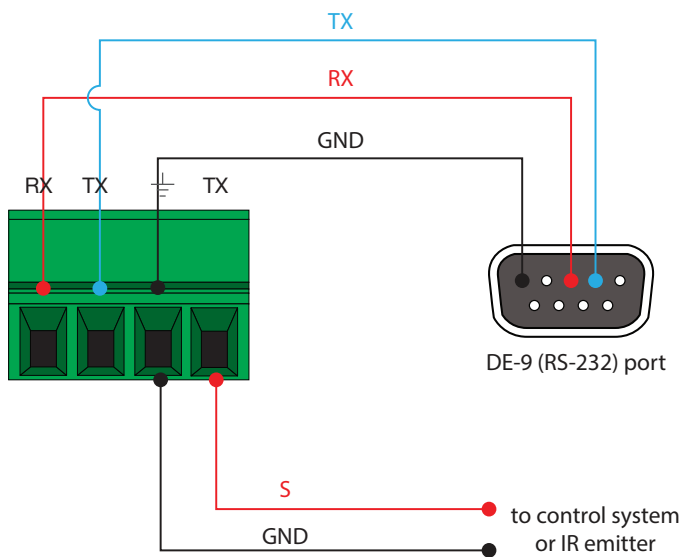
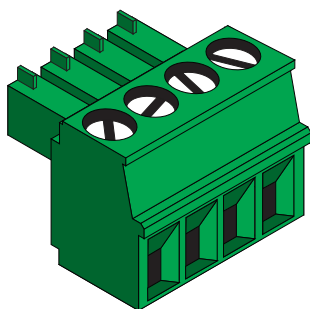

NOTE: If connecting an IR emitter, the wire that has the white line marking is the signal line (S). The black wire is ground (GND).

Connection Instructions

1. Connect a USB-C device to the **INPUT 1** port.
2. Connect an HDMI cable from the **INPUT 2** port to a UHD/HD source device.
3. Connect an HDMI cable from the HDMI **OUTPUT** port to a display device.
4. OPTIONAL: Connect an audio output device to this port using the included captive screw block. Refer to [Audio \(page 12\)](#) for wiring information.
5. Connect up to two USB devices to the **USB HUB** ports.
6. Connect a computer to the **HOST USB** port, using a USB-A to USB-B cable.
7. OPTIONAL: Connect a serial cable from **RS-232** port to a display device. Refer to [RS-232 / IR \(page 13\)](#) for wiring information. Connect an IR emitter to the **IR OUT** port.
8. Connect an Ethernet cable to the **LAN** port to control the AT-OME-MH21.
9. Connect the included 5 V DC power supply from this receptacle to an available AC outlet.

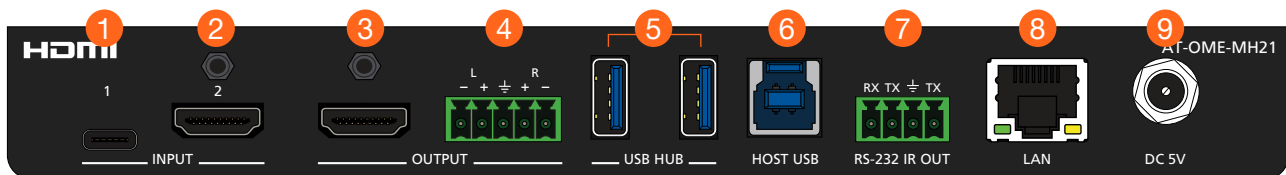

Connection Diagram

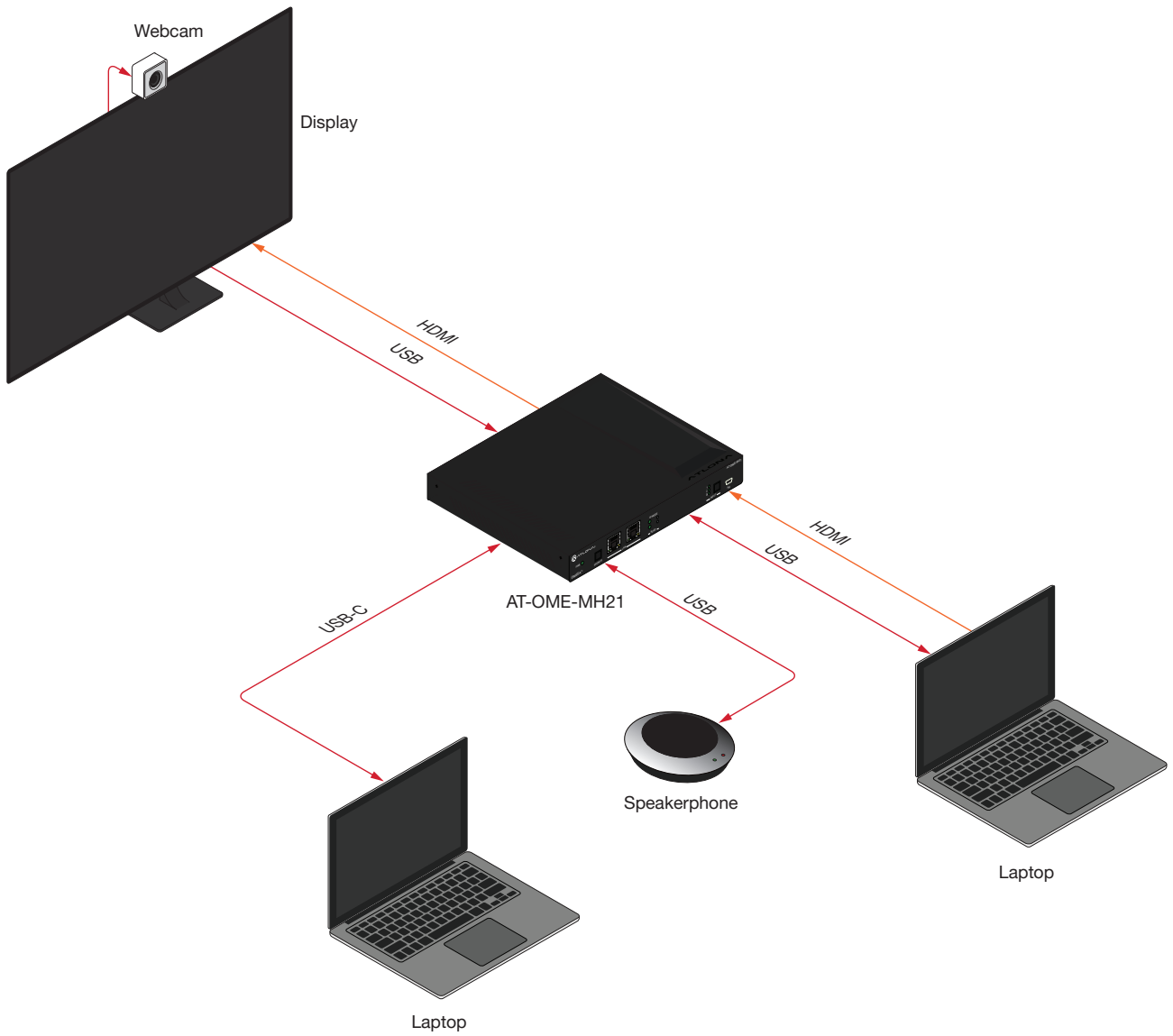

IP Configuration

The AT-OME-MH21 is shipped with DHCP enabled. Once connected to a network, the DHCP server (if available), will automatically assign an IP address to the unit. Use an IP scanner, along with the MAC address on the bottom of the unit, to identify both the unit and its IP address on the network.

If the AT-OME-MH21 is unable to detect a DHCP server within 15 seconds, then the unit will use a self-assigned IP address within the range of 169.254.xxx.xxx. If this occurs, refer to [Auto IP Mode \(page 18\)](#) for more information.

If a static IP address is desired, the unit can be switched to static IP mode. Use one of the following procedures to switch between DHCP and static IP mode. The default static IP address of the AT-OME-MH21 is 192.168.1.254.

Switching the IP Mode

1. Make sure the AT-OME-MH21 is powered and ready for operation.
2. Press and hold the **IP MODE** button.

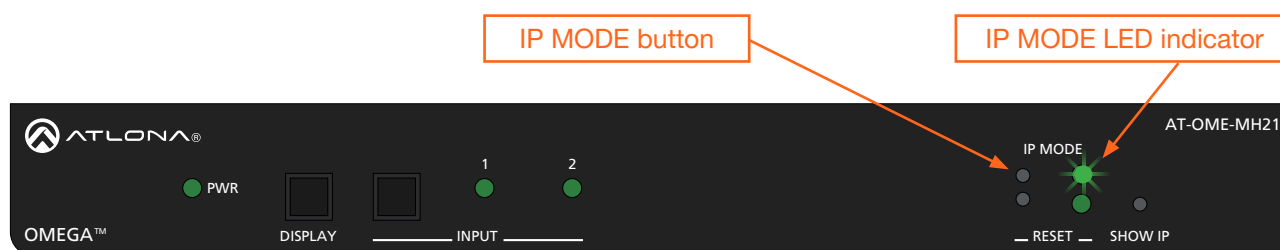

3. Release the button once the **IP MODE** LED indicator begins to flash green. The number of flashes will indicate the currently selected IP mode.

Input LED Indicators flash	Description
Two	DHCP mode
Three	Factory Static IP mode (IP address set to 192.168.1.254)

Displaying the IP Address

1. Make sure the unit is powered.
2. Connect a display to the HDMI output and power the display.
3. Press and release the **SHOW IP** button on the front panel. The IP address will be displayed in the upper-left corner of the display.

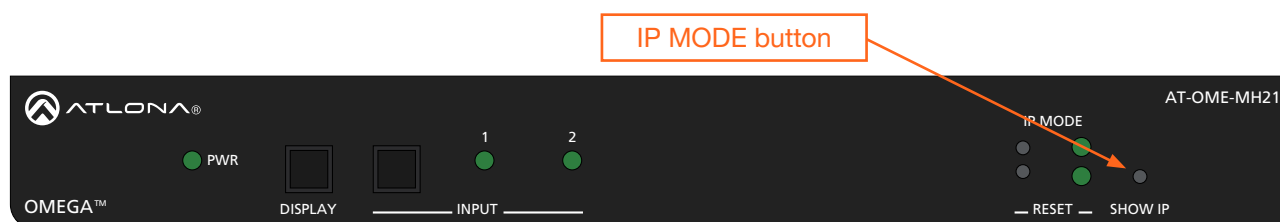

Setting the IP Address using the Web Server

The IP mode of the AT-OME-MH21 can also be set using the built-in web server. In order to access the web server, the IP address of the AT-OME-MH21 must be known. Refer to [Web Server \(page 20\)](#) for more information.

1. Open the desired web browser and enter the IP address of the AT-OME-MH21.
2. Login using the required credentials.
3. Click **System** in the menu bar.
4. Under the **Network** window group, click the **IP Mode** toggle switch to select either **DHCP**, or **STATIC IP**. The default setting is **DHCP**. If set to **STATIC IP**, the **IP**, **Netmask**, and **Gateway** fields can be modified.

By default, **STATIC IP** mode sets the IP settings to the following values:

IP Address: 192.168.1.254
 Network Mask: 255.255.0.0
 Gateway: 192.168.1.1

5. Click the **Save** button to commit changes.

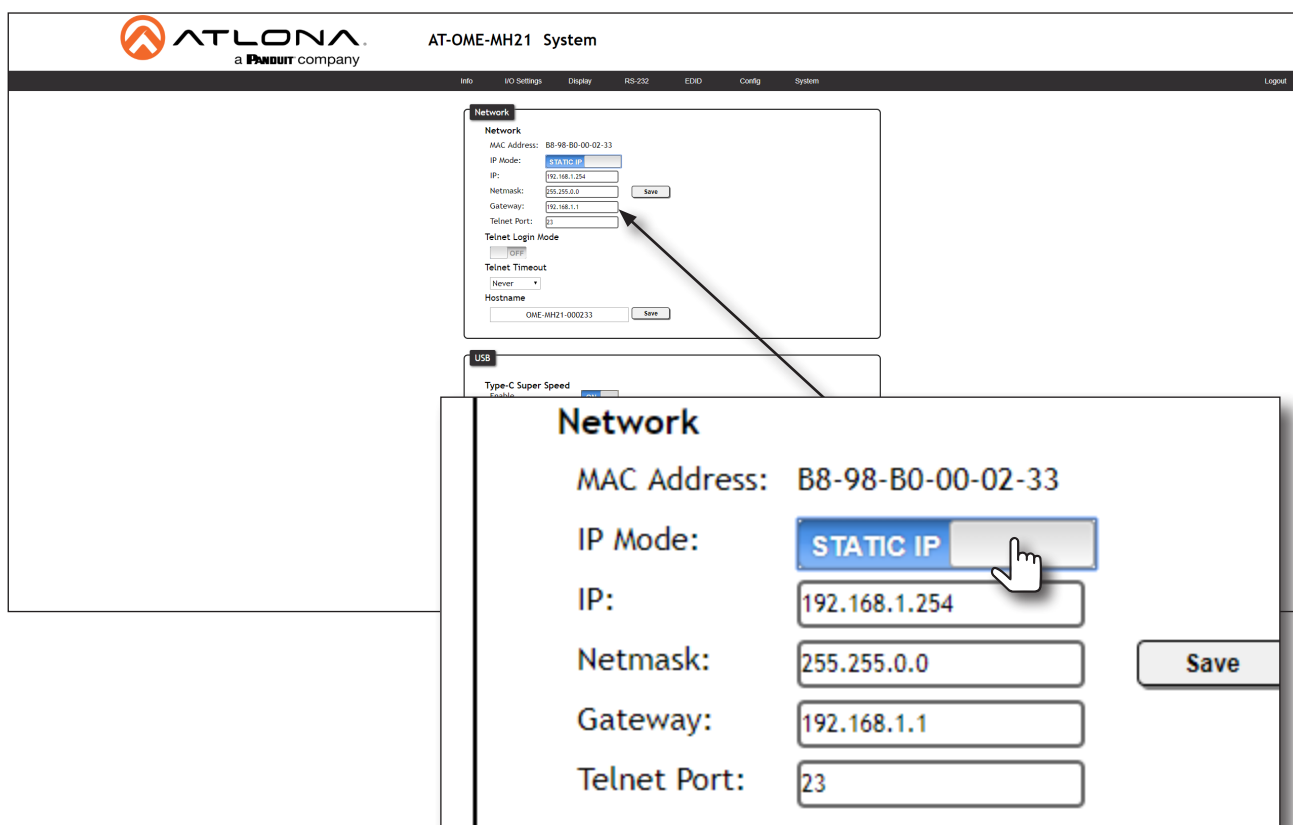

Auto IP Mode

If the AT-OME-MH21 is unable to detect a DHCP server within 15 seconds, then the unit will use a self-assigned IP address within the range of 169.254.xxx.xxx. If this occurs, connect an Ethernet cable directly from the **LAN** port of the AT-OME-MH21 to the LAN port of a computer, then do the following under Microsoft Windows.

1. Click **Start > Settings > Control Panel > Network and Sharing Center**.
2. Click **Change adapter settings**.
3. Right-click on the adapter that is used to establish a wired connection to the network, and select **Properties** from the context menu.
4. Under the **Ethernet Properties** dialog box, select **Internet Protocol Version 4** and then click the **Properties** button.
5. Click the **Use the following IP address** radio button.



IMPORTANT: Before continuing, write down the current IP settings in order to restore them, later. If **Obtain an IP address automatically** and **Obtain DNS server automatically** are selected, then this step is not required.

6. Enter the desired static IP address or the IP address provided by the network administrator. If the computer does not require Internet access or if a statically-assigned IP address is being used, then an IP address of 169.254.xxx.xxx can be entered.
7. Set the subnet mask to 255.255.0.0.
8. Click the **OK** button then close all **Control Panel** windows.

Resetting to Factory-Default Settings



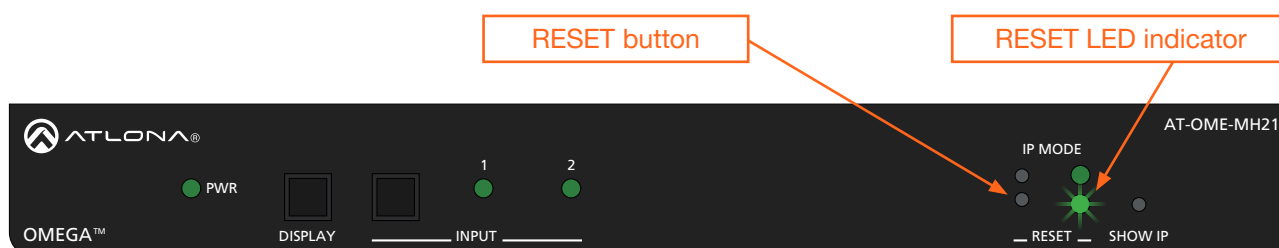





1. Press and hold the **RESET** button for five seconds.
2. Release the **RESET** button once the **RESET** LED indicator begins to flash. The LED indicator will flash three times to indicate that the unit has been reset to factory-default settings.



Device Operation

LED Indicators

The LED indicators on both the front and rear of the unit provide basic information on the current status of the AT-OME-MH21.

LED		Description
PWR	Solid green 	<ul style="list-style-type: none"> Unit is powered using the included 24 V DC power supply.
	Off 	<ul style="list-style-type: none"> Unit is not powered.
INPUT	Solid 	<ul style="list-style-type: none"> The input is the currently selected (active) input.
	Off 	<ul style="list-style-type: none"> The input is not active.
IP MODE	Flash green (2x) 	<ul style="list-style-type: none"> Flashes twice to indicate that the unit is being set to DHCP mode. Refer to IP Configuration (page 19) for more information.
	Flash green (3x) 	<ul style="list-style-type: none"> Flashes three times to indicate that the unit is being set to static IP mode and will be assigned the IP address of 192.168.1.254.
	Off	<ul style="list-style-type: none"> Normal operating mode.
RESET	Flash green (3x) 	<ul style="list-style-type: none"> Unit is being set to factory-default settings. Refer to Resetting to Factory-Default Settings (page 18) for more information.
	Off 	<ul style="list-style-type: none"> Normal operating mode.

Web Server

Most of the AT-OME-MH21 operation is handled through the built-in web server. In order to access the web server, the IP address of the unit must be known. Refer to [IP Configuration \(page 16\)](#) for more information. Before using the web server, it must be registered with a username and password.

Registration

1. Launch a desired web browser and enter the IP address of the AT-OME-MH21 in the address bar.
2. Enter the desired username in the **Username** field. In the example below, the username `admin` is used.
3. Enter the desired password in the **Password** field.



IMPORTANT: The password must contain a minimum of 8 characters, including: 1 uppercase character, 1 lowercase character, and 1 number.

4. Verify the password by entering it in the **Confirm** field.
5. Click the **Submit** button.

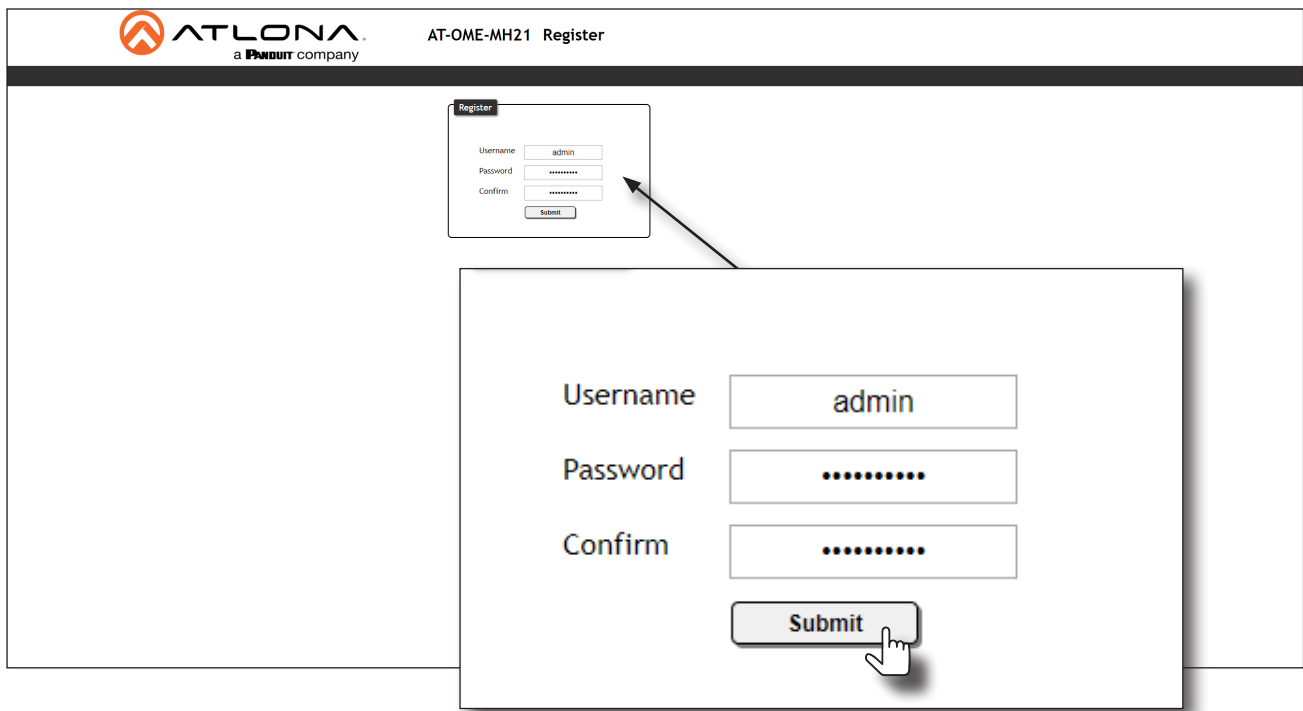

The screenshot displays the AT-OME-MH21 Register web interface. At the top, the ATLONA logo and 'a PANOUT company' are visible on the left, and 'AT-OME-MH21 Register' is on the right. The main content area features a registration form with the following elements:

- Username:** A text input field containing the text 'admin'.
- Password:** A text input field filled with dots, representing a masked password.
- Confirm:** A text input field filled with dots, representing a masked confirmation password.
- Submit:** A button labeled 'Submit' with a mouse cursor hovering over it.

A smaller inset window, titled 'Register', shows a simplified version of the form with an arrow pointing to the 'Submit' button, indicating the final step of the registration process.

6. The **Login** page will be displayed.
7. Registration is complete.

Logging In

Before logging in to the web server, make sure the registration process has been completed. Refer to [Registration \(page 20\)](#) for more information.

1. Launch the desired web browser and enter the IP address of the AT-OME-MH21 in the address bar.
2. Enter the correct username and password in the respective fields.
3. Click the **Submit** button.



NOTE: If using a secure connection, click the **Toggle HTTP/HTTPS** button.

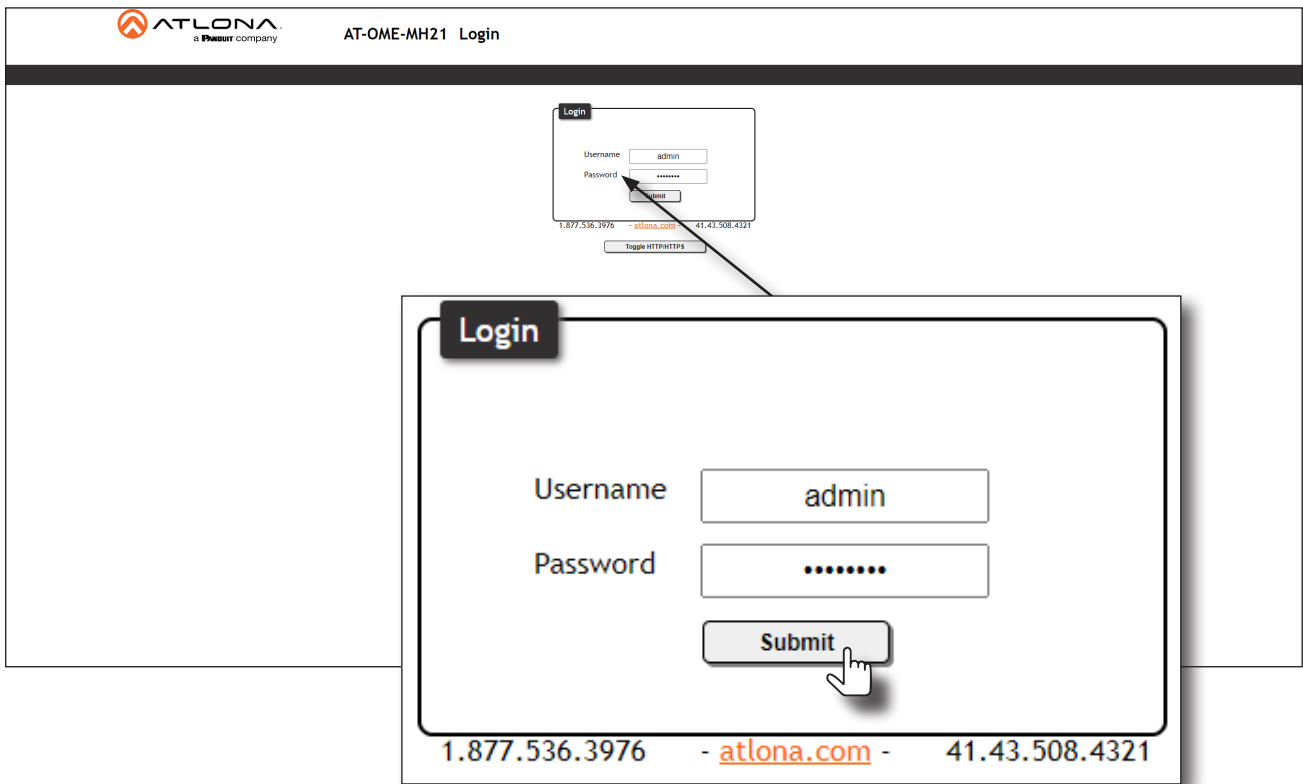

4. The **Info** page will be displayed and the login process is complete.

Selecting the Input

1. Login to the web server. Refer to [Web Server \(page 20\)](#) for more information.
2. Click **I/O Settings** in the menu.
3. Under the **Output** window group, click the **Input Selection** drop-down list to select the desired input.

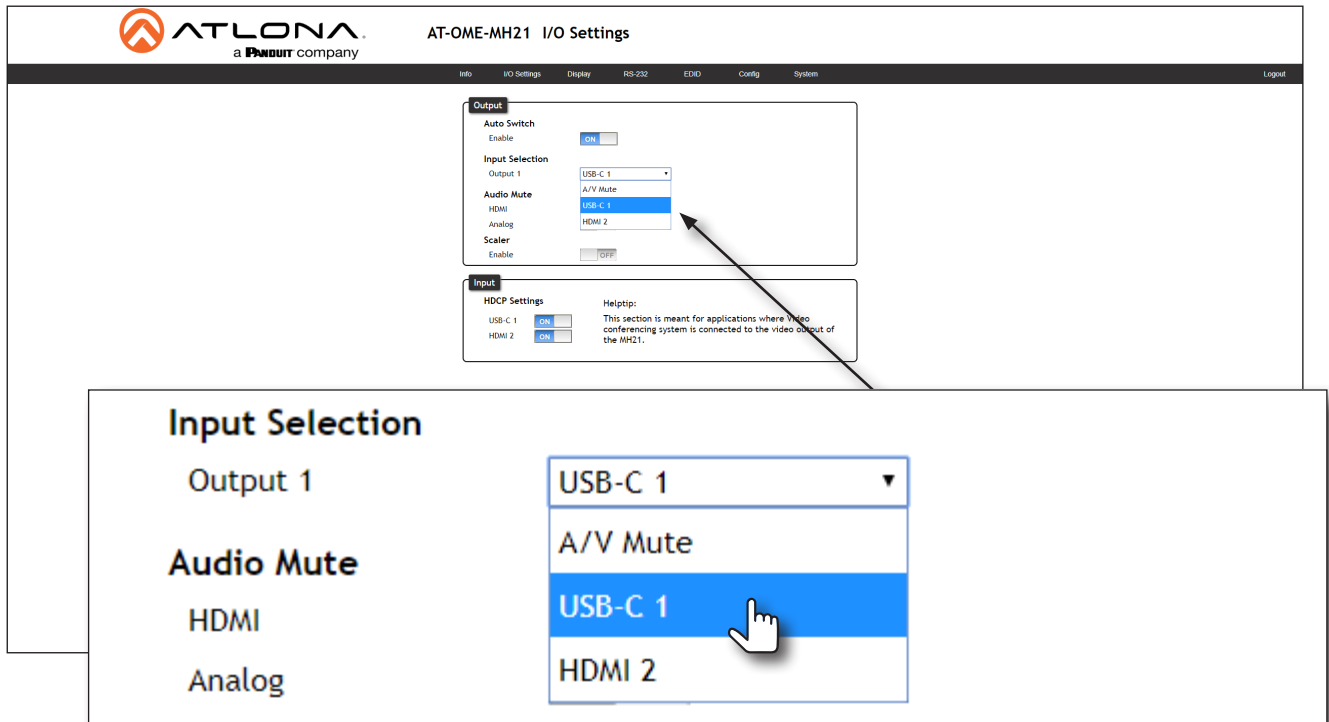

Selecting **A/V Mute** will disable the audio and video output on both the HDMI and analog output ports.

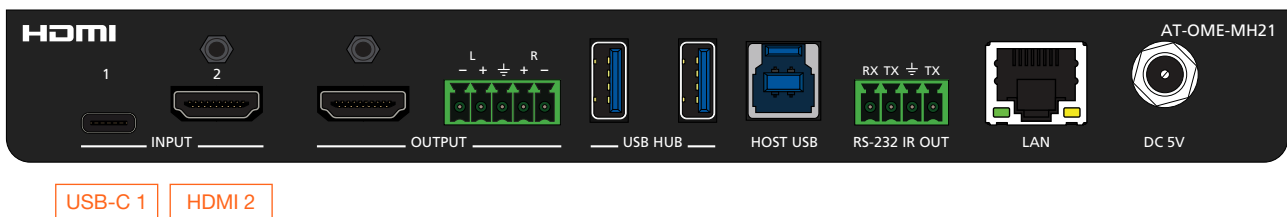

Auto Switching

The AT-OME-MH21 provides auto switching capability, which is enabled by default. This feature will automatically switch the input to the most recently-connected source. If a source is disconnected, then the input will automatically be switched to the previously-connected source.

Enabling / Disabling Auto Switching

By default, auto-switching is enabled on the AT-OME-MH21, allowing the unit to automatically switch between inputs when sources are connected or disconnected.

1. Login to the web server. Refer to [Web Server \(page 20\)](#) for more information.
2. Click **I/O Settings** in the menu bar.
3. Click the **Auto Switch mode** toggle switch to the **ON** position to enable auto-switching. This is the default setting. If auto switching is not desired, click this toggle switch to the **OFF** position.



NOTE: The AT-OME-MH21 retains the currently selected input, even after the unit is powered-off then powered-on. The system will re-evaluate the auto switching logic after power on and select an input.

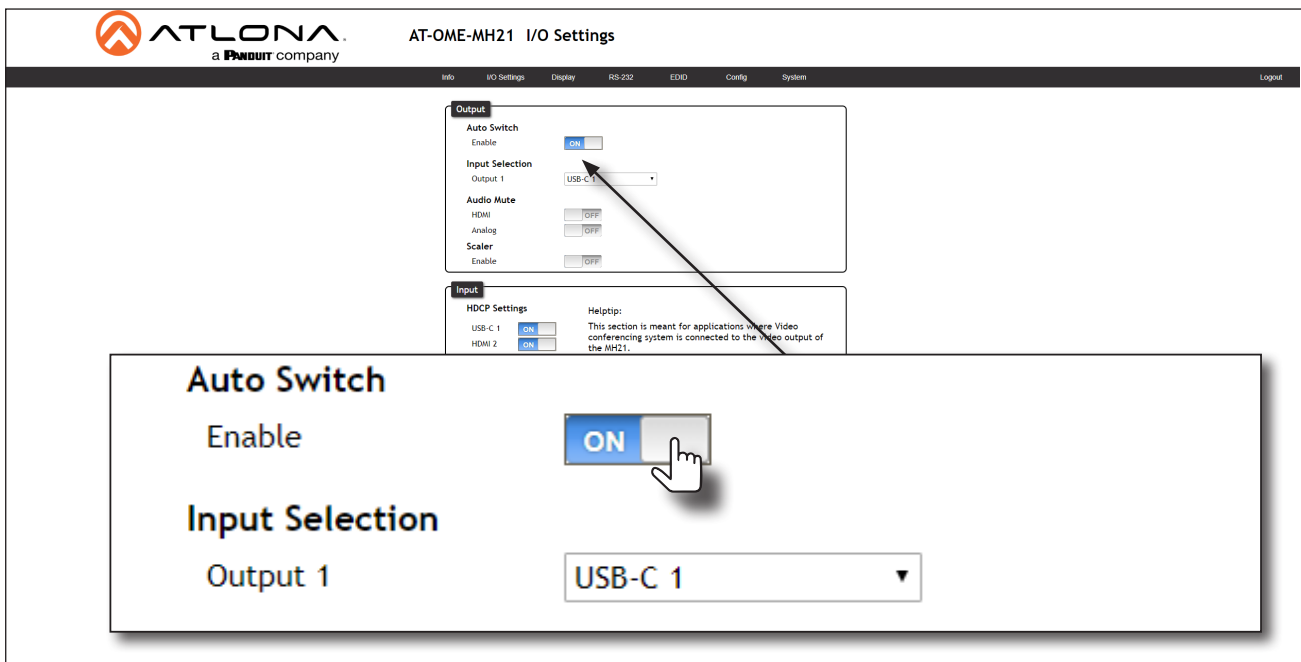

The screenshot displays the AT-OME-MH21 I/O Settings page. The 'Output' section includes a toggle for 'Auto Switch' (set to ON), a dropdown for 'Input Selection' (set to USB-C 1), and 'Audio Mute' options for HDMI, Analog, and Scaler (all set to OFF). The 'Input' section shows 'HDCP Settings' for USB-C 1 and HDMI 2 (both ON). A callout box highlights the 'Auto Switch' and 'Input Selection' settings, showing the 'ON' toggle and the 'USB-C 1' dropdown menu.

4. Auto switching configuration is complete.

Scaler Pass-Through

Click this toggle switch to enable or disable the scaler pass-through feature. When set to the **ON** position, 4K content will be down-scaled to 1080p. When set to the **OFF** position, the output resolution / timing will be the same as the input source. The default setting is **OFF**.



IMPORTANT: The scaler will only downscale the image resolution and does not support frame rate scaling/conversion such as 60 Hz to 30 Hz. The frame rate of the source must be supported by the display device.

1. Login to the web server. Refer to [Web Server \(page 20\)](#) for more information.
2. Click **I/O Settings** in the menu bar.
3. Click the **Scaler** toggle switch.

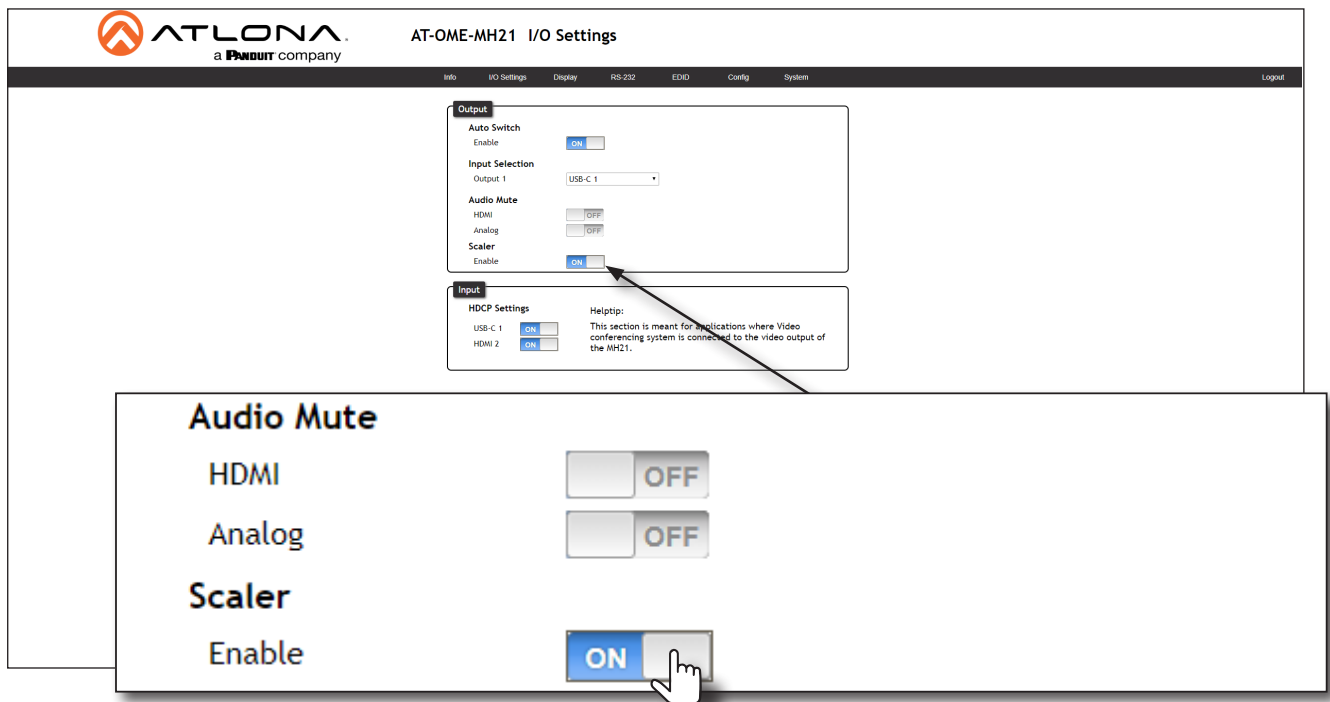

The screenshot shows the AT-OME-MH21 I/O Settings page. The 'Scaler' toggle switch is currently set to 'ON'. A callout box highlights the 'Scaler' section, showing the 'Enable' toggle switch set to 'ON'.

4. Click the toggle switch again, to return the **Scaler** toggle to the **OFF** (default) position.

Notes on Scaling

The following section provides important information about how the AT-OME-MH21 processes 4K (UHD) video signals.

- The HDMI **OUTPUT** port supports up to 4K @ 60 Hz, 12-bit, with HDR.
- If the source is 4K, and the HDMI **OUTPUT** port is connected to a 1080p (not 4K-capable) display, then the output will be down-scaled as follows:

Input	Output
4K @ 24 Hz	1080p @ 24 Hz
4K @ 30 Hz	1080p @ 30 Hz
4K @ 60 Hz, 4:2:0	1080p @ 60 Hz, YUV/RGB 4:4:4

- HDR / Dolby Vision / HLG formats cannot be down-scaled to 1080p. If the source content has HDR, then the color saturation on the video output may appear “washed out”.
- The internal scaler will be bypassed if the connected display supports the resolution and timing information from the source device.

Audio Management

The AT-OME-MH21 provides control over audio muting on both the **HDMI** and **ANALOG** outputs.

Audio Output Muting

1. Login to the web server. Refer to [Web Server \(page 20\)](#) for more information.
2. Click **I/O Settings** in the menu bar.
3. Locate the **Audio Mute** section.
4. Click the toggle switch for the desired output. For example, to mute the audio output on the **HDMI** output, set this toggle switch to the **ON** position. To re-enable the audio for the output, set the toggle switch to the **OFF** position.

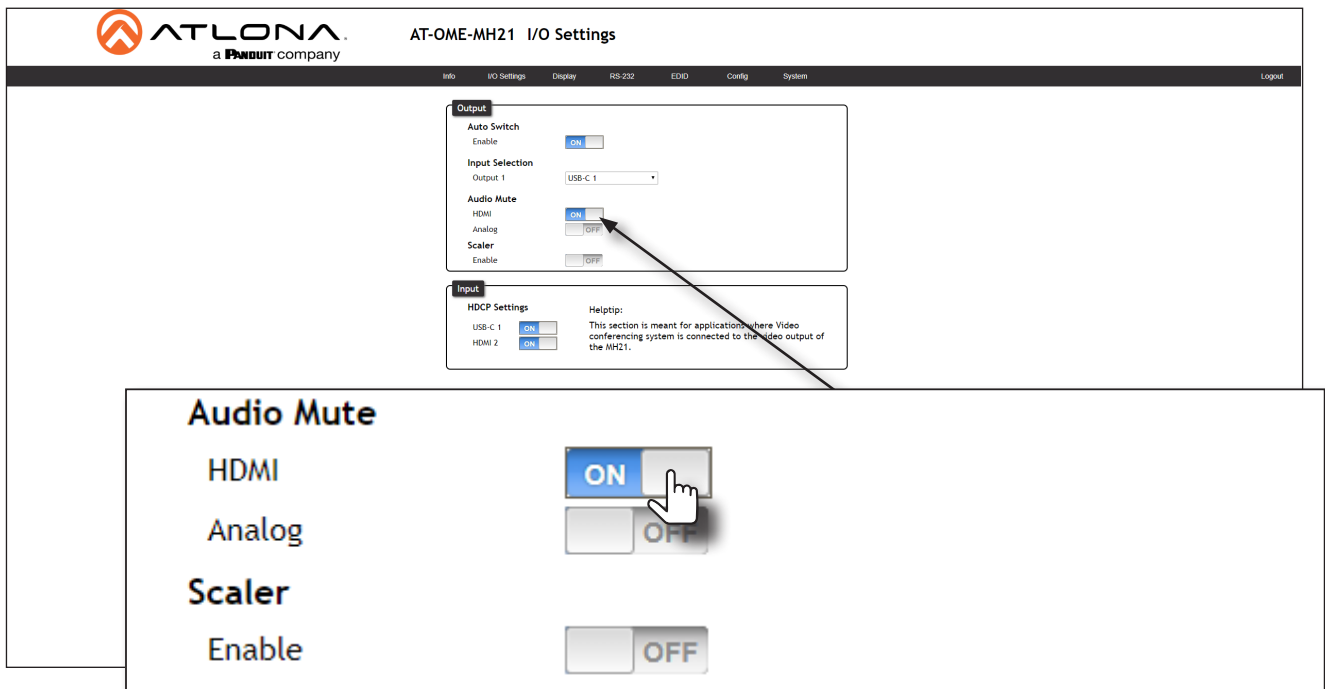

De-embedding External Analog Audio

Digital audio can be de-embedded from the **HDMI** or **USB-C** inputs and output to an external audio device over the analog **OUTPUT** port. De-embedded audio is limited to analog two-channel audio. LPCM multichannel audio is downmixed to two-channel LPCM audio. Refer to the [Audio \(page 12\)](#) for wiring information.

HDCP Content

Normally, if a source is transmitting HDCP content to a display that is not HDCP-compatible, then the resulting image on the display can be “snow”, image flickering, or no picture. For example, in the illustration below, a blu-ray player is connected to the AT-OME-MH21. A non-compliant display is connected to a receiver, which is connected to the AT-OME-MH21 using HDMI.



IMPORTANT: Not all source devices are capable of transmitting non-HDCP content. For example, Sony PlayStation® gaming consoles and Apple® computers will always default to HDCP. However, if they detect a non-hdcp source, non-hdcp content will be transmitted.

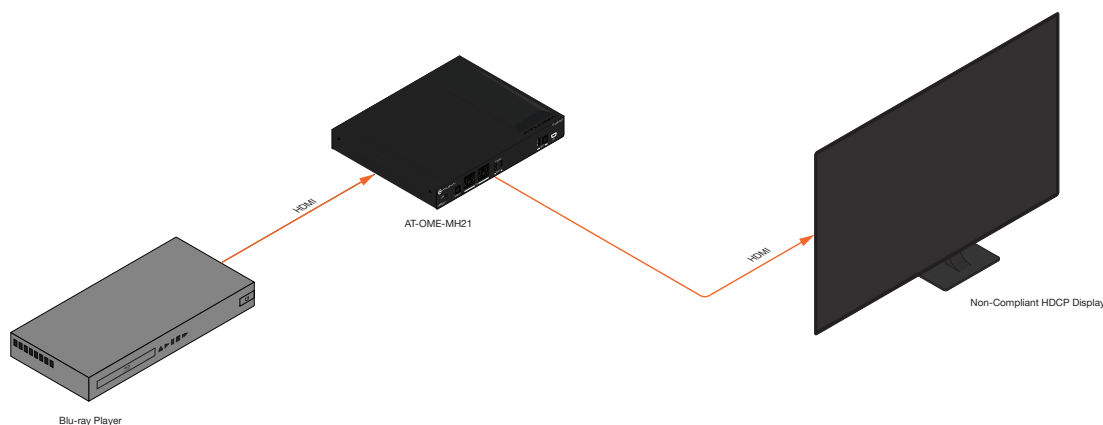

By default, the laptop may transmit HDCP content. However, when connected to a display that does not support HDCP, the laptop must be instructed to send non-HDCP content, in order for the content to be displayed.

1. Login to the web server. Refer to [Web Server \(page 20\)](#) for more information.
2. Click **I/O Settings** in the menu bar.
3. Locate the **Input** section.
4. Click the toggle switch next to the desired input. In this example, clicking the **USB-C 1** toggle switch and setting it to the **OFF** position will instruct the source connected to the USB-C port to send non-HDCP content, if possible. If the display is unable to receive HDCP content, then a green splash screen will appear on the connected display, with the following message:

HDCP INCOMPATIBILITY

Input

HDCP Settings

USB-C 1 OFF

HDMI 2 ON

Helptip:

This section is meant for applications where Video conferencing system is connected to the video output of the MH21.

EDID Management

Before a source can send picture and sound to a display device, the source reads the EDID (Extended Display Identification Data) stored in the display. The EDID contains information about what type of video and audio formats are supported by the display. The AT-OME-MH21 can use either the downstream EDID (from the display/sink) or use a built-in EDID preset. Custom EDID data can also be stored in a user-defined preset. This section will cover each of the following topics:

- EDID Presets
- Using the Downstream EDID
- Storing EDID Data

Using the Downstream EDID

By default, the AT-OME-MH21 will read the EDID from the display device. The term “downstream” is used to describe any device that receives a signal from another device. For example, if a Blu-ray player is connected to a display, the display is said to be “downstream” of the Blu-ray player.

1. Login to the web server. Refer to [Web Server \(page 20\)](#) for more information.
2. Click **EDID** in the menu bar.
3. Locate the **EDID Settings** section.
4. Click the drop-down list next to the desired input and select **Connected Displays**. For example, to have the **USB-C 1** port use the EDID of the connected display, click the **Input 1** drop-down list and select **Connected Displays**.

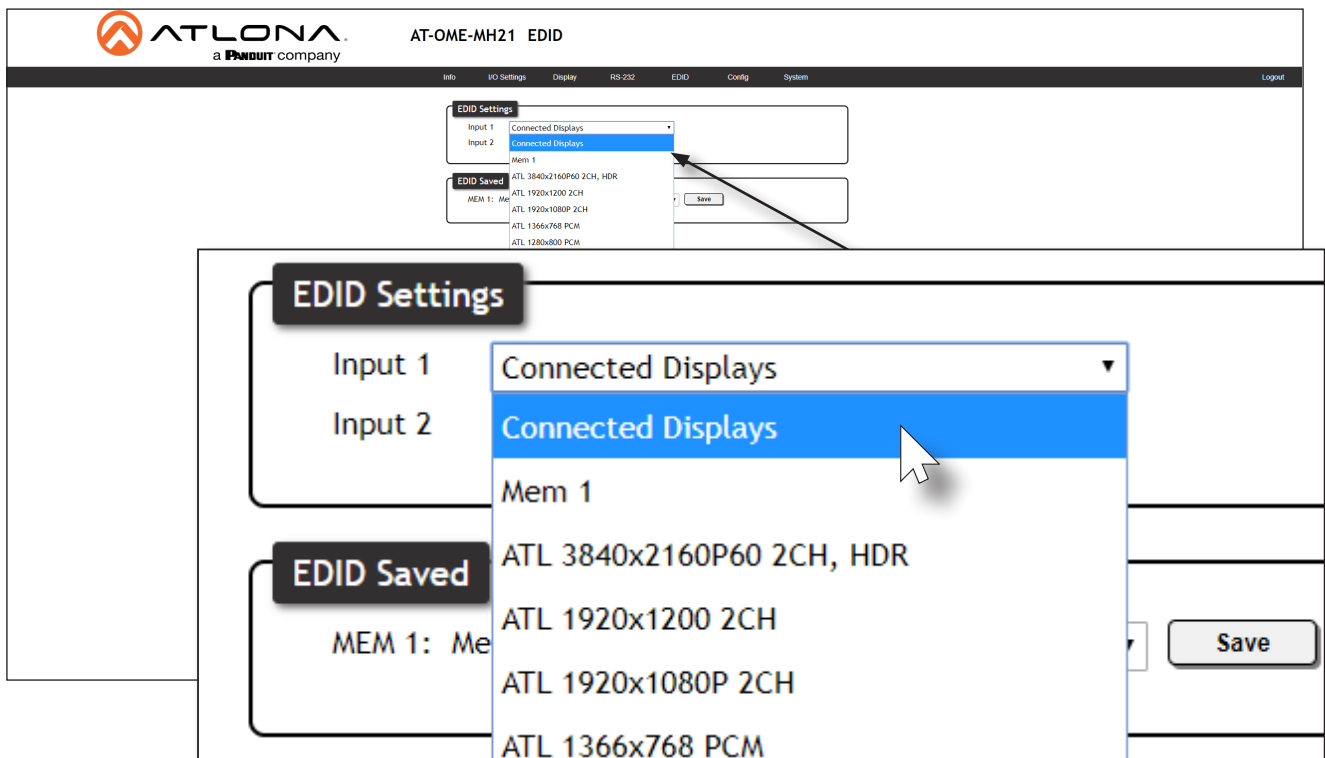

5. Downstream EDID configuration is complete.

EDID Presets

The AT-OME-MH21 provides the option of selecting a preset EDID. The following presets are available. For information on the **Mem 1** setting, refer to [Storing EDID Data \(page 30\)](#).



IMPORTANT: If problems are encountered when using an EDID preset, try using the default setting of **Connected Displays**.

EDID Preset	
Connected Displays	The default setting; uses the EDID of the connected display
Mem 1	EDID memory storage
ATL 3840x2160P60 2CH, HDR	3840 x 2160 @ 60 Hz with two-channel audio and HDR support
ATL 1920x1200 2CH	1920 x 1200 @ 60 Hz with two-channel audio support.
ATL 1920x1080P 2CH	1920 x 1080 @ 60 Hz with two-channel audio support.
ATL 1366x768 PCM	1366 x 768 @ 60 Hz with two-channel audio support.
ATL 1280x800 PCM	1280 x 800 @ 60 Hz with two-channel audio support.
ATL 1280x720 PCM	1280 x 720 @ 60 Hz with two-channel audio support.
ATL 1024x768 PCM	1024 x 768 @ 60 Hz with two-channel audio support.

1. Login to the web server. Refer to [Web Server \(page 20\)](#) for more information.
2. Click **EDID** in the menu bar.
3. Locate the **EDID Settings** section.
4. Click the drop-down list, next to the port that is connected to the display device, and select the desired EDID preset. For example, to have the **USB-C 1** port use a specific EDID, click the **Input 1** drop-down list.

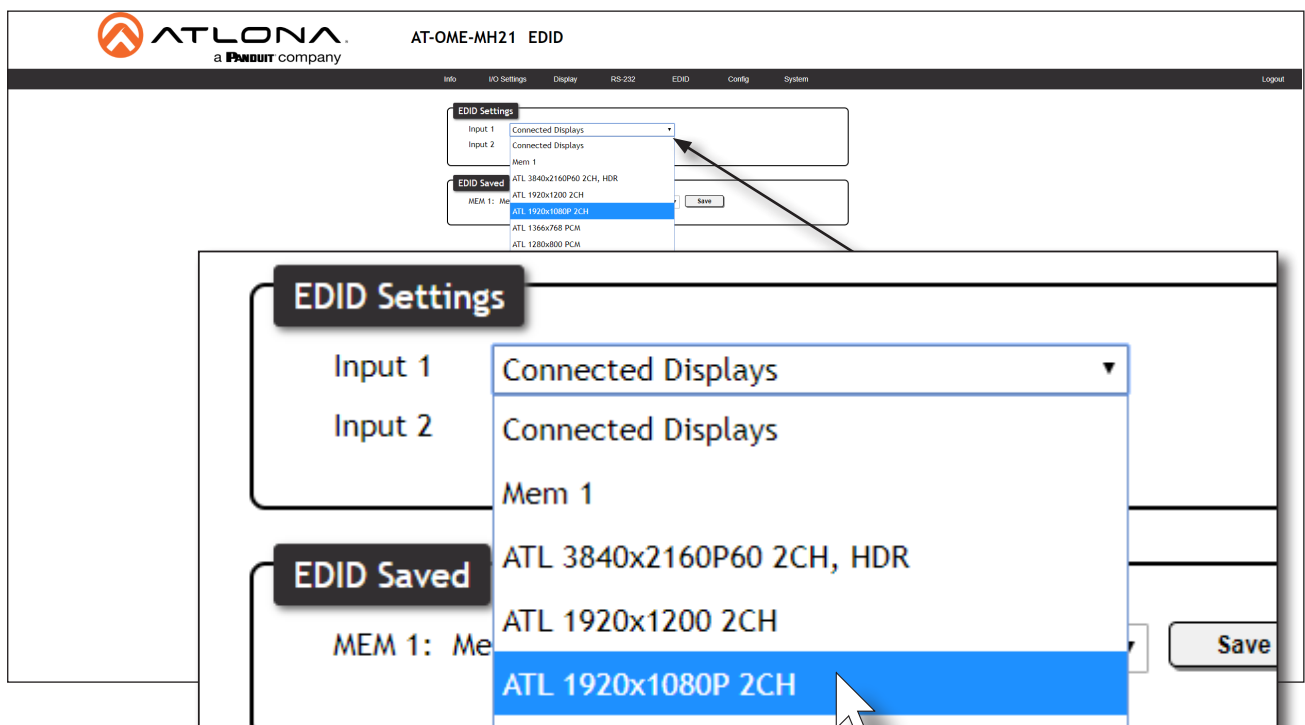

The screenshot displays the AT-OME-MH21 EDID configuration page. At the top, the ATLONA logo and 'a PANOUT company' are visible. The page title is 'AT-OME-MH21 EDID'. A navigation bar includes 'Info', 'I/O Settings', 'Display', 'RS-232', 'EDID', 'Config', and 'System'. The main content area is titled 'EDID Settings' and shows two input sections: 'Input 1' and 'Input 2', both currently set to 'Connected Displays'. Below this, the 'EDID Saved' section lists several presets: 'ATL 3840x2160P60 2CH, HDR', 'ATL 1920x1200 2CH', 'ATL 1920x1080P 2CH' (which is highlighted in blue), 'ATL 1366x768 PCM', and 'ATL 1280x800 PCM'. A 'Save' button is located to the right of the list. A mouse cursor is pointing at the 'ATL 1920x1080P 2CH' option.

5. EDID preset selection is complete.

Storing EDID Data

The AT-OME-MH21 provide a single memory location which can be used to store EDID data. Any downstream EDID can be captured and stored in these locations. The memory location is non-volatile and captured EDID data is retained after power is disconnected from the unit.

1. Connect an HDMI cable from the **HDMI OUT** port on the AT-OME-MH21 to the HDMI input on the display, containing the EDID to be stored.
2. Login to the web server. Refer to [Web Server \(page 20\)](#) for more information.
3. Click **EDID** in the menu bar.
4. Locate the **EDID Saved** section.

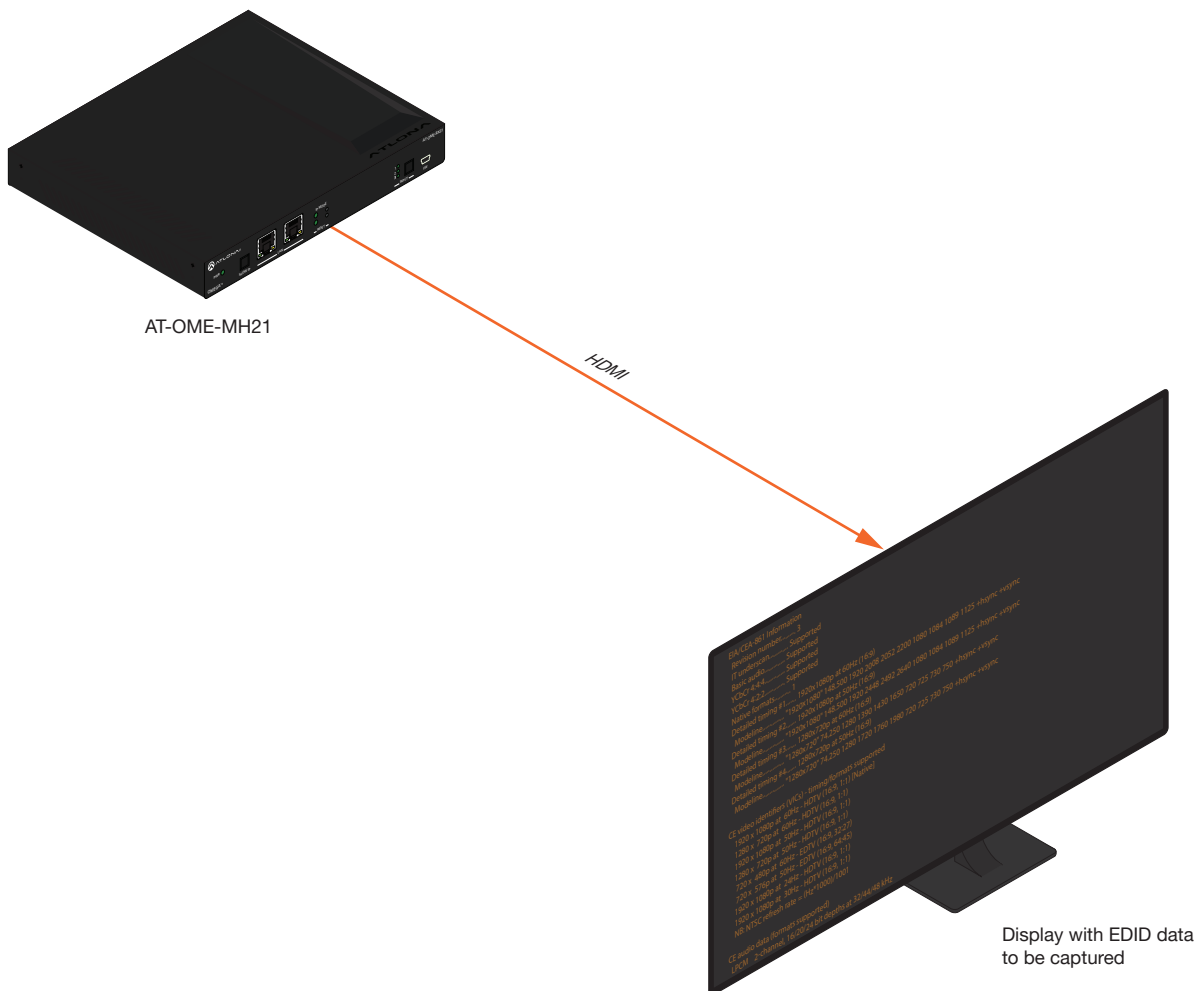

- Click the drop-down list and select **Output 1**, which refers to the HDMI **OUTPUT** port on the AT-OME-MH21.

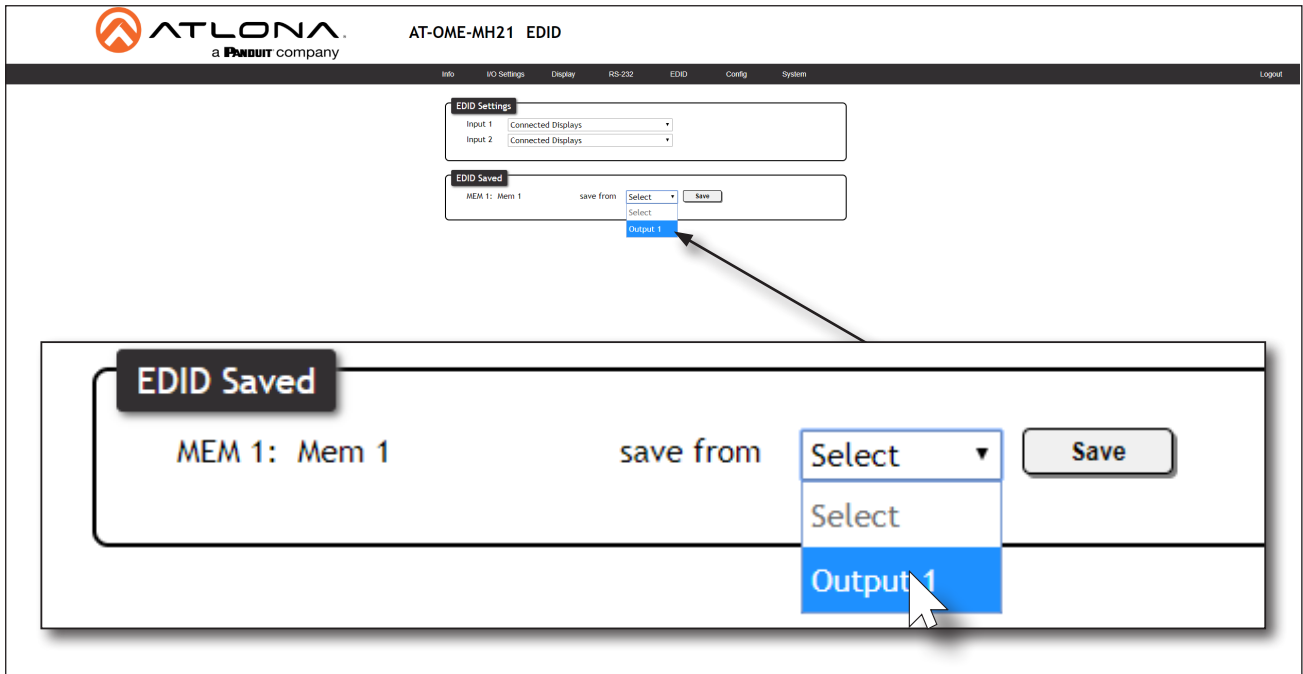

- Click the **Save** button next to the drop-down list for the memory location.



- The saved EDID will appear next to the memory location, as shown below.

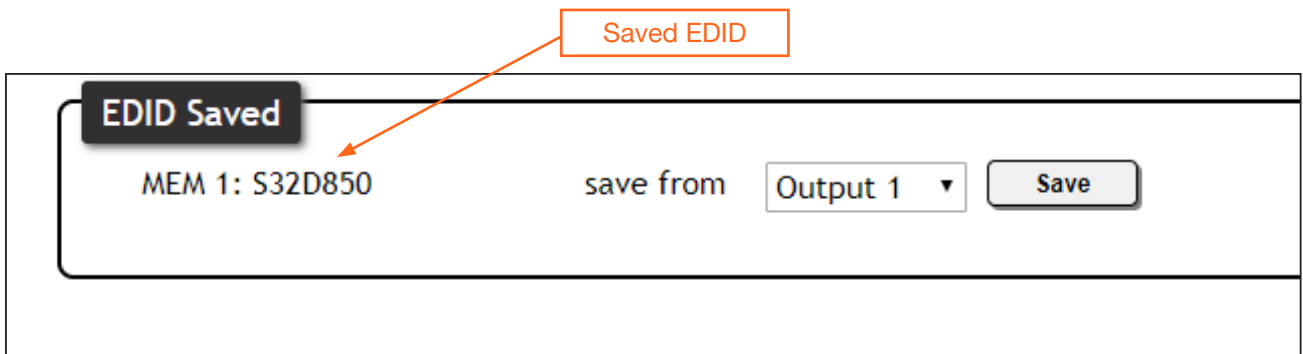

- Click any of the input drop-down list boxes, under the **EDID Settings** window group. Note that the stored EDID appears as an available EDID preset for each available input on the AT-OME-MH21.

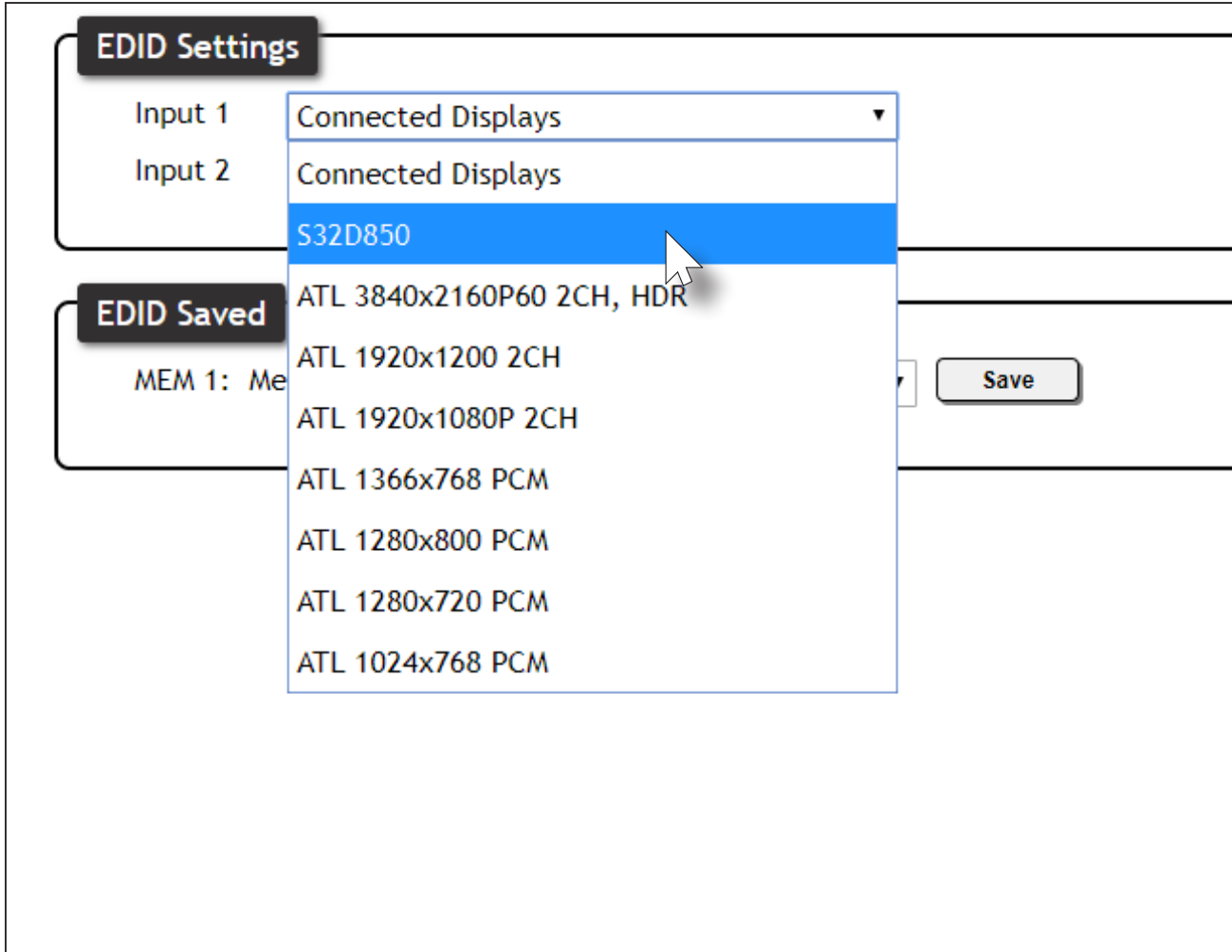

- The EDID storing procedure is completed.



NOTE: Once an EDID is written to a memory location, it can be overwritten with a different EDID, when desired. To overwrite an EDID with a different EDID, repeat steps 5 through 7, above.

User Management

The AT-OME-MH21 allows the administrator password to be changed, as well as the ability to create and remove user accounts.. Passwords apply to both the web server and Telnet sessions. The username for the administrator account cannot be changed.

Changing the Administrator Password

1. Login to the web server. Refer to [Web Server \(page 20\)](#) for more information.
2. Click **Config** in the menu bar.
3. Click the **Old Password** field and enter the current password.

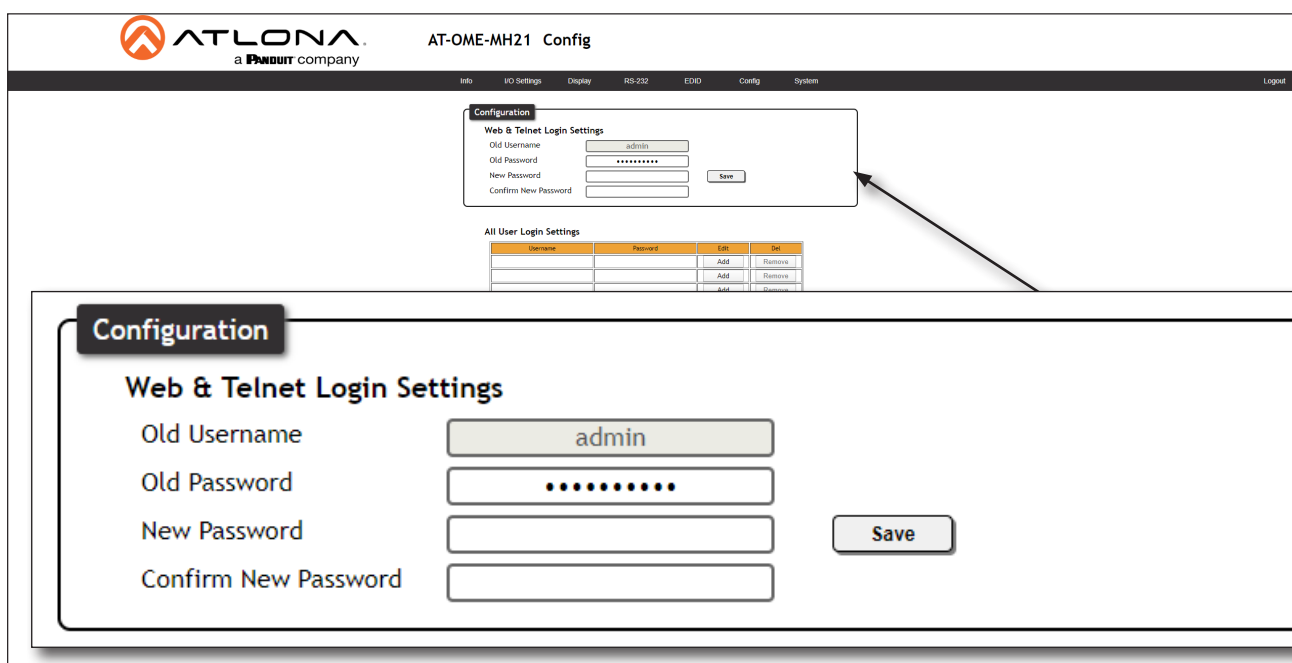

4. Enter the new password in the **New Password** field.
5. Retype the new password in the **Confirm New Password** field.
6. Click the **Save** button to commit changes. To login with the new username, click **Logout** in the upper-right corner of the screen, then enter the new password on the **Login** page.

 **NOTE:** Password fields will always be masked for security purposes.

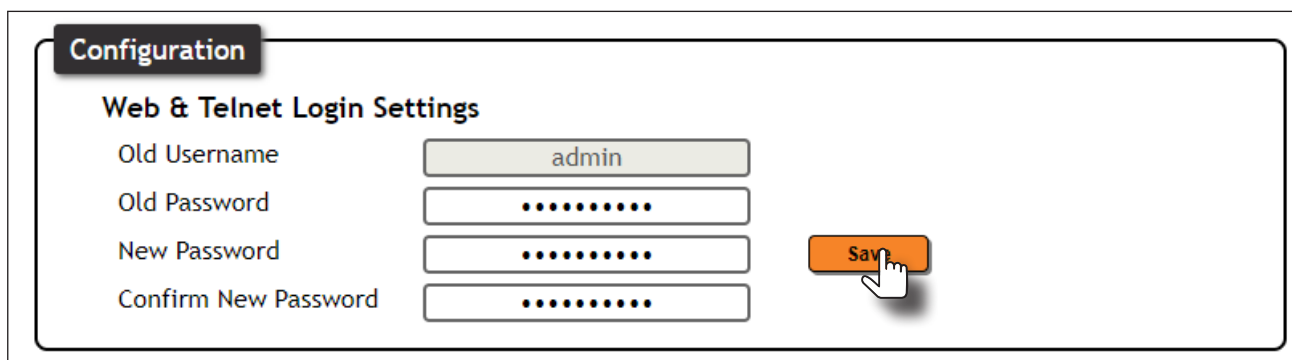

Creating and Deleting User Accounts

1. Login to the web server. Refer to [Web Server \(page 20\)](#) for more information.
2. Click **Config** in the menu bar.
3. Click the **Add** button, under the **Edit** column.

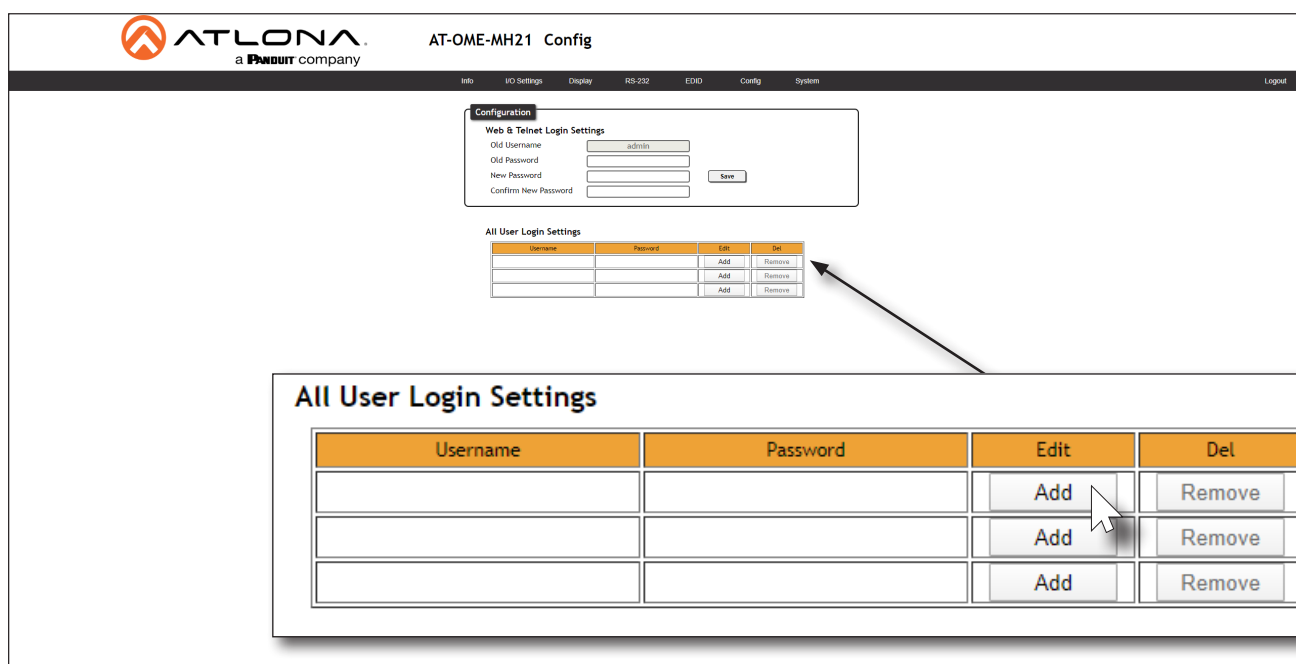

4. Enter the desired username and password in the **Username&Password Edit** dialog box.
5. Click the **Save Change** button to commit changes or click the **Cancel** button to return to the **Config** page without adding the user.

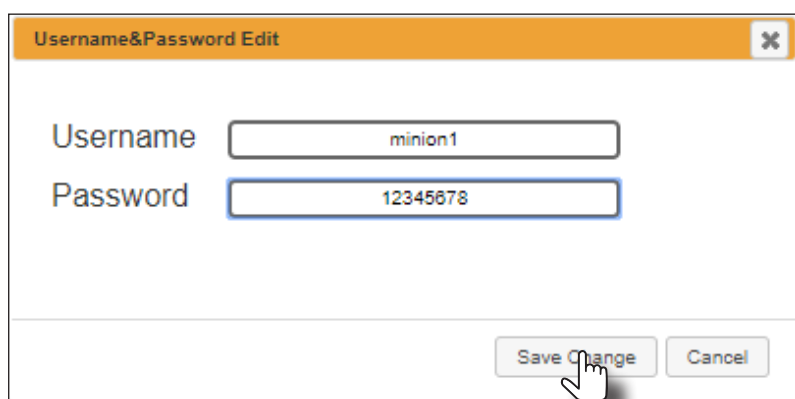

Once created, the new user and the associated password will appear under the **All User Login Settings** section. To login with the new username, click **Logout** in the upper-right corner of the screen, then enter the login credentials for the user on the **Login** page.

6. To delete a user, click the **Remove** button under the **Del** column.

System Configuration

The AT-OME-MH21 provides easy access to system configuration through the built-in web server, and is the recommended method to adjust network settings.

Getting the MAC Address

1. Login to the web server. Refer to [Web Server \(page 20\)](#) for more information.
2. Click **System** in the menu bar.
3. Locate the MAC address field, as shown below. This is the hardware address of the AT-OME-MH21.

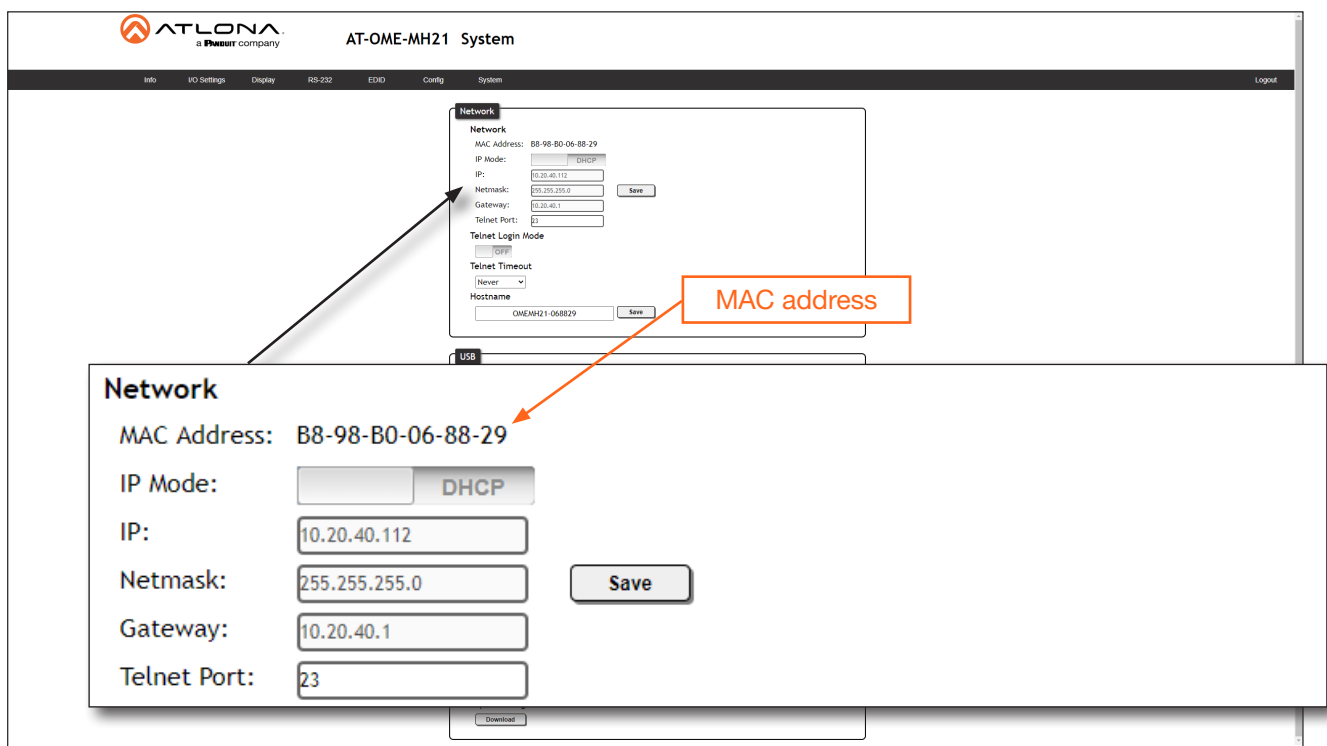

Changing the Telnet Port

Typically, the Telnet service is assigned to TCP port 23. This is the default setting for the AT-OME-MH21. However, depending upon the network environment, the default Telnet port can be changed.

1. Login to the web server. Refer to [Web Server \(page 20\)](#) for more information.
2. Click **System** in the menu bar.
3. Locate the **Telnet Port** field and enter the desired port in the field.
4. Click **Save** to commit changes.

Network

MAC Address: B8-98-B0-06-88-29

IP Mode: DHCP

IP:

Netmask:

Gateway:

Telnet Port:

Telnet Login Mode

When a Telnet session is request, the AT-OME-MH21 provides the option to prompt for user credentials or bypass authentication before the Telnet session begins. This credentials prompt option can enabled or disabled. When prompting for user credentials, use the same login information required by the built-in web server.

1. Login to the web server. Refer to [Web Server \(page 20\)](#) for more information.
2. Click **System** in the menu bar.
3. Click the **Telnet Login Mode** toggle switch.
 - Set this toggle switch to **ON** to prompt for user credentials.
 - Set this toggle switch to **OFF** to bypass user credentials request.
4. Click **Save** to commit changes.

Gateway:

Telnet Port:

Telnet Login Mode

ON OFF

Telnet Timeout

Adjusting Telnet Timeout

When a Telnet session is active, the AT-OME-MH21 can be set to monitor Telnet activity. If there is no activity within the specified time interval, the Telnet session will automatically be terminated, adding a measure of security.

1. Login to the web server. Refer to [Web Server \(page 20\)](#) for more information.
2. Click **System** in the menu bar.
3. Click the **Telnet Timeout** drop-down list and select the desired time-out interval. Values from 10 to 3600 seconds can be selected.



IMPORTANT: If **Never** is selected, then the Telnet port will stay open until the Telnet session is manually terminated.

4. Click **Save** to commit changes.

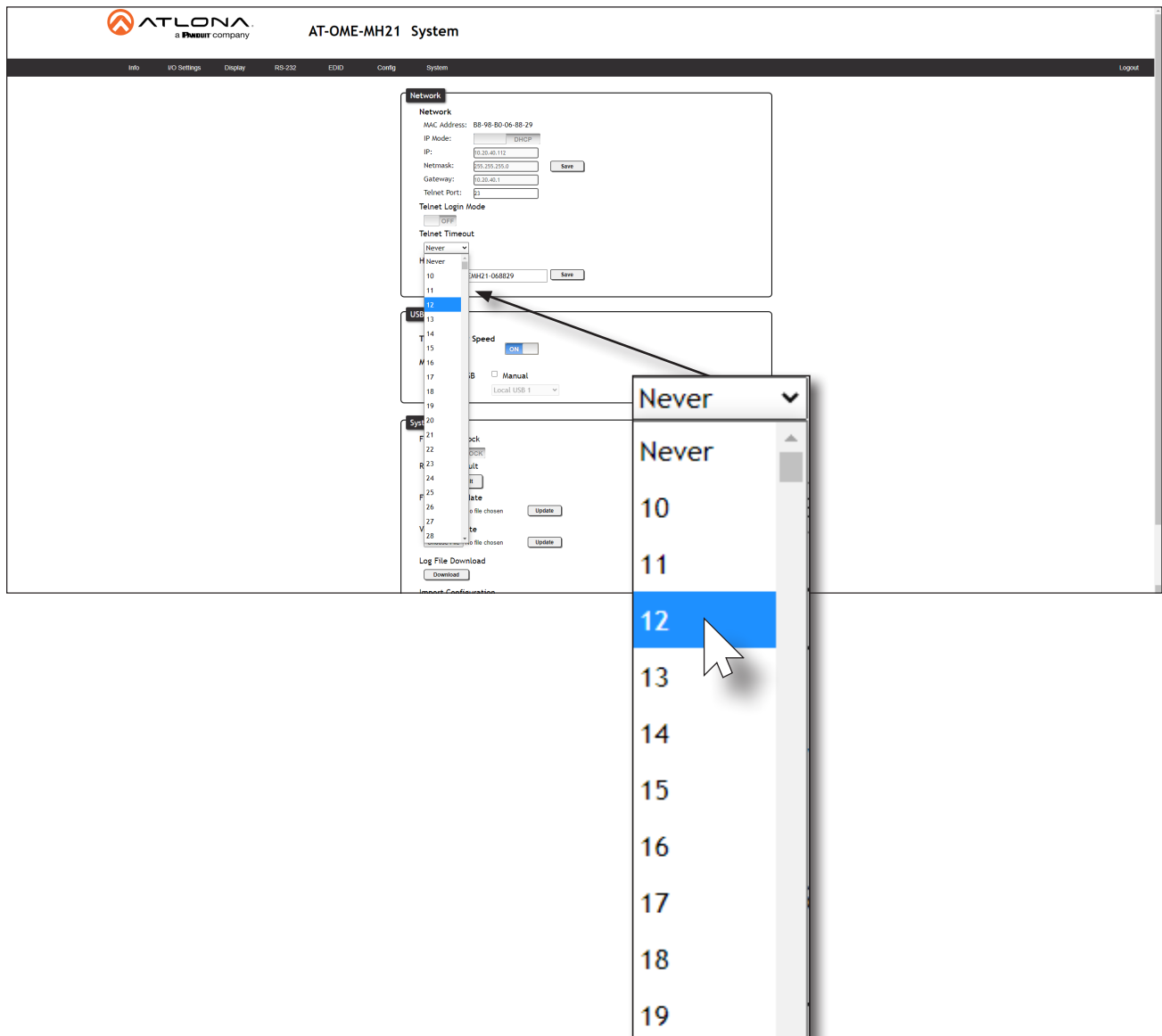

Setting the Host Name

By default, the AT-OME-MH21 is assigned a hostname, which is constructed as follows:

OMEMH21-[last six digits of MAC address]

For example, a default hostname might look like this: OMEMH21-00021B. This value can be changed to easily identify the AT-OME-MH21 within the Atlona Management System (AMS) or a network. If using a custom hostname, it must meet the hostname standards, defined here: <https://tools.ietf.org/html/rfc1123>

1. Login to the web server. Refer to [Web Server \(page 20\)](#) for more information.
2. Click **System** in the menu bar.
3. Click the **Hostname** field and enter the desired name.
4. Click **Save** to commit changes.

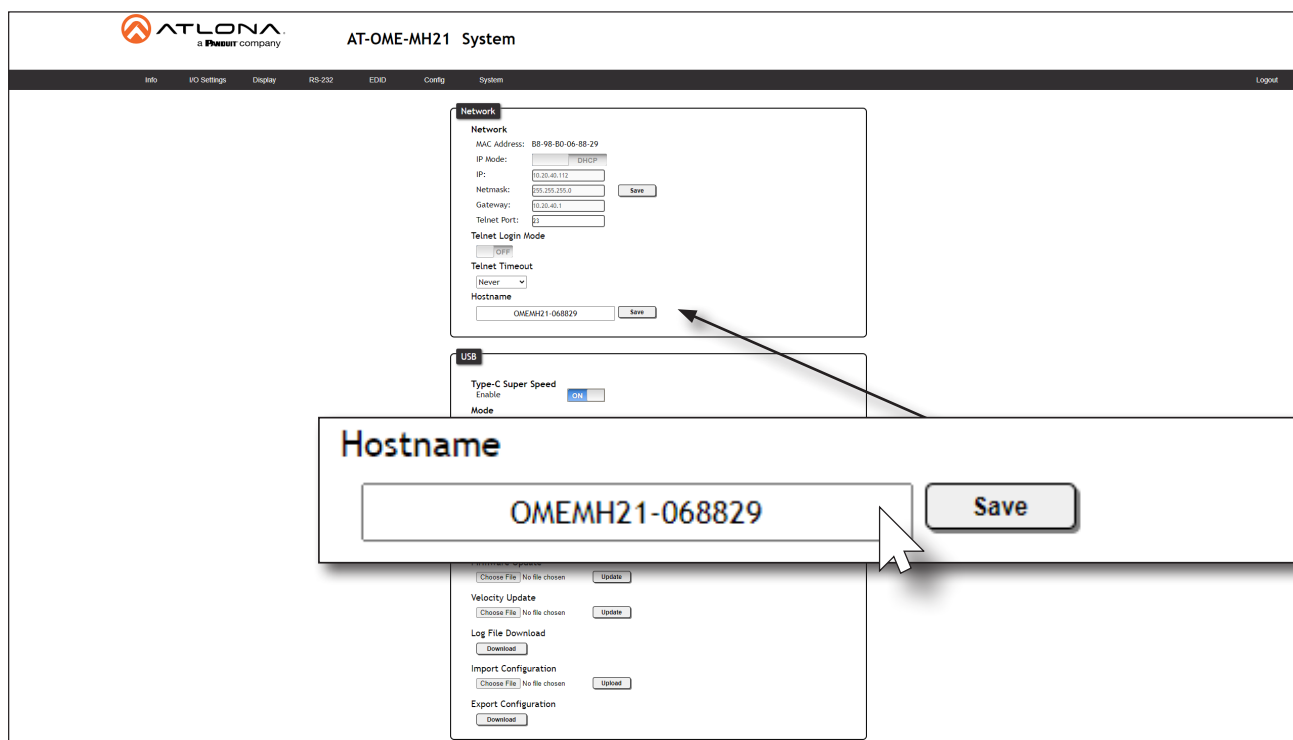

Locking / Unlocking the Front Panel

To prevent accidental pressing of the front panel buttons, the front panel buttons can be locked. This may be desirable if, for example, the AT-OME-MH21 is installed in a rack environment. By default, the front panel buttons are unlocked.

1. Login to the web server. Refer to [Web Server \(page 20\)](#) for more information.
2. Click **System** in the menu bar.
3. Click the **Front Panel Lock** toggle switch to lock the buttons on the front panel. When the front panel is locked, the toggle switch will display the **LOCK** setting.



4. To unlock the front panel, click the **Front Panel Lock** toggle switch again to set it to **UNLOCK**.

Resetting to Factory-Default Settings

The following procedure will reset the AT-OME-MH21 to factory-default settings. The network IP mode will be set to DHCP mode.

1. Login to the web server. Refer to [Web Server \(page 20\)](#) for more information.
2. Click **System** in the menu bar.
3. Click the **Factory Default** button.

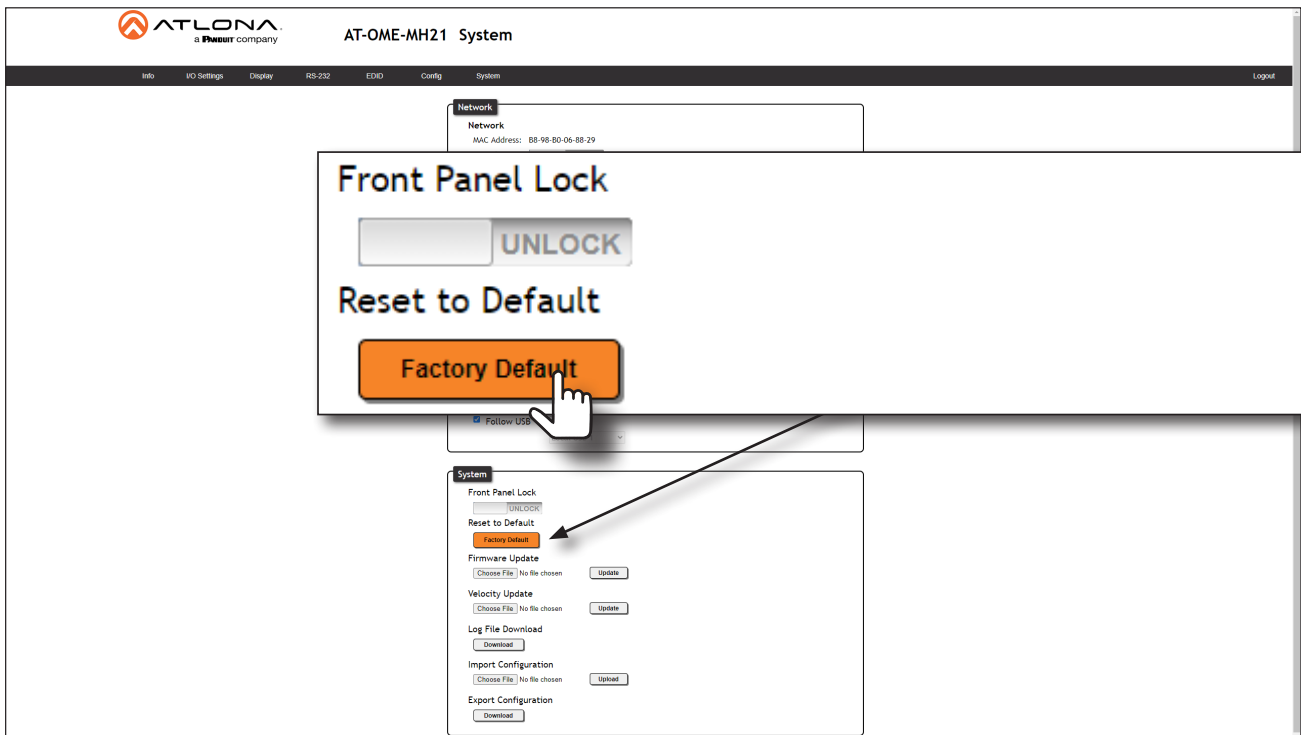

4. The following message will be displayed at the top of the screen. Click **OK** to continue with the factory-default reset procedure. Click **Cancel** to abort the process.



5. Once the factory-default process is complete, the web server **Login** screen will be displayed.
6. The reset process is complete.

Downloading System Configuration

The AT-OME-MH21 allows the current system configuration to be downloaded to the connected computer, in .json format. Multiple configurations can be saved and then restored at any time. Refer to [Restoring System Configuration \(page 42\)](#) for more information.

1. Login to the web server. Refer to [Web Server \(page 20\)](#) for more information.
2. Click **System** in the menu bar.
3. Click the **Download** button.

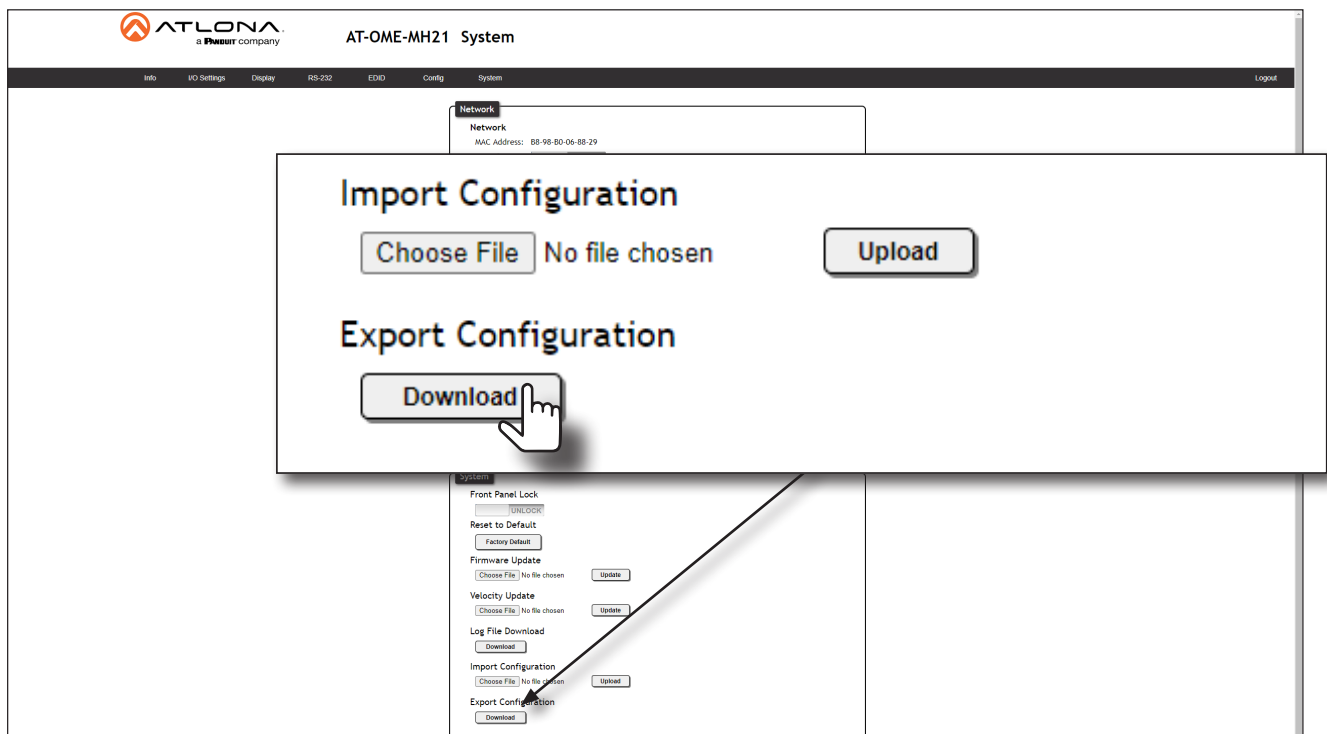

4. After a few moments, the **Save As** dialog will be displayed. The filename name field will be automatically be filled in with the a default filename, similar to: AT-OME-MH21_OMEMH21-068829.json. The filename can be changed, but the file extension of .json must exist. The OMEMH21-068829 portion of the filename is the unit host name.
5. Click the **Save** button to save the file to the desired folder on the computer.

Restoring System Configuration

Once a system configuration has been saved as an .json file, the file can be uploaded to the AT-OME-MH21, allowing a system configuration to be restored. Both the **Export Configuration** and **Import Configuration** feature are useful for saving and loading different configurations and/or to provide a backup, in the unlikely event of a system failure. When a system configuration file is uploaded, it will overwrite the current settings.



IMPORTANT: IP Mode information is stored as part of the configuration file. Therefore, caution should be exercised when sharing configuration files between multiple AT-OME-MH21 units. If the unit is set to *static* IP mode, then restoring multiple units with the same configuration file will result in the same IP address being shared between multiple units, causing an IP conflict on the network.

1. Login to the web server. Refer to [Web Server \(page 20\)](#) for more information.
2. Click **System** in the menu bar.
3. Click the **Choose File** button, under **Import Configuration**.



4. The **Open** dialog will be displayed. Select the desired system configuration file. Once the file is selected, the selected filename will appear next to the **Choose File** button.
5. Click the **Upload** button to upload the configuration file to the AT-OME-MH21. The following warning message will be displayed:

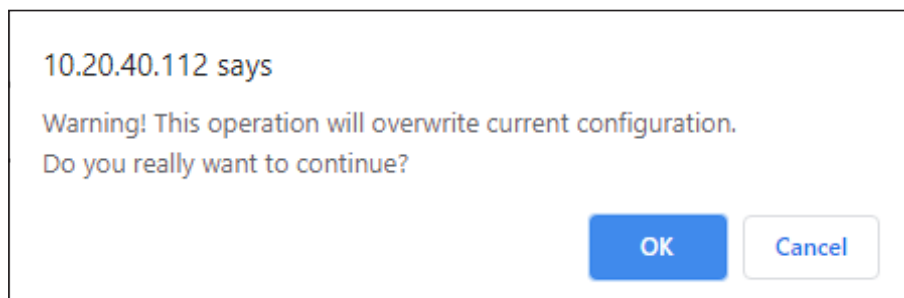

6. Click the **OK** button to continue or click **Cancel** to abort the operation.
7. One the upload has started, a progress message will be displaying the restore process.
8. The restoration process is complete.

USB Modes

USB-C Super Speed Mode

The USB-C port can be set to enable or disable USB SS (Super Speed) mode. Enabling USB SS mode provides data rates up to 5 Gbit/s (625 MB/s), allowing a maximum resolution of 4096x2048 @ 30 Hz RGB. USB SS mode is enabled by default.

1. Login to the web server. Refer to [Web Server \(page 20\)](#) for more information.
2. Click **System** in the menu bar.
3. Click the **Enable** toggle, under **Type-C Super Speed**, to the **ON** position to enable USB SS mode. Click this toggle switch to the **OFF** position to disable USB SS mode.

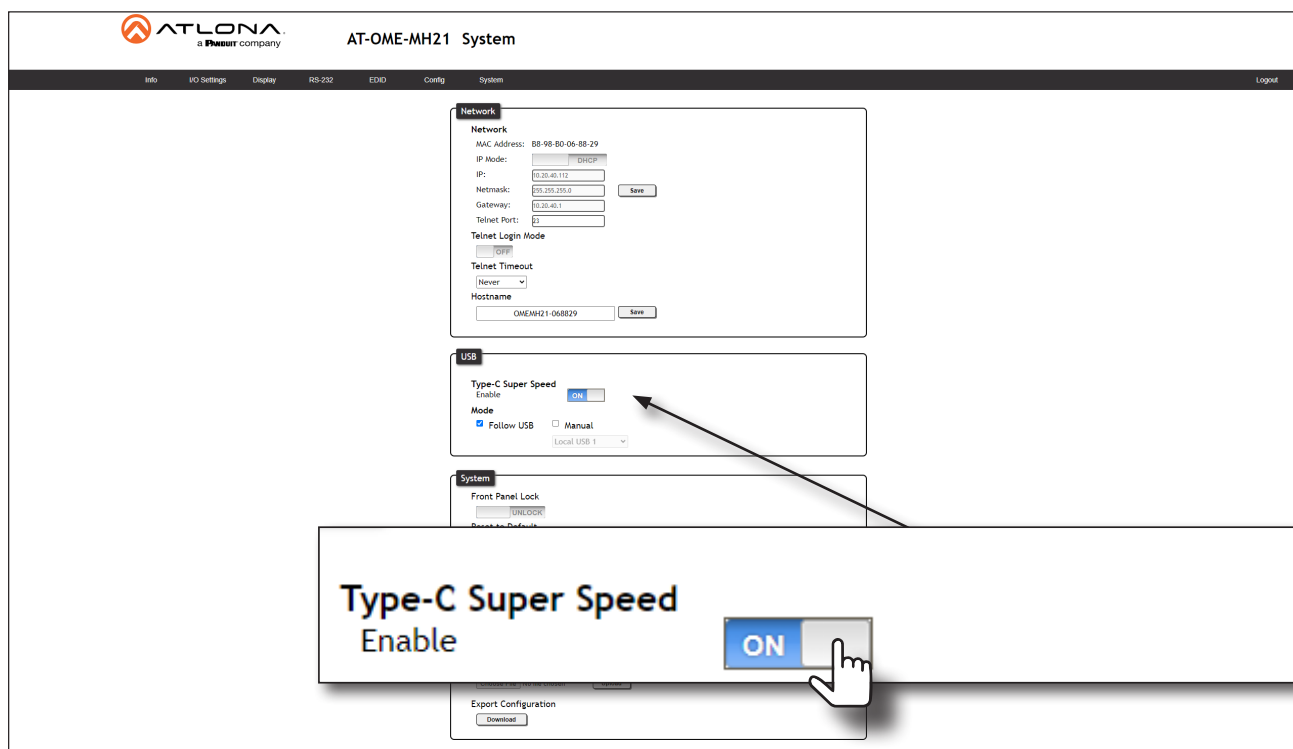

Follow USB Mode

This is the default mode and functions similar to auto-switching for video. In this mode, the AT-OME-MH21 will detect which USB ports are connected to a host device. If both USB host ports are connected to host devices, then the AT-OME-MH21 will set the last-connected USB host device as the “active” USB host. Use the procedure below to enable Follow USB mode.

1. Connect the host computers to the USB host ports, as desired. Note that it is not required that both the HOST USB and USB-C ports be connected to host devices.

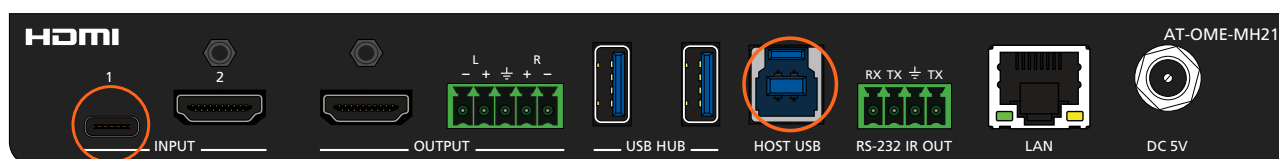

2. Login to the web server. Refer to [Web Server \(page 20\)](#) for more information.
3. Click **System** in the menu bar.
4. The **Follow USB** check box should already be checkmarked, indicating that the feature is enabled. If not, click this check box enable **Follow Video** mode.

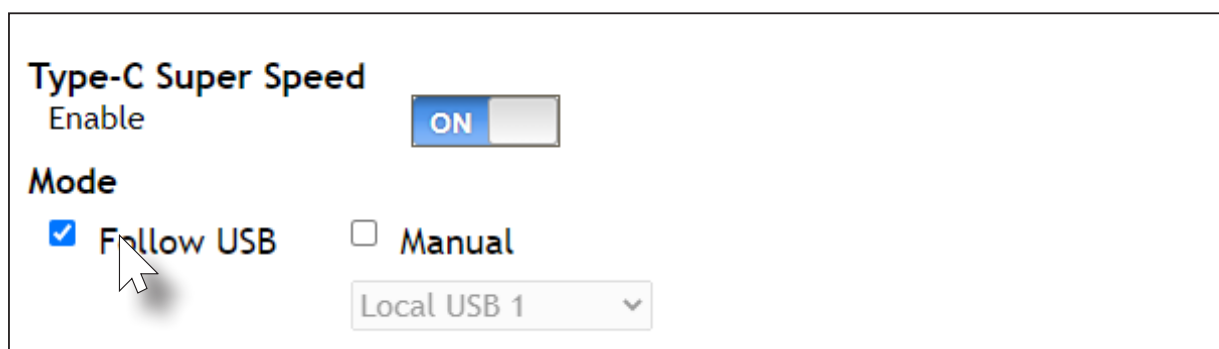

Once set to **Follow USB** mode, the AT-OME-MH21 will exhibit the following behavior:

- If only one USB host port is connected, then the AT-OME-MH21 will use the USB host device connected to that port.
- If an another USB host device is connected to the vacant USB port, then the AT-OME-MH21 will automatically switch to that USB host device.
- If *both* **HOST USB** and **USB-C** ports are connected, then the AT-OME-MH21 will switch to the USB port that was connected *last*.
- If *both* **HOST USB** and **USB-C** host ports are connected, and one USB host port is disconnected, then the AT-OME-MH21 will automatically switch to the opposite USB host port.

5. Follow USB configuration is complete.

Manual Mode

This mode provides manual selection of the USB host port to be used.

1. Connect the host computers to the USB host ports, as desired. Note that it is not required that both USB host ports be connected to host devices.

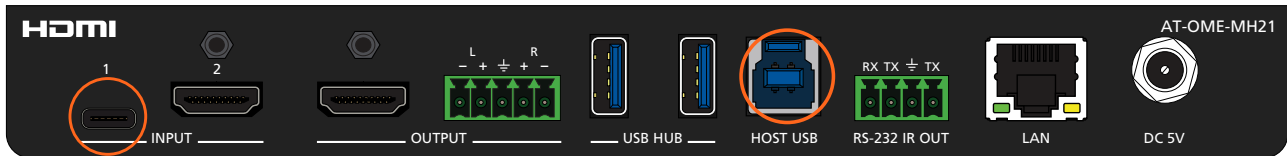

2. Login to the web server. Refer to [Web Server \(page 20\)](#) for more information.
3. Click **System** in the menu bar.
4. Click the **Manual** check box.
5. Click the drop-down list, under the **Manual** check box and select the desired USB port.

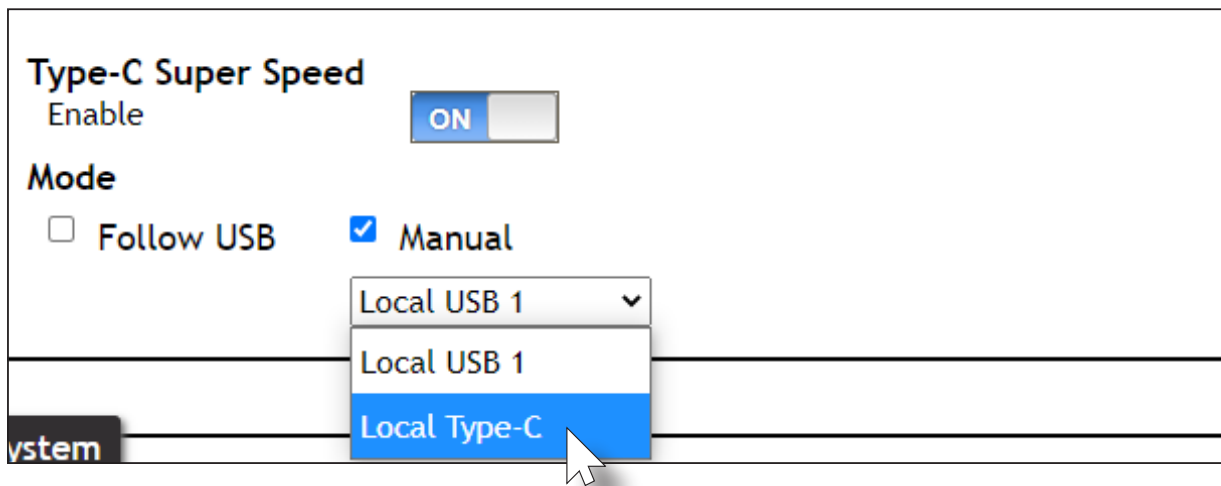

6. Manual USB configuration is complete.

Configuration and Management Interfaces

Info Page

The **Info** page provides various information about the AT-OME-MH21, including software version and video information.

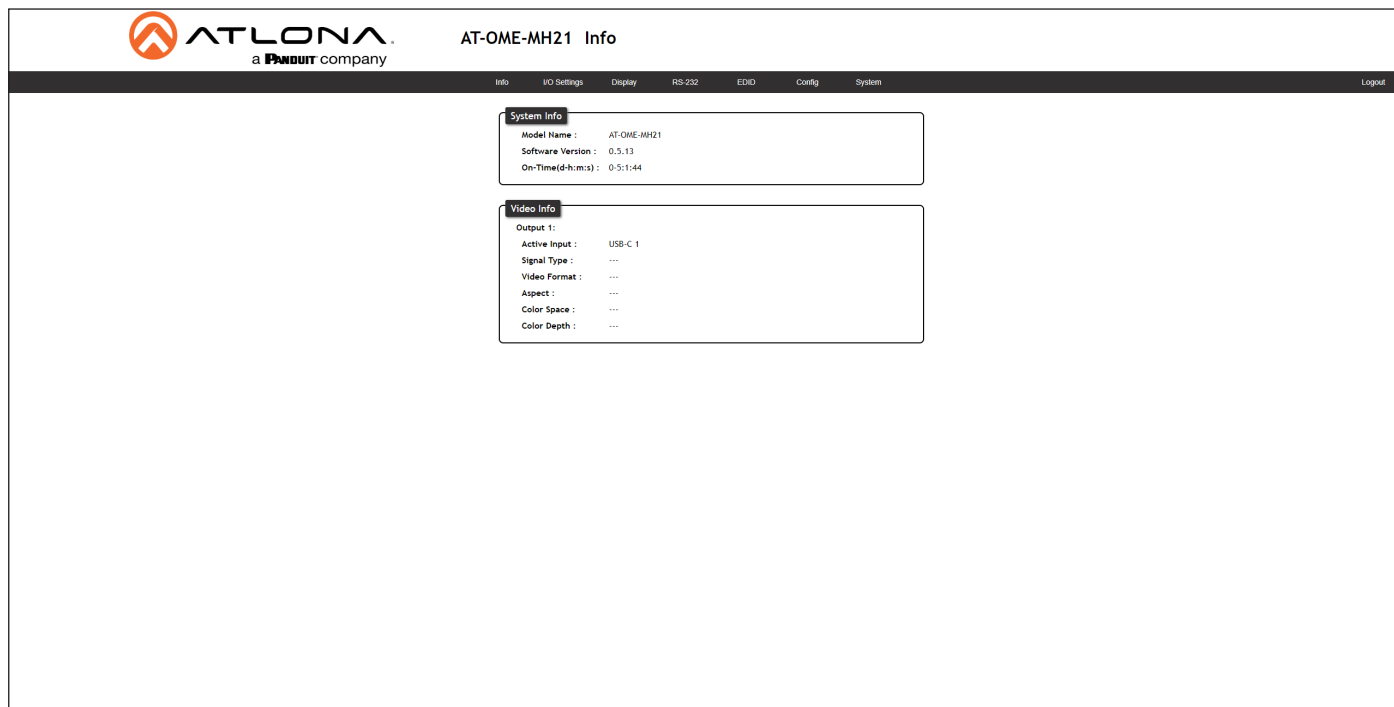

Model Name

The model SKU of this product.

Software Version

The version of firmware that the AT-OME-MH21 is running. Always make sure to check the AT-OME-MH21 product page, on the Atlona web site, for the latest version of firmware.

On-Time(d-h:m:s)

Displays how long the system has been powered since the last reboot/reset.

Active Input

The currently selected (active) input.

Signal Type

The type of input signal.

Video Format

The input resolution of the source device.

Aspect

Aspect ratio of the input signal.

Color Space

Displays the color space and chroma sub-sampling of the input signal.

Color Depth

The color depth of the input signal.

I/O Settings Page



Auto Switch

Click this toggle switch to enable or disable auto-switching. When enabled, the AT-OME-MH21 will automatically switch to the another input, if the signal is disrupted on the currently active input.

Input Selection

Click this drop-down list to manually select the desired input.

Input	Description
USB-C 1	Sets INPUT 1 as the active input.
HDMI 2	Sets INPUT 2 as the active input.
A/V Mute	Mutes both audio and video on the output.

Audio

Manages audio settings for inputs and outputs.

- HDMI**
 Set this toggle to the **ON** position to mute the audio on the output. The default setting is **OFF**.
- Analog**
 Set this toggle to the **ON** position to mute the audio on the **ANALOG** output. The default setting is **OFF**.

Scaler

Click this toggle switch to enable or disable the scaler pass-through feature. When set to the **ON** position, 4K content will be down-scaled to 1080p. When set to the **OFF** position, the output resolution / timing will be the same as the input source. The default setting is **ON**.

Configuration and Management Interfaces

HDCP

Each input provides control of how HDCP content is handled. Some source devices will send HDCP content if an HDCP-compliant display (sink) is detected. However, there may be applications where sending HDCP content is not desired. Setting the port to the **OFF** position, will instruct the source to send non-HDCP content to the display. Note that not all sources have this capability.



NOTE: Setting this feature to **OFF**, for any source, does *not* provide decryption of HDCP content to non-HDCP compliant sink devices. Sources such as Mac[®] computers and the Sony PlayStation[®] will *always* transmit HDCP content.

- **ON**
When set to **ON**, the source will have the ability to transmit HDCP content to the AT-OME-MH21.
- **OFF**
When set to **OFF**, non-HDCP content will be transmitted (if possible) to the AT-OME-MH21.

Display Page

This page provides controls for CEC, device timers, and configuration for controlling external devices.

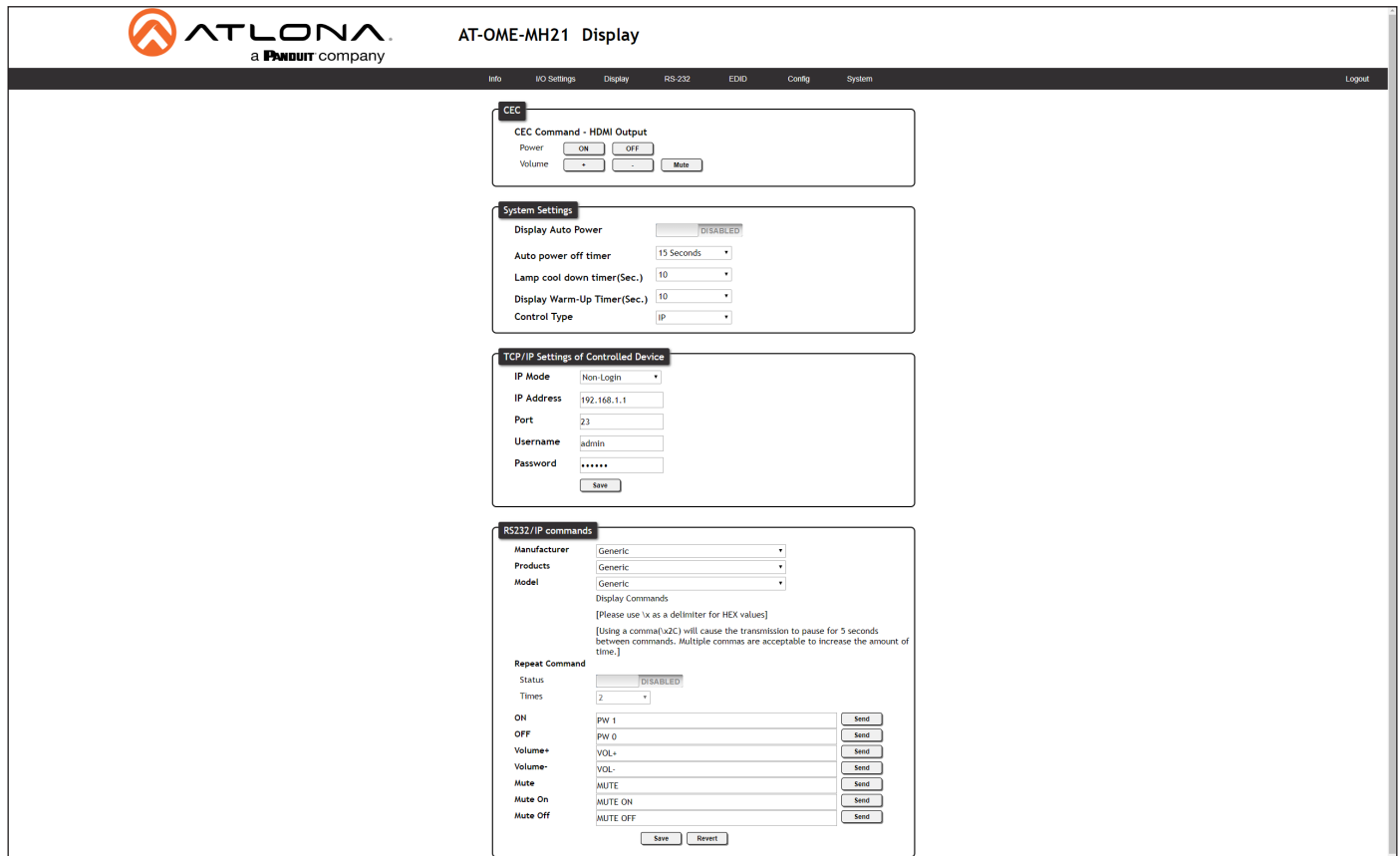

CEC Command - HDMI Output

- Power**
 Click the **ON** button to send the power-on command to the display device. Click the **OFF** button to toggle the power state to off.
- Volume**
 Click the + or - button to increase or decrease the output volume, respectively. Click the **Mute** button to mute the audio.

Consumer Electronics Control (CEC) Note: Atlona has confirmed proper CEC functionality with several current models of Samsung, Panasonic, and Sony displays. However, it is not guaranteed that CEC will work with all displays. Many manufacturers do not support the CEC “off” command, and older displays use proprietary commands. Atlona only supports displays that use the CEC command structure defined in HDMI 1.2a. It is recommended that dealers request an evaluation product from Atlona, before designing a system using the CEC protocol. If this is not possible, then other control methods will need to be considered, in order to control displays using Atlona products.

Display Auto Power On

Set this toggle to **ENABLED** to allow the AT-OME-MH21 to send the power-on command to the display when an A/V signal is detected. When the AV signal is no longer present, the AT-OME-MH21 will send the power-off command to the display. If this feature is not desired, then set to **DISABLED**. This feature is disabled by default.

Auto power off timer

Sets the time interval before the command to power-off the display is sent, when an A/V signal is no longer present. The default value is 15 seconds. Available values are 5 seconds to 1 hour.

Configuration and Management Interfaces

Lamp cool down timer (Sec.)

Sets the projector lamp cool-down timer, in seconds. This value specifies the time interval that must elapse, after the display control “off” command is sent, before the display “power on” command can be sent. This feature is used to prevent the projector from missing a “power on” command while the lamps are cooling. Available values are 10 to 300 seconds. The default setting is 10 seconds.

Display Warm-Up Timer (Sec.)

Sets the projector lamp warm-up timer, in seconds. During the warm-up interval, the AT-OME-MH21 will not start the auto power-off timer. This value specifies the time interval that must elapse, after the display control “on” command is sent, before the display “power off” command can be sent. This feature is used to prevent a “power off” command from being sent while the lamps are warming up. Available values are 10 to 300 seconds. The default value is 10 seconds.

Control Type

Sets the control protocol for the connected display. Click this drop-down to select the control type. Available settings are **RS-232**, **IP**, **CEC**, and **IR**. By default, CEC is selected for control of the display. When IP, RS-232, or IR is selected, more fields are displayed.

TCP/IP Settings of Control Device

This window group is only available if the **Control Type** drop-down list is set to **IP**.

IP Mode

Click this drop-down list to select the login mode.

Setting	Description
Non-login	Does not require a username and password when using TCP/IP to control the display.
Login	Requires a username and password to control the display through TCP/IP.

IP Address

Enter the IP address of the device in this field.

Port

Enter the listening port of the device in this field.

Username

Enter the username for login. If the **IP Mode** is set to **Non-Login**, then this information will not be required.

Password

Enter the password for login. If the **IP Mode** is set to **Non-Login**, then this information will not be required.

Save

Click this button to save all changes in this window group.

Configuration and Management Interfaces

RS-232/IP commands

This section is only available when the **Control Type** is set to either **RS-232** or **IP**.

Manufacturer

Click this drop-down list to select the display manufacturer. If the display device being controlled is not in this list, then select **Generic** and enter the commands manually.

Generic	Hitachi	Qomo
Acer	Infocus	Samsung
Barco	LG	Sharp
Benq	NEC	Sony
Canon	Optima	Toshiba
Casio	Panasonic	ViewSonic
Eiki	Pjlink	Vivitek
Epson	Planar	

Products

Click this drop-down list to select the product. The options available within this drop-down list are dependent upon the selected value in the **Manufacturer** drop-down list.

Model

Click this drop-down list to select the model. The options available within this drop-down list are dependent upon the selected value in the **Products** drop-down list.

Repeat Command

- Status**
 Click this toggle switch to set to **ENABLE** or **DISABLED**. Enabling this feature will re-send the command. Specify the number of times that the command is transmitted by setting the **Times** value. This feature is set to **DISABLED** by default.
- Times**
 Click this drop-down list to specify the number of times the command is sent. When the **Status** toggle switch is set to **ENABLE**, the default number of times is set to 2.

ON, OFF, Volume+, Volume-, Mute, Mute on, Mute off

These fields will need to be populated with the correct strings (either hex or ASCII format) for each function, which control the display device. If hexadecimal values are used, then use the /x delimiter at the end of the command string.

Save

Click this button to commit changes.

Revert

Click this button to undo changes to any pre-configured strings.

IR commands

This section is only available when the **Control Type** is set to **IR**.



NOTE: Manufacturer IR commands and Pronto codes are supported.

Manufacturer

Click this drop-down list to select the display manufacturer. Over 350 manufacturers are supported. If the display device being controlled is not in this list, then select **Generic** and enter the commands manually.

Products

Click this drop-down list to select the product. The options available within this drop-down list are dependent upon the selected value in the **Manufacturer** drop-down list.

Model

Click this drop-down list to select the model. The options available within this drop-down list are dependent upon the selected value in the **Products** drop-down list.

ON, OFF, Volume+, Volume-, Mute, Mute on, Mute off

These fields will need to be populated with the correct strings (either hex or ASCII format) for each function, which control the display device. If hexadecimal values are used, then use the /x delimiter at the end of the command string.

Save

Click this button to commit changes.

Revert

Click this button to undo changes to any pre-configured strings.

RS-232 Page

This page provides settings for local RS-232 control.

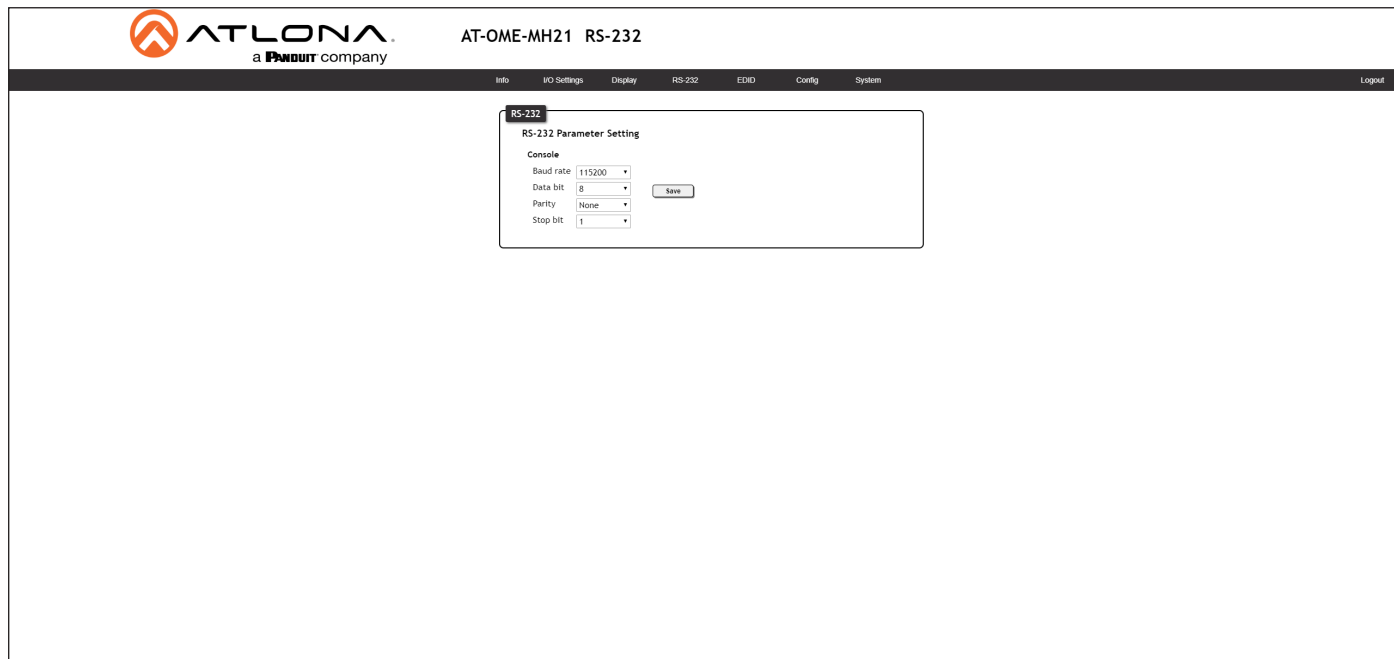

RS-232 Parameter Setting

RS-232 settings for local or HDBaseT RS-232 control.

- **RS232 Console**

Sets the RS-232 port settings used for local control by a third-party control system.

Setting	Description
Baud rate	Sets the baud rate. The following options are available: 2400, 9600, 19200, 38400, 56000, 57600, 115200.
Data bit	Sets the number of data bits used to represent each character of data. The following options are available: 7 or 8.
Parity	Sets the parity bit, which can be included with each character to detect errors during the transmission of data. The following options are available: None, Odd, or Even.
Stop bit	Sets the stop bit. Stop bits are sent at the end of each character, allowing the client to detect the end of a character stream. The following options are available: 1 or 2.

- **Save**

Click this button to commit all changes.

EDID Page

This page provides controls for selecting and storing EDID data. Refer to [EDID Management \(page 28\)](#) for more information.

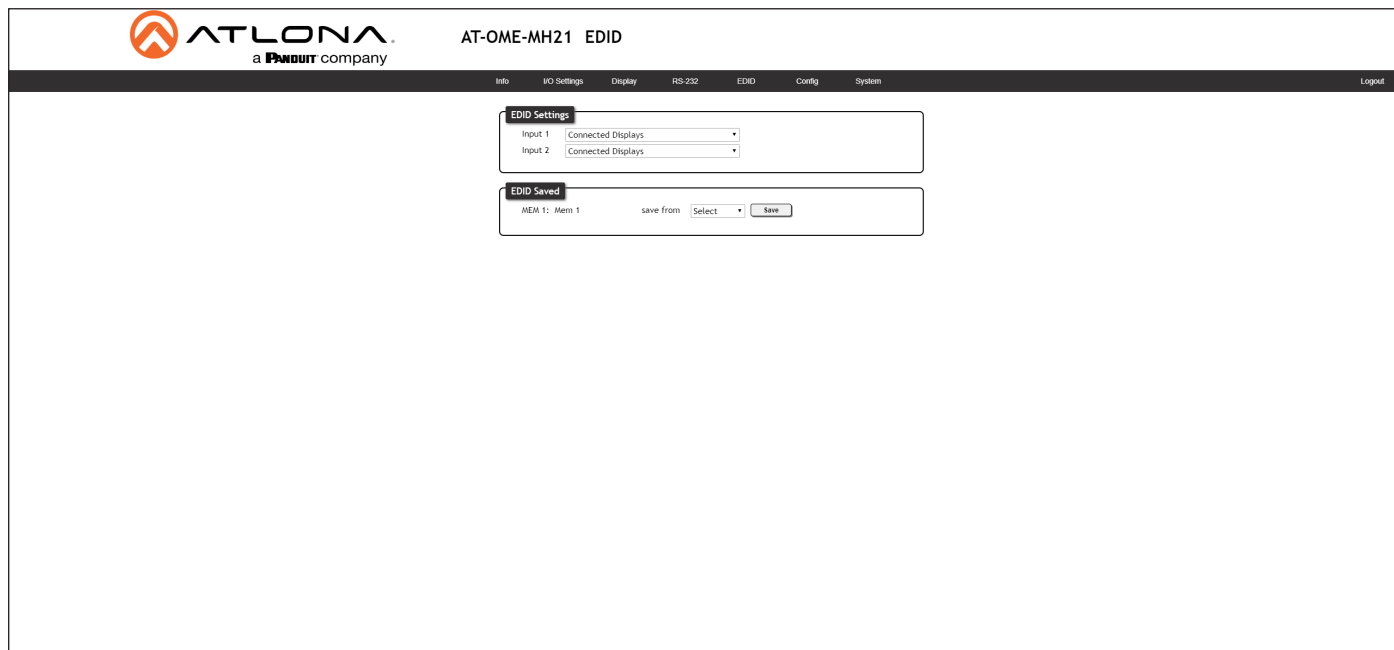

EDID Settings

Click these drop-down lists to select the desired EDID to be used for each input. The following EDID presets are available. When selecting an EDID, make sure that the display/sink device is capable of supporting the resolution/timing. If the sink device is not able to support a feature, then the source will not be displayed. Selecting the **Connected Displays** EDID will provide the most compatible settings for most displays. In addition, three memory locations are available for storing captured EDID data. If an EDID is stored in a memory location, it will also be added to the list available EDID selections.

EDID listing	Description
Connected Displays	Uses the EDID of the connected display
MEM 1	Uses a custom EDID
ATL 3840x2160P60 2CH, HDR	3840x2160 @ 60 Hz, two-channel audio, HDR
ATL 1920x1200 2CH	1920x1200, two-channel audio
ATL 1920x1080P 2CH	1920x1080p, two-channel audio
ATL 1366x768 PCM	1366x768, PCM audio support
ATL 1280x800 PCM	1280x800, PCM audio support
ATL 1280x720 PCM	1280x720, PCM audio support
ATL 1024x768 PCM	1024x768, PCM audio support

EDID Saved

The AT-OME-MH21 provides one memory location for storing captured EDID data. Click this drop-down lists to select and store the external EDID.

Config Page

The **Config** page provides management of the administrator password. The administrator username (“admin”) cannot be changed. Refer to [User Management \(page 33\)](#) for more information.

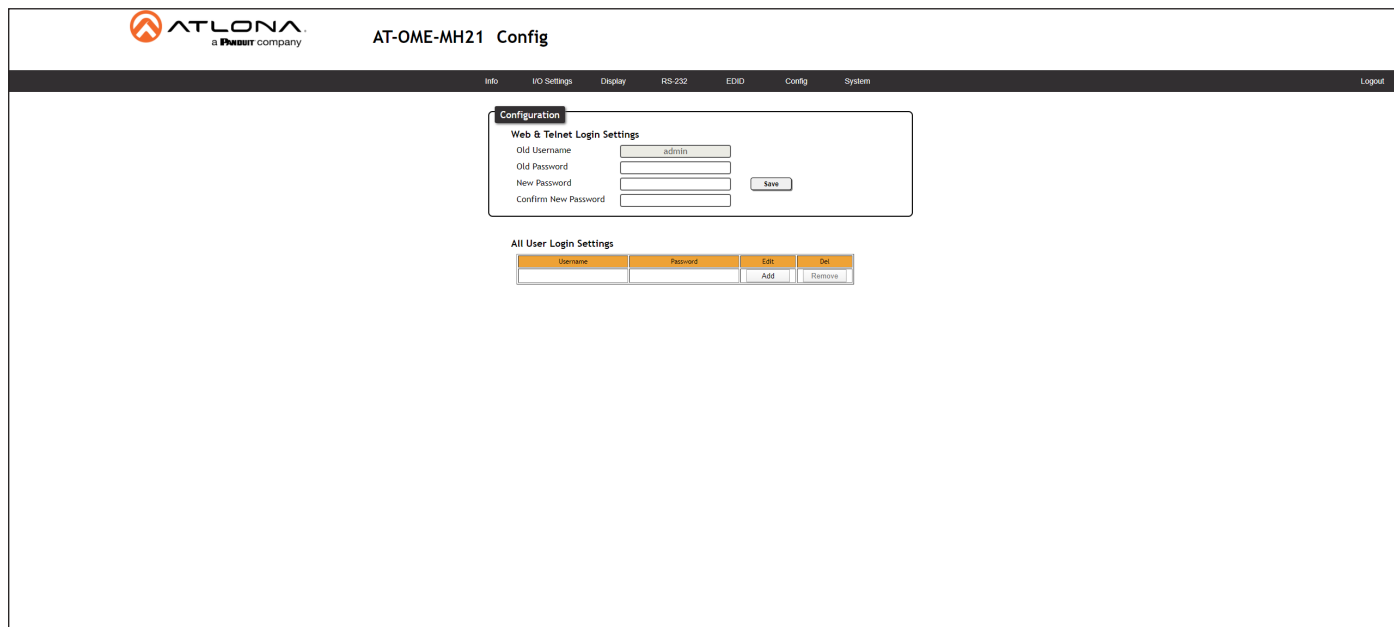

The screenshot shows the AT-OME-MH21 Config page. At the top, there is a navigation bar with the ATLONA logo and the title "AT-OME-MH21 Config". Below the navigation bar, there are several tabs: Info, I/O Settings, Display, RS-232, EDID, Config, System, and Logout. The main content area is titled "Configuration" and contains two sections:

Web & Telnet Login Settings:

- Old Username:
- Old Password:
- New Password:
- Confirm New Password:
- Save:

All User Login Settings:

Username	Password	Edit	Del
		<input type="button" value="Add"/>	<input type="button" value="Remove"/>

Old Username

This field cannot be changed. “admin” is the administrator user.

Old Password

Enter the current password for the “admin” username in this field. The default password is “Atlona”.

New Password

Enter the new password for the “admin” username in this field.

Confirm New Password

Verify the new password by retyping it in this field.

Save

Click this button to commit all changes.

System Page

The **System** page is divided into two sections: **Network** and **System**. The **Network** section allows configuration of the IP settings of the AT-OME-MH21. The **System** section provides controls for resetting the AT-OME-MH21 to factory-default settings and updating the firmware.

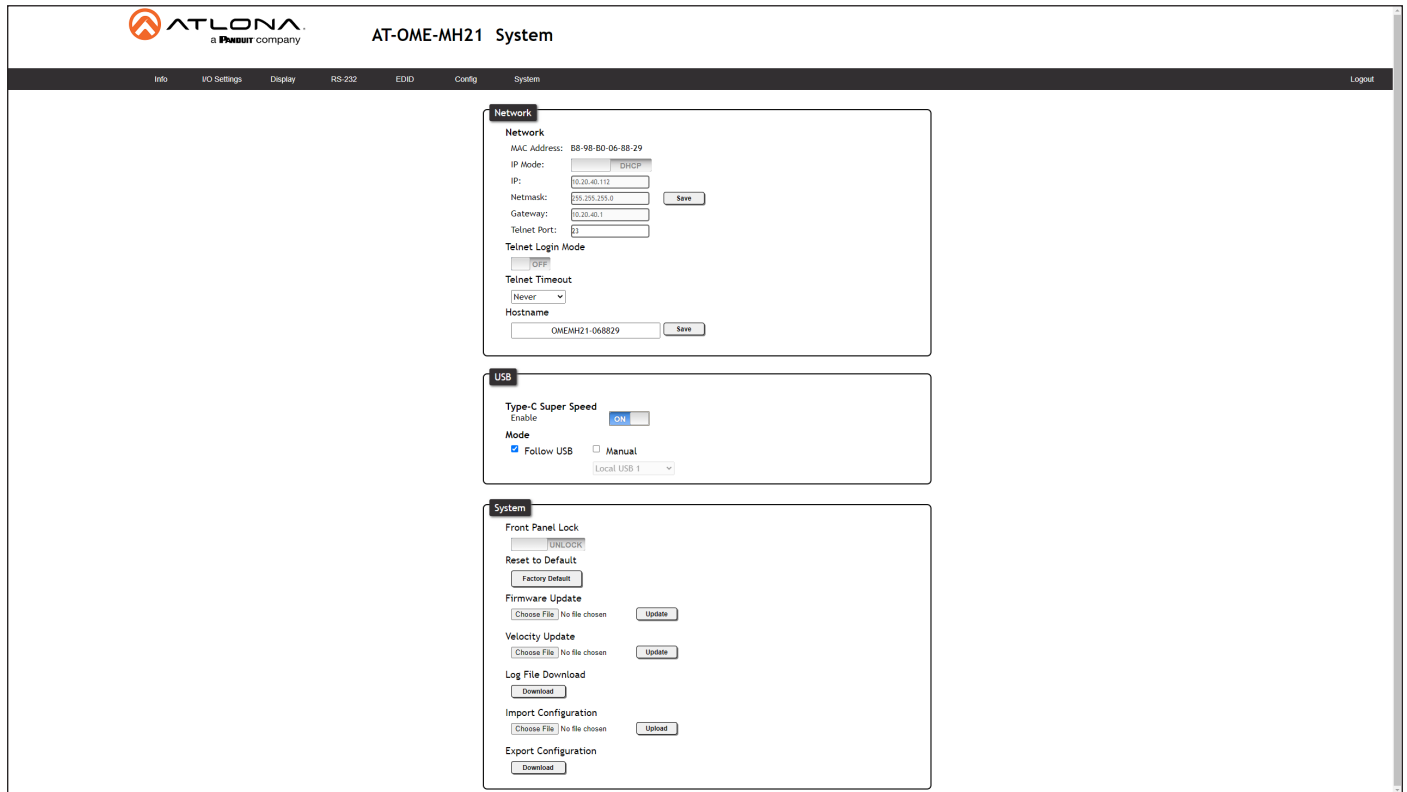

MAC Address

This field displays the MAC address of the AT-OME-MH21.

IP Mode

Click this toggle switch to set the AT-OME-MH21 to **DHCP** or **STATIC IP** mode. The default setting is **DHCP** mode.

IP

Enter the IP address of the AT-OME-MH21 in this field. This field will only be available when **IP Mode** is set to **STATIC IP**. The default static IP address of the AT-OME-MH21 is 192.168.1.254.

Netmask

Enter the subnet mask of the AT-OME-MH21 in this field. This field will only be available when **IP Mode** is set to **STATIC IP**.

Gateway

Enter the gateway (router) IP address in this field. This field will only be available when **IP Mode** is set to **STATIC IP**.

Telnet Port

Enter the desired Telnet port (for Telnet sessions) in this field. The default port is 23. Refer to [Changing the Telnet Port \(page 36\)](#) for more information.

Telnet Login Mode

Click this toggle switch to set the Telnet Login Mode to **ON** or **OFF**. If set to **ON**, then login credentials (same as web server) will be required when starting a Telnet session.

Configuration and Management Interfaces

Telnet Timeout

Click this drop-down list to select the timeout interval, in seconds. Range is: 10 to 3600 seconds, or Never. Refer to [Adjusting Telnet Timeout \(page 37\)](#) for more information.

Hostname

Displays the hostname of the AT-OME-MH21, as it would appear on a network. To change the hostname, type the new hostname in this field and click the **Save** button. Refer to [Setting the Host Name \(page 38\)](#) for more information.

Type-C Super Speed

Click the **Enable** toggle switch to the **ON** position to enable USB SS (Super Speed) mode on the USB-C input. Enabling USB SS mode provides data rates up to 5 Gbit/s (625 MB/s), allowing a maximum resolution of 4096x2048 @ 30 Hz RGB. If this feature is *disabled*, resolutions up to 4096x2048 are supported, but the data transfer rate will be reduced to 480 Mb/s (USB 2.0). USB SS mode is enabled by default.

Mode

Selects the desired USB switching mode. Refer to [USB Modes \(page 44\)](#) for more information.

EDID listing	Description
Follow USB	If both USB host ports are connected to host devices, then the AT-OME-MH21 will set the last-connected USB host device as the “active” USB host.
Manual	This mode provides manual selection of the USB host port to be used. When this mode is selected, select either Local Type-C or Local USB 1 from the drop-down list.

Front Panel Lock

Click this toggle switch to **LOCK** or **UNLOCK** the AT-OME-MH21. Refer to [Locking / Unlocking the Front Panel \(page 39\)](#) for more information.

Reset to Default

Click the **Factory Default** button to reset the AT-OME-MH21 to factory-default settings. Refer to [Resetting to Factory-Default Settings \(page 40\)](#) for more information.

Firmware Update

Click the **Choose File** button to begin the firmware update procedure. Refer to [Updating the Firmware \(page 59\)](#) for more information.

Velocity Update

Click the **Choose File** button to upgrade the Velocity database in the AT-OME-MH21.

Log File Download

Click the **Download** button to download the system event log file to the connected PC.

Import Configuration

Click the **Choose File** button to select a configuration file to restore. Click the **Upload** button to upload the configuration file to the AT-OME-MH21. Restoring a configuration file will erase the current unit configuration.

Export Configuration

Click the **Download** button to save the current system configuration to a local file.

Appendix

Updating the Firmware

Updating the firmware is performed using the built-in web server.

Requirements:

- AT-OME-MH21
 - Firmware file
 - Computer on the same network as the AT-OME-MH21
1. Download the firmware file from atlona.com and extract the contents of the .zip file to a folder on the computer desktop.
 2. Power on the unit and connect an Ethernet cable from the computer, containing the firmware, to the same network where the AT-OME-MH21 is connected.
 3. Login to the web server. Refer to [Web Server \(page 20\)](#) for more information.
 4. Click **System** in the menu bar.

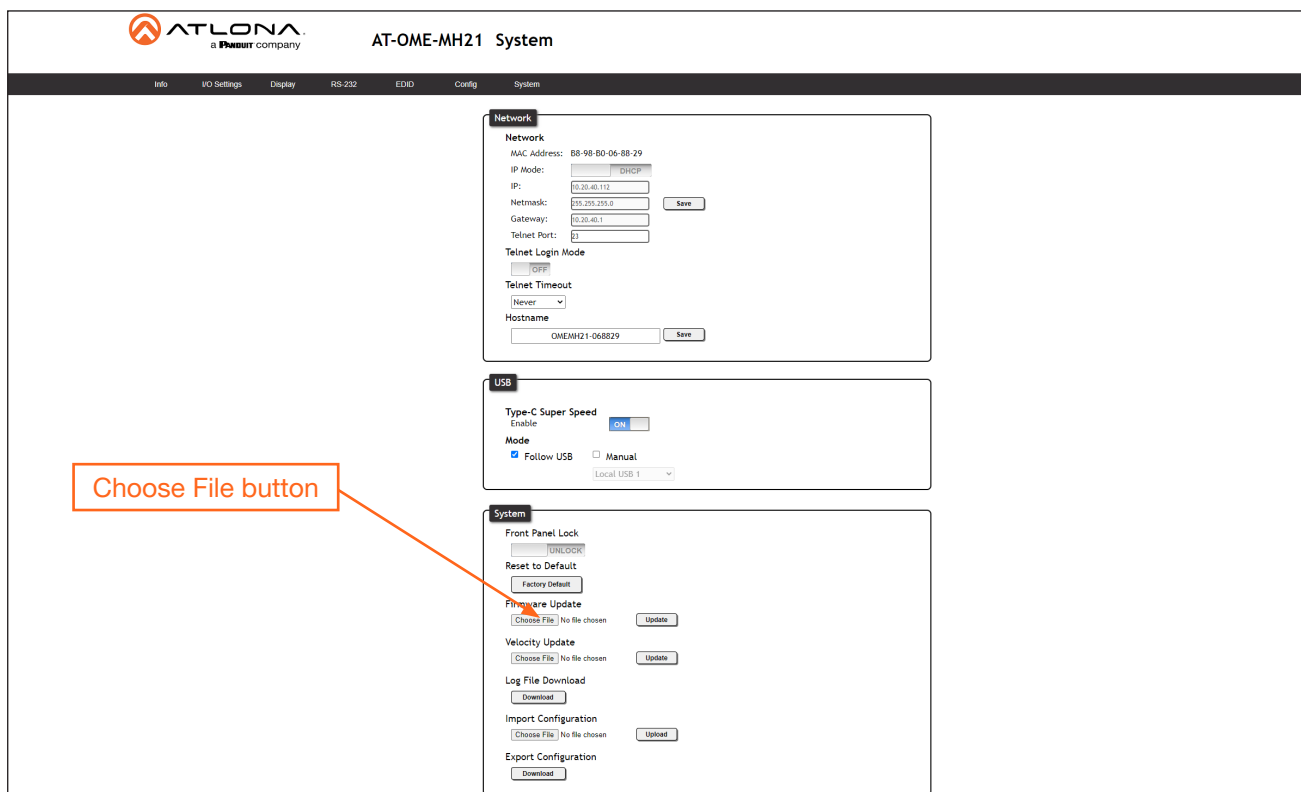

5. Click the **Choose File** button, under the **Firmware Update** section.

6. Browse to the location of the firmware file, select it, and click the **Open** button. Click the **Update** button, under the **Firmware Update** section. The following message box will be displayed.

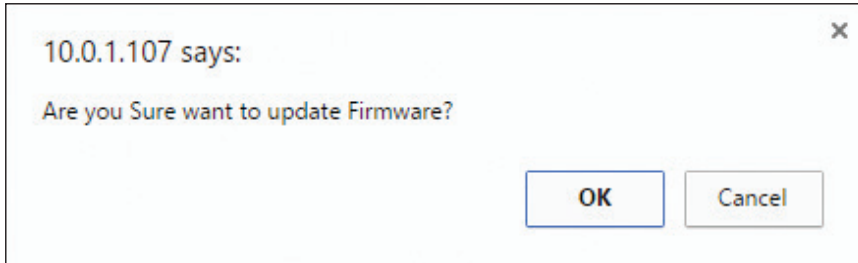

7. Click the **OK** button to begin the firmware update process. Click the **Cancel** button to cancel the process.
8. After the firmware update process is complete, the **Login** screen will be displayed.

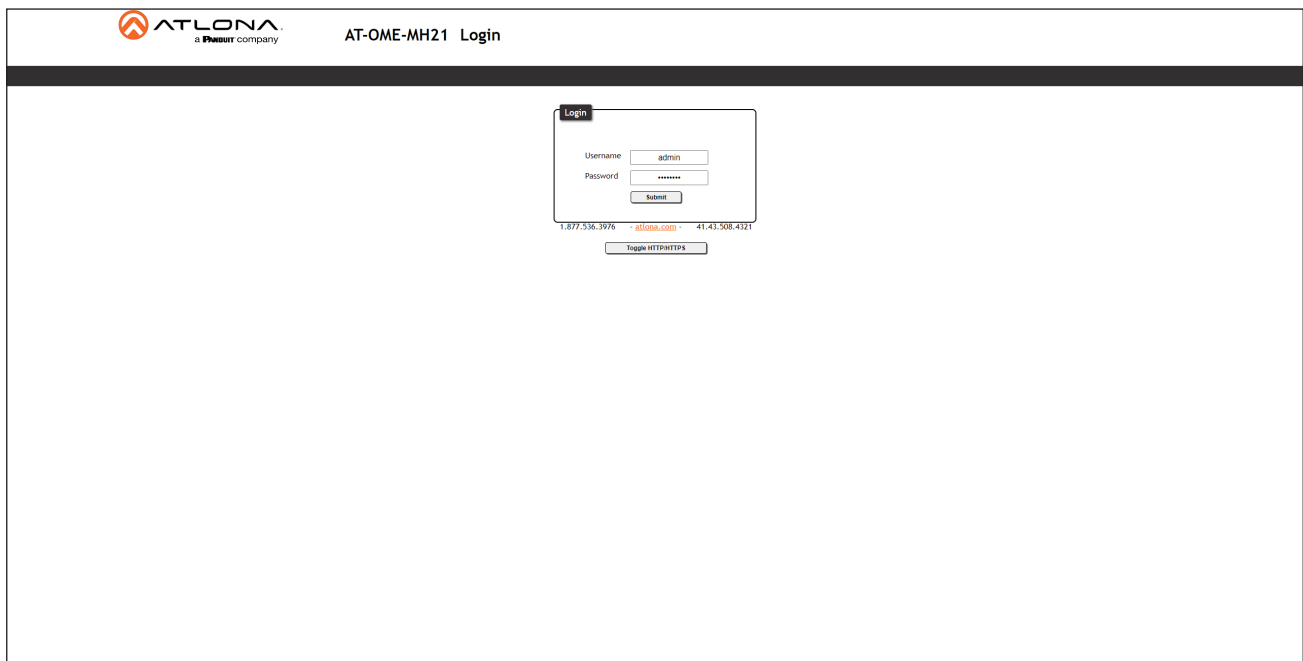

Mounting Instructions

The AT-OME-MH21 includes two mounting brackets, which can be used to attach the unit to any flat surface. Use the two enclosure screws, on the sides of the unit to attach the mounting brackets.

1. Using a small Phillips screwdriver, remove the two screws from the left side of the enclosure.

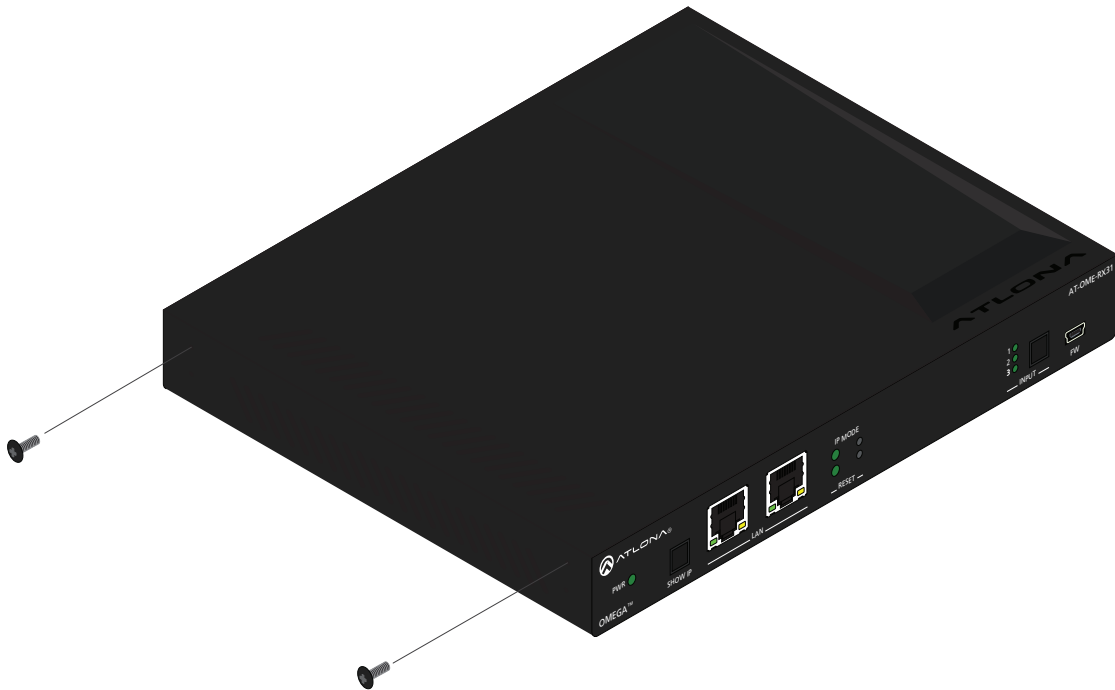

2. Position one of the mounting brackets, as shown below, aligning the holes on the side of the enclosure with one set of holes on the mounting bracket.
3. Use the screws from Step 1 to attach the mounting bracket.



4. Repeat steps 1 and 2 to attach the second mounting bracket to the opposite side of the unit.
5. Mount the unit to a flat surface using the oval-shaped holes, on each mounting bracket. If using a drywall surface, a #6 drywall screw is recommended.



NOTE: Mounting brackets can also be inverted to mount the unit under a table or other flat surface.

Specifications

Video		
Signal	HDMI	
Copy Protection	HDCP 2.2	
Pixel Clock	600 MHz	
UHD/HD/SD	4096×2160@60/50/30/25/24 Hz 3840×2160@60/50/30/25/24 Hz 1920×1080p@60/59.9/50/30/ 29.97/25/24/23.98 Hz 1920×1080i@30/29.97/25 Hz 1280×720p@60/59.94/50 Hz	720x576p@50 Hz 720x576i@50 Hz 640x480p@60/59.96 Hz 640x480i@30 Hz
VESA All resolutions are 60Hz	2560×1600 2048×1536 1920×1200 1680×1050 1600×1200 1440×900 1400×1050 1280×1024	1280×800 1366×768 1360×768 1152×864 1024×768 800×600 640×480
Scaler ⁽¹⁾	IN 4K@24 Hz 4K@30 Hz 4K@60 Hz, 4:2:0	OUT 1080p@24 Hz 1080p@30 Hz 1080p@60 Hz (YUV/RGB, 4:4:4)
USB-C	Up to 4K/UHD @ 60 Hz	
Color Space	YUV, RGB	
Chroma Subsampling	4:4:4, 4:2:2, 4:2:0	
Color Depth	8-bit, 10-bit, 12-bit	
HDR	HDR10, Hybrid-Log Gamma (HLG), and Dolby® Vision™ @ 60 Hz	

Audio			
HDMI Pass-Through Formats	PCM 2.0 LPCM 5.1 LPCM 7.1	Dolby® Digital Dolby Digital Plus™ Dolby TrueHD	DTS® Digital Surround™ DTS-HD Master Audio™
Bit Rate	24 Mbits/s max		
Analog Audio			
Format	2-channel stereo		
Balanced Output	+4 dBu, nominal gain; +20 dBu headroom		
Frequency Response	20 Hz to 20 kHz, ±0.5 dB		
Impedance	150 Ω		
Stereo channel separation	> 90 dB		
THD + N	< 0.004% @ 20 Hz to 20 kHz		
SNR	> 94 dB @ 1 kHz, zero clipping @ 0 dBFS, unweighted		

USB	
Compliance	3.0
Maximum Data Rate	5 Gbps ⁽²⁾
USB-C	Supports audio, video, device and host data

Ethernet	
Port	1 x RJ45
Standards and Protocols	HTTPS, Telnet, mDNS
Speeds	10/100/1000 Mbps
Addressing	DHCP, Static – selectable through rear panel, IP & RS-232 commands, and built-in web server

RS-232	
Port	2 x 3-pin captive screw
Use	Device control and configuration
Baud Rates	2400, 4800, 9600, 19200, 38400, 57600, 115200
Data flow	Bidirectional

IR	
Use	Pass-through control
Frequency Range	30 kHz to 60 kHz

CEC	
Port	HDMI, Type A, 19-pin female
Triggering	Through IP, RS-232, and built-in web server

Resolution / Distance	4K/UHD - Feet / Meters		1080p - Feet / Meters	
HDMI IN/OUT	15	5	30	10
USB-C	10	3	10	3

Buttons and Indicators	
Buttons: DISPLAY, INPUT IP MODE, RESET	2 – momentary, tact-type 2 – momentary, tact-type
Indicators: PWR, INPUT IP MODE, RESET	3 – LED, green 2 – LED, green

Connectors	
HDMI IN	1 – Type A, 19-pin female
USB-C IN	1 – USB Type-C v3.1, 24-pin female, AV input (Alternate Mode)
HDMI OUT	1 – Type A, 19-pin female
USB HUB	2 – Type A, 4-pin female
USB HOST	1 – Type B, female
AUDIO OUT	1 – 5-pin captive screw, balanced / unbalanced 2-channel
RS-232 / IR OUT	1 – 4-pin captive screw (bidirectional)
LAN	1 – RJ45, 100Base-T
PWR	1 - Barrel connector, locking

Environmental	Fahrenheit	Celsius
Operating Temperature	+32 to +122	0 to +50
Storage Temperature	-4 to +140	-20 to +60
Operating Humidity (RH)	20% to 90%, non-condensing	
Maximum Operating Altitude	2000 meters	

Power	
Consumption	Max: 14.5 W
External Power Supply	100 - 240 V AC, 50/60 Hz Output: 5 V / 4 A DC

Dimensions (H x W x D)	Inches	Millimeters
Unit	1.02 x 8.62 x 5.98	26 x 219 x 152
Power Supply (AT-PS-54-L)	1.22 x 1.97 x 3.17	31 x 50 x 80.6

Weight	Pounds	Kilograms
Device	2.15	0.975

Certification	
Device	CE, FCC
Power Supply	CE, FCC, UL

(1) Scaler does not support frame rate conversion.

(2) When USB SuperSpeed (SS) mode is enabled, video output is supported up to 4K @ 30 Hz and the USB data rate is 5 Gbps. If disabled, video output is supported up to 4K @ 60 Hz and data rate is limited to 480 Mbps.