

4-Post 1U Universal Adjustable Mounting Depth Rack Rail

Product Diagram (UNIRAILS1UB)

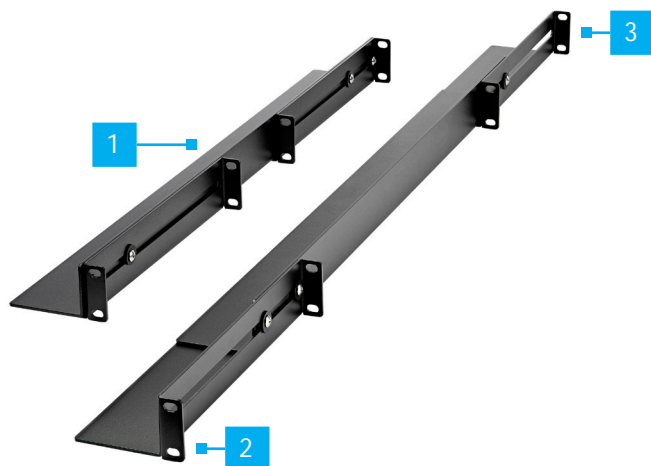

Component	Function
1 Adjustable Depth Basic 1U Universal Server Rail	<ul style="list-style-type: none"> Used to securely mount equipment (1U in height) in a Server Rack. Maximum Weight Capacity = 200 lb. (91.7 kg)
2 Front Bracket	<ul style="list-style-type: none"> Used to secure the Server Rail to a Server Rack.
3 Back Bracket	<ul style="list-style-type: none"> Used to secure the Server Rail to a Server Rack.

Requirements

For the latest requirements, please visit www.startech.com/UNIRAILS1UB

- Cage Nut Tool x 1 (Optional)
- Phillips Head Screwdriver x 1

Package Contents

- Adjustable Depth Basic 1U Universal Server Rail x 2
- M6-12 Screws x 8
- Cage Nuts x 8
- M6 Plastic Cap Washers x 8
- Quick-Start Guide x 1

Installing the Server Rail

1. Insert the **Cage Nuts** x 4 into the **Cage Nut Holes** on the front and back **Rails** of the **Server Rack**.

Note: You can use a **Cage Nut Tool** to aid in the installation of the **Cage Nuts**.

2. Align the **Screw Hole** on the **Back Bracket** on the **Server Rail** with the **Cage Nuts** (inserted in step 1) on the back **Rail** on the **Server Rack**.
3. Slide an **M6 Plastic Cap Washer** over-top of the **M6-12 Screw**.
4. Insert an **M6-12 Screw** through the **Server Rail Screw Hole** and into the **Cage Nut**.
5. Insert a second **M6-12 Screw** through the bottom **Washer** and **Server Rail Screw Hole** and into the **Cage Nut**.
6. Using a **Phillips Head Screwdriver** tighten the **M6-12 Screws**, being careful not to over-tighten.
7. Align the **Screw Hole** on the **Front Bracket** on the **Server Rail** with the **Cage Nuts** (inserted in step 1) on the front **Rail** on the **Server Rack**.
8. Slide an **M6 Plastic Cap Washer** over-top of the **M6-12 Screw**.
9. Insert an **M6-12 Screw** through the **Server Rail Screw Hole** and into the **Cage Nut**.
10. Insert a second **M6-12 Screw** through the bottom **Washer** and **Server Rail Screw Hole** and into the **Cage Nut**.
11. Using a **Phillips Head Screwdriver** tighten the **M6-12 Screws**, being careful not to over-tighten.
12. Repeat Steps 1 - 11 to install the second **Server Rail**.

Product Size

Position	Measurement
Closed	610 mm (24")
Extended	914 mm (36")

Use of Trademarks, Registered Trademarks, and other Protected Names and Symbols

This manual may make reference to trademarks, registered trademarks, and other protected names and/or symbols of third-party companies not related in any way to StarTech.com. Where they occur these references are for illustrative purposes only and do not represent an endorsement of a product or service by StarTech.com, or an endorsement of the product(s) to which this manual applies by the third-party company in question. StarTech.com hereby acknowledges that all trademarks, registered trademarks, service marks, and other protected names and/or symbols contained in this manual and related documents are the property of their respective holders.

Warranty Information

This product is backed by a lifetime warranty.

For further information on product warranty terms and conditions, please refer to www.startech.com/warranty.

Limitation of Liability

In no event shall the liability of StarTech.com Ltd. and StarTech.com USA LLP (or their officers, directors, employees or agents) for any damages (whether direct or indirect, special, punitive, incidental, consequential, or otherwise), loss of profits, loss of business, or any pecuniary loss, arising out of or related to the use of the product exceed the actual price paid for the product. Some states do not allow the exclusion or limitation of incidental or consequential damages. If such laws apply, the limitations or exclusions contained in this statement may not apply to you.

StarTech.com Ltd. 45 Artisans Cres London, Ontario N5V 5E9 Canada	StarTech.com LLP 2500 Creekside Parkwy Lockbourne, Ohio 43137 U.S.A.	StarTech.com Ltd. Unit B, Pinnacle 15 Gowerton Rd, Brackmills Northampton NN4 7BW United Kingdom	FR: startech.com/fr DE: startech.com/de ES: startech.com/es NL: startech.com/nl IT: startech.com/it JP: startech.com/jp
--	--	---	--