



IDEAL FOR MOUNTING TO ANGLED CEILINGS

BT893-FD

FIXED DROP PROJECTOR CEILING MOUNT WITH MICRO-ADJUSTMENT

The BT893-FD is a ceiling mounted, universal projector mount designed to mount projectors up to 70kg. Suitable for use with angled ceilings, the BT893-FD features easy adjustment of tilt, yaw & roll plus additional micro-adjustment at each corner makes alignment of projections quick & simple. The projector fits to a mounting plate that can be extended to accommodate large ceiling patterns using the included extension legs. Available in a range of pole lengths to suit your requirements.

SPECIFICATION

Max load	70kg
Tilt	+20°/-10° (+/-5° with micro-adjustment)
Yaw	45°
Roll	+/-5°
Ceiling plate tilt	90°
Max distance between fixings	873mm
Max distance (square fixing pattern)	618mm
Colour option	Black or Chrome pole

FEATURES

- Designed to mount heavy duty projectors from the ceiling
- Adjustable ceiling plate suitable for angled ceilings
- Easy, incremented tilt adjustment
- Micro-adjustment thumbwheels at 4-points for controlled & precise adjustment of the projector
- Ideal for use with projection mapping projectors
- Pole is internally unobstructed for cables to pass through easily
- Optional extension legs can be used to accommodate larger ceiling patterns
- Suitable for projectors using M6, M8, M10 & M12 fixings
- Quick & easy assembly
- All mounting hardware included

AVAILABLE IN 6 POLE LENGTHS

BT893-FD025	0.25m Pole	BT893-FD150	1.5m Pole
BT893-FD050	0.5m Pole	BT893-FD200	2m Pole
BT893-FD100	1m Pole	BT893-FD300	3m Pole

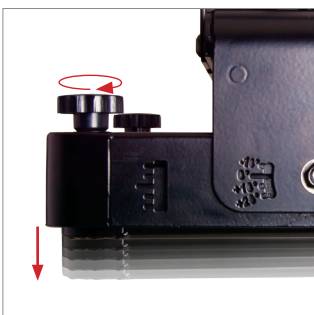

Micro-adjustment thumbwheels at 4-points for controlled & precise adjustment of the projector



Ceiling plate can be mounted onto a ceiling with angles up to 90°



Features easy, incremented tilt adjustment



BT893-FD Projector Mount features an adjustable drop that allows users to easily adjust the height of the mount

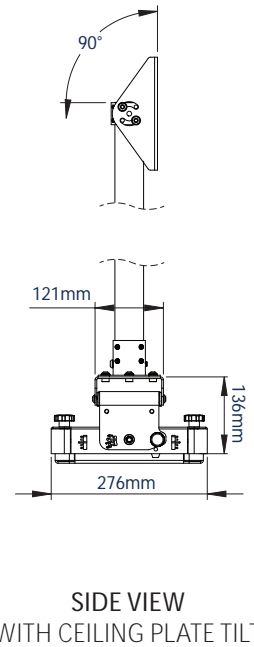
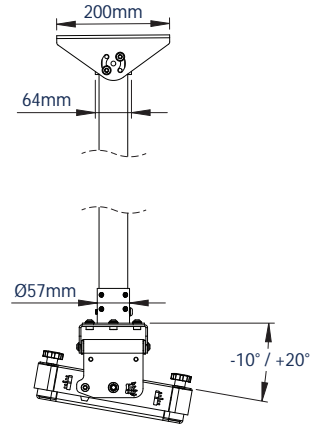
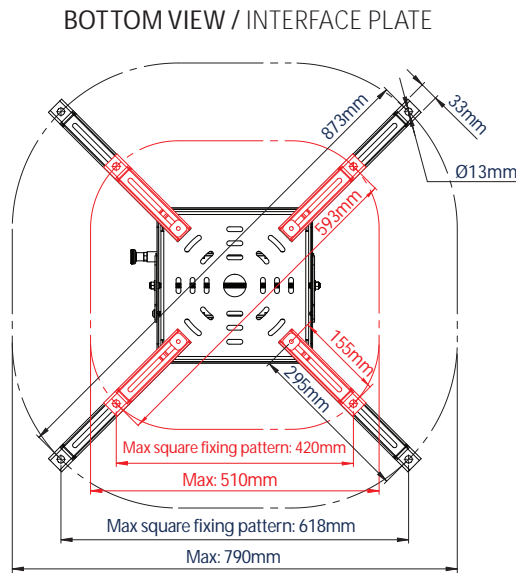
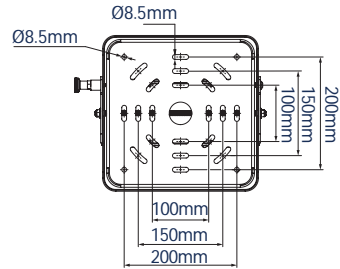
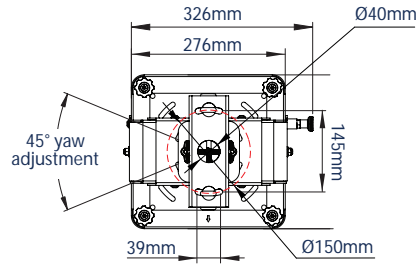
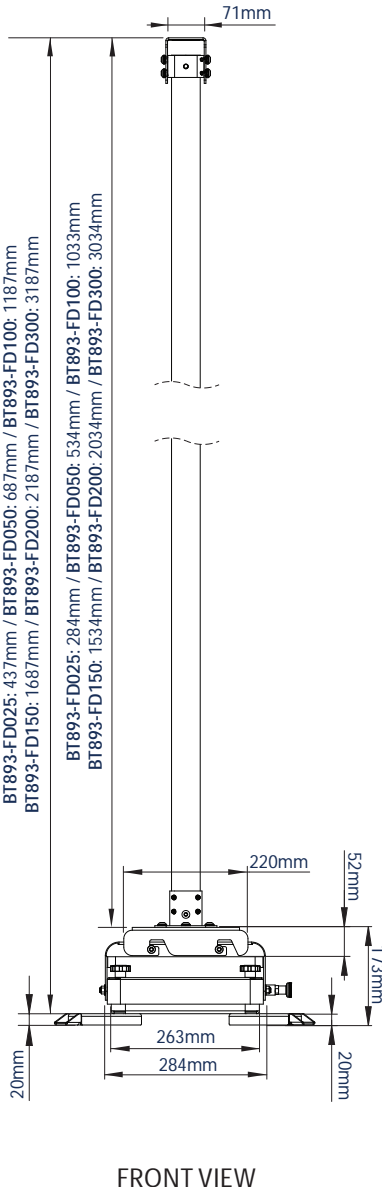

PACKING INFORMATION

ORIGINAL DESIGNS BY B-TECH AV MOUNTS - REGISTERED DESIGNS & PATENTS APPLY

ORDER REF:	LENGTH:	COLOUR:	EAN CODE:	MC QTY:	IC QTY:	MC WEIGHT:	MC CUBE:
BT893-FD025/BB	0.25m Pole	Black with Black pole	5019318759840	1 / 1	0 / 0	8kg / 0.50kg	0.00154cbm / 0.001cbm
BT893-FD025/BC	0.25m Pole	Black with Chrome pole	5019318759857	1 / 1	0 / 0	8kg / 0.50kg	0.00154cbm / 0.001cbm
BT893-FD050/BB	0.5m Pole	Black with Black pole	5019318759864	1 / 1	0 / 0	8kg / 0.98kg	0.00154cbm / 0.001cbm
BT893-FD050/BC	0.5m Pole	Black with Chrome pole	5019318759871	1 / 1	0 / 0	8kg / 0.98kg	0.00154cbm / 0.001cbm
BT893-FD100/BB	1m Pole	Black with Black pole	5019318759888	1 / 1	0 / 0	8kg / 1.93kg	0.00154cbm / 0.003cbm
BT893-FD100/BC	1m Pole	Black with Chrome pole	5019318759895	1 / 1	0 / 0	8kg / 1.93kg	0.00154cbm / 0.003cbm
BT893-FD150/BB	1.5m Pole	Black with Black pole	5019318759901	1 / 1	0 / 0	8kg / 3.09kg	0.00154cbm / 0.005cbm
BT893-FD150/BC	1.5m Pole	Black with Chrome pole	5019318759918	1 / 1	0 / 0	8kg / 3.09kg	0.00154cbm / 0.005cbm
BT893-FD200/BB	2m Pole	Black with Black pole	5019318759925	1 / 1	0 / 0	8kg / 3.83kg	0.00154cbm / 0.007cbm
BT893-FD200/BC	2m Pole	Black with Chrome pole	5019318759932	1 / 1	0 / 0	8kg / 3.83kg	0.00154cbm / 0.007cbm
BT893-FD300/BB	3m Pole	Black with Black pole	5019318759949	1 / 1	0 / 0	8kg / 5.79kg	0.00154cbm / 0.010cbm
BT893-FD300/BC	3m Pole	Black with Chrome pole	5019318759956	1 / 1	0 / 0	8kg / 5.79kg	0.00154cbm / 0.010cbm

© 2018 B-Tech AV Mounts. B-Tech AV Mounts Ltd. All rights reserved.
 The information on this page is for general reference only. It does not constitute an offer of any product or service. B-Tech AV Mounts Ltd. is not responsible for any damage or loss of data caused by the use of its products. Any reproduction or dissemination of any part of this page, in whole or in part, without the prior written permission of B-Tech AV Mounts Ltd. is strictly prohibited.
 SS-V1-BT893-FD-060718