



IDEAL FOR MOUNTING TO ANGLED CEILINGS

# BT893-FD

## FIXED DROP PROJECTOR CEILING MOUNT WITH MICRO-ADJUSTMENT

The BT893-FD is a ceiling mounted, universal projector mount designed to mount projectors up to 70kg. Suitable for use with angled ceilings, the BT893-FD features easy adjustment of tilt, yaw & roll plus additional micro-adjustment at each corner makes alignment of projections quick & simple. The projector fits to a mounting plate that can be extended to accommodate large ceiling patterns using the included extension legs. Available in a range of pole lengths to suit your requirements.

### SPECIFICATION

Max load	70kg
Tilt	+20°/-10° (+/-5° with micro-adjustment)
Yaw	45°
Roll	+/-5°
Ceiling plate tilt	90°
Max distance between fixings	873mm
Max distance (square ceiling pattern)	618mm
Colour option	Black or Chrome pole

### FEATURES

- Designed to mount heavy duty projectors from the ceiling
- Adjustable ceiling plate suitable for angled ceilings
- Easy, incremented tilt adjustment
- Micro-adjustment thumbwheels at 4-points for controlled & precise adjustment of the projector
- Ideal for use with projection mapping projectors
- Pole is internally unobstructed for cables to pass through easily
- Optional extension legs can be used to accommodate larger ceiling patterns
- Suitable for projectors using M6, M8, M10 & M12 fixings
- Quick & easy assembly
- All mounting hardware included



### AVAILABLE IN 6 POLE LENGTHS

BT893-FD025	0.25m Pole	BT893-FD150	1.5m Pole
BT893-FD050	0.5m Pole	BT893-FD200	2m Pole
BT893-FD100	1m Pole	BT893-FD300	3m Pole



POLE

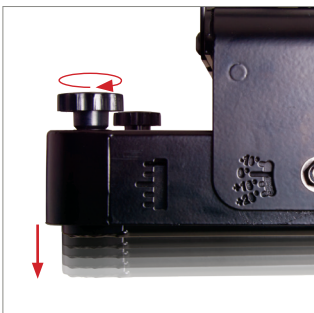

Micro-adjustment thumbwheels at 4-points for controlled & precise adjustment of the projector



Ceiling plate can be mounted onto a ceiling with angles up to 90°



Features easy, incremented tilt adjustment



ALSO AVAILABLE...

BT893-FD Projector Mount features an adjustable drop that allows users to easily adjust the height of the mount

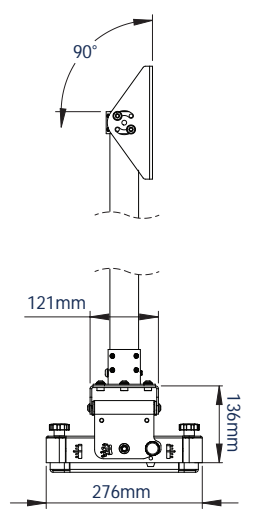
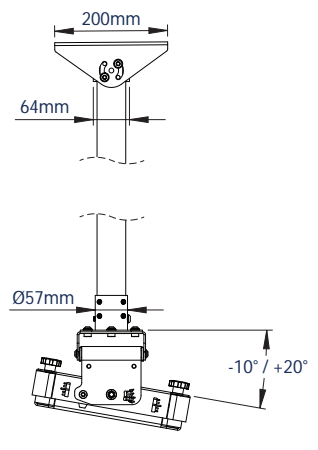
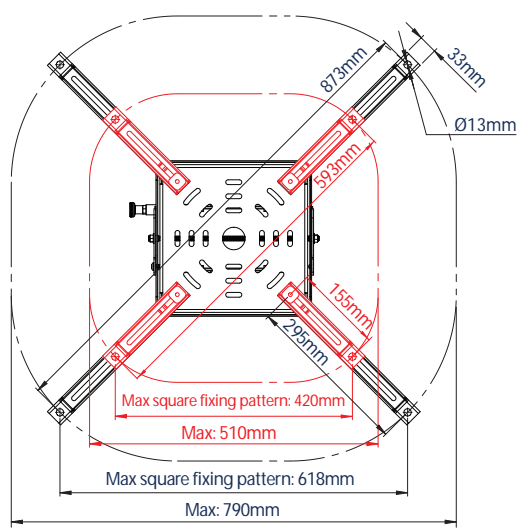
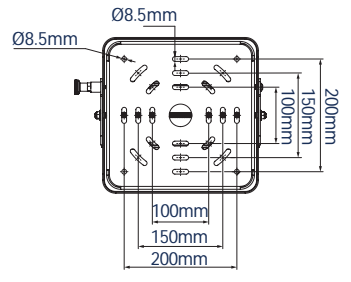
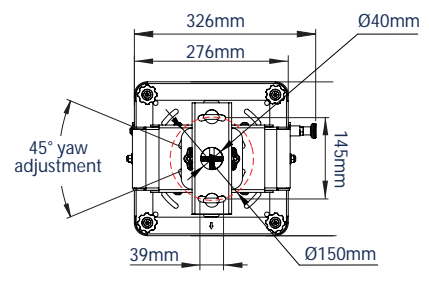
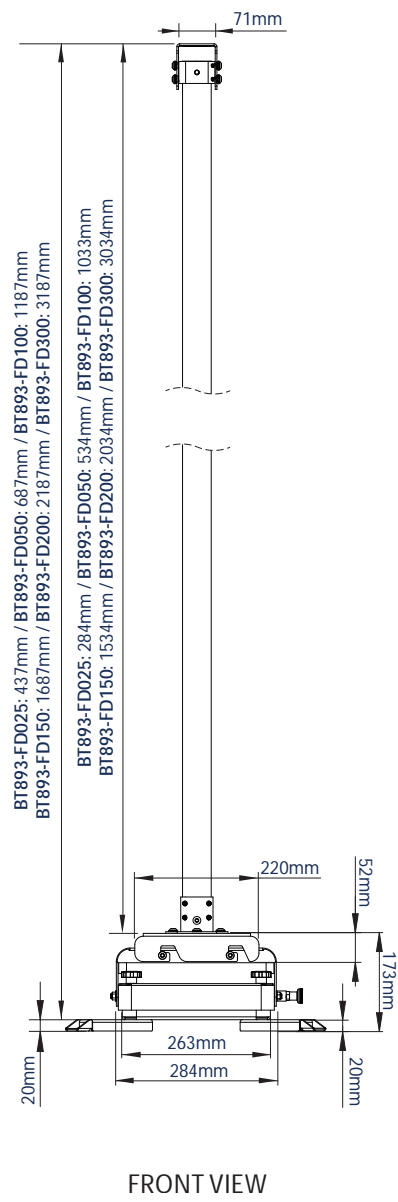

**PACKING INFORMATION**

ORDER REF:	LENGTH:	COLOR:	EAN CODE:	MC QTY:	IC QTY:	MC WEIGHT:	MC CUBE:
BT893-FD025/BB	0.25m Pole	Black with Black pole	5019318759840	1 / 1	0 / 0	8kg / 0.50kg	0.00154cbm / 0.001cbm
BT893-FD025/BC	0.25m Pole	Black with Chrome pole	5019318759857	1 / 1	0 / 0	8kg / 0.50kg	0.00154cbm / 0.001cbm
BT893-FD050/BB	0.5m Pole	Black with Black pole	5019318759864	1 / 1	0 / 0	8kg / 0.98kg	0.00154cbm / 0.001cbm
BT893-FD050/BC	0.5m Pole	Black with Chrome pole	5019318759871	1 / 1	0 / 0	8kg / 0.98kg	0.00154cbm / 0.001cbm
BT893-FD100/BB	1m Pole	Black with Black pole	5019318759888	1 / 1	0 / 0	8kg / 1.93kg	0.00154cbm / 0.003cbm
BT893-FD100/BC	1m Pole	Black with Chrome pole	5019318759895	1 / 1	0 / 0	8kg / 1.93kg	0.00154cbm / 0.003cbm
BT893-FD150/BB	1.5m Pole	Black with Black pole	5019318759901	1 / 1	0 / 0	8kg / 3.09kg	0.00154cbm / 0.005cbm
BT893-FD150/BC	1.5m Pole	Black with Chrome pole	5019318759918	1 / 1	0 / 0	8kg / 3.09kg	0.00154cbm / 0.005cbm
BT893-FD200/BB	2m Pole	Black with Black pole	5019318759925	1 / 1	0 / 0	8kg / 3.83kg	0.00154cbm / 0.007cbm
BT893-FD200/BC	2m Pole	Black with Chrome pole	5019318759932	1 / 1	0 / 0	8kg / 3.83kg	0.00154cbm / 0.007cbm
BT893-FD300/BB	3m Pole	Black with Black pole	5019318759949	1 / 1	0 / 0	8kg / 5.79kg	0.00154cbm / 0.010cbm
BT893-FD300/BC	3m Pole	Black with Chrome pole	5019318759956	1 / 1	0 / 0	8kg / 5.79kg	0.00154cbm / 0.010cbm

**ORIGINAL DESIGNS BY B-TECH AV MOUNTS - REGISTERED DESIGNS & PATENTS APPLY**

© 2015 B-Tech Av Mounts. All rights reserved. The information in this specification is subject to change without notice. This document and its contents are trademarks of B-Tech Av Mounts Design & Manufacturing Ltd. No responsibility is accepted for loss or damage caused by improper installation or use. Any reproduction or reuse of any part of this specification without the written permission of B-Tech Av Mounts Design & Manufacturing Ltd. is prohibited.

SS-V1-BT893-FD-060718