

# GS980M Series

Gigabit Ethernet Switches  
AlliedWare Plus™

AT-GS980M/52

AT-GS980M/52PS

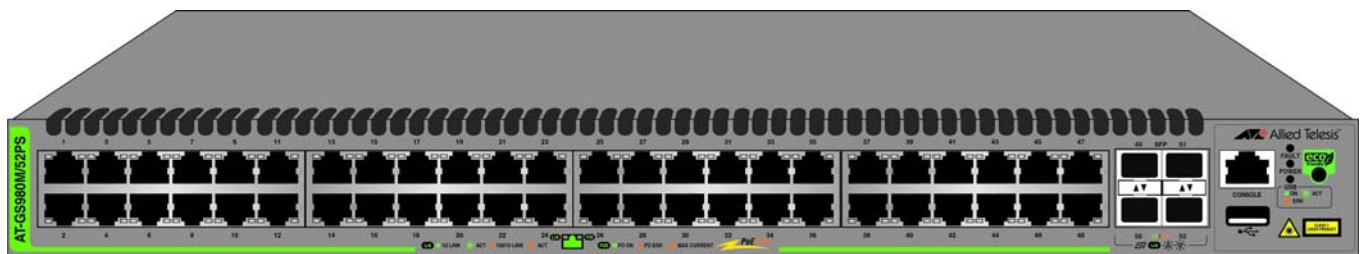
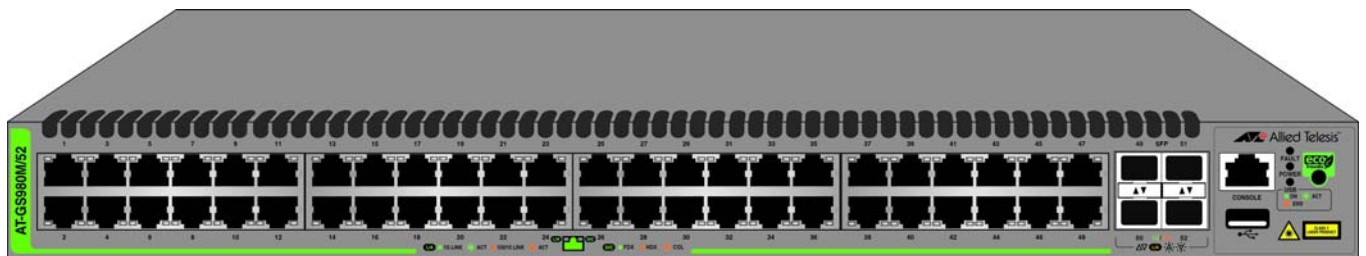

## Installation Guide

Copyright © 2019 Allied Telesis, Inc.

All rights reserved. No part of this publication may be reproduced without prior written permission from Allied Telesis, Inc.

Allied Telesis, VCStack, and the Allied Telesis logo are trademarks of Allied Telesis, Incorporated. All other product names, company names, logos or other designations mentioned herein are trademarks or registered trademarks of their respective owners.

Allied Telesis, Inc. reserves the right to make changes in specifications and other information contained in this document without prior written notice. The information provided herein is subject to change without notice. In no event shall Allied Telesis, Inc. be liable for any incidental, special, indirect, or consequential damages whatsoever, including but not limited to lost profits, arising out of or related to this manual or the information contained herein, even if Allied Telesis, Inc. has been advised of, known, or should have known, the possibility of such damages.

# Electrical Safety and Emissions Standards

---

This product meets the following standards.

U.S. Federal Communications Commission
<p><b>Radiated Energy</b></p> <p>Note: This equipment has been tested and found to comply with the limits for a Class A digital device pursuant to Part 15 of FCC Rules. These limits are designed to provide reasonable protection against harmful interference when the equipment is operated in a commercial environment. This equipment generates, uses, and can radiate radio frequency energy and, if not installed and used in accordance with this instruction manual, may cause harmful interference to radio communications. Operation of this equipment in a residential area is likely to cause harmful interference in which case the user will be required to correct the interference at his own expense.</p> <p>Note: Modifications or changes not expressly approved of by the manufacturer or the FCC, can void your right to operate this equipment.</p>

Industry Canada
<p>This Class A digital apparatus complies with Canadian ICES-003.</p> <p>Cet appareil numérique de la classe A est conforme à la norme NMB-003 du Canada.</p>

**Warning:** In a domestic environment this product may cause radio interference in which case the user may be required to take adequate measures.

EMC	EN 55024 EN 55032 Class A EN 61000-3-2 EN 61000-3-3 FCC Part 15 (CFR 47) Class A VCCI Class A CISPR 22 Class A ICES-003
Environmental Compliance	RoHS WEEE
Electrical Safety	EN 60950-1 (second edition) CAN/CSA-C22.2 No. 60950-1-07 (second edition) UL 60950-1 (second edition) cULus Mark TUV-T-Mark
Regulatory Compliance	RCM CE



Laser Safety

EN60825

## Translated Safety Statements

---

**Important:** Safety statements that have the  symbol are translated into multiple languages in the *Translated Safety Statements* document at [www.alliedtelesis.com/library](http://www.alliedtelesis.com/library).

**Remarque:** Les consignes de sécurité portant le symbole  sont traduites dans plusieurs langues dans le document *Translated Safety Statements*, disponible à l'adresse [www.alliedtelesis.com/library](http://www.alliedtelesis.com/library)

# Contents

---

<b>Preface</b> .....	11
Document Conventions .....	12
Contacting Allied Telesis .....	13
<b>Chapter 1: Overview</b> .....	15
Front and Rear Panels .....	16
Management Panel .....	18
Features .....	19
GS980M Models.....	19
10/100/1000Mbps Twisted Pair Ports .....	19
100Mbps or 1Gbps SFP Transceiver Ports.....	19
Power Over Ethernet.....	20
LEDs.....	20
Installation Options .....	20
Management Software and Interfaces .....	20
Console Port.....	20
USB Port .....	21
Management Methods.....	21
Power Conservation .....	21
MAC Address Table .....	21
10/100/1000Mbps Twisted Pair Ports.....	22
Connector Type.....	22
Speed.....	22
Duplex Mode .....	22
Maximum Distance .....	22
Cable Requirements.....	22
Automatic MDIX Detection .....	23
LEDs.....	23
Power Over Ethernet on the AT-GS980M/52PS Switch.....	26
PoE Standards .....	26
Powered Device Classes .....	26
Power Budget.....	27
Port Priorities.....	27
Wiring Implementation.....	28
SFP Transceiver Ports.....	29
SFP Transceivers.....	29
LEDs.....	29
Fault and Power LEDs.....	31
eco-friendly Button.....	32
USB Port.....	33
USB Port LED .....	33
Console Port.....	34
Power Supply and Fan .....	35
Specifying Ports in the Command Line Interface.....	36
<b>Chapter 2: Beginning the Installation</b> .....	37
Reviewing Safety Precautions.....	38
Installation Options .....	42
Choosing a Site for the Switch .....	43
Unpacking the Switch .....	44

**Chapter 3: Installing the Switch on a Table or Desktop** ..... 47

**Chapter 4: Installing the Switch in an Equipment Rack** ..... 51

    Beginning the Installation..... 52

        Required Items ..... 52

        Switch Orientations in the Equipment Rack..... 52

    Removing the Bumper Feet..... 54

    Installing the Switch ..... 55

**Chapter 5: Installing the Switch on a Wall** ..... 57

    Switch Orientations on a Wall..... 58

    Installation Guidelines..... 59

        Tools and Material ..... 59

    Plywood Base ..... 61

        Installing a Plywood Base ..... 63

        Installing the Switch on a Plywood Base ..... 64

        Installing the Switch on a Concrete Wall..... 66

**Chapter 6: Cabling the Networking Ports and Powering On the Switch** ..... 69

    Cabling Twisted Pair Ports..... 70

    Guidelines to Handling SFP Transceivers ..... 71

    Installing SFP Transceivers ..... 72

    Powering On the Switch..... 76

    Starting a Local Management Session ..... 79

    Verifying the Switch with AlliedWare Plus Commands ..... 81

**Chapter 7: Troubleshooting** ..... 83

**Appendix A: Technical Specifications** ..... 87

    Physical Specifications ..... 88

    Environmental Specifications..... 89

    Power Specifications..... 90

    Certificates ..... 91

    RJ-45 Twisted Pair Port Pinouts ..... 92

    RJ-45 Style Serial Console Port Pinouts ..... 94

# Figures

---

Figure 1: Front Panels of the GS980M Series Switches .....	16
Figure 2: Back Panels .....	17
Figure 3: Management Panel .....	18
Figure 4: LEDs for the Twisted Pair Ports on the AT-GS980M/52 Switch.....	23
Figure 5: LEDs for the Twisted Pair Ports on the AT-GS980M/52PS Switch .....	24
Figure 6: SFP Transceiver Port LEDs .....	29
Figure 7: Fault and Power LEDs.....	31
Figure 8: eco-friendly Button .....	32
Figure 9: USB Port and LED .....	33
Figure 10: PORT Parameter in the Command Line Interface.....	36
Figure 11: Installation Options.....	42
Figure 12: GS980M Switch Shipping Box.....	44
Figure 13: Accessory Kit Items.....	45
Figure 14: Parts of the Bumper Feet .....	47
Figure 15: Inset the Rivet Housing into the Bumper Foot.....	48
Figure 16: Place the Bumper Foot on a Base Corner Hole .....	48
Figure 17: Inserting the Rivet into the Bumper Foot.....	49
Figure 18: Bracket Holes on the Switch.....	52
Figure 19: GS980M Switch Orientations in an Equipment Rack .....	53
Figure 20: Removing the Bumper Feet.....	54
Figure 21: Example of Attaching the Brackets to the Switch.....	55
Figure 22: Installing the Switch in an Equipment Rack.....	56
Figure 23: Positioning the Switch on a Wall .....	58
Figure 24: Switch on a Wall with a Plywood Base.....	61
Figure 25: Steps to Installing the Switch with a Plywood Base .....	62
Figure 26: Bracket Positions for Installing Switch on a Wall.....	64
Figure 27: Securing the Switch to the Plywood Base.....	65
Figure 28: Marking the Locations of the Bracket Holes on a Concrete Wall .....	67
Figure 29: Installing the Switch on a Concrete Wall .....	68
Figure 30: Removing the Dust Plug from an SFP Port.....	72
Figure 31: Installing an SFP Transceiver.....	73
Figure 32: Removing the Dust Cover from an SFP Transceiver .....	74
Figure 33: Positioning the SFP Handle in the Upright Position .....	74
Figure 34: Connecting a Fiber Optic Cable to an SFP Transceiver.....	75
Figure 35: Installing the Power Cord Retaining Clip.....	76
Figure 36: Connecting the AC Power Cord .....	77
Figure 37: Lowering the Power Cord Retaining Clip.....	77
Figure 38: Connecting the Power Cord to an AC Power Source.....	78
Figure 39: Connecting the Management Cable to the Console RS-232 Port.....	79
Figure 40: User Exec Mode Prompt .....	80
Figure 41: Pin Layout for the RJ-45 Twisted Pair Ports (Front View).....	92





# Tables

---

Table 1: Basic Features .....	19
Table 2: LEDS for the Twisted Pair Ports on the AT-GS980M/52 Switch .....	23
Table 3: LEDs for the Twisted Pair Ports on the AT-GS980M/52PS Switch .....	25
Table 4: IEEE Powered Device Classes .....	26
Table 5: LEDS for the SFP Transceiver Ports .....	29
Table 6: Fault and Power LEDS .....	31
Table 7: USB LED .....	33
Table 8: PORT Parameter Format .....	36
Table 9: Product Dimensions .....	88
Table 10: Product Weights .....	88
Table 11: Ventilation Requirements .....	88
Table 12: Environmental Specifications .....	89
Table 13: Maximum Power Consumptions .....	90
Table 14: Input Voltages .....	90
Table 15: Heat Dissipations .....	90
Table 16: Product Certificates .....	91
Table 17: Pin Signals on the RJ-45 Twisted Pair Ports at 10 or 100Mbps .....	92
Table 18: Pin Signals on the RJ-45 Twisted Pair Ports at 1Gbps .....	92
Table 19: Pin Signals of the RJ-45 Style Serial Console Port .....	94



# Preface

---

This guide contains the installation instructions for the GS980M Series of Gigabit Ethernet switches. This preface contains the following sections:

- “Document Conventions” on page 12
- “Contacting Allied Telesis” on page 13

## Document Conventions

---

This document uses the following conventions:

---

**Note**

Notes provide additional information.

---



---

**Caution**

Cautions inform you that performing or omitting a specific action may result in equipment damage or loss of data.

---



---

**Warning**

Warnings inform you that performing or omitting a specific action may result in bodily injury.

---

## Contacting Allied Telesis

---

If you need assistance with this product, you can contact Allied Telesis technical support by going to the Support & Services section of the Allied Telesis web site at **[www.alliedtelesis.com/support](http://www.alliedtelesis.com/support)**. You can find links for the following services on this page:

- ❑ 24/7 Online Support — Enter our interactive support center to search for answers to your product questions in our knowledge database, to check support tickets, to learn about RMAs, and to contact Allied Telesis technical experts.
- ❑ USA and EMEA phone support — Select the phone number that best fits your location and customer type.
- ❑ Hardware warranty information — Learn about Allied Telesis warranties and register your product online.
- ❑ Replacement Services — Submit a Return Merchandise Authorization (RMA) request via our interactive support center.
- ❑ Documentation — View the most recent installation and user guides, software release notes, white papers, and data sheets for your products.
- ❑ Software Downloads — Download the latest software releases for your managed products.

For sales or corporate information, go to **[www.alliedtelesis.com/contact](http://www.alliedtelesis.com/contact)** and select your region.



## Chapter 1

# Overview

---

This chapter contains the following sections:

- ❑ “Front and Rear Panels” on page 16
- ❑ “Management Panel” on page 18
- ❑ “Features” on page 19
- ❑ “10/100/1000Mbps Twisted Pair Ports” on page 22
- ❑ “Power Over Ethernet on the AT-GS980M/52PS Switch” on page 26
- ❑ “SFP Transceiver Ports” on page 29
- ❑ “Fault and Power LEDs” on page 31
- ❑ “eco-friendly Button” on page 32
- ❑ “USB Port” on page 33
- ❑ “Console Port” on page 34
- ❑ “Power Supply and Fan” on page 35
- ❑ “Specifying Ports in the Command Line Interface” on page 36

## Front and Rear Panels

The front panels of the GS980M Gigabit Ethernet Switches are shown in Figure 1.

### AT-GS980M/52 Switch

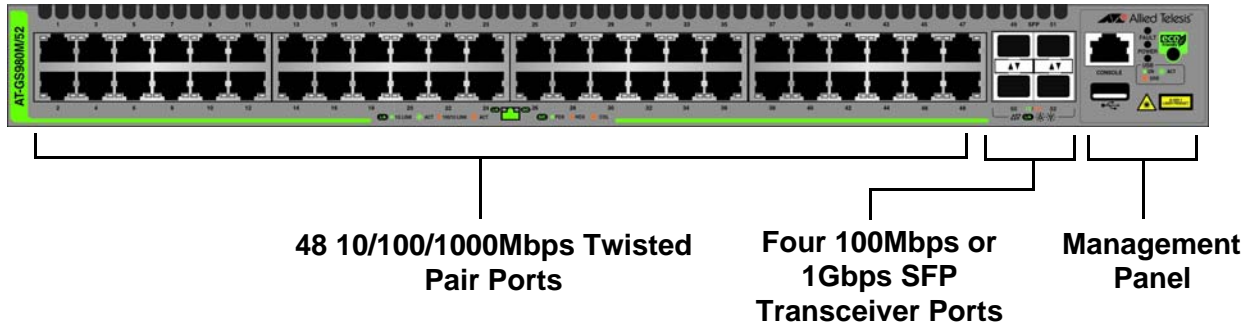

### AT-GS980M/52PS Switch

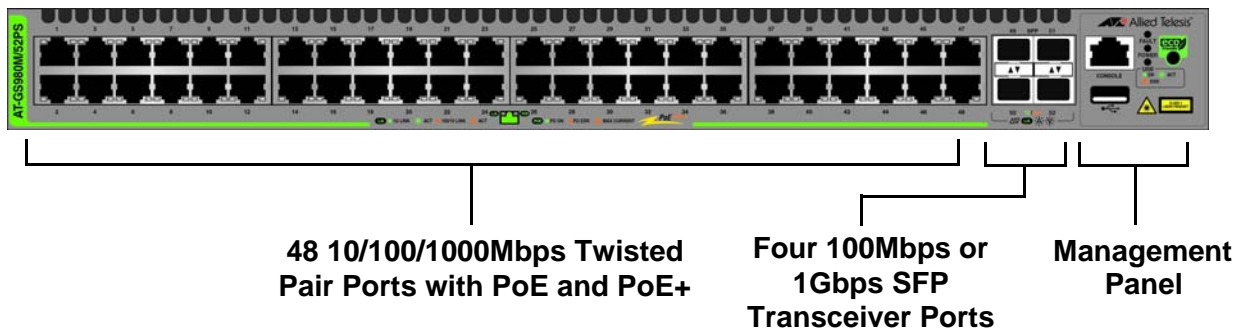
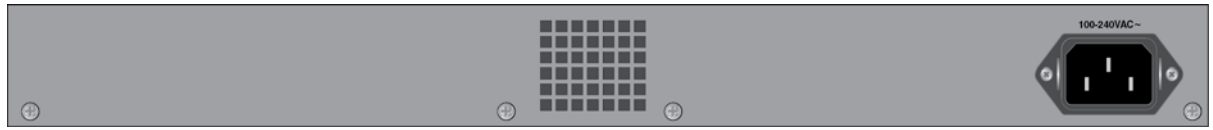

Figure 1. Front Panels of the GS980M Series Switches

The rear panels are shown in Figure 2 on page 17.



**AT-GS980M/52 Switch**



|  
**AC Power  
Supply Connector**

**AT-GS980M/52PS Switch**



|  
**AC Power  
Supply Connector**

Figure 2. Back Panels

# Management Panel

---

Figure 3 identifies the components on the management panel.

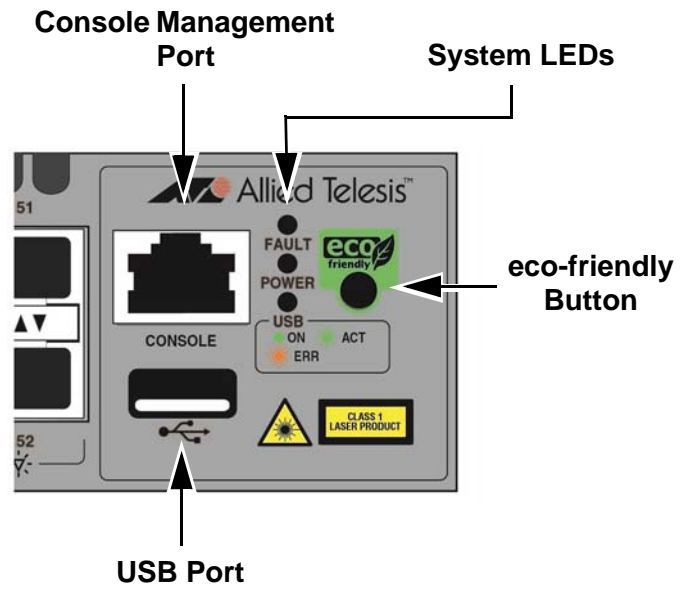

Figure 3. Management Panel

## Features

---

The following sections review the hardware features of the Gigabit Ethernet switches in the GS980M Series.

**GS980M Models** Table 1 lists the basic features.

Table 1. Basic Features

Model	10/100/1000 Mbps Twisted Pair Ports	100Mbps or 1Gbps SFP Transceiver Ports	PoE and PoE+	PoE Power Budget
AT-GS980M/52	48	4	No	-
AT-GS980M/52PS	48	4	Yes	740W

The switches come with one pre-installed power supply. It is not field-replaceable.

### 10/100/1000Mbps Twisted Pair Ports

The forty eight twisted pair ports on the AT-GS980M/52 and AT-GS980M/52PS Switches have these features:

- 10/100/1000Mbps operation
- 100 meters (328 feet) maximum operating distance per port
- Half or full-duplex mode
- Auto-Negotiation for speed and duplex mode
- Port Link/Activity (L/A) LEDs
- Automatic MDIX detection at 10 or 100Mbps.

### 100Mbps or 1Gbps SFP Transceiver Ports

The SFP transceiver ports support the following types of transceivers:

- 100Mbps (100Base-FX) or 1Gbps (1000SX/LX) single-mode or multi-mode fiber optic transceivers
- Single-port, BiDi fiber optic transceivers
- AT-SPTX 1Gbps (1000Base-TX) transceiver with RJ-45 connector for twisted pair cable

SFP transceivers must be purchased separately. For a list of supported transceivers, refer to the product data sheet on the Allied Telesis web site.

## **Power Over Ethernet**

Here are the basic features of PoE and PoE+ on the twisted pair ports on the AT-GS980M/52PS Switch:

- Supported on all forty eight twisted pair ports
- Supports PoE (15.4 watts maximum) and PoE+ (30 watts maximum) powered devices
- 740W power budget
- Supports powered device classes 0 to 4
- Mode A wiring
- IEEE802.3af and IEEE802.3at compliant

## **LEDs**

Here are the port LEDs:

- The SFP transceiver ports have link/activity LEDs.
- The twisted pair ports on the AT-GS980M/52 Switch have speed/activity and duplex mode LEDs.
- The twisted pair ports on the AT-GS980M/52PS Switch have speed/activity and PoE status LEDs.
- The management panel has system LEDs for the power supply and USB slot.

You can use the eco-friendly button to turn off the LEDs to conserve electricity.

## **Installation Options**

Here are the installation options:

- Desk or tabletop
- Standard 19-inch equipment rack
- Wood or concrete wall

## **Management Software and Interfaces**

Here are the management software and interfaces:

- AlliedWare Plus Management Software
- Command line interface
- Web browser interface

## **Console Port**

The port is used for local management of the switch. A management cable is provided with the device. The port settings are provided in “Console Port” on page 34.

**USB Port**

Here are the features and functions of the USB port:

- USB 2.0 compatible
- Store switch configuration files on flash drives.
- Restore configuration files from flash drive to switches whose settings have been lost or corrupted, or to configure replacement units.
- Update the AlliedWare Plus Management Software.

**Management  
Methods**

Here are the methods for managing the switches:

- Local management through the Console port
- Remote Telnet or Secure Shell management
- Remote HTTP or HTTPS web browser management
- SNMPv1, v2c, and v3

**Power  
Conservation**

The switches have the following power conservation features:

- eco-friendly button for turning off the Ethernet port LEDs to conserve electricity.
- High efficiency power supply

**MAC Address  
Table**

Here are the basic features of the MAC address table:

- Storage capacity of 16K MAC address entries
- Automatic learning and aging

## 10/100/1000Mbps Twisted Pair Ports

---

The following sections describe the twisted pair ports on the AT-GS980M/52 and AT-GS980M/52PS Switches.

### Connector Type

The twisted pair ports have 8-pin RJ-45 connectors. The ports use four pins at 10 or 100Mbps and all eight pins at 1000Mbps. The pin assignments are listed in “RJ-45 Twisted Pair Port Pinouts” on page 92.

### Speed

The ports can operate at 10, 100, or 1000Mbps. The switch can set the speeds automatically through Auto-Negotiation, the default setting, or you can manually configure them with the AlliedWare Plus Operating System.

---

#### Note

Twisted-pair ports have to be set to Auto-Negotiation to operate at 1000Mbps.

---

### Duplex Mode

The twisted-pair ports on the switches can operate in either half- or full-duplex mode at 10 or 100Mbps. Ports operating at 1000Mbps can only operate in full-duplex mode. The twisted-pair ports are IEEE 802.3u-compliant and use Auto-Negotiate to set the duplex mode setting.

You can disable Auto-Negotiation on the ports and set the duplex mode manually.

---

#### Note

Switch ports that are connected to 10 or 100Mbps end nodes that are not using Auto-Negotiation should not use Auto-Negotiation to set their speed and duplex mode settings, because duplex mode mismatches might occur. You should disable Auto-Negotiation and set the speed and duplex mode settings manually with the AlliedWare Plus Management Software.

---

### Maximum Distance

The ports have a maximum operating distance of 100 meters (328 feet).

### Cable Requirements

The minimum cable requirements for the ports are listed here.

- ❑ 10Mbps or 100Mbps: Standard TIA/EIA 568-B-compliant Category 3 shielded or unshielded cabling.
- ❑ 1000Mbps: Standard TIA/EIA 568-A-compliant Category 5 or TIA/EIA 568-B-compliant Enhanced Category 5 (Cat 5e) shielded or unshielded cabling.

## Automatic MDIX Detection

The 10/100/1000Mbps twisted-pair ports are IEEE 802.3ab compliant. They feature automatic MDIX detection when operating at 10 or 100Mbps. (Automatic MDIX detection does not apply to 1000Mbps.) The switch automatically configures the ports to MDI or MDI-X depending on the wiring configurations of the end nodes.

Ports connected to network devices that do not support automatic MDIX detection default to MDIX.

You can disable automatic MDIX detection on the individual ports and configure the MDI/MDI-X settings manually with the POLARITY command.

Refer to Table 18 on page 92 for the port pinouts of the twisted pair ports.

**LEDs** The twisted pair ports on the AT-GS980M/52 Switch have two LEDs. The LEDs are shown in Figure 4.

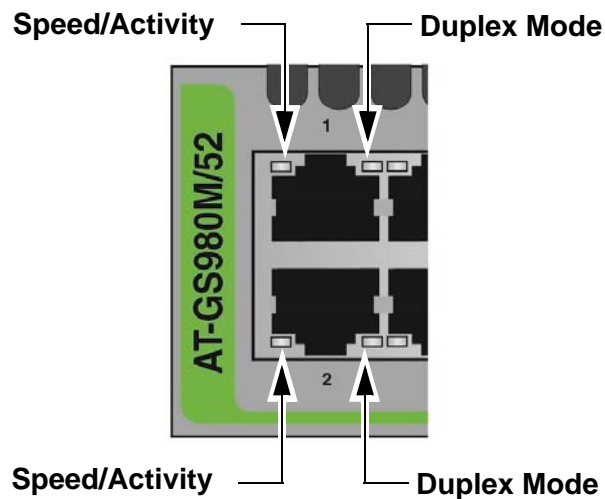

Figure 4. LEDs for the Twisted Pair Ports on the AT-GS980M/52 Switch

The states of the port LEDs are described in Table 2.

Table 2. LEDs for the Twisted Pair Ports on the AT-GS980M/52 Switch

State	Description
Speed/Activity LED	
Solid Green	The port has established a 1Gbps link to a network device.
Flashing Green	The port is transmitting or receiving packets at 1Gbps.
Solid Amber	The port has established a 10 or 100Mbps link to a network device.

Table 2. LEDs for the Twisted Pair Ports on the AT-GS980M/52 Switch

State	Description
Flashing Amber	The port is transmitting or receiving packets at 10 or 100Mbps.
Off	Possible causes of this state are listed here: - The port has not established a link with another network device. - The LEDs are turned off. To turn on the LEDs, use the eco-friendly button.
Duplex Mode LED	
Solid Green	The port is operating in full-duplex mode.
Solid Amber	The port is operating in half-duplex mode.
Flashing Amber	The port is encountering collisions in half-duplex mode.

The twisted pair ports on the AT-GS980M/52PS Switch have two LEDs. The LEDs are shown in Figure 5.

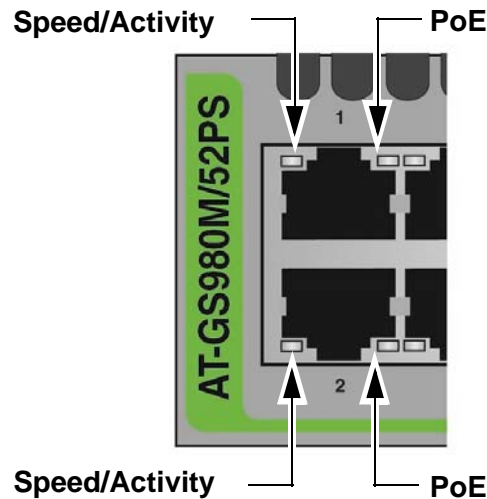

Figure 5. LEDs for the Twisted Pair Ports on the AT-GS980M/52PS Switch

The states of the port LEDs are described in Table 3 on page 25.



Table 3. LEDs for the Twisted Pair Ports on the AT-GS980M/52PS Switch

State	Description
Speed/Activity LED	
Solid Green	The port has established a 1Gbps link to a network device.
Flashing Green	The port is transmitting or receiving packets at 1Gbps.
Solid Amber	The port has established a 10 or 100Mbps link to a network device.
Flashing Amber	The port is transmitting or receiving packets at 10 or 100Mbps.
Off	Possible causes of this state are listed here: <ul style="list-style-type: none"> <li>- The port has not established a link with another network device.</li> <li>- The LEDs are turned off. To turn on the LEDs, use the eco-friendly button.</li> </ul>
PoE LED	
Solid Green	The port is delivering power to a powered device.
Solid Amber	The switch has shut down PoE on the port because of a fault condition.
Flashing Amber	The switch has detected a powered device on the port but cannot supply power to it because it is already providing its maximum power to other devices. The maximum power budget for the switch is 740W.
Off	This LED state can result from the following conditions: <ul style="list-style-type: none"> <li>- The port is not connected to a powered device or the device is powered off.</li> <li>- The port is disabled in the management software.</li> <li>- PoE is disabled on the port.</li> <li>- The LEDs are turned off. To turn on the LEDs, use the eco-friendly button.</li> </ul>

## Power Over Ethernet on the AT-GS980M/52PS Switch

---

The AT-GS980M/52PS Switch features PoE on all forty eight 10/100/1000Mbps ports. With PoE, the switch can supply DC power to network devices over the same twisted pair cables that carry the network traffic.

PoE can make it easier to install networks. The selection of a location for a network device is often limited by whether there is a power source nearby. This often limits equipment placement or requires the added time and cost of having additional electrical sources installed. But with PoE, you can install PoE-compatible devices wherever they are needed without having to worry about whether there are power sources nearby.

A device such as the AT-GS980M/52PS Switch that provides PoE to network devices is referred to as *power sourcing equipment (PSE)*. It functions as a central power source for other network devices.

Devices that receive their power from a PSE are called *powered devices (PD)*. Examples include wireless access points, IP telephones, webcams, and even other Ethernet switches.

The switch automatically determines whether or not devices connected to its ports are powered devices. Ports that are connected to network nodes that are not powered devices (that is, devices that receive their power from another power source) function as regular Ethernet ports, without PoE. The PoE feature remains activated on the ports but no power is delivered to the devices.

### PoE Standards

The AT-GS980M/52PS Switch supports these PoE standards:

- ❑ PoE (IEEE 802.3af): This standard provides up to 15.4 watts at the switch port for powered devices that require up to 12.95 watts.
- ❑ PoE+ (IEEE 802.3at): This standard provides up to 30.0 watts at the switch port for powered devices that require up to 25.5 watts.

### Powered Device Classes

Powered devices are grouped into the five classes listed in Table 4 on page 26. The classes are based on the amount of power the devices require. The switches support all five classes.

Table 4. IEEE Powered Device Classes

Class	Maximum Power Output from a Switch Port	PD Power Range
0	15.4W	0.44W to 12.95W
1	4.0W	0.44W to 3.84W

Table 4. IEEE Powered Device Classes (Continued)

Class	Maximum Power Output from a Switch Port	PD Power Range
2	7.0W	3.84W to 6.49W
3	15.4W	6.49W to 12.95W
4	30.0W	12.95W to 25.5W

## Power Budget

The AT-GS980M/52PS Switch has a DC power budget of 740W. This is the total maximum amount of power that the switch can supply to the powered devices on its twisted pair ports.

To determine the maximum number of PoE devices the switch can support at one time, compare their power requirements against its power budget. The switch can supply power to all devices provided their total power requirement is less than its power budget. If the total power requirement of the devices exceed the power budget, the switch will deny power to one or more ports using port priorities.

The switch can handle different power requirements on different ports. This enables you to connect different classes of PoE equipment to the ports on the switch.

## Port Priorities

If the switch determines that the power requirements of the powered devices exceed its power budget, it will deny power to some ports based on a system called port priorities. You can use this mechanism to ensure that powered devices critical to the operations of your network are given preferential treatment by the switch in the distribution of power should the demands of the devices exceed the available capacity.

There are three priority levels:

- Critical
- High
- Low

Ports set to the Critical level, the highest priority level, are guaranteed power before any of the ports assigned to the other two priority levels. Ports assigned to the other priority levels receive power only if all the Critical ports are receiving power. Ports that are connected to your most critical powered devices should be assigned to this level. If there is not enough power to support all the ports set to the Critical priority level, power is provided to the ports based on port number, in ascending order.

The High level is the second highest level. Ports set to this level receive

power only if all the ports set to the Critical level are already receiving power. If there is not enough power to support all of the ports set to the High priority level, power is provided to the ports based on port number, in ascending order.

The lowest priority level is Low. This is the default setting. Ports set to this level only receive power if all of the ports assigned to the other two levels are already receiving power. As with the other levels, if there is not enough power to support all of the ports set to the Low priority level, power is provided to the ports based on port number, in ascending order.

Power allocation is dynamic. Ports supplying power to powered devices may cease power transmission if the switch's power budget is at maximum usage and new powered devices, connected to ports with higher priorities, become active.

## **Wiring Implementation**

The IEEE 802.3af standard defines two methods for delivering DC power over twisted pair cable by a switch to powered devices. These methods are known as Modes A and B. They identify the individual wires that carry the DC power within the network cables from the switch to powered devices.

Twisted pair cabling typically consists of eight wires. With 10Base-T and 100Base-TX devices, the wires connected to pins 1, 2, 3, and 6 on the RJ-45 connectors carry the network traffic while the wires connected to pins 4, 5, 7, and 8 are unused. With 1000Base-T devices, all eight wires are used to carry network data.

It takes four wires to deliver DC power to a powered device. With Mode A, power is delivered on pins 1, 2, 3, and 6. These are the same pins in 10Base-T and 100Base-TX devices that carry the network data. With Mode B, power is provided over the spare wires.

The ports on the AT-GS980M/52PS Switch deliver power using Mode A.

Powered devices that comply with the IEEE 802.3af standard are required to support both Modes A and B. Legacy devices that do not comply with the standard will work with the switch if they are powered on pins 1, 2, 3, and 6.

## SFP Transceiver Ports

The switches have four SFP transceiver ports.

### SFP Transceivers

The transceiver ports support 100Mbps and 1Gbps SX/LX SFP transceivers

- ❑ 100Mbps or 1000Base single-mode or multi-mode fiber optic transceivers
- ❑ 100Mbps or 1000Mbps bi-directional (BiDi) fiber optic transceivers
- ❑ 1000Base-TX transceivers with RJ-45 connectors for twisted pair cable

SFP transceivers are purchased separately. For a list of supported transceivers, refer to the product data sheet on the Allied Telesis web site.

**LEDs** Each transceiver port has one LED. Refer to Figure 6.

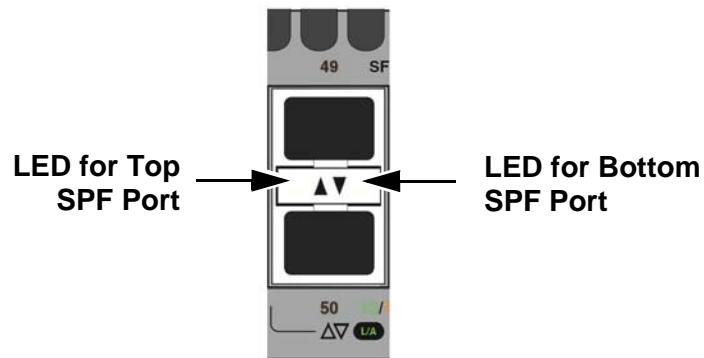

Figure 6. SFP Transceiver Port LEDs

The LED states are described in Table 5.

Table 5. LEDS for the SFP Transceiver Ports

State	Description
Solid green	The port has established a 1Gbps link to a network device.
Flashing green	The port is transmitting or receiving packets at 1Gbps.
Solid amber	The port has established a 100Mbps link to a network device.
Flashing amber	The port is transmitting or receiving packets at 100Mbps.

Table 5. LEDS for the SFP Transceiver Ports (Continued)

<b>State</b>	<b>Description</b>
Off	Possible causes of this state are listed here: <ul style="list-style-type: none"><li>- The SFP transceiver port is empty.</li><li>- The SFP transceiver has not established a link with another network device.</li><li>- The LEDs are turned off. To turn on the LEDs, use the eco-friendly button.</li></ul>

## Fault and Power LEDs

The Fault and Power LEDs are shown in Figure 7.

### Fault and Power LEDs

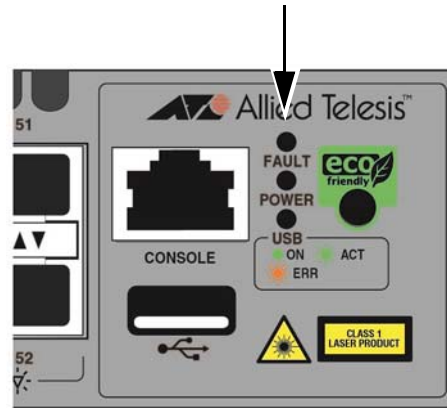

Figure 7. Fault and Power LEDs

#### Note

The USB LED is described in “USB Port” on page 33.

The states of the LEDs are described in Table 6.

Table 6. Fault and Power LEDs

State	Description
Fault LED	
Off	The switch is operating normally or is not powered on.
Flashing Amber	The power supply or switch is experiencing a problem, such as overheating. To troubleshoot the problem, view the log messages by displaying the system log file.
Power LED	
Solid Green	The power supply and switch are operating normally.
Off	The switch is powered off or the input power is outside the normal operating range.

## eco-friendly Button

---

The eco-friendly button on the front panel of the switch is used to toggle the port LEDs on or off. Refer to Figure 8. You can turn off the LEDs to conserve electricity when you are not using them to monitor the device. You can also toggle the LEDs with the ECOFRIENDLY LED and NO ECOFRIENDLY LED commands in the Global Configuration mode of the command line interface of the AlliedWare Plus management software.

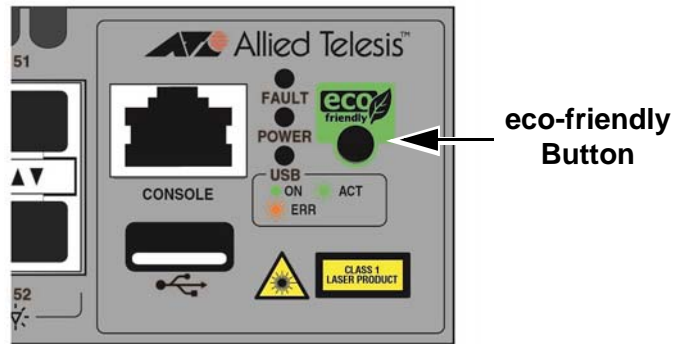

Figure 8. eco-friendly Button

The switch is operating in a low power mode when the LEDs are turned off. The low power mode does not interfere with the network operations of the device.

The management software on the switch has a command that blinks the LEDs so that you can quickly and easily identify a specific unit among the devices in an equipment rack. It is the FINDME command. The command works even when the switch is operating in the low power mode, with the port LEDs turned off.

---

### Note

Before checking or troubleshooting network connections to ports on the switch, you should always check to be sure that the LEDs are on by either pressing the eco-friendly button or issuing the ECOFRIENDLY LED and NO ECOFRIENDLY LED commands in the Global Configuration mode in the command line interface.

---



## USB Port

You can use the USB port on the management panel for the following functions:

- ❑ Store configuration files on flash drives.
- ❑ Restore configuration files to switches whose settings have been lost or corrupted.
- ❑ Configure replacement units by downloading configuration files from a flash drive.
- ❑ Update the AlliedWare Plus management software.

The port is USB2.0 compatible.

**USB Port LED** The USB port has one LED, shown in Figure 9.

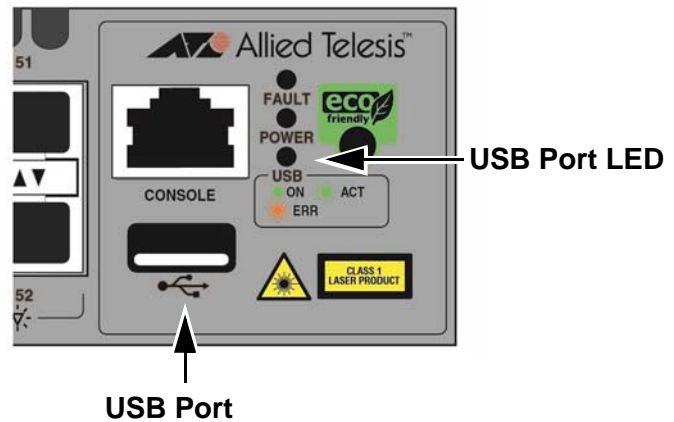

Figure 9. USB Port and LED

The states of the LEDs are described in Table 2.

Table 7. USB LED

State	Description
Off	The USB slot is empty.
Solid green	A USB drive is inserted in the slot.
Flashing green	The switch is writing data to or reading data from the USB drive.
Flashing amber	The switch is experiencing problems writing data to or reading data from the USB drive.

## Console Port

---

The Console port is an RS232 serial management port. You use the port to access the AlliedWare Plus management software on the switch to configure the feature settings or monitor status or statistics. This type of management uses the management cable included with the unit. It requires that you be at the physical location of the switch. The switch does not have to have an IP address for local management.

To establish a local management session with the switch, you use the provided management cable to connect a terminal or a personal computer with a terminal emulation program to the Console port, which has an RJ-45 style (8P8C) connector. The cable has RJ-45 style (8P8C) and DB-9 (D-sub 9-pin) connectors.

The Console port has the following settings:

- Default baud rate: 9600 bps (The baud rates of the port are 9600, 19200, 38400, 57600, and 115200 bps.)
- Data bits: 8
- Parity: None
- Stop bits: 1
- Flow control: None

---

**Note**

These settings are for a DEC VT100 or ANSI terminal, or an equivalent terminal emulation program.

---

## Power Supply and Fan

---

The switches come with one pre-installed power supply. Refer to “Technical Specifications” on page 87 for the input voltage ranges. A power cord and retaining clip are included with the switch.

**Warning**

Power cord is used as a disconnection device. To de-energize equipment, disconnect the power cord. *⚡* E3

---

**Note**

The power supply is not field-replaceable.

---

The switches have one ventilation fan located on the back panel. It is not field-replaceable. The airflow direction is from front to back, with the fan drawing air out of the switch. Problems with the fan are displayed with the Fault LED. Refer to “Fault and Power LEDs” on page 31.

## Specifying Ports in the Command Line Interface

The individual ports on the switches are specified with the PORT parameter in the command line interface of the AlliedWare Plus management software. The format of the parameter is shown in Figure 10.

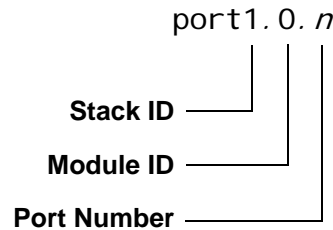

Figure 10. PORT Parameter in the Command Line Interface

The three parts of the PORT parameter are described in Table 8.

Table 8. PORT Parameter Format

Number	Description
Stack ID	Designates the switch’s ID number. This value is always “1” for GS980M switches.
Module ID	Designates the module number of a port. This value is always 0 (zero) for GS980M switches.
Port Number	Designates a port number.

The format of the PORT parameter is the same for both twisted pair ports and SFP transceiver ports.

Here is an example of the PORT parameter. It uses the INTERFACE command to enter the Port Interface mode for ports 15 and 17:

```
awpl us> enable
awpl us# configure terminal
awpl us(config)# interface port1.0.15, port1.0.17
```

For instructions on the command line interface and the PORT parameter, refer to the *Software Reference for GS980M Series Switches, AlliedWare Plus Operating System*.

## Chapter 2

# Beginning the Installation

---

The chapter contains the following sections:

- “Reviewing Safety Precautions” on page 38
- “Installation Options” on page 42
- “Choosing a Site for the Switch” on page 43
- “Unpacking the Switch” on page 44

## Reviewing Safety Precautions

---

Please review the following safety precautions before beginning the installation procedure.

---

### Note

Safety statements with the  symbol are translated into multiple languages in the *Translated Safety Statements* document at [www.alliedtelesis.com/library](http://www.alliedtelesis.com/library).

---



---

### Warning

Class 1 Laser product.  L1

---



---

### Warning

Laser Radiation.  
Class 1M Laser product.

---



---

### Warning

Do not stare into the laser beam.  L2

---



---

### Warning

Do not look directly at the fiber optic ends or inspect the cable ends with an optical lens.  L6

---



---

### Warning

To prevent electric shock, do not remove the cover. No user-serviceable parts inside. This unit contains hazardous voltages and should only be opened by a trained and qualified technician. To avoid the possibility of electric shock, disconnect electric power to the product before connecting or disconnecting the LAN cables.  E1

---



---

### Warning

Do not work on equipment or cables during periods of lightning activity.  E2

---

**Warning**

Power cord is used as a disconnection device. To de-energize equipment, disconnect the power cord. ⚡ E3

---

**Warning**

Class I Equipment. This equipment must be earthed. The power plug must be connected to a properly wired earth ground socket outlet. An improperly wired socket outlet could place hazardous voltages on accessible metal parts. ⚡ E4

---

**Note**

Pluggable Equipment. The socket outlet shall be installed near the equipment and shall be easily accessible. ⚡ E5

---

**Caution**

Air vents must not be blocked and must have free access to the room ambient air for cooling. ⚡ E6

---

**Warning**

Operating Temperatures. This product is designed for a maximum ambient temperature of 50° degrees C. ⚡ E52

---

**Note**

All Countries: Install product in accordance with local and National Electrical Codes. ⚡ E8

---

**Warning**

Only trained and qualified personnel are allowed to install or replace this equipment. ⚡ E14

---

**Caution**

Circuit Overloading: Consideration should be given to the connection of the equipment to the supply circuit and the effect that overloading of circuits might have on overcurrent protection and supply wiring. Appropriate consideration of equipment nameplate ratings should be used when addressing this concern. ⚡ E21

---



**Caution**

Risk of explosion if battery is replaced by an incorrect type. Replace only with the same or equivalent type recommended by the manufacturer. Dispose of used batteries according to the manufacturer's instructions.

**Attention:** Le remplacement de la batterie par une batterie de type incorrect peut provoquer un danger d'explosion. La remplacer uniquement par une batterie du même type ou de type équivalent recommandée par le constructeur. Les batteries doivent être éliminées conformément aux instructions du constructeur.  E22

---



**Warning**

Mounting of the equipment in the rack should be such that a hazardous condition is not created due to uneven mechanical loading.  E25

---



**Warning**

The chassis may be heavy and awkward to lift. Allied Telesis recommends that you get assistance when mounting the chassis in an equipment rack.  E28

---

---

**Note**

Use dedicated power circuits or power conditioners to supply reliable electrical power to the device.  E27

---



**Warning**

This unit might have more than one power cord. To reduce the risk of electric shock, disconnect all power cords before servicing the unit.  E30

---

---

**Note**

If installed in a closed or multi-unit rack assembly, the operating ambient temperature of the rack environment may be greater than the room ambient temperature. Therefore, consideration should be given to installing the equipment in an environment compatible with the manufacturer's maximum rated ambient temperature (T<sub>mra</sub>).  E35

---



**Caution**

Installation of the equipment in a rack should be such that the amount of air flow required for safe operation of the equipment is not compromised. E36

---

**Warning**

Reliable earthing of rack-mounted equipment should be maintained. Particular attention should be given to supply connections other than direct connections to the branch circuits (e.g., use of power strips). E37

---

**Warning**

To reduce the risk of electric shock, the PoE ports on this product must not be connected to cabling that is routed outside the building where this device is located. E40

---

**Warning**

This product may have multiple AC power cords installed. To de-energize this equipment, disconnect all power cords from the device. E41

---

**Caution**

An Energy Hazard exists inside this equipment. Do not insert hands or tools into open chassis slots or plugs. E44

---

**Warning**

This equipment shall be installed in a Restricted Access location. E45

---

**Caution**

The unit does not contain serviceable components. Please return damaged units for servicing. E42

---

**Warning**

The temperature of an operational SFP or SFP+ transceiver may exceed 70° C (158° F). Exercise caution when removing or handling transceivers with unprotected hands. E43

---

## Installation Options

---

Figure 11 illustrates the three installation options.



**Tabletop**

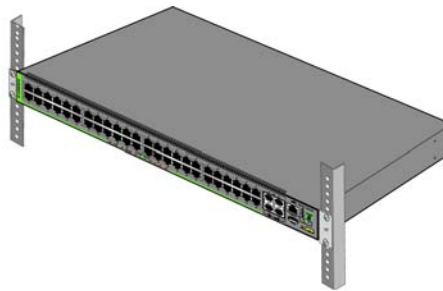

**Standard 19-inch  
equipment rack**

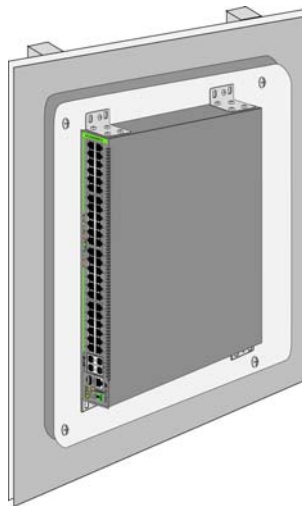

**Wood or  
concrete wall**

Figure 11. Installation Options

## Choosing a Site for the Switch

---

Observe these requirements when planning the installation of the switch.

- ❑ Before installing the switch in an equipment rack, check that the rack is safely secured so that it will not tip over. Devices in a rack should be installed starting at the bottom of the rack, with the heavier devices near the bottom.
- ❑ Before installing the switch on a table, verify that the table is level and stable.
- ❑ Before installing the switch on a wall, verify that the wall's material is strong enough to hold the switch's weight. You should position the device so that it can be screwed into the wall's framing timber or equivalent structural element.
- ❑ The power outlet should be located near the switch and be easily accessible.
- ❑ The site should allow for easy access to the ports on the front of the switch so that you can easily connect and disconnect cables, and view the port LEDs.
- ❑ The site should allow for adequate air flow around the unit and through the cooling vents on the front and rear panels. (The ventilation direction is from front to back.)
- ❑ Do not place objects on top of the switch.
- ❑ The site should not expose the switch to moisture or water.
- ❑ The site should be a dust-free environment.
- ❑ The site should use dedicated power circuits or power conditioners to supply reliable electrical power to the network devices.
- ❑ Do not install the switch in a wiring or utility box that does not have adequate airflow. The switch might overheat and shutdown.



### Warning

Switches should not be stacked on a table or desktop. They could present a physical safety hazard if you need to move or replace switches. *GR* E91

---

## Unpacking the Switch

---

Figure 12 shows the shipping box.

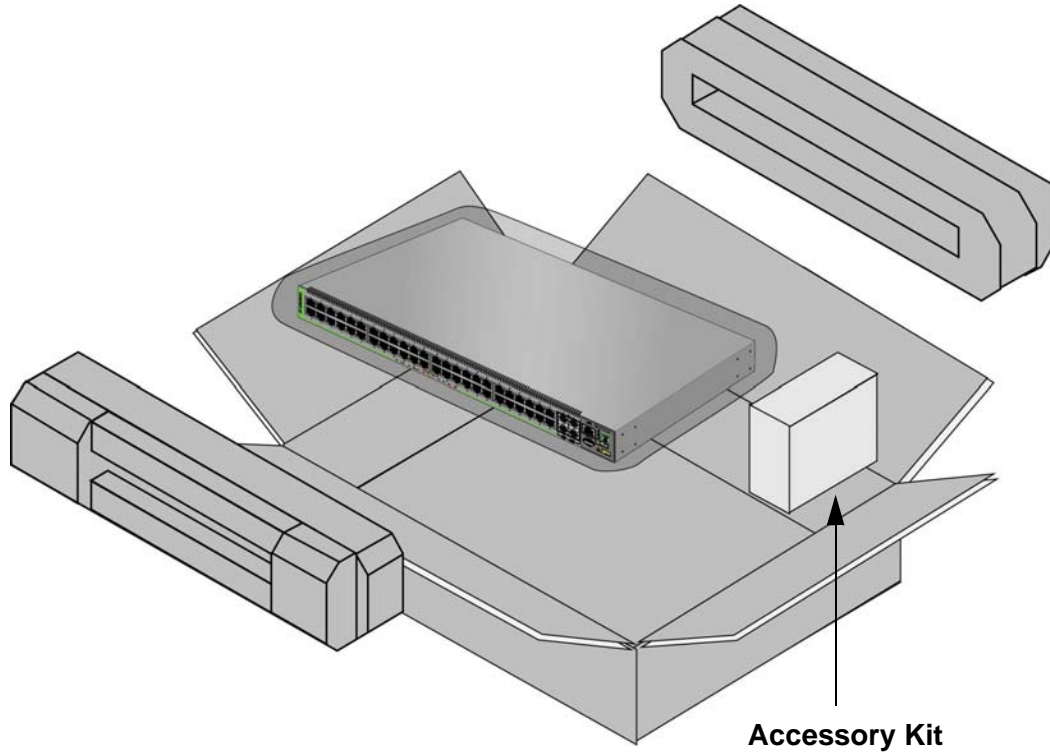

Figure 12. GS980M Switch Shipping Box

---

**Note**

You should retain the original packaging material in case you need to return the unit to Allied Telesis.

---

Figure 13 on page 45 lists the items in the accessory kit. Contact your Allied Telesis sales representative for assistance if any item is missing or damaged.

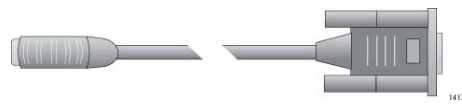

One 2m (6.6 ft) local management cable with RJ-45 (8P8C) and DB-9 (D-sub 9-pin) connectors.



One regional AC power cords

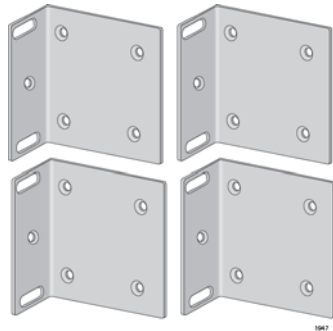

Four wall/equipment rack brackets



Sixteen screws for attaching the wall/equipment rack brackets to the switch.  
Length: 6.0mm (0.2 in.)  
Diameter: 4.0mm (0.2 in.)



Four anchors for concrete walls:  
Length: 29.6mm (1.2 in.)  
Diameter: 6.0mm (0.2 in.)



Four screws for wood or concrete walls:  
Length: 32mm (1.3 in.)  
Diameter: 4mm (0.2 in.)



Power cord retaining clip

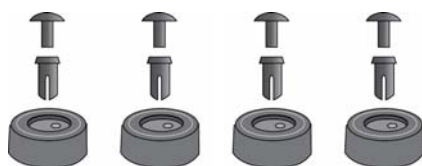

Four bumper feet with rivets

Figure 13. Accessory Kit Items



## Chapter 3

# Installing the Switch on a Table or Desktop

---

This chapter contains the instructions for installing the switch on a table or desktop.



### Warning

Switches should not be stacked on a table or desktop. They could present a physical safety hazard if you need to move or replace switches. *ES* E91

---

The bumper feet for the bottom of the switch are reusable. If they are already assembled, disassemble them by removing the rivets and rivet housings from the bumper feet and then the rivets from the housings. Refer to Figure 14.

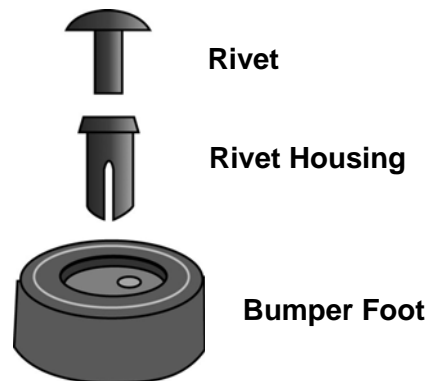

Figure 14. Parts of the Bumper Feet

To install the chassis on a table, perform the following procedure:

1. Review the procedure in Chapter 2, “Choosing a Site for the Switch” on page 43 to verify that the selected site is suitable for the unit.
2. Verify that the table is strong enough to support the weight of the switch.
3. Verify that the accessory kit came with all the appropriate items. Refer to Figure 13 on page 45.
4. Lift the chassis from the shipping box and place it upside down on a table.

5. Install the bumper feet as follows:

- a. Inset a rivet housing into a bumper foot. Refer to Figure 15.

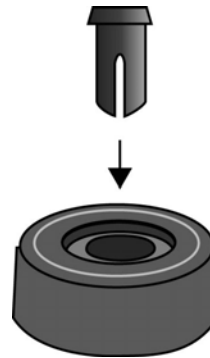

Figure 15. Inset the Rivet Housing into the Bumper Foot

- b. Place the bumper foot on one of the corner holes in the base of the switch. Refer to Figure 16.

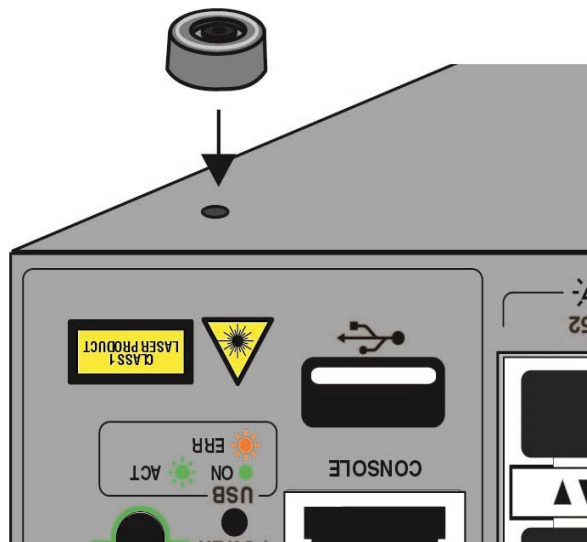

Figure 16. Place the Bumper Foot on a Base Corner Hole

- c. Insert the rivet to secure the bumper foot to the base. Refer to Figure 17 on page 49.



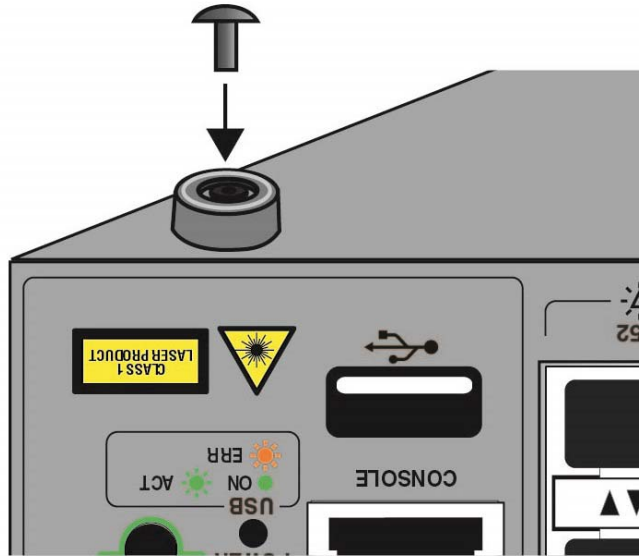

Figure 17. Inserting the Rivet into the Bumper Foot

- d. Repeat this step to install the remaining bumper feet.
6. Turn the switch over and place it on a flat, secure desk or table, leaving ample space around it for ventilation.
7. Go to Chapter 6, “Cabling the Networking Ports and Powering On the Switch” on page 69.



## Chapter 4

# Installing the Switch in an Equipment Rack

---

This chapter contains the instructions for installing the switch in a standard 19-inch equipment rack. The procedures in this chapter are listed here:

- “Beginning the Installation” on page 52
- “Removing the Bumper Feet” on page 54
- “Installing the Switch” on page 55

## Beginning the Installation

---

This chapter contains the procedure for installing the switch in a standard 19-inch equipment rack, with the brackets included with the unit.

### Required Items

The following items are required to install the switch in an equipment rack:

- Two equipment rack brackets (included with the switch)
- Eight M4x6mm bracket screws (included with the switch)
- Cross-head screwdriver (not provided)
- Four standard equipment rack screws (not provided)

### Switch Orientations in the Equipment Rack

The switch has two sets of four screw holes on the left and right sides, for attaching the brackets. Refer to Figure 18.

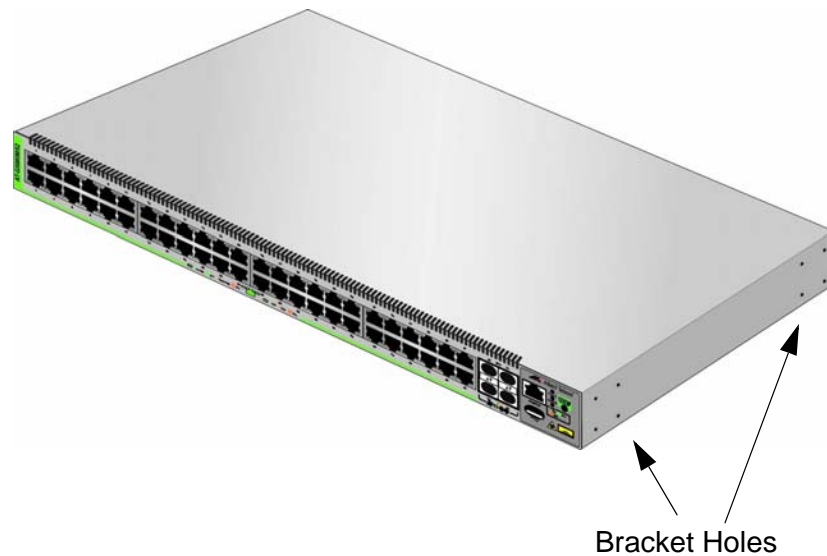

Figure 18. Bracket Holes on the Switch

You can use the sets of holes on the switch to install the switch in the equipment rack in different orientations. You can install it with the front panel flush with, extending in front of, or recessed behind the front of the equipment rack. Refer to Figure 19 on page 53.

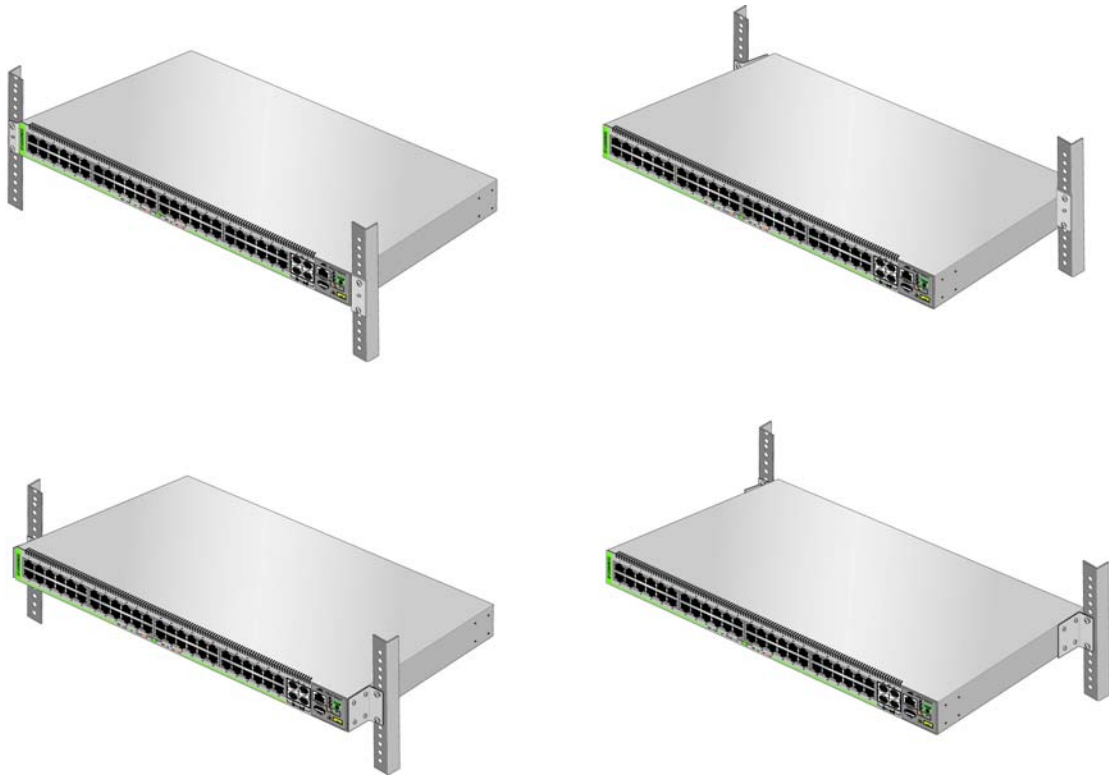

Figure 19. GS980M Switch Orientations in an Equipment Rack

## Removing the Bumper Feet

---

The bumper feet included with the switch should not be used when installing the device in an equipment rack. If they are already installed, perform the following procedure to remove them:

1. Place the switch upside down on a level, secure surface.
2. Use a small flat-head screwdriver to pry the feet from the bottom of the switch. Refer to Figure 20.

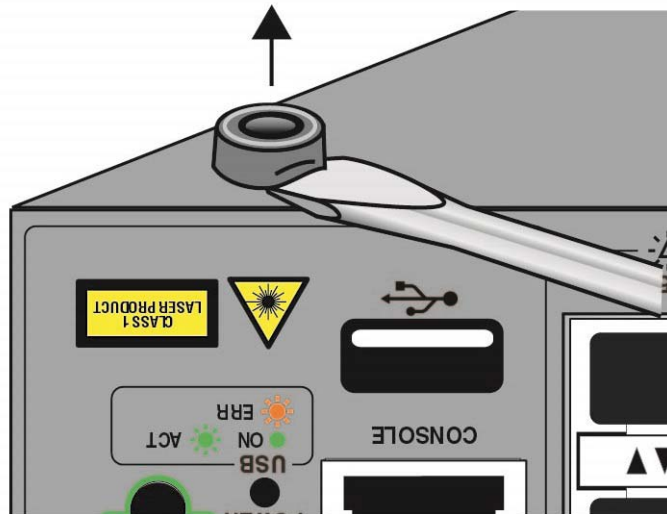

Figure 20. Removing the Bumper Feet

3. Turn the switch back over.
4. Go to "Installing the Switch" on page 55.

## Installing the Switch

---

Please review the installation guidelines in “Choosing a Site for the Switch” on page 43 before installing the switch.



### Caution

The chassis may be heavy and awkward to lift. Allied Telesis recommends that you get assistance when mounting the chassis in an equipment rack. *⚠ E28*

---

To install the switch in a 19-inch equipment rack, perform the following procedure:

1. Place the switch on a level, secure surface.
2. If you have not chosen an orientation for the switch in the equipment rack, review “Switch Orientations in the Equipment Rack” on page 52.
3. Attach two brackets to the sides of the switch in the selected position, using eight of the M4x6mm screws included with the unit. The illustration in Figure 21 shows the installation of the brackets so that the front panel of the switch is even with the front of the equipment rack.



Figure 21. Example of Attaching the Brackets to the Switch

4. Have another person hold the switch at the desired location in the equipment rack while you secure it using four standard equipment rack screws (not provided). Refer to Figure 22 on page 56.

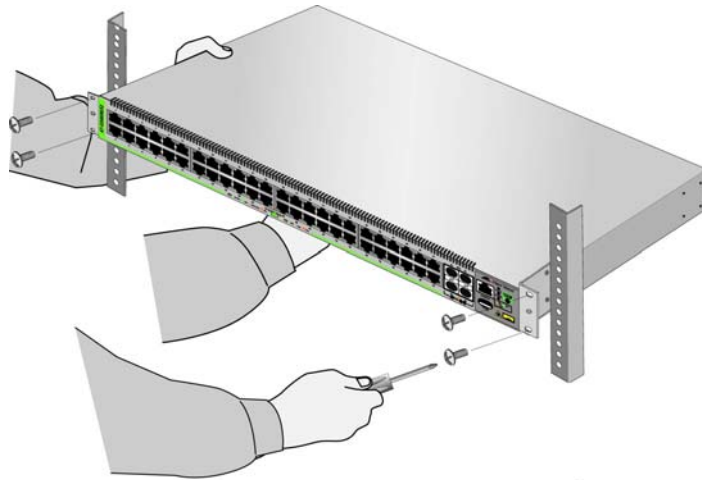

Figure 22. Installing the Switch in an Equipment Rack

5. Go to Chapter 6, “Cabling the Networking Ports and Powering On the Switch” on page 69.



## Chapter 5

# Installing the Switch on a Wall

---

The procedures in this chapter are listed here:

- ❑ “Switch Orientations on a Wall” on page 58
- ❑ “Installation Guidelines” on page 59
- ❑ “Plywood Base” on page 61
- ❑ “Installing a Plywood Base” on page 63
- ❑ “Installing the Switch on a Plywood Base” on page 64
- ❑ “Installing the Switch on a Concrete Wall” on page 66

## Switch Orientations on a Wall

---

You can install the switch on a wall with the front panel on the left or right, as shown in Figure 23. Do not install it with the front panel on the top or bottom.

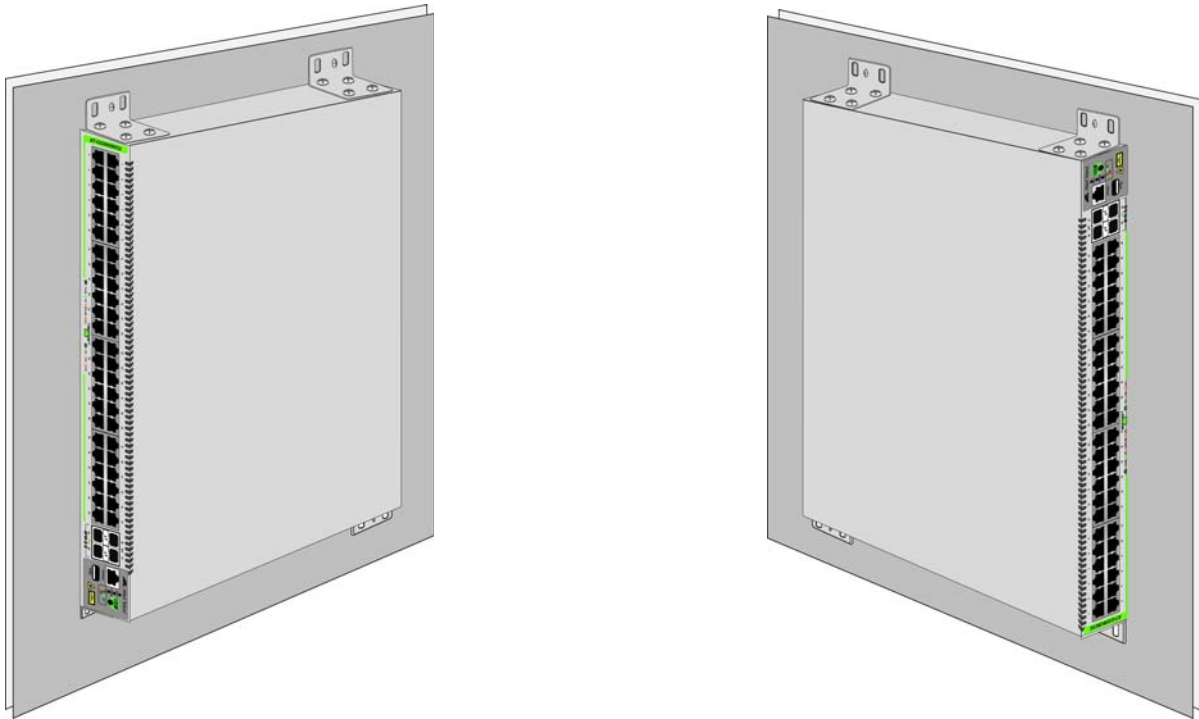

Figure 23. Positioning the Switch on a Wall

## Installation Guidelines

---

Here are guidelines to installing the switch on a wall:

- You can install the switch on a wall with wooden studs or on a concrete wall.
- If you are installing the switch on a wall with wooden studs, you should use a plywood base to support the switch. For more information, refer to “Plywood Base” on page 61. A plywood base is not required for a concrete wall.
- You should not install the switch on a wall that has metal studs. Metal studs may not be strong enough to safely support the device.
- You should not install the switch on sheetrock or similar material. Sheetrock is not strong enough to safely support the device.



### Warning

The device is heavy. Always ask for assistance before moving or lifting it to avoid injuring yourself or damaging the equipment.

---



### Warning

The device should be installed on a wall by a qualified building contractor. Serious injury to yourself or others or damage to the equipment may result if it is not properly fastened to the wall. *⚠*  
E105

---



---

### Note

Before starting, verify that the wall is sturdy enough to hold the switch’s weight. You should position the switch so that it can be screwed into the wall’s framing timber or equivalent structural element. The wall location must provide adequate space to the front and back panels so that you can service the unit, and for ventilation.

---

## Tools and Material

Here are the required tools and material for installing the switch on a wall:

- Four wall/equipment rack brackets and sixteen screws (included with the switch)
- Four wood or concrete wall screws (included with the switch)
- Four concrete wall anchors (included with the switch)
- Cross-head screwdriver (not provided)
- Flat-head screwdriver (not provided)
- Stud finder for a wooden wall, capable of identifying the middle of

wall studs and hot electrical wiring (not provided)

- Drill and 1/4" carbide drill bit for a concrete wall (not provided)
- Plywood base (not provided) for installing the switch on a wall with wooden studs. Refer to "Plywood Base" on page 61.
- Four screws for attaching the plywood base (not provided)



**Caution**

The supplied screws and anchors might not be suitable for all walls. A qualified building contractor should determine the hardware requirements of your wall prior to installing the switch. *GE* E88

---

## Plywood Base

---

If you are installing the switch on a wall with wooden studs, Allied Telesis recommends using a plywood base for the device. (A plywood base is not required for a concrete wall.) Refer to Figure 24.

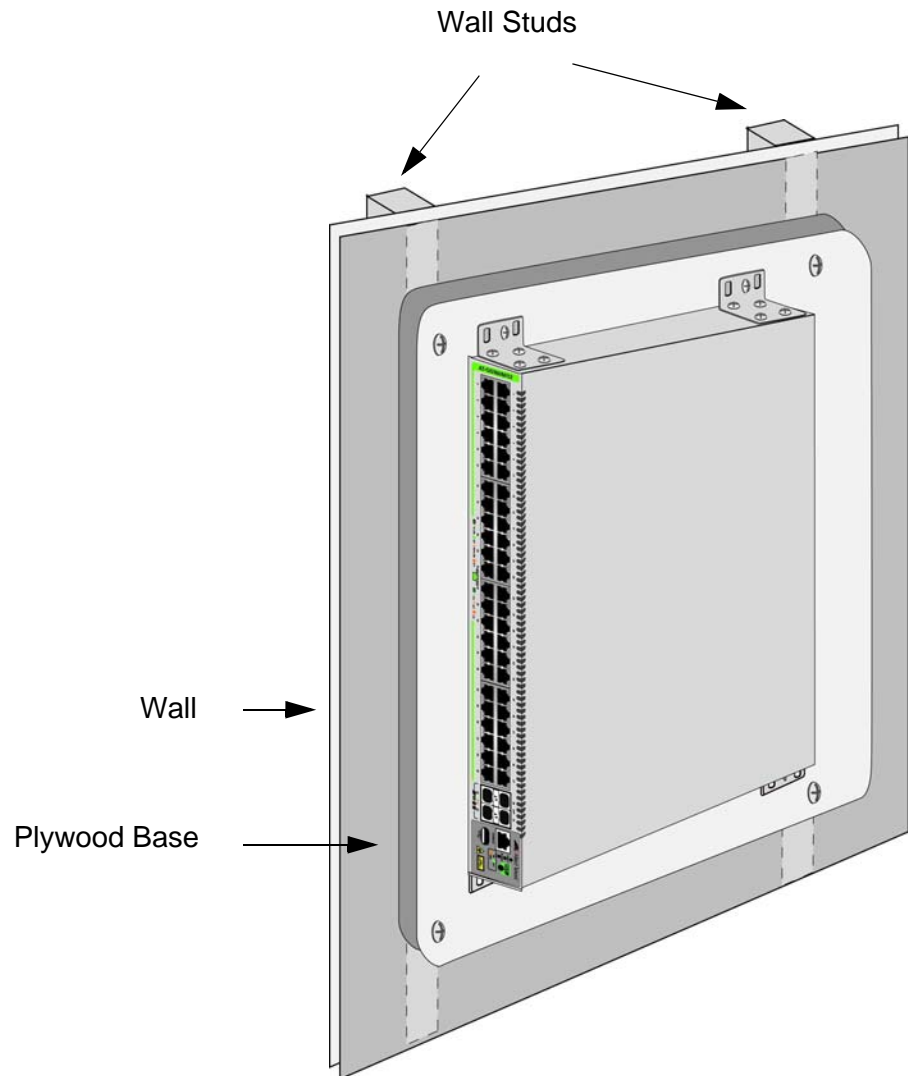

Figure 24. Switch on a Wall with a Plywood Base

The plywood base should be mounted to two studs in the wall. The recommended minimum dimensions of the plywood base for GS980M Series switches are listed here:

- ❑ Width: 55.9 centimeters (22 inches)
- ❑ Height: 61.0 centimeters (24 inches)
- ❑ Thickness: 2.5 centimeters (1 inch)

The dimensions assume the wall studs are 41 centimeters (16 inches) apart. You might need to adjust the width of the base if the distance between the studs in your wall is different than the industry standard.

You should install the plywood base on the wall and then install the switch on the base. Refer to Figure 25.

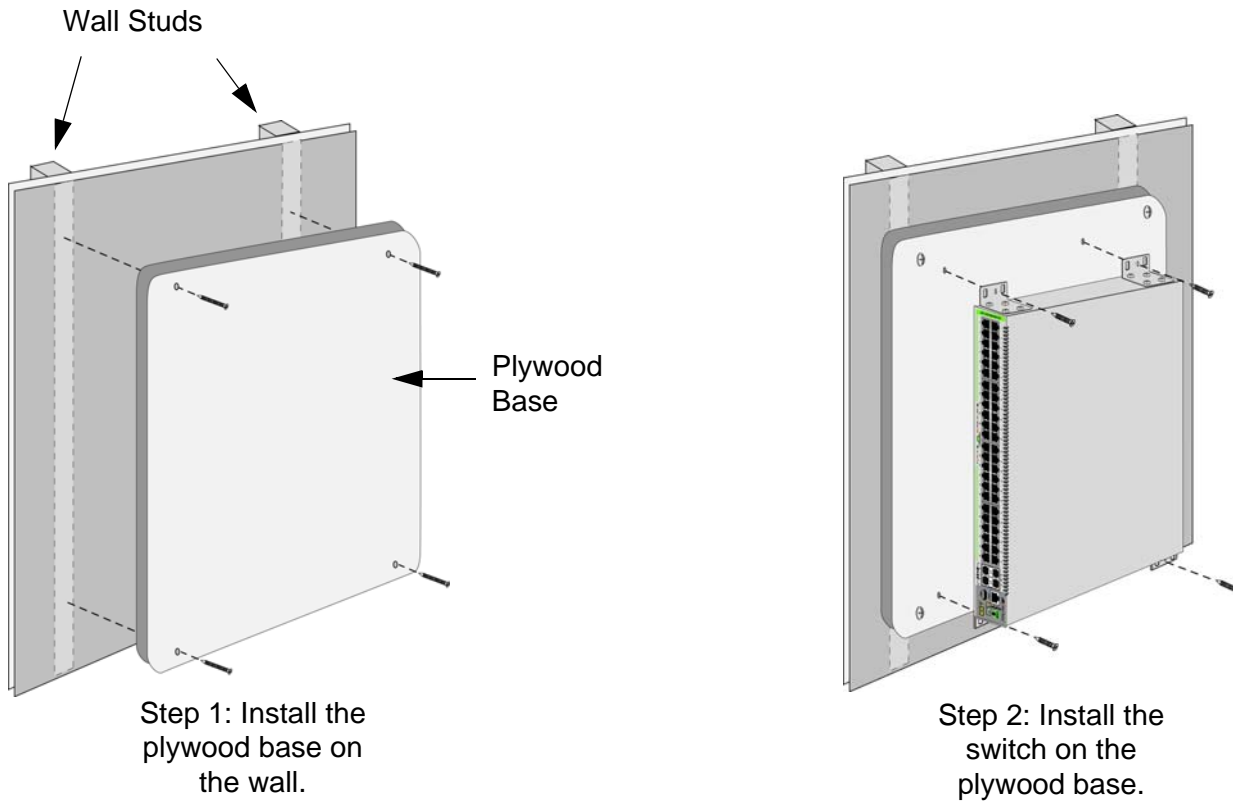

Figure 25. Steps to Installing the Switch with a Plywood Base

## Installing a Plywood Base

---

A plywood base is recommended when installing the switch on a wall that has wooden studs. Refer to “Plywood Base” on page 61. Consult a qualified building contractor for installation instructions for the plywood base. The installation guidelines are listed here:

- ❑ You should use a stud finder to identify the middle of studs and hot electrical wiring in the wall.
- ❑ You should attach the base to two wall studs with a minimum of four screws.
- ❑ The selected wall location for the base should provide sufficient space from other devices or walls so that you can access the front and back panels, and for adequate air flow for ventilation.

## Installing the Switch on a Plywood Base

---

This procedure assumes that the plywood base for the switch is already installed on the wall. Please review “Reviewing Safety Precautions” on page 38 and “Choosing a Site for the Switch” on page 43 before performing this procedure. Allied Telesis recommends a minimum of two people for this procedure.



### Warning

The device is heavy. Always ask for assistance before moving or lifting it to avoid injuring yourself or damaging the equipment.

---



### Warning

The device should be installed on the wall by a qualified building contractor. Serious injury to yourself or others or damage to the equipment may result if it is not properly fastened to the wall. *ET*  
E105

---

To install the switch on the plywood base, perform the following procedure:

1. Place the switch in a table.
2. Install the four wall/equipment rack brackets to the sides of the unit with the sixteen M4x6mm screws included with the switch. Refer to Figure 26.

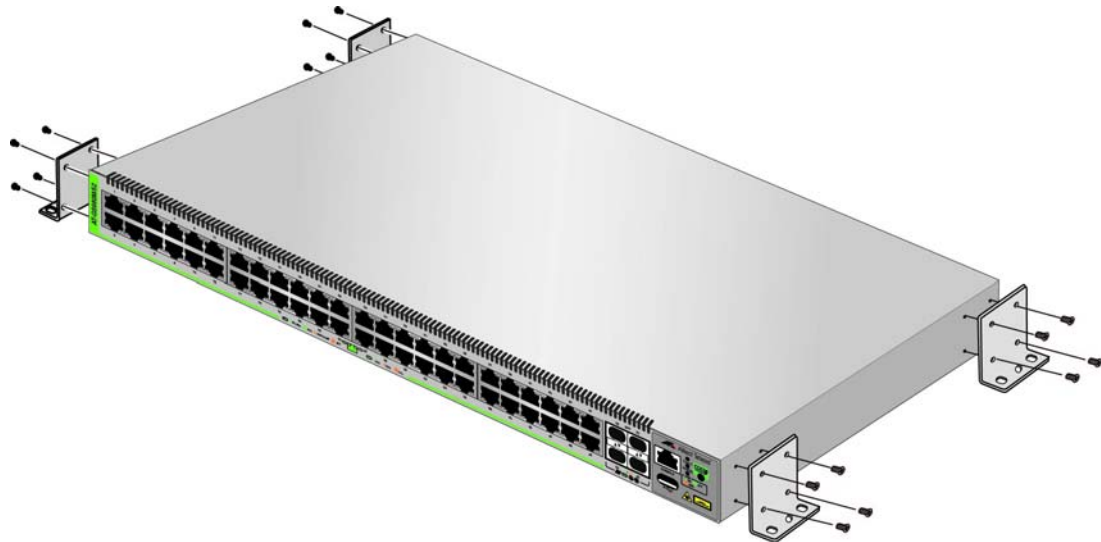

Figure 26. Bracket Positions for Installing Switch on a Wall



3. Have another person hold the switch on the plywood base on the wall while you secure it with the four M4x32.3mm screws included with the switch. Refer to Figure 27.

Please follow these guidelines as you position the switch on the wall:

- ❑ Position it so that the front panel is either on the left or right. Refer to Figure 23 on page 58. Do not install it with the front panel facing up or down.
- ❑ Leave sufficient space from other devices or walls so that you can access the front and back panels, and for adequate air ventilation.

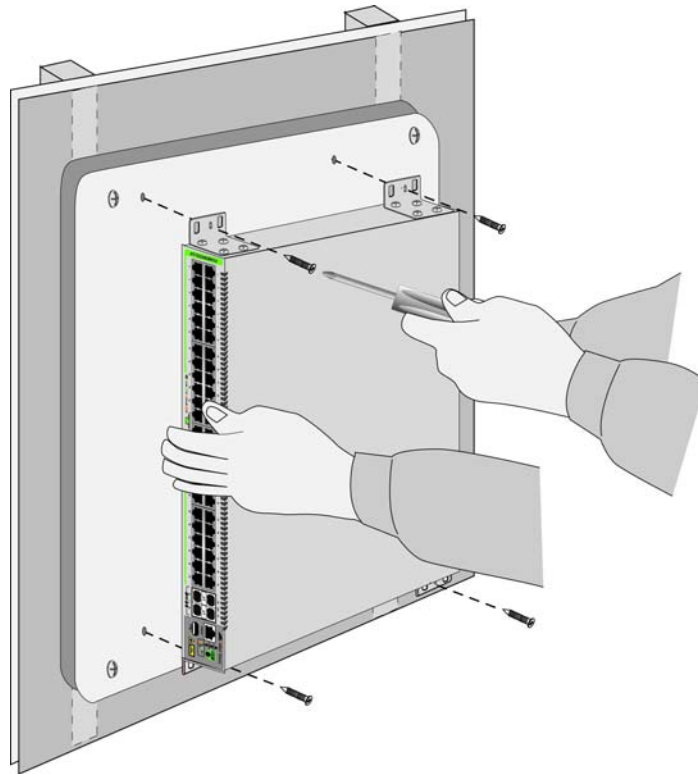

Figure 27. Securing the Switch to the Plywood Base

4. Go to Chapter 6, “Cabling the Networking Ports and Powering On the Switch” on page 69.

## Installing the Switch on a Concrete Wall

---

This section contains the instructions for installing the switch on a concrete wall. Please review the information in the following sections before performing the procedure:

- ❑ “Switch Orientations on a Wall” on page 58
- ❑ “Installation Guidelines” on page 59



### Warning

The device is heavy. Always ask for assistance before moving or lifting it to avoid injuring yourself or damaging the equipment.

---



### Warning

The device should be installed on the wall by a qualified building contractor. Serious injury to yourself or others or damage to the equipment may result if it is not properly fastened to the wall. *ES*  
E105

---

To install the switch on a concrete wall, perform the following procedure:

1. Place the switch in a table.
2. Install the four wall/equipment rack brackets to the sides of the unit with the sixteen M4x6mm screws included with the switch. Refer to Figure 26 on page 64.
3. Have another people hold the switch on the concrete wall at the selected location for the device while you use a pencil or pen to mark the wall with the locations of the four screw holes in the four brackets (one screw per bracket). Refer to Figure 28 on page 67.

Please follow these guidelines as you position the switch on the wall:

- ❑ Position the switch so that the front panel is either on the left or the right. Refer to Figure 23 on page 58. You may not install the switch with the front panel facing up or down.
- ❑ Leave sufficient space from other devices or walls so that you can access the front and back panels, and for adequate air ventilation.

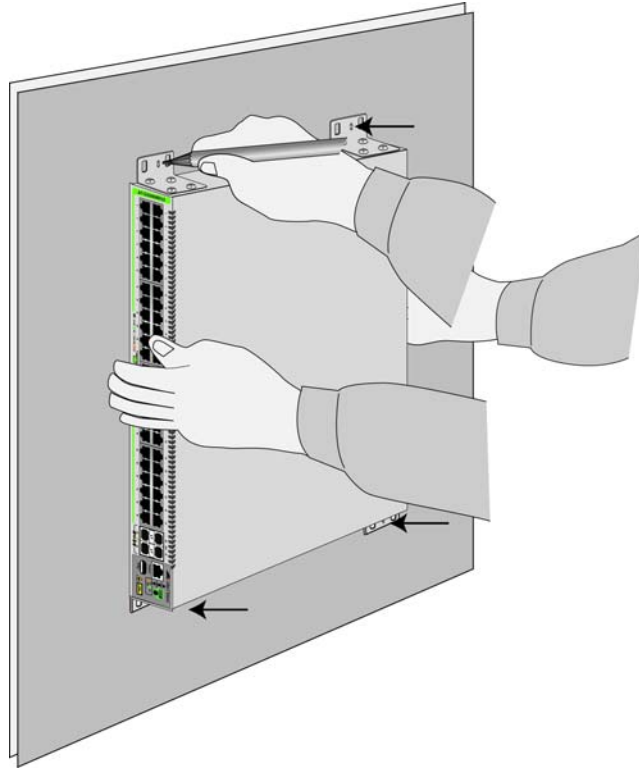

Figure 28. Marking the Locations of the Bracket Holes on a Concrete Wall

4. Place the switch on a table or desk.
5. Use a drill and 1/4" carbide drill bit to pre-drill the holes you marked in step 4. Please review the following guidelines:
  - ❑ Prior to drilling, set the drill to hammer and rotation mode. The modes break up the concrete and clean out the hole.
  - ❑ Allied Telesis recommends cleaning out the holes with a brush or compressed air.
6. Insert the provided four anchors into the holes.
7. Have another person hold the switch at the selected wall location while you secure it to the wall with the four M4x32mm provided screws. Refer to Figure 29 on page 68.

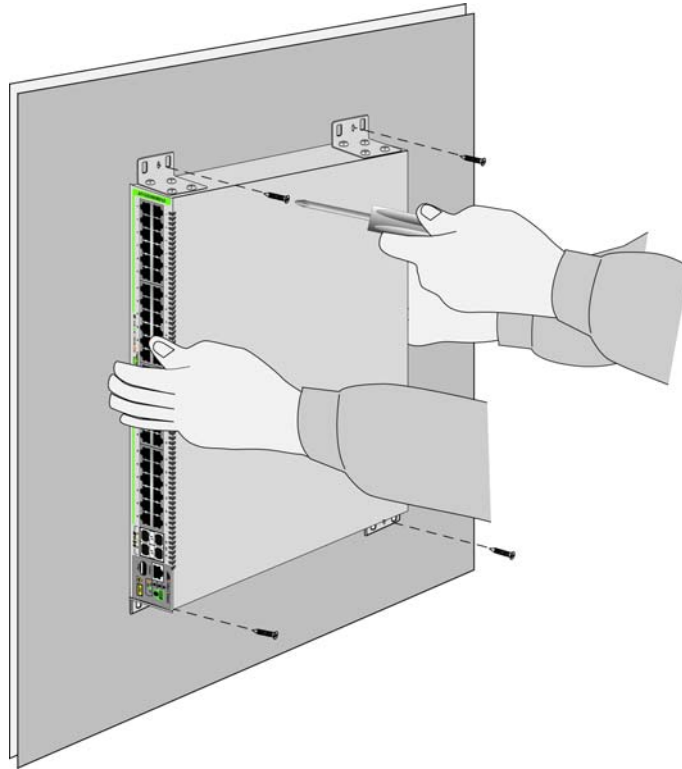

Figure 29. Installing the Switch on a Concrete Wall

8. Go to Chapter 6, “Cabling the Networking Ports and Powering On the Switch” on page 69.

## Chapter 6

# Cabling the Networking Ports and Powering On the Switch

---

This chapter contains the following procedures:

- ❑ “Cabling Twisted Pair Ports” on page 70
- ❑ “Guidelines to Handling SFP Transceivers” on page 71
- ❑ “Installing SFP Transceivers” on page 72
- ❑ “Powering On the Switch” on page 76
- ❑ “Starting a Local Management Session” on page 79
- ❑ “Verifying the Switch with AlliedWare Plus Commands” on page 81

## Cabling Twisted Pair Ports

---

Here are the guidelines to cabling the twisted pair ports:

- ❑ The cable specifications for the ports on the switch are given in “Cable Requirements” on page 22.
- ❑ PoE is enabled by default on the ports on the AT-GS980M/52PS switch.
- ❑ The connectors on the cables should fit snugly into the ports, and the tabs should lock the connectors into place.
- ❑ The default speed setting for the ports is Auto-Negotiation. This setting is appropriate for ports connected to network devices that also support Auto-Negotiation.
- ❑ The ports must be set to Auto-Negotiation, the default setting, to operate at 1000Mbps.
- ❑ The ports support half- and full-duplex at 10Mbps or 100Mbps.
- ❑ The ports support only full-duplex at 1000Mbps.
- ❑ Do not attach cables to ports of static or LACP port trunks until after you configure the trunks on the switch. Otherwise, the ports will form network loops that can adversely affect network performance.

## Guidelines to Handling SFP Transceivers

---

Please review the following guidelines before installing SFP transceivers in the switches:

- ❑ The transceivers are hot-swappable. You can install them while the switch is powered on.
- ❑ For a list of supported transceivers, refer to the product data sheet on the Allied Telesis web site.
- ❑ The operational specifications and fiber optic cable requirements of the transceivers are provided in the documents included with the devices.
- ❑ You should install a transceiver before connecting its fiber optic cable.
- ❑ Fiber optic transceivers are dust sensitive. Always keep the plug in the optical bores when a fiber optic cable is not installed, or when you store the transceiver. When you do remove the plug, keep it for future use.
- ❑ Unnecessary removal and insertion of a transceiver can lead to premature failure.



### **Caution**

Transceivers can be damaged by static electricity. Be sure to observe all standard electrostatic discharge (ESD) precautions, such as wearing an antistatic wrist strap, to avoid damaging the devices. *ES* E92

---

## Installing SFP Transceivers

---

This section contains installation instructions for SFP transceivers. The illustrations show a transceiver with a duplex LC connector. The connectors on your transceivers may be different. Please review “Guidelines to Handling SFP Transceivers” on page 71 before performing this procedure.

To install transceivers, perform the following procedure:

1. Select a port for the transceiver.
2. If the port has a dust cover, remove it. Refer to Figure 30.

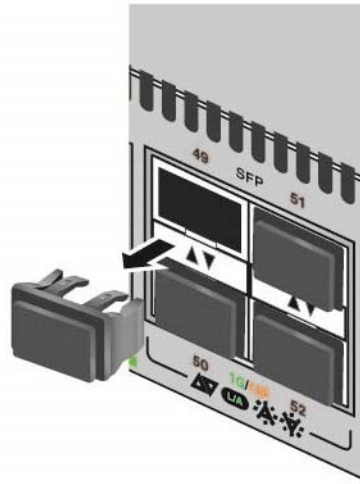

Figure 30. Removing the Dust Plug from an SFP Port

3. Remove the transceiver from its shipping container and store the packaging material in a safe location.
4. If you are installing the transceiver in a top port, position the transceiver with the Allied Telesis label facing up. If you are installing the transceiver in a bottom port, position the transceiver with the label facing down. Refer to Figure 31 on page 73.



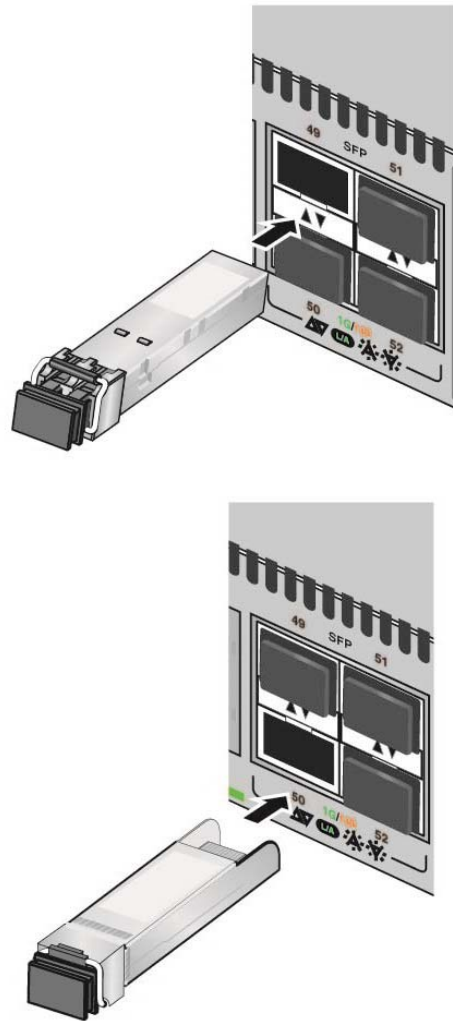

Figure 31. Installing an SFP Transceiver

5. Slide the transceiver into the port until it clicks into place.

---

**Note**

If you are ready to attach the fiber optic cable to the transceiver, continue with the next step. Otherwise, repeat steps 1 to 5 to install the remaining transceivers in the switch.

---

6. Remove the dust cover from the transceiver, as shown in Figure 32 on page 74.

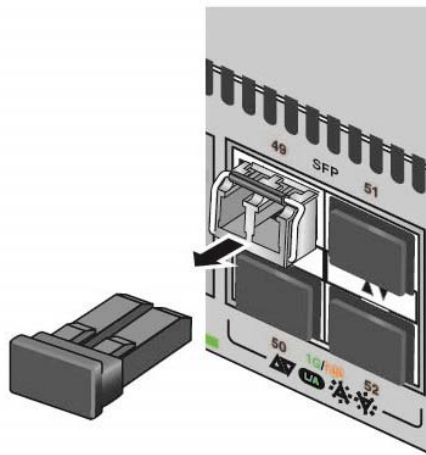

Figure 32. Removing the Dust Cover from an SFP Transceiver

7. Verify the position of the handle on the transceiver. If the transceiver is in a top port, the handle should be in the upright position, as shown in Figure 33. If the transceiver is in a bottom port, the handle should be in the down position.

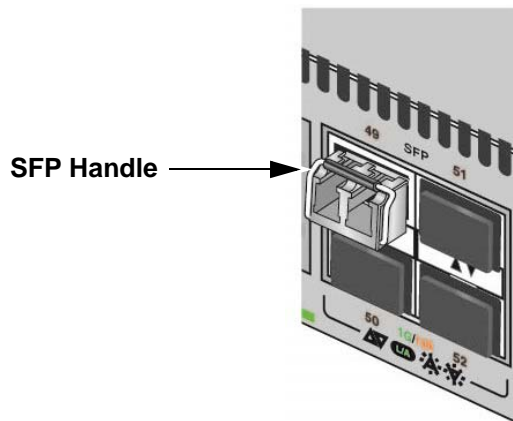

Figure 33. Positioning the SFP Handle in the Upright Position

8. Connect the fiber optic cable to the transceiver, as shown in Figure 34 on page 75. The connector on the cable should fit snugly into the port, and the tab should lock the connector into place.

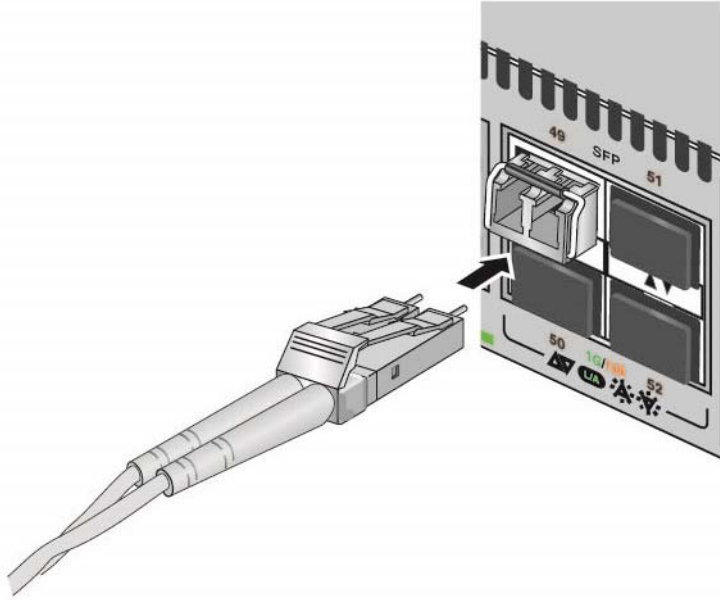

Figure 34. Connecting a Fiber Optic Cable to an SFP Transceiver

9. Repeat this procedure to install additional transceivers.

## Powering On the Switch

---

Before powering on the switch, review the information in “Power Specifications” on page 90 for the power specifications.



---

### Warning

Power cord is used as a disconnection device. To de-energize equipment, disconnect the power cord. ⚡ E3

---

---

### Note

Pluggable Equipment. The socket outlet shall be installed near the equipment and shall be easily accessible. ⚡ E5

---

To power on the switch, perform the following procedure:

1. Install the power cord retaining clip on the AC power connector on the rear panel of the switch, as shown in Figure 35.

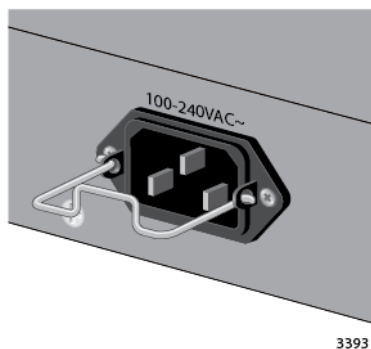
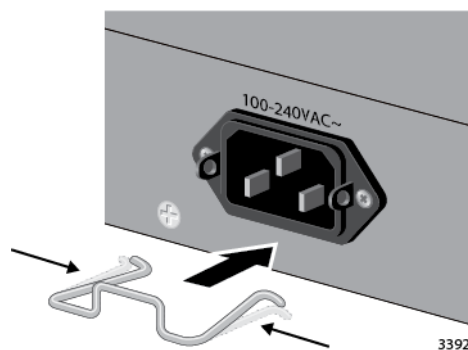

Figure 35. Installing the Power Cord Retaining Clip

2. Connect the AC power cord to the AC power connector on the rear panel. Refer to Figure 36.

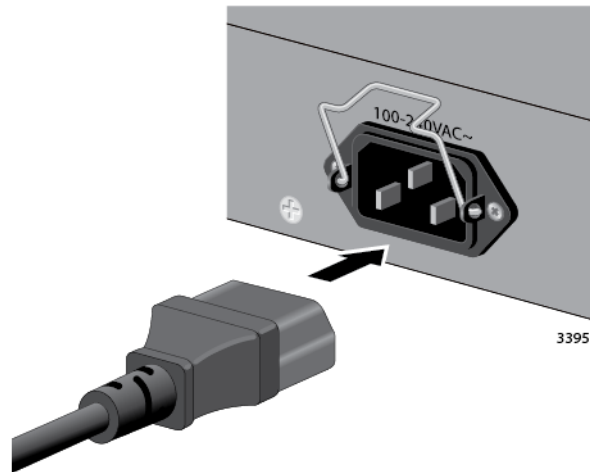
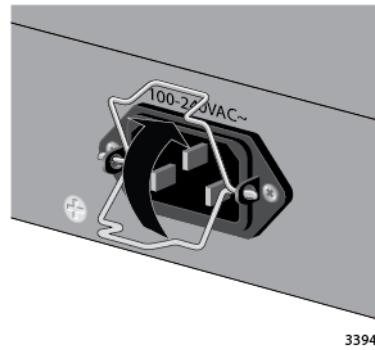

Figure 36. Connecting the AC Power Cord

3. Lower the power cord retaining clip to secure the cord to the switch. Refer to Figure 37.

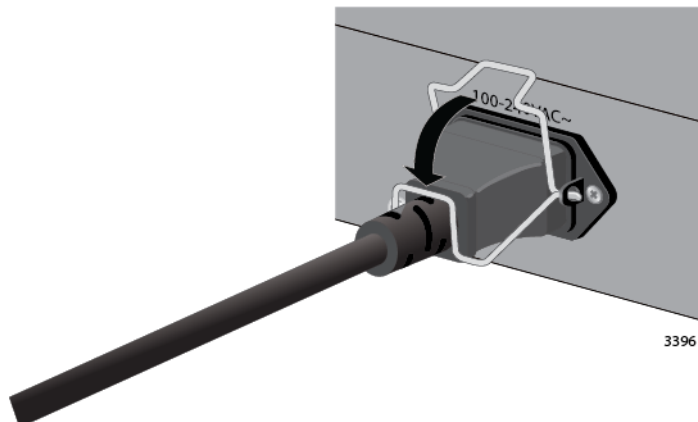

Figure 37. Lowering the Power Cord Retaining Clip

4. Connect the power cord to an appropriate AC power source. Refer to Figure 38.

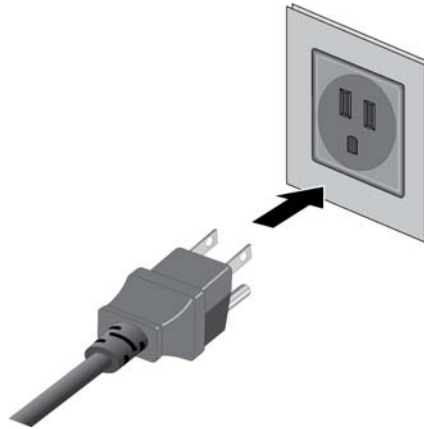

Figure 38. Connecting the Power Cord to an AC Power Source

---

**Note**

The illustration shows a North American power cord. Your power cord may be different.

---

5. Wait two minutes for the switch to initialize the management software.

The installation is complete. The switch is now ready for network operations. To start managing the switch, refer to “Starting a Local Management Session” on page 79.

## Starting a Local Management Session

---

After you have powered on the switch and waited two minutes for it to initialize its management software, start a local management session using the Console port on the management panel, as explained in this section.

---

**Note**

The initial management session must be from the Console port.

---

To start a local management session, perform the following procedure:

1. Connect the RJ-45 end of the management card included with the switch to the Console RS-232 port on the management panel. Refer to Figure 39.

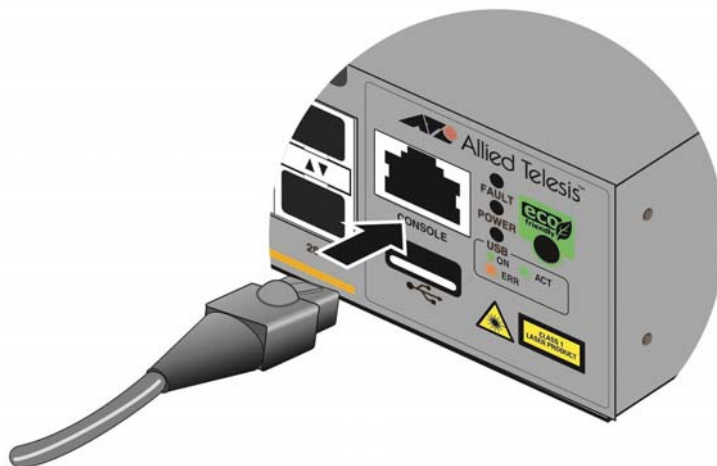

Figure 39. Connecting the Management Cable to the Console RS-232 Port

2. Connect the other end of the cable to an RS-232 port on a terminal or personal computer with a terminal emulation program.
3. Configure the VT-100 terminal or terminal emulation program as follows:
  - Default baud rate: 9600 bps (The baud rates of the Console port are 9600, 19200, 38400, 57600, and 115200 bps.)
  - Data bits: 8
  - Parity: None
  - Stop bits: 1
  - Flow controller: None

---

**Note**

The port settings are for a DEC VT100 or ANSI terminal, or an equivalent terminal emulator program.

---

4. Press Enter. You are prompted for a user name and password.
5. Enter the default user name and password. They are “manager” and “friend” (without quotes), respectively

---

**Note**

User names and passwords are case sensitive.

---

The local management session starts when the User Exec mode prompt, shown in Figure 40, is displayed.



awpl us>

Figure 40. User Exec Mode Prompt

---

**Note**

The User Exec mode is the first level in the command mode interface. For complete information on the modes and commands, refer to the *Software Reference for GS980M Series Switches, AlliedWare Plus Operating System* from [www.alliedtelesis.com](http://www.alliedtelesis.com).

---

6. Go to “Verifying the Switch with AlliedWare Plus Commands” on page 81.



## Verifying the Switch with AlliedWare Plus Commands

---

Now that you have installed the switch and powered it on for the first time, you should verify that the hardware components are operating correctly. The following procedure show how to do this using commands in the AlliedWare Plus operating system. To verify the hardware operations of the switch, perform the following procedure:

1. Start a local management session on the switch. For instructions, refer to “Starting a Local Management Session” on page 79.
2. To display the status of the power supply, enter the `SHOW SYSTEM ENVIRONMENT` command in the User Exec or Privileged Exec mode. The Status column in the display provides the states of the modules. Components are operating normally when they have an “Ok” status.
3. To display the states of the ports, use the `SHOW INTERFACE STATUS` command in the Privileged Exec mode.

For information about the command line interface, refer to the Software Reference for AT-x950 Switches on the Allied Telesis web site.



## Chapter 7

# Troubleshooting

---

This chapter contains suggestions on how to troubleshoot problems with the switch.

---

**Note**

For further assistance, please contact Allied Telesis Technical Support at [www.alliedtelesis.com/support](http://www.alliedtelesis.com/support).

---

**Problem 1:** All port and system LEDs are off, and the fan is not operating.

**Solutions:** The unit is not receiving power. Try the following:

- Verify that the power cord is securely connected to the power source and the AC connector on the back panel of the switch.
- Verify that the power outlet has power by connecting another device to it.
- Try connecting the unit to another power source.
- Try a different power cord.
- Verify that the voltage from the power source is within the required levels for your region. The power requirements for the switch are listed in “Power Specifications” on page 90.

**Problem 2:** All of the port LEDs are off even though the ports are connected to active network devices.

**Solution:** The switch might be operating in the low power mode. To toggle on the LEDs, press the eco-friendly button on the front panel of the switch. You can also toggle the LEDs off and on with the ECOFRIENDLY LED and NO ECOFRIENDLY LED commands in the command line interface.

**Problem 3:** A LINK/ACT LED is off for a twisted pair port that is connected to an active network device.

**Solutions:** The port is unable to establish a link to a network device. Try the following:

- Verify that the network device connected to the twisted pair port is powered on and is operating properly.
- Verify that the twisted pair cable does not exceed 100 meters (328 feet).

- ❑ Try connecting another network device to the twisted pair port with a different cable. If the twisted pair port is able to establish a link, then the problem is with the cable or the other network device.
- ❑ Verify that you are using the appropriate category of twisted pair cable. Refer to “Cable Requirements” on page 22.
- ❑ Verify that the port is connected to the correct twisted pair cable.

---

**Note**

Twisted pair ports may require five to ten seconds to establish a link.

---

**Problem 4:** The LINK/ACT LED is off for an SFP transceiver that is connected to an active network device.

**Solutions:** The fiber optic port on the transceiver is unable to establish a link to a network device. Try the following:

- ❑ Verify that the remote network device is operating properly.
- ❑ Verify that the fiber optic cable is securely connected to the port on the transceiver and to the port on the remote network device.
- ❑ Check that the transceiver is fully inserted in the slot.
- ❑ Verify that the operating specifications of the fiber optic ports on the transceiver and remote network device are compatible.
- ❑ Verify that the correct type of fiber optic cabling is being used.
- ❑ Verify that the port is connected to the correct fiber optic cable.
- ❑ Try connecting another network device to the fiber optic port using a different cable. If the port is able to establish a link, then the problem is with the cable or with the other network device.
- ❑ Use the management software to verify that the port is enabled.
- ❑ If the remote network device is a managed device, use its management firmware to determine whether its port is enabled.
- ❑ If two BiDi (bi-directional) transceivers cannot establish a link, refer to their data sheets to verify that their transmission and reception frequencies are opposite to each other. For instance, a BiDi transceiver that transmits and receives at 1310nm and 1550nm, respectively, has to be connected to a transceiver that transmits and receives at 1550nm and 1310nm, respectively. Two BiDi transceivers cannot establish a link if they transmit and receive at the same frequencies.
- ❑ Test the attenuation of both directions on the fiber optic cable with a fiber optic tester to determine whether the optical signal is too weak (sensitivity) or too strong (maximum input power).

**Problem 5:** The AT-GS980M/52PS Switch is not providing power to any powered devices or to only a few devices whose power requirements are

below the power budget of 740W.

**Solution:** The power supply in the switch may have a problem. Start a management session and use the `SHOW SYSTEM ENVIRONMENT` command in the management software to determine the status of the power supply.

**Problem 6:** A port on the AT-GS980M/52PS Switch is not providing power to a PoE or PoE+ device.

**Solutions:** Try the following:

- ❑ Check the port's PoE LED. Refer to Figure 5 on page 24 and Table 3 on page 25. If the LED is flashing amber, the switch cannot support additional PoE devices because it is already providing its maximum power to other devices. The maximum power budget for the switch is 740W.
- ❑ Review the PD's documentation to confirm that the device supports Mode A of the IEEE 802.3at standard and that it uses pins 1, 2, 3, and 6 on the RJ-45 port to receive power. Refer to "Wiring Implementation" on page 28.
- ❑ Check that the device's power requirements do not exceed 30W by reviewing its documentation or data sheet.
- ❑ Verify that you are using the appropriate category of twisted-pair cable. Refer to "Cable Requirements" on page 22.
- ❑ Use the management software on the switch to determine whether PoE is enabled on the port. The default setting for PoE is enabled.
- ❑ Use the management software on the switch to determine whether the PoE power setting for the port has been reduced to a value below the power requirements of the device.
- ❑ Try connecting the device to a different port on the switch.

**Problem 7:** The switch functions intermittently.

**Solutions:** Check the system hardware status through the management software:

- ❑ Use the `SHOW SYSTEM ENVIRONMENT` command in the Privileged Exec mode to verify that the input voltage from the power source to the switch is stable and within the approved operating range. The unit will shut down if the input voltage fluctuates above or below the approved operating range.
- ❑ Use the `SHOW SYSTEM ENVIRONMENT` command in the Privileged Exec mode to verify that the fan is operating correctly.
- ❑ Verify that the location of the switch allows for adequate airflow. The unit will shut down if it overheats.



## Appendix A

# Technical Specifications

---

This appendix contains the following sections:

- "Physical Specifications" on page 88
- "Environmental Specifications" on page 89
- "Power Specifications" on page 90
- "Certificates" on page 91
- "RJ-45 Twisted Pair Port Pinouts" on page 92
- "RJ-45 Style Serial Console Port Pinouts" on page 94

## Physical Specifications

---

### Dimensions (H x W x D)

Table 9 lists the dimensions of the switches.

Table 9. Product Dimensions

AT-GS980M/52	4.4 cm x 44.1 cm x 32.3 cm (1.7 in. x 17.3 in. x 12.7 in.)
AT-GS980M/52PS	4.4 cm x 44.1 cm x 35.9 cm (1.7 in. x 17.3 in. x 14.1 in.)

### Weights

Table 10 lists the weights of the switches.

Table 10. Product Weights

AT-GS980M/52	4.5 kg (9.9 lb.)
AT-GS980M/52PS	5.8 kg (12.8 lb.)

### Ventilation

Table 11 lists the ventilation requirements.

Table 11. Ventilation Requirements

Recommended Minimum Ventilation on All Sides	10 cm (4.0 in)
----------------------------------------------	----------------



## Environmental Specifications

---

Table 12 lists the environmental specifications of the switches.

Table 12. Environmental Specifications

Operating Temperature	0° C to 50° C (32° F to 122° F)
Storage Temperature	-25° C to 70° C (-13° F to 158° F)
Operating Humidity	5% to 90% noncondensing
Storage Humidity	5% to 95% noncondensing
Maximum Operating Altitude	3,000 m (9,842 ft)
Maximum Nonoperating Altitude	4,000 m (13,100 ft)

## Power Specifications

---

This section contains the maximum power consumption values, input voltages, and heat dissipation values.

### Maximum Power Consumption

Table 13 lists the maximum power consumptions for the switches.

Table 13. Maximum Power Consumptions

AT-GS980M/52	48 watts
AT-GS980M/52PS	946 watts

### Input Voltages

Table 14 lists the input voltages for the switches.

Table 14. Input Voltages

AT-GS980M/52	100-240 VAC~, 1.0A maximum, 50/60 Hz
AT-GS980M/52PS	100-240 VAC~, 12-6A maximum, 50/60 Hz

### Heat Dissipations

Table 15 lists the heat dissipations for the switches.

Table 15. Heat Dissipations

AT-GS980M/52	164 BTU/hr
AT-GS980M/52PS	3,230 BTU/hr

## Certificates

---

Table 16 lists the product certificates.

Table 16. Product Certificates

Category	Certificates
EMC	EN 55024 EN 55032 Class A EN 61000-3-2 EN 61000-3-3 FCC Part 15 (CFR 47) Class A VCCI Class A CISPR 22 Class A ICES-003
Environmental Compliance	RoHS WEEE
Electrical Safety	EN 60950-1 (second edition) CAN/CSA-C22.2 No. 60950-1-07 (second edition) UL 60950-1 (second edition) cULus Mark TUV-T-Mark
Regulatory Compliance	RCM CE



Laser Safety

EN60825

## RJ-45 Twisted Pair Port Pinouts

Figure 41 illustrates the pin layout of the RJ-45 twisted pair ports on the AT-GS980M/52 and AT-GS980M/52PS Switches.

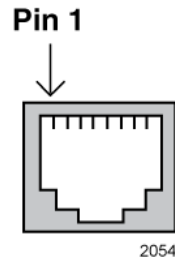

Figure 41. Pin Layout for the RJ-45 Twisted Pair Ports (Front View)

Table 17 lists the pin signals at 100Mbps.

Table 17. Pin Signals on the RJ-45 Twisted Pair Ports at 10 or 100Mbps

Pin	MDI Signal	MDI-X Signal
1	TX+	RX+
2	TX-	RX-
3	RX+	TX+
4	Not used	Not used
5	Not used	Not used
6	RX-	TX-
7	Not used	Not used
8	Not used	Not used

Table 18 lists the pin signals at 1Gbps

Table 18. Pin Signals on the RJ-45 Twisted Pair Ports at 1Gbps

Pinout	Pair
1	Pair 1 +
2	Pair 1 -
3	Pair 2 +

Table 18. Pin Signals on the RJ-45 Twisted Pair Ports at 1Gbps

4	Pair 3 +
5	Pair 3 -
6	Pair 2 -
7	Pair 4 +
8	Pair 4 -

## RJ-45 Style Serial Console Port Pinouts

---

Table 19 lists the pin signals of the RJ-45 style serial Console port.

Table 19. Pin Signals of the RJ-45 Style Serial Console Port

<b>Pin</b>	<b>Signal</b>
1	Looped to pin 8.
2	Looped to pin 7.
3	Transmit Data
4	Ground
5	Ground
6	Receive Data
7	Looped to pin 2.
8	Looped to pin 1.