

Operating Instructions Functional Manual

LCD Projector Commercial Use

Model No. **PT-VW360**
PT-VX430

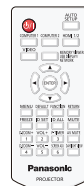
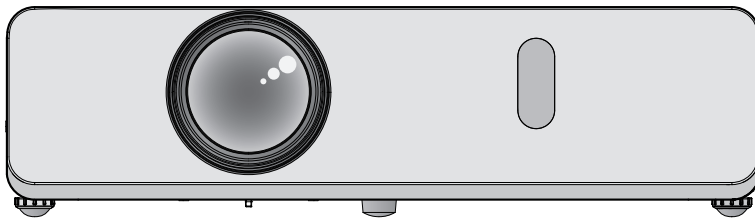

Thank you for purchasing this Panasonic product.

- This manual is intended for products manufactured from Aug. 2018 and beyond.
- Before operating this product, please read the instructions carefully, and save this manual for future use.
- Before using your projector, be sure to read “Read this first!” (➔ pages 4 to 12).

Contents

Read this first! 4

Chapter 1 Preparation

Precautions for use	16
Cautions when transporting.....	16
Cautions when installing.....	16
Security	18
Notes on using wireless connection	18
Application software supported by the projector ..	19
Storage.....	20
Disposal.....	20
Cautions on use	20
Accessories	21
Optional accessories	22
About your projector	23
Remote control	23
Projector body	24
Preparing the remote control	27
Inserting and removing batteries	27
When using the system with multiple projectors ..	27
Attaching the lens cap	28

Chapter 2 Getting Started

Setting up	30
Installation mode	30
Parts for ceiling mount (optional).....	31
Screen size and throw distance	31
Connecting	34
Before connecting	34
Connecting example : AV equipment	35
Connecting example : Computers	36

Chapter 3 Basic Operations

Powering on/off	38
Connecting the power cord	38
Power indicator.....	38
Powering on the projector	39
When the initial setting screen is displayed.....	40
Making adjustments and selections	41
Powering off the projector	42
Direct Power Off function	42
Projecting	43
Selecting the input signal	43
How to adjust the state of the image	44
Adjusting adjustable feet	45
Basic operations by using the remote control	46
Using the AV mute function	46
Using the mute function.....	46
Controlling the volume of the speaker.....	46
Using the freeze function.....	46

Using the auto setup function.....	47
Using the screen adjustment function	47
Using the digital zoom function	48
Using the presentation timer function.....	48
Using the FUNCTION button.....	49
Using the Daylight View function	49
Setting the ID number of the remote control	49

Chapter 4 Settings

Menu navigation	52
Navigating through the menu	52
Main menu.....	53
Sub-menu.....	54
[PICTURE] menu	56
[PICTURE MODE].....	56
[CONTRAST].....	56
[BRIGHTNESS]	56
[COLOR].....	56
[TINT]	57
[SHARPNESS]	57
[COLOR TEMPERATURE].....	57
[IRIS]	57
[ADVANCED MENU]	58
[DAYLIGHT VIEW].....	58
[DIGITAL CINEMA REALITY]	59
[NOISE REDUCTION].....	59
[TV-SYSTEM]	59
[RGB/Y _B P _R] / [RGB/Y _B C _R]	59
[POSITION] menu	61
[REALTIME KEYSTONE]	61
[SCREEN ADJUSTMENT]	61
[SHIFT]	63
[DOT CLOCK].....	64
[CLOCK PHASE].....	64
[OVER SCAN]	65
[ASPECT]	65
[FRAME LOCK]	66
[LANGUAGE] menu	67
Changing the display language	67
[DISPLAY OPTION] menu	68
[ON-SCREEN DISPLAY].....	68
[HDMI SIGNAL LEVEL].....	69
[CLOSED CAPTION SETTING] (Only for NTSC, 480i YC _B C _R input)	69
[SCREEN SETTING]	70
[STARTUP LOGO].....	70
[AUTO SETUP SETTING].....	71
[SIGNAL SEARCH]	71
[BACK COLOR].....	71
[WIDE MODE]	71
[SXGA MODE].....	71
[P-TIMER].....	72

[OTHER FUNCTIONS]	73
[PROJECTOR SETUP] menu	74
[STATUS]	74
[COMPUTER1 INPUT SETTING]	74
[COMPUTER2 SELECT]	74
[PROJECTOR ID]	75
[INITIAL START UP]	75
[PROJECTION METHOD]	75
[HIGH ALTITUDE MODE]	75
[LAMP POWER]	76
[ECO MANAGEMENT]	76
[EMULATE]	78
[FUNCTION BUTTON]	78
[AUDIO SETTING]	78
[TEST PATTERN]	80
[FILTER COUNTER]	80
[INITIALIZE ALL]	81
[SECURITY] menu	82
[PASSWORD]	82
[PASSWORD CHANGE]	82
[TEXT DISPLAY]	82
[TEXT CHANGE]	83
[MENU LOCK]	83
[MENU LOCK PASSWORD]	83
[CONTROL DEVICE SETUP]	83
[NETWORK/USB] menu	85
[WIRED LAN]	85
[NAME CHANGE]	85
[NETWORK CONTROL]	86
[AMX D.D.]	86
[Crestron Connected(TM)]	86
[MEMORY VIEWER LIGHT]	86
[STATUS]	88
[INITIALIZE]	88

Chapter 5 Operation of Function

Memory Viewer function	90
Images that can be played back with the Memory Viewer function	90
Cautions on using USB Memory	90
Displaying the Memory Viewer screen	91
Playing the pictures	91
Executing the slide	91
Termination of the Memory Viewer	91
USB display function	92
When using on a Windows computer	92
When using Mac	93
Network connection	94
Connecting with wired LAN	94
Connecting with wireless LAN	95
About Presenter Light	97
Web control function	99
Computer that can be used	99
Accessing from the web browser	99

Chapter 6 Maintenance

Lamp and Warning Indicators	115
When an indicator lights up	115
Maintenance/replacement	116
Before performing maintenance/replacement	116
Maintenance	116
Replacing the unit	116
Troubleshooting	120

Chapter 7 Appendix

Technical Information	122
PJLink protocol	122
Control commands via LAN	123
<SERIAL IN> terminal	125
[MENU LOCK PASSWORD] operations	127
List of compatible signals	128
Specifications	130
Dimensions	133
Ceiling mount bracket safeguards	134
Index	135

Read this first!

WARNING: THIS APPARATUS MUST BE EARTHED.

WARNING: To prevent damage which may result in fire or shock hazard, do not expose this appliance to rain or moisture.
This device is not intended for use in the direct field of view at visual display workplaces. To avoid incommoding reflexions at visual display workplaces this device must not be placed in the direct field of view.
The equipment is not intended for used at a video workstation in compliance BildscharbV.
The sound pressure level at the operator position is equal or less than 70 dB (A) according to ISO 7779.

WARNING:

1. Remove the plug from the mains socket when this unit is not in use for a prolonged period of time.
2. To prevent electric shock, do not remove cover. No user serviceable parts inside. Refer servicing to qualified service personnel.
3. Do not remove the earthing pin on the mains plug. This apparatus is equipped with a three prong earthing type mains plug. This plug will only fit an earthing-type mains socket. This is a safety feature. If you are unable to insert the plug into the mains socket, contact an electrician. Do not defeat the purpose of the earthing plug.

WARNING: TO REDUCE THE RISK OF FIRE OR ELECTRIC SHOCK, DO NOT EXPOSE THIS PRODUCT TO RAIN OR MOISTURE.

WARNING: RISK OF ELECTRIC SHOCK. DON'T OPEN.



Indicated on the projector



The lightning flash with arrowhead symbol, within an equilateral triangle, is intended to alert the user to the presence of uninsulated “dangerous voltage” within the product’s enclosure that may be of sufficient magnitude to constitute a risk of electric shock to persons.



The exclamation point within an equilateral triangle is intended to alert the user to the presence of important operating and maintenance (servicing) instructions in the literature accompanying the product.

WARNING:



TURN THE POWER OFF AND DISCONNECT THE POWER PLUG FROM THE WALL OUTLET BEFORE REPLACING THE LAMP UNIT.

WARNING: Do not look at the light emitted from the lens while the projector is being used.

WARNING:DO NOT LOOK INTO THE LENS.
AVERTISSEMENT:NE PAS REGARDER À TRAVERS LA LENTILLE.
WARNUNG:NICHT IN DIE LINSE SEHEN.
ПРЕДУПРЕЖДЕНИЕ:НЕ СМОТРЕТЬ НА ОБЪЕКТИВ.
경고:사용 중에 렌즈를 들여다 보지 마십시오.

Indicated on the projector

WARNING: Do not place objects in front of the lens while the projector is being used.

Read this first!

CAUTION: To assure continued compliance, follow the attached installation instructions. This includes using the provided power cord and shielded interface cables when connecting to computer or peripheral devices. Also, any unauthorized changes or modifications to this equipment could void the user's authority to operate this device.

This is a device to project images onto a screen, etc., and is not intended for use as indoor lighting in a domestic environment.

Directive 2009/125/EC

Importer's name and address within the European Union

Panasonic Marketing Europe GmbH
Panasonic Testing Centre
Winsbergring 15, 22525 Hamburg, Germany

CAUTION (North/Middle/South America)

This equipment is equipped with a three-pin grounding-type power plug. Do not remove the grounding pin on the power plug. This plug will only fit a grounding-type power outlet. This is a safety feature. If you are unable to insert the plug into the outlet, contact an electrician. Do not defeat the purpose of the grounding plug.

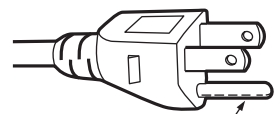

Do not remove

FCC NOTICE (USA)

Declaration of Conformity

Model Number: PT-VW360, PT-VX430
Trade Name: Panasonic
Responsible Party: Panasonic Corporation of North America
Address: Two Riverfront Plaza, Newark, NJ 07102-5490
General Contact: <http://www.panasonic.com/support>
Projector Contact: <https://panasonic.net/cns/projector/>

This device complies with Part 15 of the FCC Rules.

Operation is subject to the following two conditions:

(1) This device may not cause harmful interference, and (2) this device must accept any interference received, including interference that may cause undesired operation.

To assure continued compliance, follow the attached installation instructions and do not make any unauthorized modifications.

CAUTION:

This equipment has been tested and found to comply with the limits for a Class B digital device, pursuant to Part 15 of the FCC Rules. These limits are designed to provide reasonable protection against harmful interference in a residential installation. This equipment generates, uses and can radiate radio frequency energy and, if not installed and used in accordance with the instructions, may cause harmful interference to radio communications. However, there is no guarantee that interference will not occur in a particular installation. If this equipment does cause harmful interference to radio or television reception, which can be determined by turning the equipment off and on, the user is encouraged to try to correct the interference by one of the following measures:

- Reorient or relocate the receiving antenna.
- Increase the separation between the equipment and receiver.
- Connect the equipment into an outlet on a circuit different from that to which the receiver is connected.
- Consult the dealer or an experienced radio/BD technician for help.

The user may find the booklet "Something About Interference" available from FCC local regional offices helpful.

FCC Warning:

To assure continued FCC emission limit compliance, follow the attached installation instructions. This includes using the provided power cord and shielded interface cables when connecting to computer or peripheral devices. Also, any unauthorized changes or modifications to this equipment could void the user's authority to operate this device.

WARNING (USA and Canada)

- Not for use in a computer room as defined in the Standard for the Protection of Electronic Computer/Data Processing Equipment, ANSI/NFPA 75.
- For permanently connected equipment, a readily accessible disconnect device shall be incorporated in the building installation wiring.
- For pluggable equipment, the socket-outlet shall be installed near the equipment and shall be easily accessible.

NOTIFICATION (Canada)

This class B digital apparatus complies with Canadian ICES-003.

Contains mercury / Contenu avec mercure

For more information on safe handling procedures, the measures to be taken in case of accidental breakage and safe disposal options visit:

ec.gc.ca/mercure-mercury/.

Dispose of or recycle in accordance with applicable laws.

Pour plus de renseignements sur les procédures de manutention sécuritaire, les mesures à prendre en cas de bris accidentel et les options d'élimination sécuritaire visitez:

ec.gc.ca/mercure-mercury/.

Mettez au rebut ou recyclez conformément aux lois applicables.

NOTIFICATION (USA)

- This product has a High Intensity Discharge (HID) lamp that contains mercury. Disposal may be regulated in your community due to environmental considerations. For disposal or recycling information, please visit Panasonic website: <http://www.panasonic.com/environmental> or call 1-888-769-0149.

IMPORTANT: THE MOULDED PLUG

FOR YOUR SAFETY, PLEASE READ THE FOLLOWING TEXT CAREFULLY.

This appliance is supplied with a moulded three pin mains plug for your safety and convenience. A 13 amp fuse is fitted in this plug. Should the fuse need to be replaced, please ensure that the replacement fuse has a rating of 13 amps and that it is approved by ASTA or BSI to BS1362.

Check for the ASTA mark  or the BSI mark  on the body of the fuse.

If the plug contains a removable fuse cover, you must ensure that it is refitted when the fuse is replaced. If you lose the fuse cover, the plug must not be used until a replacement cover is obtained. A replacement fuse cover can be purchased from an Authorised Service Center.

If the fitted moulded plug is unsuitable for the mains socket in your home, then the fuse should be removed and the plug cut off and disposed of safely. There is a danger of severe electrical shock if the cut off plug is inserted into any 13 amp socket.

If a new plug is to be fitted, please observe the wiring code as shown below.

If in any doubt, please consult a qualified electrician.

WARNING: THIS APPLIANCE MUST BE EARTHED.

IMPORTANT: The wires in this mains lead are coloured in accordance with the following code:

Green - and - Yellow:	Earth
Blue:	Neutral
Brown:	Live

As the colours of the wire in the mains lead of this appliance may not correspond with the coloured markings identifying the terminals in your plug, proceed as follows.

The wire which is coloured GREEN - AND - YELLOW must be connected to the terminal in the plug which is marked with the letter E or by the Earth symbol  or coloured GREEN or GREEN - AND - YELLOW.

The wire which is coloured BLUE must be connected to the terminal in the plug which is marked with the letter N or coloured BLACK.

The wire which is coloured BROWN must be connected to the terminal in the plug which is marked with the letter L or coloured RED.

How to replace the fuse: Open the fuse compartment with a screwdriver and replace the fuse.

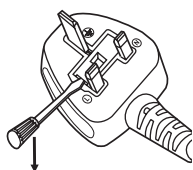

WARNING:

■ POWER

The wall outlet or the circuit breaker shall be installed near the equipment and shall be easily accessible when problems occur. If the following problems occur, cut off the power supply immediately.

Continued use of the projector in these conditions will result in fire or electric shock.

- If foreign objects or water get inside the projector, cut off the power supply.
- If the projector is dropped or the cabinet is broken, cut off the power supply.
- If you notice smoke, strange smells or noise coming from the projector, cut off the power supply.

Please contact an Authorized Service Center for repairs, and do not attempt to repair the projector yourself.

During a thunderstorm, do not touch the projector or the cable.

Electric shocks can result.

Do not do anything that might damage the power cord or the power plug.

If the power cord is used while damaged, electric shocks, short-circuits or fire will result.

- Do not damage the power cord, make any modifications to it, place it near any hot objects, bend it excessively, twist it, pull it, place heavy objects on top of it or wrap it into a bundle.

Ask an Authorized Service Center to carry out any repairs to the power cord that might be necessary.

Completely insert the power plug into the wall outlet and the power connector into the projector terminal.

If the plug is not inserted correctly, electric shocks or overheating will result.

- Do not use plugs which are damaged or wall outlets which are coming loose from the wall.

Do not use anything other than the provided power cord.

Failure to observe this will result in fire or electric shocks. Please note that if you do not use the provided power cord to ground the device on the side of the outlet, this may result in electric shocks.

Clean the power plug regularly to prevent it from becoming covered in dust.

Failure to observe this will cause a fire.

- If dust builds up on the power plug, the resulting humidity can damage the insulation.
- If not using the projector for an extended period of time, pull the power plug out from the wall outlet.

Pull the power plug out from the wall outlet and wipe it with a dry cloth regularly.

Do not handle the power plug and power connector with wet hands.

Failure to observe this will result in electric shocks.

Do not overload the wall outlet.

If the power supply is overloaded (ex., by using too many adapters), overheating may occur and fire will result.

■ ON USE/INSTALLATION

Do not place the projector on soft materials such as carpets or sponge mats.

Doing so will cause the projector to overheat, which can cause burns, fire or damage to the projector.

Do not set up the projector in humid or dusty places or in places where the projector may come into contact with oily smoke or steam.

Using the projector under such conditions will result in fire, electric shocks or deterioration of components. Oil may also distort the plastic and the projector could fall such as when mounted on the ceiling.

Do not install this projector in a place which is not strong enough to take the full weight of the projector or on top of a surface which is sloped or unstable.

Failure to observe this will cause projector to fall down or tip over the projector, and severe injury or damage could result.

Installation work (such as ceiling mount bracket) should only be carried out by a qualified technician.

If installation is not carried out and secured correctly, it can cause injury or accidents, such as electric shocks.

- Be sure to use the wire provided with the ceiling mount bracket as an extra safety measure to prevent the projector from falling down. (Install in a different location to the ceiling mount bracket.)

Do not install the projector in a location where people pass through.

People may bump into the projector or trip on the power cord, which may result in fire, electric shock, or injury.

Do not cover the air intake/exhaust ports.

Doing so will cause the projector to overheat, which can cause fire or damage to the projector.

- Do not place the projector in narrow, badly ventilated places.
- Do not place the projector on cloth or papers, as these materials could be drawn into the air intake port.
- Provide at least 1 m (39-3/8") of space between any walls or objects and the exhaust port, and at least 50 cm (19-11/16") of space between any walls or objects and the intake port.

WARNING:

Do not place your hands or other objects close to the air exhaust port.

Doing so will cause burns or damage your hands or other objects.

- Heated air comes out of the air exhaust port. Do not place your hands or face, or objects which cannot withstand heat close to this port.

Do not look at or place your skin into the lights emitted from the lens while the projector is being used.

Doing so can cause burns or loss of sight.

- Strong light is emitted from the projector's lens. Do not look at or place your hands directly into this light.
- Be especially careful not to let young children look into the lens. In addition, turn off the power and disconnect the power plug when you are away from the projector.

Never attempt to remodel or disassemble the projector.

High voltages can cause fire or electric shocks.

- For any inspection, adjustment and repair work, please contact an Authorized Service Center.

Do not allow metal objects, flammable objects, or liquids to enter inside of the projector. Do not allow the projector to get wet.

Doing so may cause short circuits or overheating, and result in fire, electric shock, or malfunction of the projector.

- Do not place containers of liquid or metal objects near the projector.
- If liquid enters inside of the projector, consult your dealer.
- Particular attention must be paid to children.

Use the ceiling mount bracket specified by Panasonic.

Using the ceiling mount bracket other than the specified one will result in falling accidents.

- Attach the supplied safety cable to the ceiling mount bracket to prevent the projector from falling down.

■ ACCESSORIES

Do not use or handle the batteries improperly, and refer to the following.

Failure to observe this will cause burns, batteries to leak, overheat, explode or catch fire.

- Do not use unspecified batteries.
- Do not charge dry cell batteries.
- Do not disassemble dry cell batteries.
- Do not heat the batteries or place them into water or fire.
- Do not allow the + and - terminals of the batteries to come into contact with metallic objects such as necklaces or hairpins.
- Do not store or carry batteries together with metallic objects.
- Store the batteries in a plastic bag and keep them away from metallic objects.
- Make sure the polarities (+ and -) are correct when inserting the batteries.
- Do not use a new battery together with an old battery or mix different types of batteries.
- Do not use batteries with the outer cover peeling away or removed.

Do not allow children to reach the batteries.

Accidentally swallowing them can cause physical harm.

- If swallowed, seek medical advice immediately.

If the battery fluid leaks, do not touch it with bare hands, and take the following measures if necessary.

- Battery fluid on your skin or clothing could result in skin inflammation or injury.
Rinse with clean water and seek medical advice immediately.
- Battery fluid coming in contact with your eyes could result in loss of sight.
In this case, do not rub your eyes. Rinse with clean water and seek medical advice immediately.

Do not remove unspecified screws during the lamp unit replacement.

Doing so can cause electric shocks, burns, or injury.

Do not disassemble the lamp unit.

If the lamp breaks, it could cause injury.

Lamp replacement

The lamp has high internal pressure. If improperly handled, an explosion and severe injury or accidents will result.

- The lamp can easily explode if struck against hard objects or dropped.
- Before replacing the lamp unit, be sure to turn the power off and to disconnect the power plug from the wall outlet.
Electric shocks or explosions can result if this is not done.
- When replacing the lamp unit, turn the power off and allow the lamp to cool for at least one hour before handling it otherwise it can cause burns.

Remove the depleted batteries from the remote control promptly.

- Leaving them in the unit may result in fluid leakage, overheating, or explosion of the batteries.

CAUTION:

■ POWER

When disconnecting the power cord, be sure to hold the power plug and power connector.

If the power cord itself is pulled, the lead will become damaged, and fire, short-circuits or serious electric shocks will result.

When not using the projector for an extended period of time, disconnect the power plug from the wall outlet.

Failure to do so may result in fire or electric shock.

Disconnect the power plug from the wall outlet before carrying out any cleaning and replacing the unit.

Failure to do so may result in electric shock.

■ ON USE/INSTALLATION

Do not place heavy objects on top of the projector.

Failure to observe this will cause the projector to become unbalanced and fall, which could result in damage or injury. The projector will be damaged or deformed.

Do not put your weight on this projector.

You could fall or the projector could break, and injury will result.

- Be especially careful not to let young children stand or sit on the projector.

Do not place the projector in extremely hot locations.

Doing so will cause the outer casing or internal components to deteriorate, or result in fire.

- Take particular care in locations exposed to direct sunlight or near heaters.

Do not install the projector in a location where salt pollution or corrosive gas may occur.

Doing so may result in falling due to corrosion. Also, it may result in malfunctions.

Do not place objects in front of the lens while the projector is being used.

Do not block the projection by placing an object in front of the projection lens.

Doing so can cause fire, damage to an object, or malfunction of the projector.

- Strong light is emitted from the projector's lens.

Do not stand in front of the lens while the projector is being used.

Doing so can cause damage and burns to clothing.

- Strong light is emitted from the projector's lens.

Always disconnect all cables before moving the projector.

Moving the projector with cables still attached can damage the cables, which will cause fire or electric shocks to occur.

When mounting the projector on the ceiling, keep mounting screws and power cord from contact with metal parts inside the ceiling.

Contact with metal parts inside the ceiling can cause electric shocks.

Never plug headphones and earphones into <VARIABLE AUDIO OUT> terminal.

Excessive sound pressure from earphones and headphones can cause hearing loss.

Do not project an image with the lens cap attached.

Doing so can cause fire.

■ ACCESSORIES

Do not use the old lamp unit.

If used it could cause lamp explosion.

If the lamp has broken, ventilate the room immediately. Do not touch or bring your face close to the broken pieces.

Failure to observe this will cause the user to absorb the gas which was released when the lamp broke and which contains nearly the same amount of mercury as fluorescent lamp, and the broken pieces will cause injury.

- If you believe that you have absorbed the gas or that the gas has got into your eyes or mouth, seek medical advice immediately.
- Ask your dealer about replacing the lamp unit and check the inside of the projector.

CAUTION:

When not using the projector for an extended period of time, remove the batteries from the remote control.

Failure to observe this will cause the batteries to leak, overheat, catch fire or explode, which may result in fire or contamination of surrounding area.

Do not open the desiccant bag, or do not eat the contents.

If swallowed the contents of the desiccant bag accidentally, it may cause bad result to your body.

- If the desiccant gets into your eyes or mouth, immediately rinse with clean water and seek medical advice.
- Be especially careful not to let children reach the desiccant.

■ MAINTENANCE

Ask your dealer about cleaning inside the projector once a year.

Continuous use while dust is accumulated inside the projector may result in fire.

- For cleaning fee, ask your dealer.

To remove the battery

1. Press the guide and lift the cover.

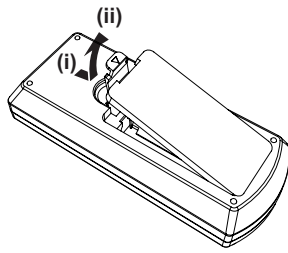

2. Remove the batteries.

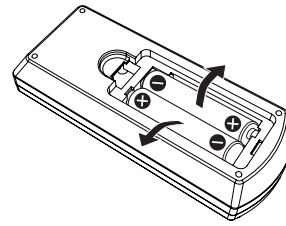

Brazil Only Brasil Apenas

■ Manuseio de baterias usadas

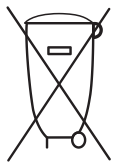

BRASIL

Após o uso, as pilhas e /ou baterias deverão ser entregues ao estabelecimento comercial ou rede de assistência técnica autorizada.

Cobrir os terminais positivo (+) e negativo (-) com uma fita isolante adesiva, antes de depositar numa caixa destinada para o recolhimento. O contato entre partes metálicas pode causar vazamentos, gerar calor, romper a blindagem e produzir fogo. (Fig. 1)

Fig. 1
Como isolar os terminais

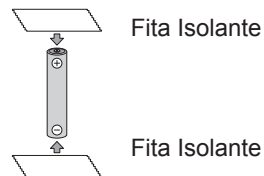

Não desmonte, não remova o invólucro, nem amasse a bateria. O gás liberado pela bateria pode irritar a garganta, danificar o lacre do invólucro ou o vazamento provocar calor, ruptura da blindagem e produzir fogo devido ao curto circuito dos terminais. Não incinere nem aqueça as baterias, elas não podem ficar expostas a temperaturas superiores a 100 °C (212 °F). O gás liberado pela bateria pode irritar a garganta, danificar o lacre do invólucro ou o vazamento provocar calor, ruptura da blindagem e produzir fogo devido ao curto circuito dos terminais provocado internamente.

Evite o contato com o líquido que vazar das baterias. Caso isto ocorra, lave bem a parte afetada com bastante água. Caso haja irritação, consulte um médico.

■ Remoção das baterias

1. Pressione a guia e levante a tampa.

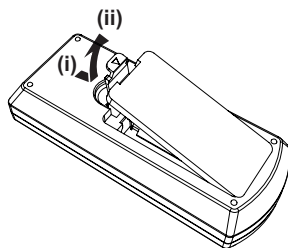

2. Remova as baterias.

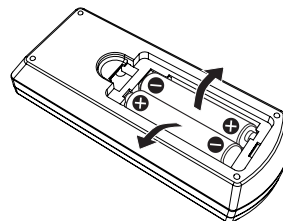

■ Trademarks, etc.

- Windows, Internet Explorer and Microsoft Edge are registered trademarks or trademarks of Microsoft Corporation in the United States and other countries.
- Mac, OS X, macOS, iPad, iPhone, iPod touch and Safari are trademarks of Apple Inc., registered in the United States and other countries.
- The terms HDMI and HDMI High-Definition Multimedia Interface, and the HDMI Logo are trademarks or registered trademarks of HDMI Licensing Administrator, Inc. in the United States and other countries.
- PJLink™ is a registered trademark or pending trademark in Japan, the United States, and other countries and regions.
- RoomView and Crestron RoomView are registered trademarks of Crestron Electronics, Inc. Crestron Connected™ and Fusion RV are trademarks of Crestron Electronics, Inc.
- IOS is a trademark and registered trademark of Cisco in the United States and other countries and is used under license.
- Android is a trademark of Google Inc.
- Adobe, Adobe Flash Player and Adobe Reader are trademarks or registered trademarks of Adobe Systems Inc. in the United States and/or other countries.
- Some of the fonts used in the on-screen menu are Ricoh bitmap fonts, which are manufactured and sold by Ricoh Company, Ltd.
- Other names, company names or product names used in these operating instructions are the trademarks or registered trademarks of their respective holders.
Please note that the operating instructions do not include the ® and ™ symbols.

■ Software information regarding this product

This product incorporates the following software.

- (1) the software developed independently by or for Panasonic Corporation,
- (2) the software owned by third party and licensed to Panasonic Corporation,
- (3) the software licensed under the GNU General Public License, Version 2.0 (GPL V2.0),
- (4) the software licensed under the GNU LESSER General Public License, Version 2.1 (LGPL V2.1), and/or
- (5) open source software other than the software licensed under the GPL V2.0 and/or LGPL V2.1.

The software categorized as (3) - (5) are distributed in the hope that it will be useful, but WITHOUT ANY WARRANTY, without even the implied warranty of MERCHANTABILITY or FITNESS FOR A PARTICULAR PURPOSE. Please refer to the detailed terms and conditions thereof shown in the attached CD-ROM.

At least three (3) years from delivery of this product, Panasonic will give to any third party who contacts us at the contact information provided below, for a charge no more than our cost of physically performing source code distribution, a complete machine-readable copy of the corresponding source code covered under GPL V2.0, LGPL V2.1 or the other licenses with the obligation to do so, as well as the respective copyright notice thereof.

Contact Information: oss-cd-request@gg.jp.panasonic.com

■ Illustrations in these operating instructions

- Illustrations of the projector, screen, and other parts may vary from the actual product.
- Illustrations displayed on the computer screen may differ depending on the computer type and its operating system.
- Illustrations of the projector with the power cord attached are only examples. The shape of the supplied power cords varies depending on the country where you purchased the product.

■ Page references

- Reference pages in this manual are indicated as: (➡ page 00).

■ Term

- In this manual, the “Wireless remote control unit” accessory is referred to as the “Remote control”.

Features of the Projector

Comfortable viewing in a bright environment

- ▶ The high contrast ratio 20 000 : 1 is achieved in a compact body.
- ▶ The low noise level 29 dB*1 supports comfortable viewing during quiet scenes.
- ▶ Even if projected under a bright light, the images can be corrected to optimum vividness by using the <DAYLIGHT VIEW> button on the remote control.

*1 When [LAMP POWER] is set to [ECO]

Abundant image correction function

- ▶ Keystone correction, corner correction and curved correction functions allow you to correct the image to fit the screen.

Useful function for presentations

- ▶ The Memory Viewer function enables you to project still images stored in the USB memory without using a computer.

Quick Steps

For details, see the corresponding pages.

1. **Set up your projector.**
(⇒ page 30)



2. **Connect with other devices.**
(⇒ page 34)



3. **Connect the power cord.**
(⇒ page 38)



4. **Power on.**
(⇒ page 39)



5. **Make initial settings.**
(⇒ page 40)

- Take this step when you power on for the first time after purchasing the projector.



6. **Select the input signal.**
(⇒ page 43)



7. **Adjust the image.**
(⇒ page 44)

Chapter 1 Preparation

This chapter describes things you need to know or check before using the projector.

Precautions for use

Cautions when transporting

- When transporting the projector, hold it securely by its bottom and avoid excessive vibration and impacts. They may damage the internal parts and result in malfunctions.
- Do not transport the projector with the adjustable feet extended. Doing so may damage the adjustable feet.
- Do not move or transport the projector with the wireless module (Model No.: ET-WML100) of the optional accessories attached. Doing so may damage the wireless module.

Cautions when installing

■ Do not set up the projector outdoors.

The projector is designed for indoor use only.

■ Do not set up the projector in the following locations.

- Places where vibration and impacts occur such as in a car or vehicle: Doing so may damage the internal parts and result in malfunctions.
- Location close to sea or where corrosive gas may occur: The projector may fall due to corrosion. Also, failure to do so may shorten the life of the components and result in malfunction.
- Near the exhaust of an air conditioner: Depending on the conditions of use, the screen may fluctuate in rare cases due to the heated air from the air exhaust port or the hot or cooled air from the air conditioner. Make sure that the exhaust from the projector or other equipment, or the air from the air conditioner does not blow toward the front of the projector.
- Places with sharp temperature fluctuations such as near lights (studio lamp): Doing so may shorten the life of the luminous lamp, or result in deformation of the outer case due to heat, which may cause malfunctions. Follow the operating environment temperature of the projector.
- Near high-voltage power lines or near motors: Doing so may interfere with the operation of the projector.

■ Ask a qualified technician or your dealer for the installation work such as installing to a ceiling, etc.

To ensure projector performance and safety, ask a qualified technician or your dealer when installing to a ceiling or in a high place.

■ Focus adjustment

The projection lens is thermally affected by the light from the light source, making the focus unstable in the period just after switching on the power. It is recommended that the images be projected continuously for at least 30 minutes before the focus is adjusted.

■ When using the projector in the elevation of below 1 400 m (4 593'), make sure [HIGH ALTITUDE MODE] is set to [OFF].

Failure to do so may shorten the life of the internal parts and result in malfunctions.

■ When using the projector in the elevation of above 1 400 m (4 593') and below 2 000 m (6 562'), make sure [HIGH ALTITUDE MODE] is set to [HIGH1].

Failure to do so may shorten the life of the internal parts and result in malfunctions.

■ When using the projector in the elevation of above 2 000 m (6 562') and below 2 700 m (8 858'), make sure [HIGH ALTITUDE MODE] is set to [HIGH2].

Failure to do so may shorten the life of the internal parts and result in malfunctions.

■ Do not install the projector at elevations of 2 700 m (8 858') or higher above sea level.

Failure to do so may shorten the life of the internal parts and result in malfunctions.

■ Do not tilt the projector or place it on its side.

Do not tilt the projector body more than approximately $\pm 40^\circ$ vertically or $\pm 15^\circ$ horizontally. Over tilting may result in shortening the life of the components.

The angle that can be corrected through [POSITION] menu → [SCREEN ADJUSTMENT] → [KEYSTONE] is within $\pm 35^\circ$. If the vertical tilt of the projector with respect to the screen surface exceeds 35° , vertical trapezoidal distortion may not be fully corrected.

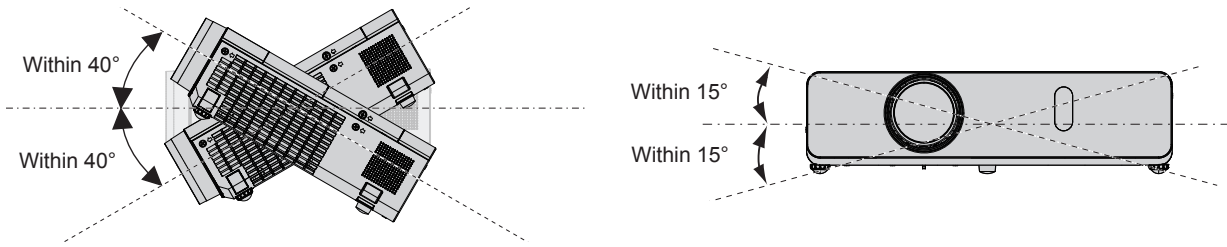

■ Cautions when setting the projectors

- Use the adjustable feet only for the floor standing installation and for adjusting the angle. Using them for other purposes may damage the projector.
- If you want to install the projector with a method other than desk/floor setup using the adjustable feet or ceiling mount with the ceiling mount accessories, use the three screw holes for ceiling mounting (as shown below) to fix the projector.

(Screw: M4; Depth of the screw hole: 8 mm (5/16"); Torque: M4 1.25 ± 0.2 N·m)

In addition, always keep a gap of more than 20 mm (25/32") between the bottom of the projector and installation surface.

Make sure that there is no clearance between the screw holes for ceiling mount on the projector bottom and the installation surface by inserting spacers (metallic) of at least 20 mm (25/32") between them.

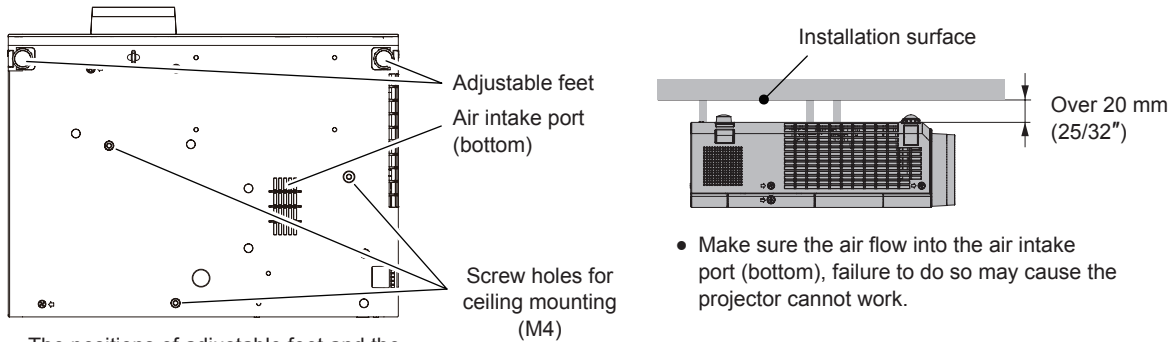

The positions of adjustable feet and the screw holes for ceiling mounting

- Make sure the air flow into the air intake port (bottom), failure to do so may cause the projector cannot work.

- Do not stack the projectors.
- Do not use the projector supporting it by the top.
- Do not block the ventilation ports (intake and exhaust) of the projector.
- Avoid heating and cooling air from the air conditioning system directly blow to the ventilation ports (intake and exhaust) of the projector.

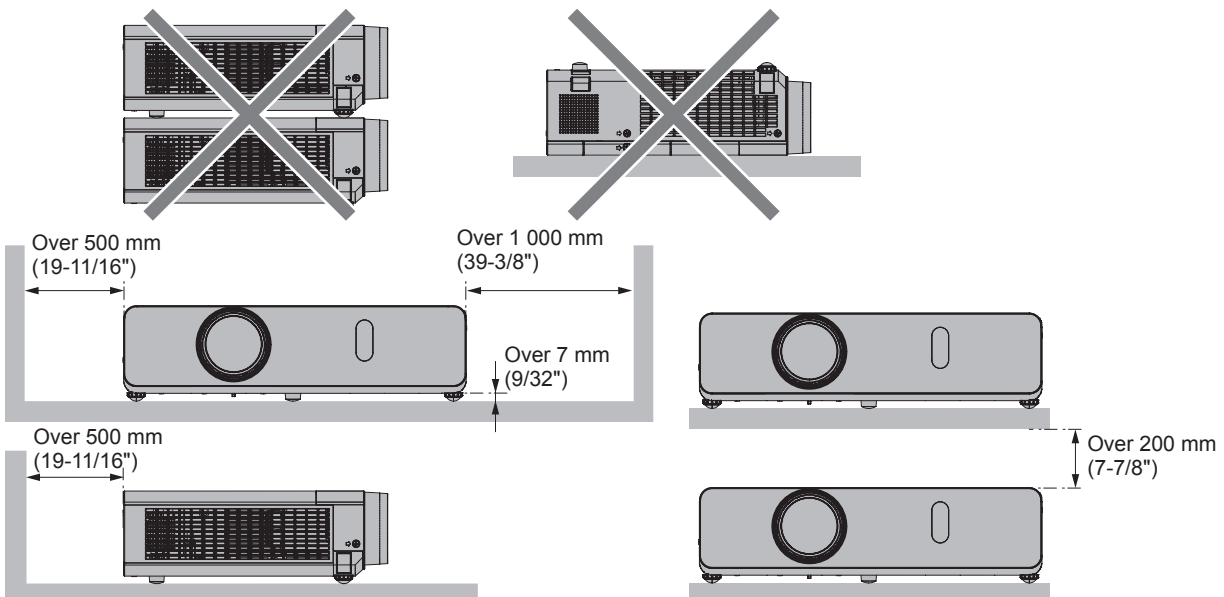

- Do not install the projector in a confined space.
When placing the projector in a confined space, a ventilation and/or air conditioning system is required. Exhaust heat may accumulate when the ventilation is not enough, triggering the protection circuit of the projector.
- Panasonic takes no responsibility for any damage to the product caused by an inappropriate choice of location for installing the projector, even if the warranty period of the product has not expired.

Security

When using this product, take safety measures against following incidents.

- Personal information being leaked via this product.
- Unauthorized operation of this product by a malicious third party.
- Interfering or stopping of this product by a malicious third party.

Take sufficient security measures.

- Make your password as difficult to guess as possible.
- Change your password periodically. The password can be set in [SECURITY] menu → [PASSWORD CHANGE].
- Panasonic Corporation or its affiliate companies will never ask for your password directly. Do not divulge your password in case you receive such inquiries.
- The connecting network must be secured by firewall or others.
- Set a password for the web control and restrict the users who can log in. The web control password can be set on the [Change password] page of the web control screen.

■ Security cautions for using the wireless LAN product

The advantage of a wireless LAN is that information can be exchanged between a PC or other such equipment and an access point using radio waves as long as you are within range for radio transmissions.

On the other hand, because the radio waves can travel through obstacles (such as walls) and are available everywhere within a given range, problems of the type listed below may occur if security-related settings are not made sufficiently.

- Communication content leak

The following communication information may be leaked by a malicious third party who intentionally intercept the transmitted data.

- Personal information such as your ID, password, and/or credit card numbers
- The e-mail content

- Unauthorized access

A malicious third party may access your personal or corporate network without authorization and engage in the following types of behavior.

- Retrieve personal and/or secret information (information leak)
- Spread false information by impersonating a particular person (spoofing)
- Overwrite intercepted communications and issue false data (tampering)
- Spread harmful software such as a computer virus and crash your data and/or system (system crash)

Since most wireless LAN adapters or access points are equipped with security features to take care of these problems, you can reduce the possibility of these problems occurring when using this product by making the appropriate security settings for the wireless LAN device.

Some wireless LAN devices may not be set for security immediately after purchase. To decrease the possibility of occurrence of security problems, before using any wireless LAN devices, be absolutely sure to make all security-related settings according to the instructions given in the operation manuals supplied with them.

Depending on the specifications of the wireless LAN, a malicious third party may be able to break security settings by special means.

Panasonic advises customers to thoroughly understand the risk of using this product without making security settings, and recommends that the customers make security settings at their own discretion and responsibility.

Notes on using wireless connection

Wireless connection function of the projector uses radio waves in the 2.4 GHz band.

A radio station license is not required, but be sure to read and fully understand the following items before use.

The wireless module (Model No.: ET-WML100) of optional accessories must be installed when you want to use the wireless LAN function of the projector.

■ **Do not use near other wireless equipment.**

The following equipment may use radio waves in the same band as the projector.

When the projector is used near these devices, radio wave interference may make communication impossible, or the communication speed may become slower.

- Microwave ovens, etc.
- Industrial, chemical and medical equipment, etc.
- In-plant radio stations for identifying moving objects such as those used in factory manufacturing lines, etc.
- Designated low-power radio stations

■ **If at all possible, avoid the use of cellular phones, TV sets or radios near the projector.**

Cellular phones, TV sets, radios and similar devices use different radio bands from the projector, so there is no effect on wireless communication or the transmission and reception of these devices. However, radio waves from the projector may produce audio or video noise.

■ **Wireless communication radio waves cannot penetrate steel reinforcements, metal, concrete, etc.**

Communication is possible through walls and floors made from materials such as wood and glass (except glass containing wire mesh), but not through walls and floors made from steel reinforcements, metal, concrete, etc.

■ **Avoid using the projector in locations prone to static electricity.**

If the projector is used in a location prone to static electricity, the wireless LAN or wired LAN connection may be lost.

If the static electricity or noise make it impossible to establish a connection with the LAN, disconnect the power plug from the outlet after turning off the projector power, eliminate the source of static electricity or noise, then turn on the projector.

■ **Using the projector outside the country**

Note that depending on countries or regions, there are restrictions on the channels and frequencies at which you can use the wireless LAN.

Application software supported by the projector

The projector supports following application software. For details or downloading each application software, visit the Panasonic website (<https://panasonic.net/cns/projector/>).

• **Logo Transfer Software**

This application software transfers the original image, such as company logo, which is projected at the start, to the projector.

• **Multi Monitoring & Control Software**

This application software monitors and controls the multiple display devices (projector and flat panel display) connected to an intranet.

• **Early Warning Software**

This plug-in software monitors the status of the display devices and their peripherals within an intranet, and notifies of abnormality of such equipment and detects the signs of possible abnormality. "Early Warning Software" is preinstalled in the "Multi Monitoring & Control Software". To use the early warning function of this plug-in software, install "Multi Monitoring & Control Software" in the PC to be used. By enabling the early warning function, it will notify of the approximate time to replace the consumables for the display devices, to clean each part of the display devices, and to replace the components of the display devices, allowing to execute maintenance in advance.

The early warning function can be used by registering maximum of 2048 display devices free of charge for 90 days after installing the "Multi Monitoring & Control Software" into a PC. To continuously use after the 90 days, it is necessary to purchase the license of "Early Warning Software" (ET-SWA100 Series) and perform the activation. Also, depending on the type of license, the number of display devices that can be registered for monitoring varies. For details, refer to the Operating Instructions of "Multi Monitoring & Control Software".

• **Presenter Light Software**

This application software compatible with Windows computers transmits the computer screen to the projector via wireless LAN or wired LAN.

• **Wireless Projector**

This application software for iOS/Android is used to project files such as PDF or image by transmitting to the projector via wireless LAN.

Storage

When storing the projector, keep it in a dry room.

Disposal

To dispose of the product, ask your local authorities or dealer for correct methods of disposal.

The luminous lamp contains mercury. When disposing of used lamp units, contact your local authorities or dealer for correct methods of disposal.

Cautions on use

■ To get a good picture quality

In order to view a beautiful image in higher contrast, prepare an appropriate environment. Draw curtains or blinds over windows and turn off any lights near the screen to prevent outside light or light from indoor lamp from shining onto the screen.

■ Do not touch the surface of the projector lens with your bare hands.

If the surface of the projection lens becomes dirty from fingerprints or anything else, this will be magnified and projected onto the screen.

It is recommended to attach the supplied lens cap to the projection lens when you do not use the projector.

■ LCD panel

The LCD panel is precision-made. Note that in rare cases, pixels of high precision could be missing or always lit. Note that such phenomena do not indicate malfunction. If still images are projected for a long time, a residual image may remain on the LCD panel. Note that the residual image may not disappear.

■ Optical parts

When the operating environment temperature is high or in environments where lots of dust, cigarette smoke, etc. is present, the replacement cycle of the LCD panel, polarizing plate and other optical parts may be shorter even if used for less than one year. Consult your dealer for details.

■ Luminous lamp

The light source of the projector is a mercury lamp with high internal pressure.

A high-pressure mercury lamp has the following characteristics.

- The luminance of the luminous lamp will decrease by duration of usage.
- The luminous lamp may burst with a loud sound or have its service life shortened because of shock, chipping, or degradation due to cumulative runtime.
- The life of the luminous lamp varies greatly depending on individual specificities and usage conditions. In particular, continuous use over 12 hours and frequent switching off/on of the power greatly deteriorate the luminous lamp and affect the luminous lamp life.
- In rare cases, the luminous lamp burst shortly after the projection.
- The risk of bursting increases when the luminous lamp is used beyond its replacement cycle. Make sure to replace the lamp unit consistently. ("When to replace the lamp unit" (➔ page 118), "Replacing the lamp unit" (➔ page 118))
- If the luminous lamp bursts, gas contained inside of the luminous lamp is released in a form of smoke.
- It is recommended to store replacement lamp for contingency.

■ Computer and external device connections

When connecting a computer or an external device, read this manual carefully regarding the use of power cords and shielded cables as well.

Accessories

Make sure the following accessories are provided with your projector. Numbers enclosed < > show the number of accessories.

Wireless remote control unit <1>

(N2QAYA000154)

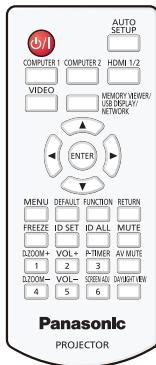

CD-ROM <1>

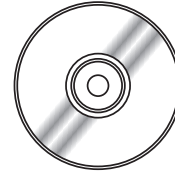

(Operating Instructions are included.)

AAA/R03 or AAA/LR03 battery <2>

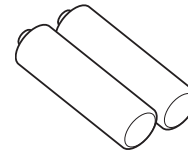

(for remote control unit)

Power cord

(TXFSX02UXRZ)

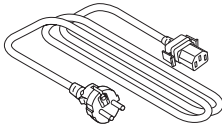

(TXFSX02UYAZ)

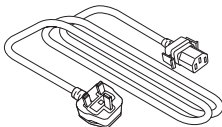

(TXFSX02UFEZ)

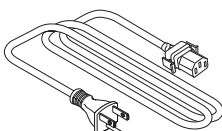

String <1>

(6103504711)

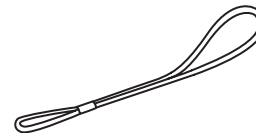

(For lens cap)

RGB signal cable <1>

(K1HY15YY0012)

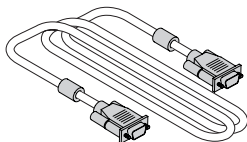

Lens cap <1>

(TKKL5568-1)

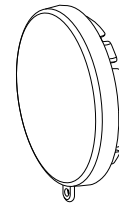

Attention

- After unpacking the projector, discard the power cord cap and packaging material properly.
- Do not use the supplied power cord for devices other than this projector.
- For lost accessories, consult your dealer.
- Store small parts in an appropriate manner, and keep them away from young children.

Note

- The type and number of the power cord depend on the country in which you purchased the product.
- The model numbers of accessories are subject to change without prior notice.

Optional accessories

Options	Model No.
Ceiling Mount Bracket	ET-PKL100H (for high ceilings) ET-PKL100S (for low ceilings) ET-PKV400B (Projector Mount Bracket)
Replacement Lamp Unit	ET-LAV300
Replacement Filter Unit	ET-RFV300
D-SUB - S Video conversion cable	ET-ADSV
Wireless Module	ET-WML100 *1
Early Warning Software (Basic license/3-year license)	ET-SWA100 series *2

*1 This product cannot be purchased in some countries. For details, contact your dealer.

*2 The suffix of the Model No. differs according to the license type.

Note

- The model numbers of optional accessories are subject to change without prior notice.

About your projector

Remote control

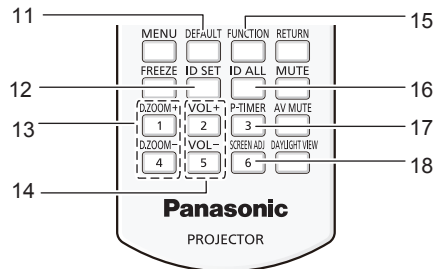
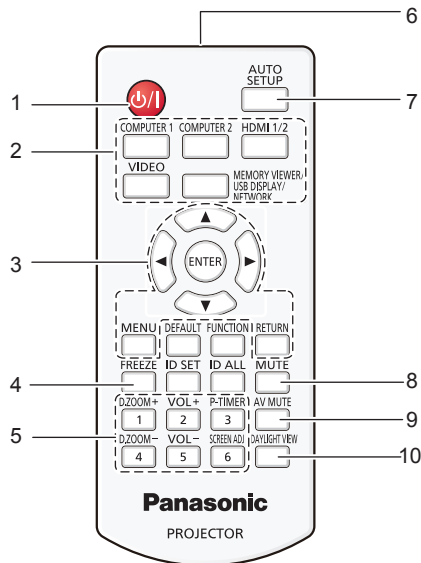

- 1 Power <⏻/▶> button (⏻ Standby / ▶ Power on)**
Sets the projector to the state where the projector is switched off (standby mode). Also starts projection when the power is switched off (standby mode).
- 2 Input selection buttons (<COMPUTER 1> / <COMPUTER 2> / <HDMI 1/2> / <VIDEO> / <MEMORY VIEWER/USB DISPLAY/NETWORK>)**
Switches the input signal to project. (➡ page 43)
- 3 <MENU> button / <RETURN> button / ▲▼◀▶ buttons / <ENTER> button**
Used to navigate through the menu screen. (➡ page 52)
The ▲▼◀▶ buttons are also used to enter password or characters for [SECURITY].
- 4 <FREEZE> button**
Pauses the projected image and mute the audio temporarily. (➡ page 46)
- 5 Number (<1> - <6>) buttons**
Used for entering the ID number in a multiple projector environment or a password.
- 6 Remote control signal transmitter**
- 7 <AUTO SETUP> button**
Used to perform automatic adjustment while projecting the image (➡ page 47).
- 8 <MUTE> button**
Used to mute the audio. (➡ page 46)
- 9 <AV MUTE> button**
Used to turn off the audio and video temporarily. (➡ page 46)

- 10 <DAYLIGHT VIEW> button**
Used to correct the image when the projector is used in a bright surroundings. (➡ pages 49, 58)
- 11 <DEFAULT> button**
Resets the content of the sub-menu to the factory default. (➡ page 53)
- 12 <ID SET> button**
Sets the projector ID on the remote control for a system using multiple projectors. (➡ page 27)
- 13 <D.ZOOM+> button / <D.ZOOM-> button**
Zooms in and out the images. (➡ page 48)
- 14 <VOL+> button / <VOL-> button**
Adjusts the volume level of the built-in speaker or the audio output. (➡ page 46)
- 15 <FUNCTION> button**
Specifies a shortcut button for a frequently used operation. (➡ page 49)
- 16 <ID ALL> button**
Used to simultaneously control all the projectors with one remote control when using multiple projectors. (➡ page 27)
- 17 <P-TIMER> button**
Operate the P-TIMER function. (➡ page 48)
- 18 <SCREEN ADJ> button**
Corrects the distortion of the projected image. (➡ page 47)

Attention

- Do not drop the remote control.
 - Avoid contact with liquids.
 - Do not attempt to modify or disassemble the remote control.
 - Please observe the following contents that are described on the back of the remote control unit (see the right picture).
 - Do not use a new battery together with an old battery.
 - Do not use unspecified batteries.
 - Make sure the polarities (+ and -) are correct when inserting the batteries.
- In addition, please read the contents that are related to batteries in the "Read this first!".

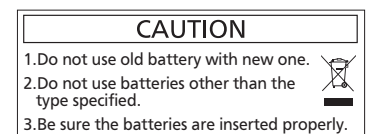

Caution label at the back of the remote control

Note

- The remote control can be used within a distance of about 7 m (22'11-5/8") if pointed directly at the remote control signal receiver. The remote control can control at angles of up to $\pm 30^\circ$ vertically and $\pm 30^\circ$ horizontally, but the effective control range may be reduced.
- If there are any obstacles between the remote control and the remote control signal receiver, the remote control may not operate correctly.
- You can operate the projector by reflecting the remote control signal on the screen. The operating range may differ due to the loss of light caused by the properties of the screen.
- When the remote control signal receiver is lit with a fluorescent light or other strong light source, the projector may become inoperative. Set the projector as far from the luminous source as possible.

Projector body

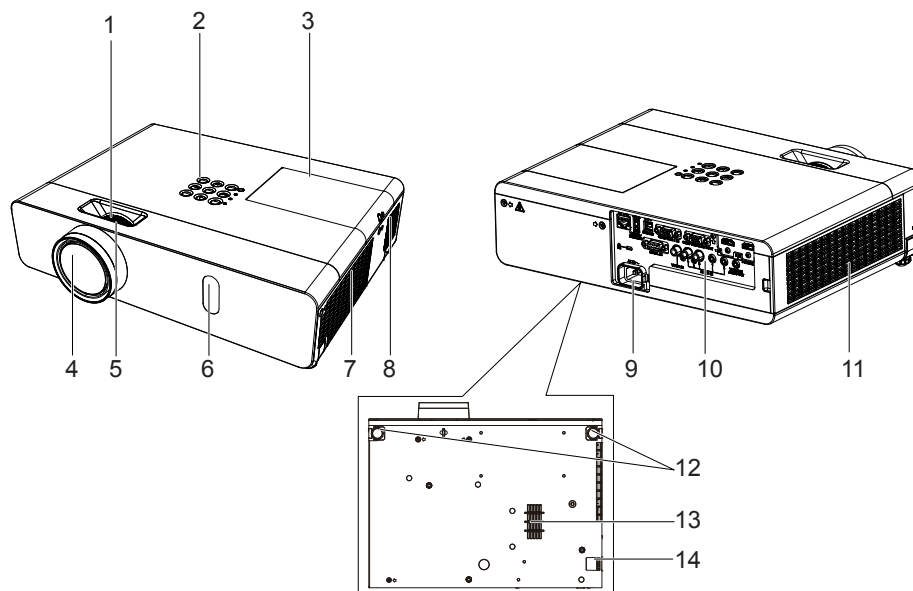

WARNING

Keep your hands and other objects away from the air exhaust port.

- Keep your hand and face away.
- Do not insert your finger.
- Keep heat-sensitive articles away.

Heated air from the air exhaust port can cause burns or external damage.

- | | |
|--|---|
| <p>1 Zoom ring (Back)
Adjust the zoom.</p> <p>2 Control panel and indicators (⇒ page 25)</p> <p>3 Lamp cover (⇒ page 118)
The lamp unit is located inside.</p> <p>4 Projection Lens</p> <p>5 Focus ring (Front)
Adjust the focus.</p> <p>6 Remote control signal receiver</p> <p>7 Air exhaust port</p> | <p>8 Speaker</p> <p>9 <AC IN> terminal
Connect the supplied power cord.</p> <p>10 Connecting terminals (⇒ page 26)</p> <p>11 Air intake port (Side) / Air filter cover (⇒ page 116)
The air filter unit is inside.</p> <p>12 Adjustable feet
Adjust the projection angle.</p> <p>13 Air intake port (Bottom)</p> <p>14 Security Chain Hook
Attaches a burglar prevention cable, etc.</p> |
|--|---|

Attention

- Do not block the ventilation ports (intake and exhaust) of the projector.
- If you turn the power off with the direct power off function with the projector installed upside-down, or if you turn the projector upside-down after turning off the power using the direct power off function, do not put your hands or objects close to the air inlet (bottom) due to the back flow of heated air from the air inlet(bottom). It may cause burns, injuries or deformation.

■ Control panel and indicators

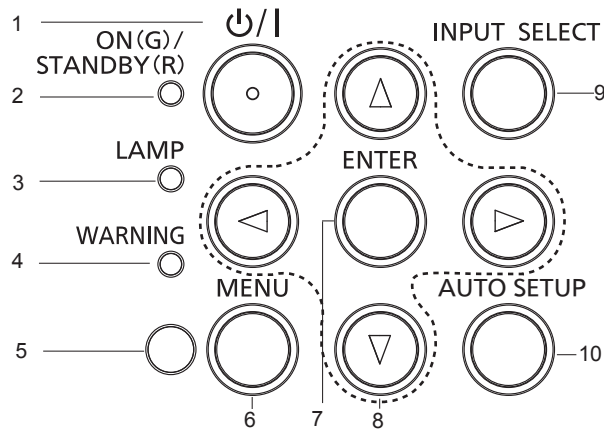

- | | |
|--|--|
| <p>1 Power <⏻/⏻> button (⏻ standby / power on)
Sets the projector to the state where the projector is switched off (standby mode). Also starts projection when the power is switched off (standby mode).</p> <p>2 Power indicator <ON(G)/STANDBY(R)>
Displays the status of the power.</p> <p>3 Lamp indicator <LAMP>
Displays the status of the luminous lamp.</p> <p>4 Warning indicator <WARNING>
Indicates the abnormal conditions of the projector.</p> <p>5 Ambient Luminance sensor</p> <p>6 <MENU> button
Displays or hides the main menu. (➡ page 52)
When the sub menu is displayed, pressing it will return to the previous screen.</p> | <p>7 <ENTER> button
Determines and executes an item in the menu screen.</p> <p>8 ▲▼◀▶ buttons
Selects an item in the menu screen, changes the setting, and adjusts the level.
Also used to enter a password in the [SECURITY] menu or enter characters.</p> <p>9 <INPUT SELECT> button
Selects the input signal for projection. (➡ page 43)</p> <p>10 <AUTO SETUP> button
Automatically adjusts the screen display position when projecting the image. (➡ page 47)</p> |
|--|--|

■ Connecting terminals

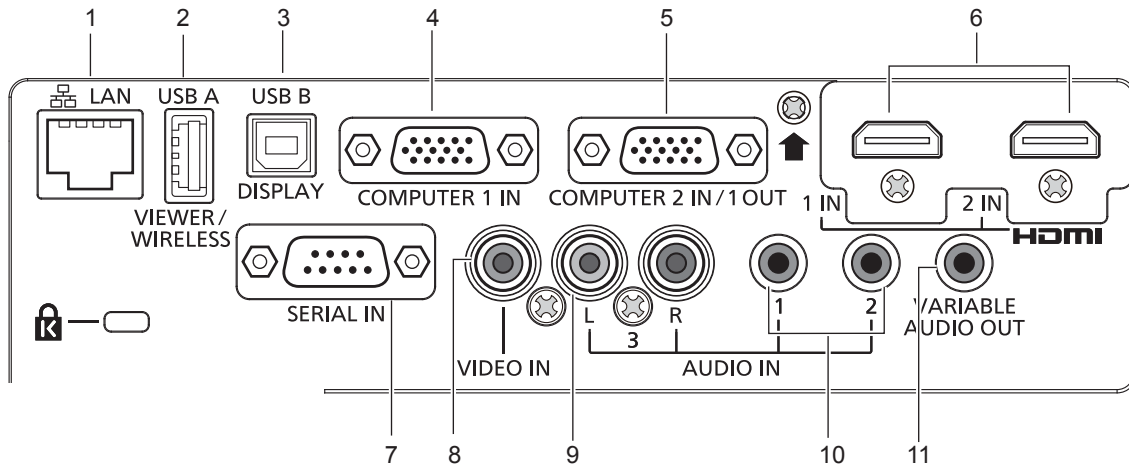

1 <LAN> terminal

This is the LAN terminal to connect to the network.

2 <USB A (VIEWER/WIRELESS)> terminal

When using the Memory Viewer function, attach the USB memory directly to this terminal. (➔ page 90)
Please attach the wireless module (Model No.: ET-WML100) directly to this terminal when using the wireless LAN function. (➔ page 95)

3 <USB B (DISPLAY)> terminal

This terminal is used to connect the projector to the computer with a USB cable when you want to use the USB display function.

4 <COMPUTER 1 IN> terminal

This is the terminal to input RGB signals, $Y C_B C_R / Y P_B P_R$ signals, or Y/C signals.

5 <COMPUTER 2 IN/1 OUT> terminal

This is the terminal to input RGB signals or $Y C_B C_R / Y P_B P_R$ signals. It can also output the signals input from <COMPUTER 1 IN> terminal to an external device.

6 <HDMI 1 IN> terminal / <HDMI 2 IN> terminal

These are the terminals to input HDMI signal.

7 <SERIAL IN> terminal

This is the RS-232C compatible terminal to externally control the projector by connecting a computer.

8 <VIDEO IN> terminal

This is the terminal to input video signals.

9 <AUDIO IN 3 (L/R)> terminal

This is the terminal to input audio signals. Left input (L) and right input (R) are provided for the <AUDIO IN 3> terminal.

10 <AUDIO IN 1> terminal / <AUDIO IN 2> terminal

These are the terminals to input audio signals.

11 <VARIABLE AUDIO OUT> terminal

This is the terminal to output the input audio signal to the projector.

Attention

- When a LAN cable is directly connected to the projector, the network connection must be made indoors.

Preparing the remote control

Inserting and removing batteries

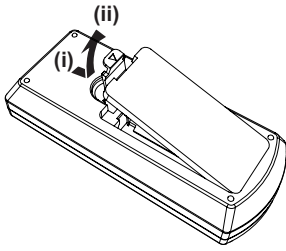

Fig.1

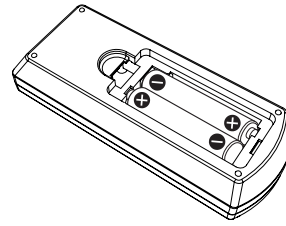

Fig.2

- 1) **Open the cover. (Fig. 1)**
- 2) **Insert batteries and close the cover. (Insert the "⊖" side first.) (Fig. 2)**
 - When removing the batteries, perform the steps in reverse order.

When using the system with multiple projectors

When you use the system with multiple projectors, you can operate all the projectors simultaneously or each projector individually by using single remote control, if a unique ID number is assigned to each projector.

When you want to set the ID number, at first you need to complete the Initial setting, and then after setting the ID number of the projector, set the ID number on the remote control. About Initial setting, please refer to "When the initial setting screen is displayed" (➡ page 40).

The factory default ID number of the unit (the projector and the remote control) is set to [ALL], you can control with this setting. If necessary, please set the ID number to the remote control and the projector. About how to set the ID number of the remote control, please refer to "Setting the ID number of the remote control" (➡ page 49).

Note

- Set the ID number of the projector from the [PROJECTOR SETUP] menu → [PROJECTOR ID] (➡ page 75).

Attaching the lens cap

When moving this projector or while not using it over an extended period of time, it is recommended to attach the lens cap to avoid contaminating the lens.

To prevent loss of the lens cap, please attach the lens cap with the string of accessories according to the following procedures.

- 1) Thread the thinner end of the string through the hole on the lens cap.

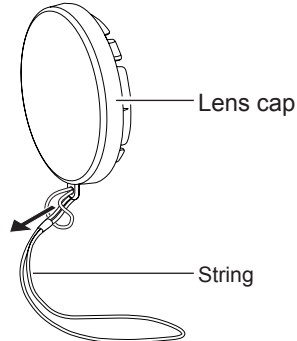

- 2) Thread the other side (the side with larger ring) of the string through the hole at the bottom of the projector and fasten it.

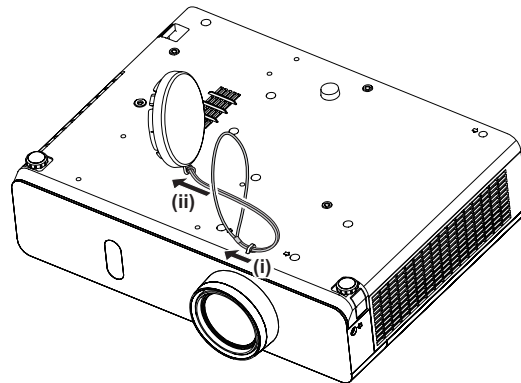

Chapter 2 **Getting Started**

This chapter describes things you need to do before using the projector such as the setup and connections.

Setting up

Installation mode

There are four ways to set up the projector. Set the [PROJECTOR SETUP] menu → [PROJECTION METHOD] (➔ page 75) depending on the installation location.

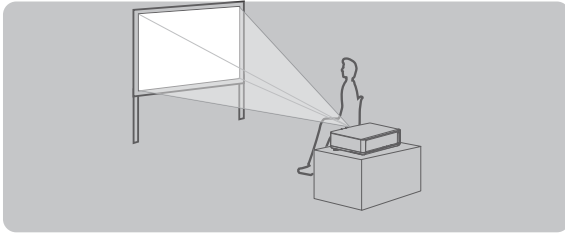
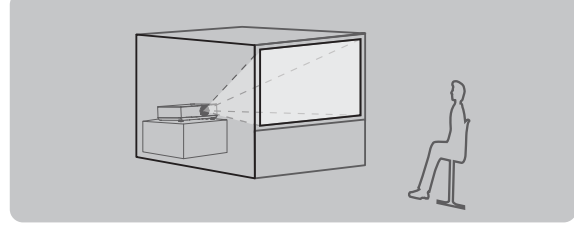
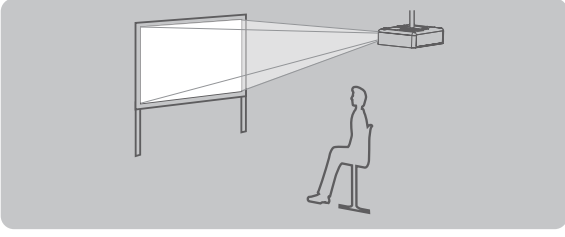
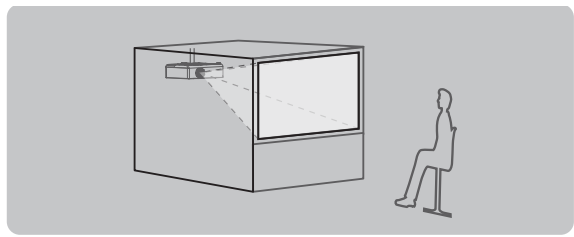
Setting on a desk/floor and projecting forward 		Setting on a desk/floor and projecting from rear (Using the translucent screen) 	
Menu item	Method	Menu item	Method
[PROJECTION METHOD]	[AUTO] or [FRONT/DESK]	[PROJECTION METHOD]	[REAR/DESK]
Mounting on the ceiling and projecting forward 		Mounting on the ceiling and projecting from rear (Using the translucent screen) 	
Menu item	Method	Menu item	Method
[PROJECTION METHOD]	[AUTO] or [FRONT/CEILING]	[PROJECTION METHOD]	[REAR/CEILING]

Note

- The projector has a built-in angle sensor. The attitude of the projector is automatically detected by setting the [PROJECTOR SETUP] menu → [PROJECTION METHOD] to [AUTO]. For rear projection, set the [PROJECTION METHOD] to [REAR/DESK] or [REAR/CEILING].

■ Angle sensor

The range of installation posture detected by the projector's built-in angle sensor is as follows.

In case of [AUTO], when the projector is placed with the top side upward within $\pm 40^\circ$ from the horizontal plane, it will switch to [FRONT/DESK] automatically; when the projector is placed with the top side downward within $\pm 30^\circ$ from the horizontal plane, it will switch to [FRONT/CEILING] automatically.

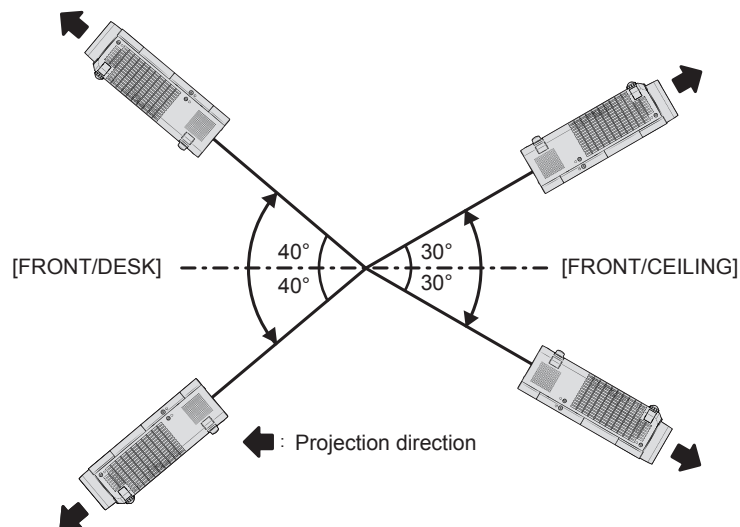

In the case of [AUTO], it will be detected as [FRONT/DESK] even when the projector tilts over $\pm 40^\circ$ with the top side upward or over $\pm 30^\circ$ with the top side downward. To use the projector that tilts over $\pm 30^\circ$ with the top side downward, set the [PROJECTOR SETUP] menu → [PROJECTION METHOD] to [FRONT/CEILING] or [REAR/CEILING] instead of [AUTO].

However, do not use the projector when it exceeds $\pm 40^\circ$ with respect to the horizontal plane. Doing so may shorten the life of the parts.

Parts for ceiling mount (optional)

This requires an optional ceiling mount bracket. Be sure to use the Projector Mount Bracket together with the ceiling mount bracket for high ceilings or low ceilings.

Model No.:

- ① ET-PKL100H (for high ceilings), ET-PKV400B (Projector Mount Bracket)
- ② ET-PKL100S (for low ceilings), ET-PKV400B (Projector Mount Bracket)

- Use only the ceiling mount brackets specified for this projector.
- Refer to the Installation Instructions for the ceiling mount bracket when you install the bracket and the projector.

Attention

- To ensure projector performance and security, installation of the ceiling mount bracket must be carried by your dealer or a qualified technician.

Screen size and throw distance

Refer to the screen size and projection distances to install the projector. Image size and image position can be adjusted in accordance with the screen size and screen position.

- Following illustration is prepared on the assumption that the projected image size and position have been aligned to fit full in the screen.

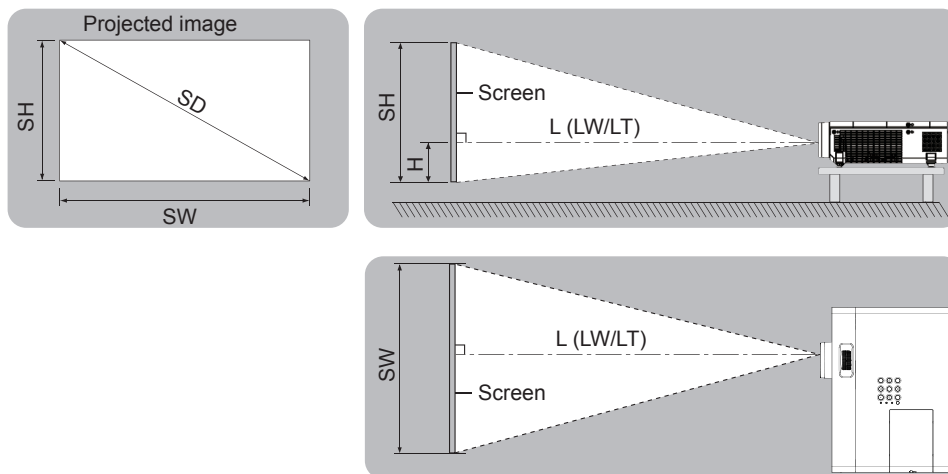

(Unit: m)

L (LW/LT) *1	Projection distance
SH	Image height
SW	Image width
H	Distance from the center of lens to the image lower end
SD	Projected image size

*1 LW : Minimum distance
 LT : Maximum distance

Attention

- Before installing, please read "Precautions for Use" (➡ page 16).

Projection distance

A ±5 % error in listed projection distances may occur.

When [SCREEN ADJUSTMENT] is used, distance is corrected to become smaller than the specified image size.

For PT-VW360

(Unit: m)

Projection size	For 16:10 aspect ratio			For 16:9 aspect ratio			For 4:3 aspect ratio		
	Screen diagonal (SD)	Minimum distance (LW)	Maximum distance (LT)	Height position (H)	Minimum distance (LW)	Maximum distance (LT)	Height position (H)	Minimum distance (LW)	Maximum distance (LT)
0.76 (30")	0.73	1.21	0.008	0.76	1.24	-0.012	0.83	1.37	0.009
1.02 (40")	0.99	1.63	0.011	1.02	1.68	-0.017	1.13	1.85	0.012
1.27 (50")	1.25	2.04	0.013	1.28	2.09	-0.021	1.41	2.31	0.015
1.52 (60")	1.50	2.44	0.016	1.54	2.51	-0.025	1.70	2.77	0.018
1.78 (70")	1.76	2.87	0.019	1.81	2.95	-0.029	1.99	3.25	0.021
2.03 (80")	2.01	3.27	0.022	2.07	3.37	-0.033	2.28	3.71	0.024
2.29 (90")	2.27	3.70	0.024	2.33	3.80	-0.037	2.57	4.19	0.027
2.54 (100")	2.52	4.10	0.027	2.59	4.22	-0.041	2.86	4.65	0.030
3.05 (120")	3.03	4.93	0.032	3.12	5.07	-0.050	3.44	5.59	0.037
3.81 (150")	3.80	6.17	0.040	3.90	6.34	-0.062	4.30	6.99	0.046
5.08 (200")	5.07	8.24	0.054	5.21	8.47	-0.083	5.74	9.33	0.061
6.35 (250")	6.34	10.30	0.067	6.52	10.59	-0.104	7.19	11.67	0.076
7.62 (300")	7.62	12.37	0.081	7.83	12.72	-0.124	8.63	14.01	0.091

For PT-VX430

(Unit: m)

Projection size	For 4:3 aspect ratio			For 16:9 aspect ratio			For 16:10 aspect ratio		
	Screen diagonal (SD)	Minimum distance (LW)	Maximum distance (LT)	Height position (H)	Minimum distance (LW)	Maximum distance (LT)	Height position (H)	Minimum distance (LW)	Maximum distance (LT)
0.76 (30")	0.69	1.14	0.046	0.75	1.24	-0.012	0.73	1.21	0.008
1.02 (40")	0.94	1.54	0.061	1.02	1.68	-0.017	0.99	1.63	0.011
1.27 (50")	1.17	1.92	0.076	1.28	2.09	-0.021	1.24	2.04	0.013
1.52 (60")	1.41	2.30	0.091	1.54	2.51	-0.025	1.49	2.44	0.016
1.78 (70")	1.65	2.70	0.107	1.81	2.94	-0.029	1.76	2.86	0.019
2.03 (80")	1.89	3.08	0.122	2.06	3.36	-0.033	2.01	3.27	0.022
2.29 (90")	2.14	3.48	0.137	2.33	3.80	-0.037	2.27	3.69	0.024
2.54 (100")	2.37	3.87	0.152	2.59	4.21	-0.041	2.52	4.10	0.027
3.05 (120")	2.86	4.65	0.183	3.11	5.07	-0.050	3.03	4.93	0.032
3.81 (150")	3.58	5.81	0.229	3.90	6.33	-0.062	3.79	6.16	0.040
5.08 (200")	4.78	7.76	0.305	5.21	8.45	-0.083	5.06	8.22	0.054
6.35 (250")	5.98	9.70	0.381	6.52	10.57	-0.104	6.34	10.29	0.067
7.62 (300")	7.18	11.65	0.457	7.82	12.70	-0.124	7.61	12.35	0.081

Projection distance formulas

Any other projection distance can be obtained according to the screen dimensions (m) by using the following calculations.

The calculated distance may contain a certain error.

If you want to calculate the projection distance with projected image size SD (unit: inch) by substituting, please assign 0.0254 times to the SD value.

For PT-VW360

	For 16:10 aspect ratio	For 16:9 aspect ratio	For 4:3 aspect ratio
Screen height (SH)	= 0.530 × SD(m)	= 0.490 × SD(m)	= 0.6 × SD(m)
Screen width (SW)	= 0.848 × SD(m)	= 0.872 × SD(m)	= 0.8 × SD(m)
Minimum distance (LW)	= 1.0037 × SD(m) - 0.0290	= 1.0316 × SD(m) - 0.0290	= 1.1363 × SD(m) - 0.0290
Maximum distance (LT)	= 1.6273 × SD(m) - 0.0292	= 1.6725 × SD(m) - 0.0292	= 1.8422 × SD(m) - 0.0292

For PT-VX430

	For 4:3 aspect ratio	For 16:9 aspect ratio	For 16:10 aspect ratio
Screen height (SH)	= 0.6 × SD(m)	= 0.490 × SD(m)	= 0.530 × SD(m)
Screen width (SW)	= 0.8 × SD(m)	= 0.872 × SD(m)	= 0.848 × SD(m)
Minimum distance (LW)	= 0.9461 × SD(m) - 0.0295	= 1.0307 × SD(m) - 0.0295	= 1.0028 × SD(m) - 0.0295
Maximum distance (LT)	= 1.5324 × SD(m) - 0.0272	= 1.6696 × SD(m) - 0.0272	= 1.6244 × SD(m) - 0.0272

Connecting

Before connecting

- Before connecting, carefully read the operating instructions for the external device to be connected.
- Turn off the power switch of the devices before connecting cables.
- Take note of the following points before connecting the cables. Failure to do so may result in malfunctions.
 - When connecting a cable to a device connected to the projector or the projector itself, touch any nearby metallic objects to eliminate static electricity from your body before performing work.
 - Do not use unnecessarily long cables to connect to a device connected to the projector or to the projector body. The longer the cable, the more it is susceptible to noise. Since using a cable while it is wound makes it act like an antenna, it is more susceptible to noise.
 - When connecting cables, connect GND first, then insert the connecting terminal of the connecting device in a straight manner.
- If any connection cable is not supplied with the device, or if no optional cable is available for connection of the device, prepare a necessary system connection cable to suit the device.
- Video signals containing too much jitter may cause the images on the screen to randomly wobble or wafture. In this case, a time base corrector (TBC) must be connected.
- The projector accepts VIDEO signals, Y/C signals, $YC_B C_R / YP_B P_R$ signals and analog RGB signals (synchronous signals are TTL level), and digital signal.
- Some computer models or graphics cards are not compatible with the projector.
- When using long cables to connect with each of equipment to the projector, there is a possibility that the image will not be output correctly unless a compensator is used.
- For details on what video signals the projector supports, see "List of compatible signals". (➔ page 128)

<COMPUTER 1 IN> terminal pin assignments and signal names

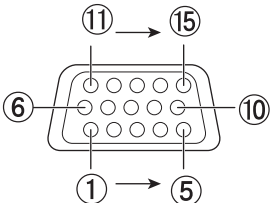
Outside view	Pin No.	Signal names	Pin No.	Signal names
	①	R/P _R /C	⑨	+ 5 V
	②	G/Y/Y	⑩	GND
	③	B/P _B	⑪	GND
	④	—	⑫	DDC data
	⑤	GND	⑬	HD/SYNC
	⑥	GND	⑭	VD
	⑦	GND	⑮	DDC clock
	⑧	GND		

<COMPUTER 2 IN/1 OUT> terminal pin assignments and signal names

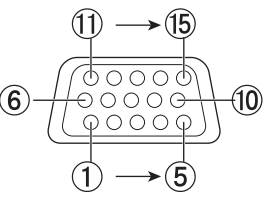
Outside view	Pin No.	Signal names	Pin No.	Signal names
	①	R/P _R	⑨	+5 V
	②	G/Y	⑩	GND
	③	B/P _B	⑪	—
	④	—	⑫	DDC data
	⑤	GND	⑬	HD/SYNC
	⑥	GND	⑭	VD
	⑦	GND	⑮	DDC clock
	⑧	GND		

<HDMI 1 IN> terminal / <HDMI 2 IN> terminal pin assignments and signal names

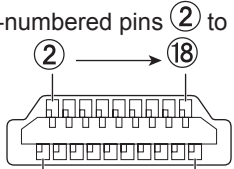
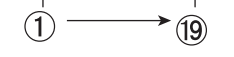
Outside view	Pin No.	Signal names	Pin No.	Signal names
<p>Even-numbered pins ② to ⑱</p>  <p>Odd-numbered pins ① to ⑲</p> 	①	T.M.D.S data 2+	⑪	T.M.D.S clock shield
	②	T.M.D.S data 2 shield	⑫	T.M.D.S clock -
	③	T.M.D.S data 2-	⑬	CEC
	④	T.M.D.S data 1+	⑭	—
	⑤	T.M.D.S data 1 shield	⑮	SCL
	⑥	T.M.D.S data 1-	⑯	SDA
	⑦	T.M.D.S data 0+	⑰	DDC/CEC GND
	⑧	T.M.D.S data 0 shield	⑱	+5 V
	⑨	T.M.D.S data 0-		Hot plug detection
	⑩	T.M.D.S clock +		

Connecting example : AV equipment

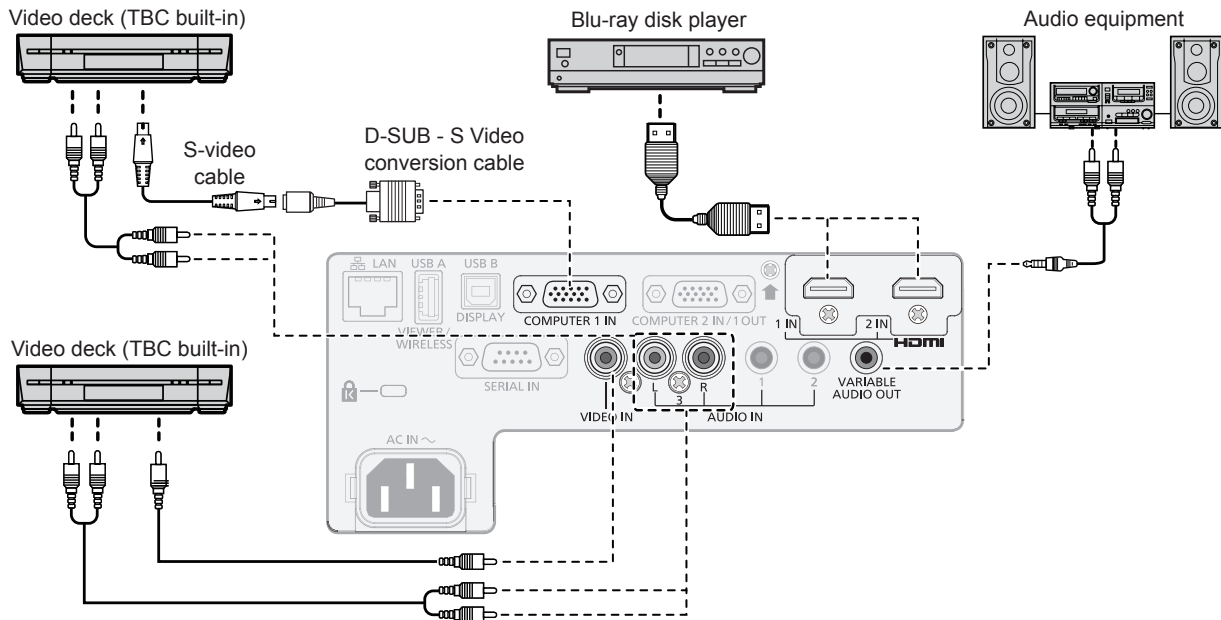

Attention

- Always use one of the following when connecting a VCR.
 - A VCR with built-in time base corrector (TBC).
 - A time base corrector (TBC) between the projector and the VCR.
- If nonstandard burst signals are connected, the image may be distorted. In such case, connect the time base corrector (TBC) between the projector and the external devices.

Note

- For the HDMI cable, use an HDMI High Speed cable that conforms to the HDMI standards. If a cable that does not conform to the HDMI standards is used, images may be interrupted or may not be projected.
- The <HDMI 1 IN> terminal / <HDMI 2 IN> terminal can be connected to an external device with the DVI-D terminal by using an HDMI/DVI conversion cable. However, this may not function properly for some external devices, and image may not be projected.
- This projector does not support the Viera link (HDMI).
- To output audio, properly set the [PROJECTOR SETUP] menu → [AUDIO SETTING] → [AUDIO IN SELECT].
- When Y/C signals are input to the <COMPUTER 1 IN> terminal, switch the setting by using the [PROJECTOR SETUP] menu → [COMPUTER1 INPUT SETTING] (➔ page 74). In addition, When Y/C signals are input, please use the optional D-SUB - S Video conversion cable (Model No.: ET-ADSV).
- When the <VARIABLE AUDIO OUT> terminal is connected with cable, the sound will not be output from the built-in speaker.

Connecting example : Computers

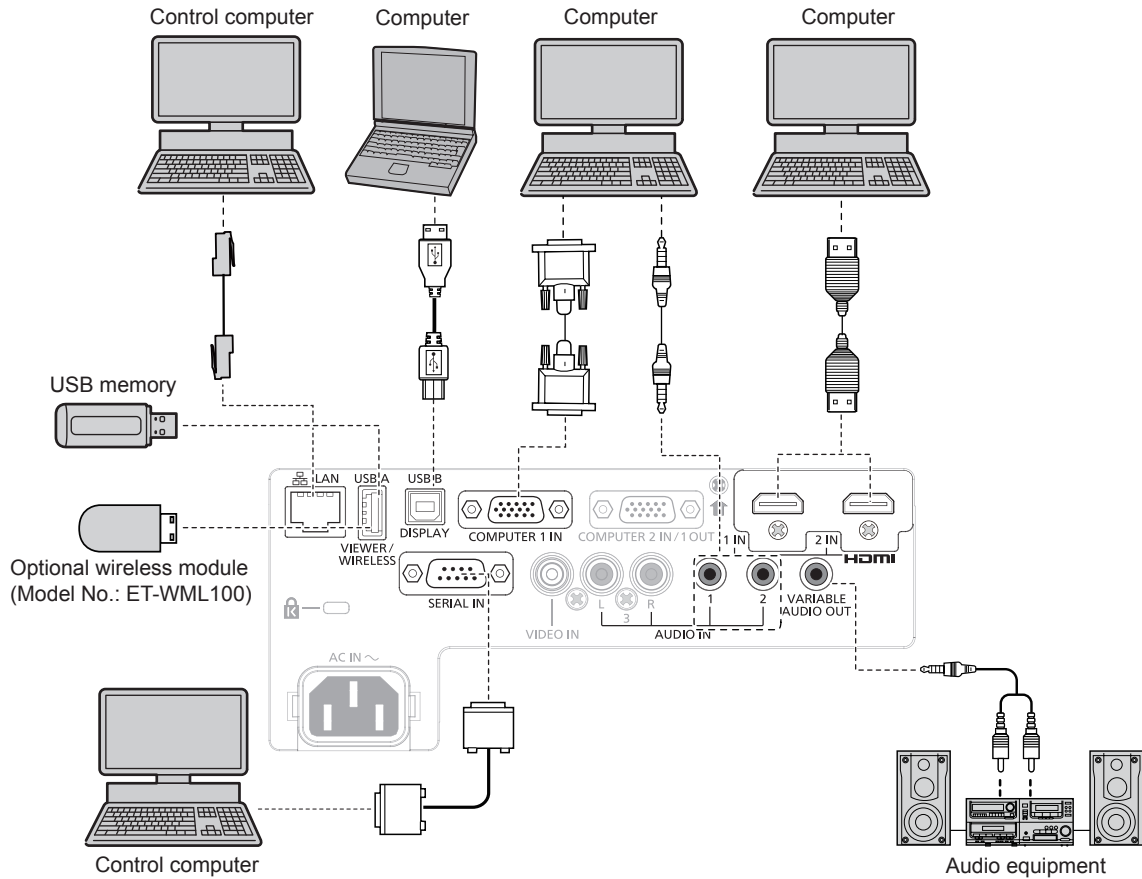

Attention

- When connecting the projector to a computer or an external device, use the power cord supplied with each device and commercially available shielded cables.

Note

- For the HDMI cable, use an HDMI High Speed cable that conforms to the HDMI standards. If a cable that does not conform to the HDMI standards is used, images may be interrupted or may not be projected.
- The <HDMI 1 IN> terminal / <HDMI 2 IN> terminal can be connected to an external device with the DVI-D terminal by using an HDMI/DVI conversion cable. However, this may not function properly for some external devices, and image may not be projected.
- If you operate the projector using the computer with the resume feature (last memory), you may have to reset the resume feature to operate the projector.
- To output audio, properly set the [PROJECTOR SETUP] menu → [AUDIO SETTING] → [AUDIO IN SELECT].
- Attach the optional wireless module (Model No.: ET - WML100) or USB memory directly to the <USB A (VIEWER/WIRELESS)> terminal of this projector without using a USB extension cable or USB hub.
- When the <VARIABLE AUDIO OUT> terminal is connected with cable, the sound will not be output from the built-in speaker.

Chapter 3 **Basic Operations**

This chapter describes basic operations to start with.

Powering on/off

Connecting the power cord

Make sure that the supplied power cord is securely fixed to the <AC IN> terminal of the projector body to prevent it from being removed easily.

For details of power cord handling, refer to “Read this first!” (➔ page 4).

Attaching the power cord

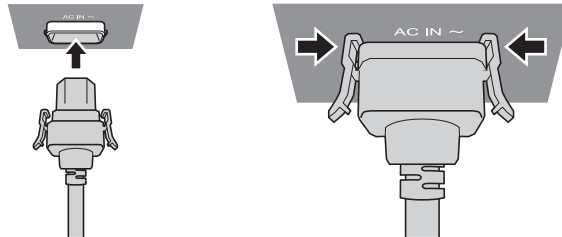

- 1) Check the shapes of the <AC IN> terminal at the rear of the projector and the power cord connector, and insert the connector completely in the correct direction.
- 2) Make sure that the tabs on the left and right sides of the connector are securely engaged with the lugs of the <AC IN> terminal.

Attention

- Do not use the power cord with its tabs damaged. Doing so may result in a poor contact between the power cord connector and the <AC IN> terminal. Consult your dealer for repairing the power cord.

Removing the power cord

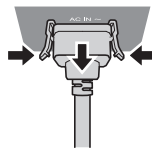

- 1) Confirm that the projector is in standby mode, and remove the power plug from the outlet.
- 2) Remove the power cord connector from the <AC IN> terminal of the projector body while pressing the side tabs.

Attention

- Do not pull out the connector with its left and right tabs engaged with the lugs of <AC IN> terminal. If you pull it out while the tabs are engaged with the lugs, the tip of the tabs may be damaged. If the tabs are damaged, stop using the projector and consult your dealer for repair of the power cord.

Power indicator

The power indicator <ON(G)/STANDBY(R)> informs you the status of the power. Confirm the status of the power indicator <ON(G)/STANDBY(R)> before operating the projector.

Power indicator <ON(G)/STANDBY(R)>

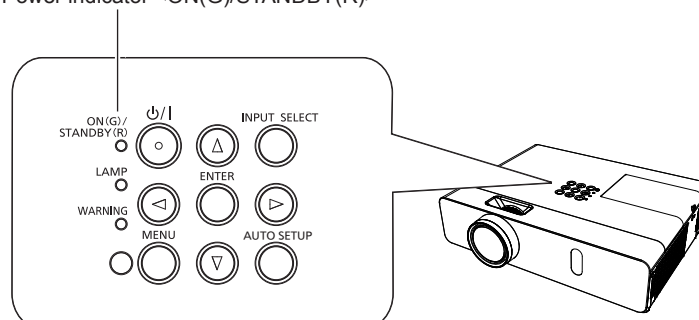

Indicator status		Status
Off		The power plug is not connected to the outlet.
Red	Lit	The power is switched off (in standby mode). The [PROJECTOR SETUP] menu → [ECO MANAGEMENT] → [STANDBY MODE] is set to [ECO].
	Blinking*1	The power is switched off (in standby mode). The [PROJECTOR SETUP] menu → [ECO MANAGEMENT] → [STANDBY MODE] is set to [NETWORK].
	Blinking*2	The power is switched off (in standby mode). The [PROJECTOR SETUP] menu → [ECO MANAGEMENT] → [STANDBY MODE] is set to [NORMAL].
Green	Lit	Projecting.
	Blinking*3	The luminous lamp is turned off. The [PROJECTOR SETUP] menu → [ECO MANAGEMENT] → [POWER MANAGEMENT] is set to [READY].
	Blinking*4	The projector is preparing to project. The projector will project image after a while.
Orange	Lit	The projector is preparing to be switched off. The power is switched off after a while. (Changes to the standby mode.)

*1 The indicator flashes in the cycle: 2.75 seconds (light) → 0.25 seconds (off) → 0.75 seconds (light) → 0.25 seconds (off)

*2 The indicator flashes in the cycle: 2.75 seconds (light) → 0.25 seconds (off)

*3 The indicator flashes in the cycle: 2.0 seconds (light) → 2.0 seconds (off)

*4 The indicator flashes in the cycle: 0.5 seconds (light) → 0.5 seconds (off)

Note

- While the power indicator <ON (G)/STANDBY (R)> lights in orange, the fan is running to cool the projector.
- For about 90 seconds after the projector is switched off, the luminous lamp does not light up even if the power is switched on. Turn on the power again after the power indicator <ON (G)/STANDBY (R)> lights/blinks in red.
- The projector consumes power even in standby mode (power indicator <ON (G)/STANDBY (R)> lights/blinks in red). Refer to “Power consumption” (➔ page 130) for the power consumption.

Powering on the projector

Before switching on the projector, make sure the projector and the external devices are correctly connected (➔ page 34) and the lens cap is removed beforehand.

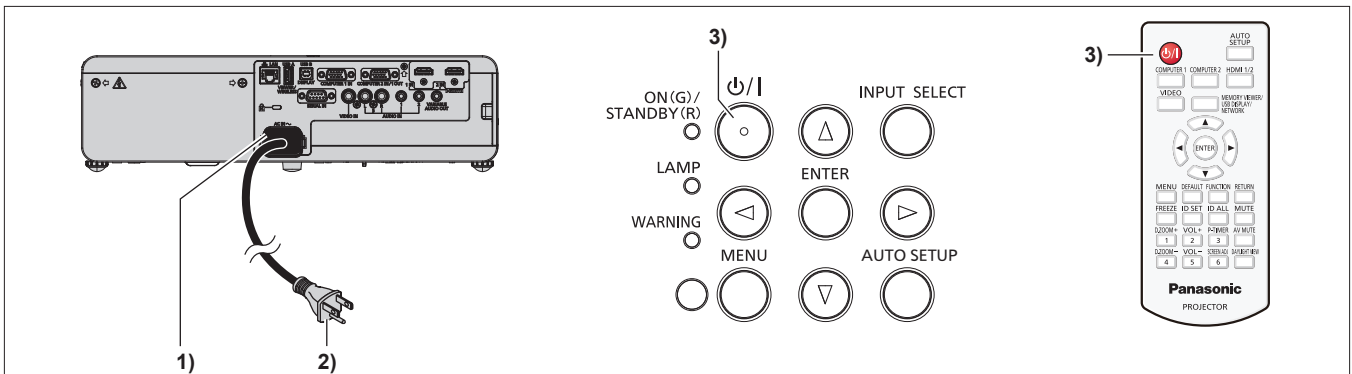

- 1) Connect the power cord to the projector body.**
- 2) Connect the power plug to an outlet.**
 - The power indicator <ON(G)/STANDBY(R)> lights or blinks, and the projector will enter the standby mode.
- 3) Press the power <⏻/|> button.**
 - The power indicator <ON(G)/STANDBY(R)> lights in green and the image is soon projected on the screen.

Attention

- Be sure to remove the lens cap before starting projection.

Note

- If the [PROJECTOR SETUP] menu → [ECO MANAGEMENT] → [STANDBY MODE] is set to [ECO], it may take approx. 10 seconds longer before the projector starts projecting after the power is turned on, compared with when [NORMAL] is set.

When the initial setting screen is displayed

When the projector is switched on for the first time after purchase as well as when [INITIALIZE ALL] in the [PROJECTOR SETUP] menu is executed, then the initial setting screen is displayed. Set them in accordance with circumstances.

In other occasions, you can change the settings by menu operations.

If you press the <MENU> button while the [INITIAL SETTING] screen is displayed, you can go back to the previous screen.

Same operation is available by pressing the <RETURN> button.

Note

- When the projector is used for the first time, in order to clearly display the menu screen, it may be necessary to adjust the focus ring and the zoom ring in the projection lens area of the projector (➔ page 24). For details, refer to “How to adjust the state of the image” (➔ page 44).

Initial setting (display language)

Select the language to show on the screen.

After completed the initial setting, you can change the display language from the [LANGUAGE] menu.

1) Press ▲▼◀▶ to select the display language.



2) Press the <ENTER> button to proceed to the initial setting.

Initial setting (installation setting)

If necessary, change the setting of each item.

PT-VW360

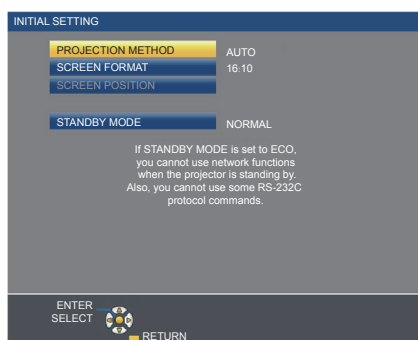

PT-VX430

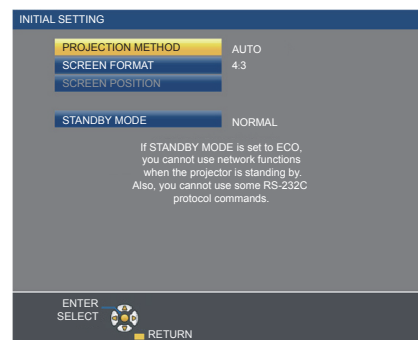

1) Press ▲▼ to select an item.

Item	Description	Page
[PROJECTION METHOD]	Set [PROJECTION METHOD] depending on the installation mode. After completing the initial setting, you can change the setting from the [PROJECTOR SETUP] menu → [PROJECTION METHOD].	30, 75
[SCREEN FORMAT]	Set the screen format (aspect ratio) and display position of the image. After completing the initial setting, you can change the settings of each item from the [DISPLAY OPTION] menu → [SCREEN SETTING].	70
[SCREEN POSITION]	Set the display position of the image. After completing the initial setting, you can change the settings of each item from the [DISPLAY OPTION] menu → [SCREEN SETTING].	70
[STANDBY MODE]	Set the operation mode during standby. The default setting is [NORMAL], which allows you to use the network function during standby. If you want to reduce the power consumption during standby, it can be set to [ECO]. If you want to keep the power consumption low during standby, and to perform operation of power-on via wired LAN with the Wake on LAN function, set to [NETWORK]. After the initial setting is completed, you can change the setting from the [PROJECTOR SETUP] menu → [ECO MANAGEMENT] → [STANDBY MODE].	77

- 2) Press ◀▶ to switch the setting.
 - When all settings are completed, proceed to Step 3).
- 3) Press the <ENTER> button.
 - Confirm the setting value and complete the initial setting.

Making adjustments and selections

It is recommended that images are projected continuously for at least 30 minutes before the focus is adjusted.

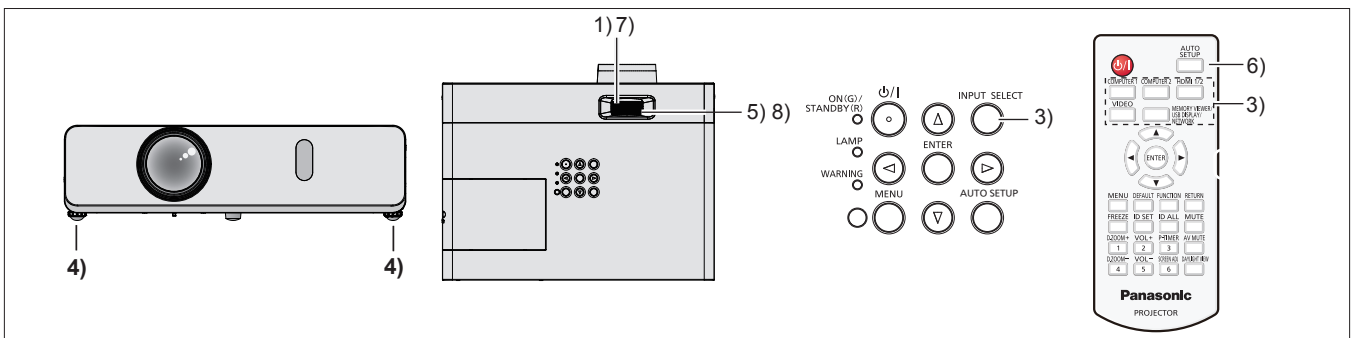

- 1) Roughly adjust the focus of the image with the focus ring. (➡ page 44)
- 2) Change the settings of the [PROJECTOR SETUP] menu → [PROJECTION METHOD] depending on the installation mode. (➡ page 30)
 - Refer to “Navigating through the menu” (➡ page 52) for the operation of the menu screen.
- 3) Press the <INPUT SELECT> button on the control panel or the input selection buttons (<COMPUTER 1>, <COMPUTER 2>, <HDMI 1/2>, <VIDEO>, <MEMORY VIEWER/USB DISPLAY/NETWORK>) on the remote control to select the input signal.
- 4) Adjust the front, back and sideway tilt of the projector with the adjustable feet. (➡ page 45)
- 5) Adjust the size of the image to match the screen with the zoom ring.
- 6) If the input signal is an analog RGB signal, press the <AUTO SETUP> button.
- 7) Adjust the focus again with the focus ring.
- 8) Adjust the size of the image to match the screen with the zoom ring again.

Note

- When the projector is switched on for the first time after purchase as well as when the [PROJECTOR SETUP] menu → [INITIALIZE ALL] is executed, the initial setting screen is displayed after projection starts. Refer to “When the initial setting screen is displayed” (➡ page 40).

Powering off the projector

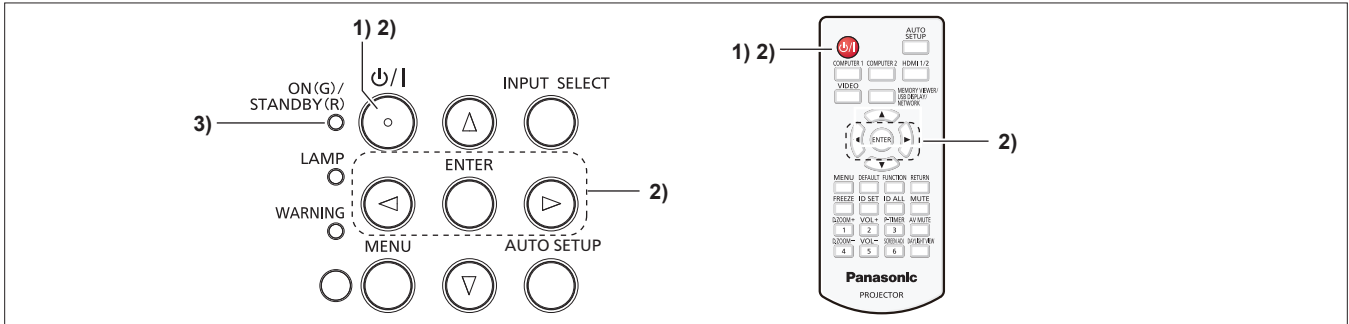

- 1) **Press the power <⏻/⏷> button.**
 - The [POWER OFF] confirmation screen is displayed.
- 2) **Press ◀▶ to select [OK], and press the <ENTER> button.
(Or press the power <⏻/⏷> button again.)**
 - Projection of the image will stop, and the power indicator <ON(G)/STANDBY(R)> lights in orange. (The fans keep running.)
- 3) **Wait until the power indicator <ON(G)/STANDBY(R)> on the projector lights or blinks in red.**
 - The projector enters standby mode when the power indicator <ON(G)/STANDBY(R)> lights or blinks in red.
- 4) **Disconnect the plug of the power cord from the outlet.**

Note

- While the power indicator <ON(G)/STANDBY(R)> is lighting in orange, the luminous lamp is being cooled down and the projector cannot be turned on. Wait until the power indicator <ON(G)/STANDBY(R)> starts lighting or blinking in red to turn on the projector again.
- When packing the projector for transportation and storage, please make sure that each indicator is off.
- **Even if the power is turned off by pressing the power <⏻/⏷> button, the projector consumes power if the power plug is connected to the outlet.**
When the [PROJECTOR SETUP] menu → [ECO MANAGEMENT] → [STANDBY MODE] is set to [ECO], use of some functions is restricted, but the power consumption during standby can be conserved.

Direct Power Off function

When the plug is disconnected from the outlet or the power is turned off by the circuit breaker in the ceiling mount case while the projection is going on, the projector can respond with direct power off function. Therefore, it is also safe in case a power outage occurs or the power cord is pulled out immediately after the projector is switched off.

Attention

- Do not disconnect the power cord from the wall outlet or turn off the circuit breaker switch in a short time (about 1 minute) after the luminous lamp is lit. Doing so may cause the luminous lamp to fail to light when you power on the projector next time, or result in premature deterioration of the luminous lamp.
- If you turn the power off with the direct power off function with the projector installed upside-down, or if you turn the projector upside-down after turning off the power using the direct power off function, do not put your hands or objects close to the air inlet (bottom) due to the back flow of heated air from the air inlet(bottom). It may cause burns, injuries or deformation.

Note

- When using the Direct Power Off function, you cannot restart the projector immediately after disconnecting the power cord from the wall outlet or turning off the breaker switch. The luminous lamp remains high temperature and needs to cool down, so it sometimes takes a longer time than usual for the luminous lamp to light up again.
- If the [PROJECTOR SETUP] menu → [INITIAL STARTUP] is set to [LAST MEMORY] and the projector was turned off by using the circuit breaker directly while projecting during the last time of use, the power indicator <ON(G)/STANDBY(R)> will light in green a while after the circuit breaker is turned on, and then projection of the image will start.

Projecting

Check the connections of the peripheral devices (➔ page 34) and connection of the power cord (➔ page 38) and switch on the power (➔ page 39) to start the projector. Select the image and adjust the state of the image.

Selecting the input signal

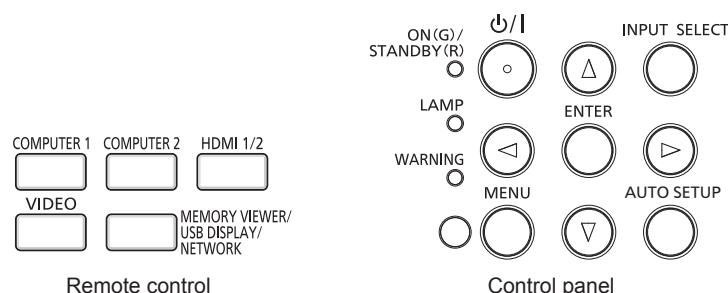

The input for projection can be switched. Method to switch the input is as follows.

- Press the input selection buttons on the remote control and directly specify the input to project.
- Press the <INPUT SELECT> button on the control panel to display the input selection screen and select the input to project from the list.

Switching the input directly via remote control

The input for projection can be switched directly by pressing the input selection button on the remote control.

1) Press the input selection (<COMPUTER 1>, <COMPUTER 2>, <HDMI 1/2>, <VIDEO>, <MEMORY VIEWER/USB DISPLAY/NETWORK>) buttons.

- Switches the input, and an input guide indicating the selected input terminal is temporarily displayed on the top right of the projection screen.

<COMPUTER 1>	Switches the input to COMPUTER 1. The image of the signal input in the <COMPUTER 1 IN> terminal is projected.
<COMPUTER 2>*1	Switches the input to COMPUTER 2. The image of the signal input in the <COMPUTER 2 IN/1 OUT> terminal is projected.
<HDMI 1/2>	Switches the input to HDMI 1 or HDMI 2. Switches to the other input when one input has already been selected. The image of the signal input to the <HDMI 1 IN> terminal or the <HDMI 2 IN> terminal is projected.
<VIDEO>	Switches the input to VIDEO. The image of the signal input to the <VIDEO IN> terminal is projected.
<MEMORY VIEWER/USB DISPLAY/NETWORK>	Switches the input to MEMORY VIEWER, USB DISPLAY or NETWORK. If one of the inputs has been selected, the input will switch each time you press the button.

*1 If the [PROJECTOR SETUP] menu → [COMPUTER2 SELECT] is set to [COMPUTER1 OUT], the COMPUTER2 input cannot be selected.

Attention

- Images may not be projected properly depending on the external device, or the Blu-ray disc or DVD disc, to be played back. Set the [PICTURE] menu → [RGB/YC_bC_r]/[RGB/YP_bP_r]. (➔ page 59)
- Confirm the aspect ratio of the projection screen and the image, and switch to an optimum aspect ratio from the [POSITION] menu → [ASPECT]. (➔ page 65)

Note

- Configure the [PROJECTOR SETUP] menu → [COMPUTER1 INPUT SETTING] to match the signal to be input to the <COMPUTER 1 IN> terminal.
- If inputting signals to the <COMPUTER 2 IN/1 OUT> terminal, please set the [PROJECTOR SETUP] menu → [COMPUTER2 SELECT] to [COMPUTER2 IN].
- If the MEMORY VIEWER input is selected, the still image stored in the USB memory can be projected using the Memory Viewer function. For details, please refer to "Memory Viewer function" (➔ page 90).
- If the projector has been connected to a computer with a USB converting cable and the USB DISPLAY input is selected, the computer screen and audio can be output using the USB display function. For details, please refer to "USB display function" (➔ page 92).

Switching the input by displaying the input guide

The input for projection can be selected by displaying the input guide with the control panel.

1) Press the <INPUT SELECT> button on the control panel.

- The input guide is displayed.

2) Press the <INPUT SELECT> button again.

- The input will switch each time you press the <INPUT SELECT> button.
- When the detailed input guide is displayed, you can select the input with the ▲▼◀▶ buttons on the remote control or on the control panel.

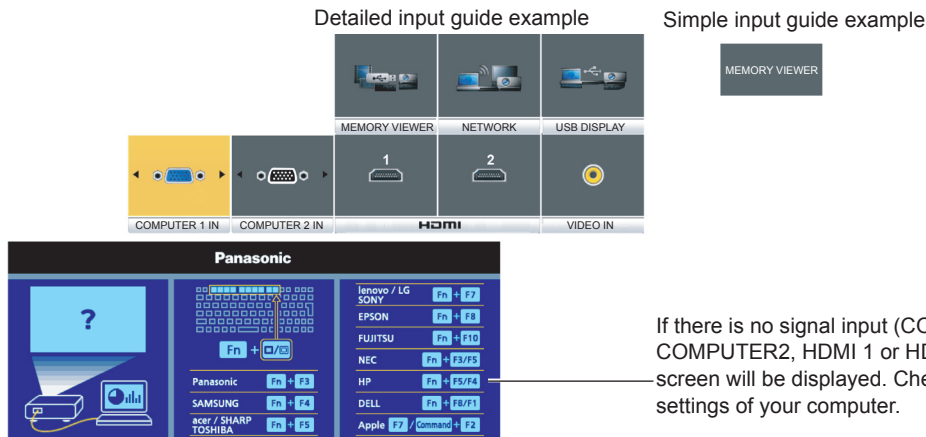

If there is no signal input (COMPUTER1, COMPUTER2, HDMI 1 or HDMI 2), this screen will be displayed. Check the output settings of your computer.

Attention

- You can switch the detailed/simple input guide by setting the [DISPLAY OPTION] menu → [ON-SCREEN DISPLAY] → [INPUT GUIDE].

How to adjust the state of the image

If the projected image or the position is not correct when the positioning of the projector and the screen is correctly installed, adjust the projection angle, focus and zoom.

1) Adjust the projection angle.

- Place the projector on a level surface and make its front side parallel to the screen surface so that the projection screen is rectangular.
- If the screen is tilted downward, extend the adjustable feet and adjust the projection screen so that the projected screen is rectangular.

For details, see “Adjusting adjustable feet” (➔ page 45).

2) Adjust the zoom and the focus.

- Rotate the zoom ring to adjust the projected image size to fit the screen.
- Rotate the focus ring to adjust the focus of the projected image.

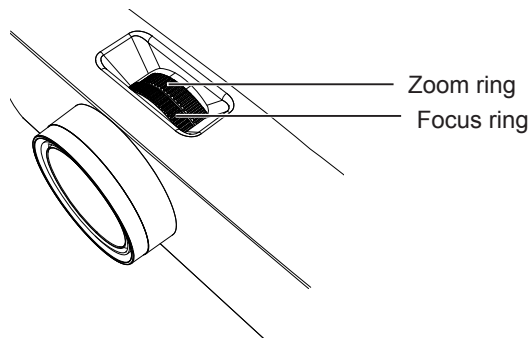

Note

- It is recommended that the images are projected continuously for at least 30 minutes before the focus is adjusted.
- When the focus is adjusted, the projection screen size also changes slightly. Depending on the image projection situation, repeat Steps 1) and 2) to adjust to the best projection condition.
- Adjust from the [POSITION] menu → [SCREEN ADJUSTMENT] (➔ page 61) when the projected image is distorted.

Adjusting adjustable feet

By pressing the adjustable feet lock with your finger, the adjustable feet lock is released and becomes free. It will be locked when you release the finger. Lift the front side of the projector while pressing the adjustable feet lock with your finger, and release your finger until the projection position is aligned. If fine adjustment of the projection position is necessary, adjust the adjustable feet by turning them. Turn the adjustable feet counterclockwise as shown in the figure to extend them. Also, turning them clockwise will return to the original status.

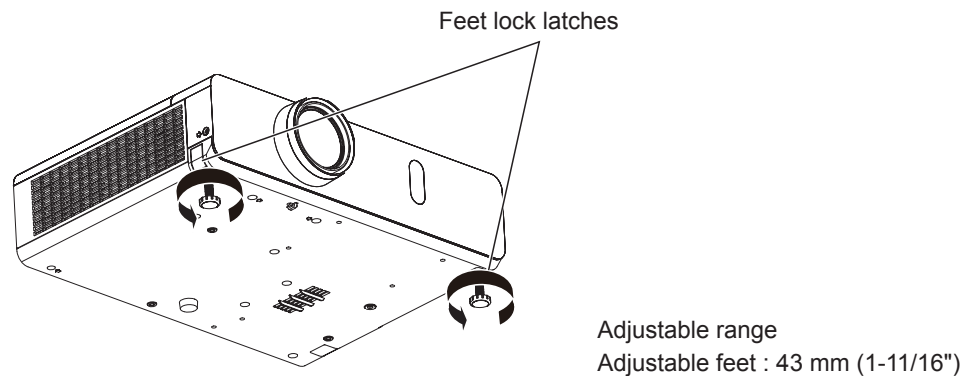

Attention

- Heated air is expelled from the air exhaust port. Do not touch the air exhaust port directly when adjusting the adjustable feet while using the projector. (➔ page 24)

Note

- When turning the adjustable feet clockwise, a click sound is heard when the adjustable feet changes to its minimum length.

Basic operations by using the remote control

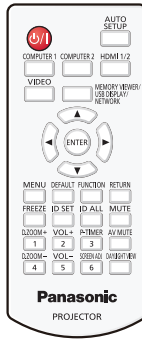

Using the AV mute function

If the projector is not used for a certain period of time during the meeting intermission, for example, it is possible to turn off the audio and image temporarily.

AV MUTE



- 1) **Press the <AV MUTE> button on the remote control.**
 - The audio and image turn off.
- 2) **Press the <AV MUTE> button again.**
 - The audio and image turn on.

Using the mute function

Audio can be temporarily turned off.

MUTE



- 1) **Press the <MUTE> button on the remote control.**
 - The audio turns off.
- 2) **Press the <MUTE> button again.**
 - The audio turns on.

Controlling the volume of the speaker

The volume of the built-in speaker or audio output can be adjusted.

VOL+



VOL-



buttons

- 1) **Press the <VOL +> button or <VOL -> button on the remote control.**
 - You can also operate with ◀▶ on the control panel.

<VOL +>	Increases the volume.
<VOL ->	Decreases the volume.

Using the freeze function

You can freeze the projected image and stop the sound temporarily, regardless of the playing condition of the external device.

FREEZE



button

1) Press the <FREEZE> button on the remote control.

- The video is paused and the audio is muted. [FREEZE] is displayed on the lower left of the screen during FREEZE.

2) Press the <FREEZE> button again.

- The video playback resumes and the audio is unmuted.

Using the auto setup function

The automatic setup function can be used to automatically adjust the resolution, clock phase, and image position when analog RGB signals consisting of bitmap images such as computer signals are being input. Supplying images with bright white borders at the edges and high-contrast black and white characters is recommended when the system is in automatic adjustment mode.

Avoid supplying images that include halftones or gradation, such as photographs and computer graphics.

AUTO
SETUP



button

1) Press the <AUTO SETUP> button on the remote control.

Note

- You can also use this function with the <AUTO SETUP> button on the control panel.
- The clock phase may shift even if it has completed without any incident. In such cases, adjust the [POSITION] menu → [CLOCK PHASE] (➡ page 64).
- Automatic adjustment may not work depending on the model of the computer and the input signal.
- Images may be disrupted for a few seconds during automatic adjustment, but it is not a malfunction.
- If you press any button on the remote control during the automatic adjustment, the automatic adjustment will be canceled.
- If the automatic setup function is used while moving images are being input, the adjustment may not be performed properly even for a signal that can use automatic setup.

Using the screen adjustment function

You can correct the distortion of the projected image that occurs when the projector is installed tilted or when the screen is tilted or curved.

SCREEN ADJ



button

1) Press the <SCREEN ADJ> button to display [KEYSTONE] individual adjustment screen.

Or press the <SCREEN ADJ> button again to display [CORNER CORRECTION] individual adjustment screen.

Or press the <SCREEN ADJ> button again to display [CURVED CORRECTION] individual adjustment screen.

- If you have adjusted values in any of the individual adjustment screen, the individual adjustment screen is not switched to the next screen even if you press the <SCREEN ADJ> button.

[KEYSTONE]	Adjusts when the trapezoid of the projected image is distorted.
[CORNER CORRECTION]	Adjusts when the four corners of the projected image are distorted.
[CURVED CORRECTION]	Adjusts when the linearity is not uniform or the projected image is curved distortion.

2) Press <ENTER> button to switch to the items to be adjusted.

- The items will switch each time you press the button.

3) Press ▲▼◀▶ to adjust the value.

Note

- One of [KEYSTONE], [CORNER CORRECTION] and [CURVED CORRECTION] setting value is valid.
- For more details, refer to the [POSITION] menu → [SCREEN ADJUSTMENT] (➡ page 61).

Using the digital zoom function

(Only for still image-based signals input)

You can enlarge the center area. You can also change the location of the area to be enlarged.

D.ZOOM+



D.ZOOM-



buttons

1) Press the <D.ZOOM +> button or < D.ZOOM -> button on the remote control.

- The moving screen is displayed. The moving screen is displayed when executing the remote control operation, and the [DIGITAL ZOOM] individual adjustment screen is not displayed.
- The [DIGITAL ZOOM] individual adjustment screen is displayed when executing the menu operation. For details, refer to [DISPLAY OPTION] → [OTHER FUNCTIONS] (➡ page 73).

2) Press the following buttons to move the location of the image or adjust the magnification.

Operation menu/Buttons	Operation	Adjustment
<p>Moving screen</p> <p>Remote control operation button</p>	Press the ▲ button.	Moves the image to the bottom.
	Press the ▼ button.	Moves the image to the top.
	Press the ◀ button.	Moves the image to the right.
	Press the ▶ button.	Moves the image to the left.
	Press the <D.ZOOM +> button.	Increases magnification.
	Press the <D.ZOOM -> button.	Decreases magnification.

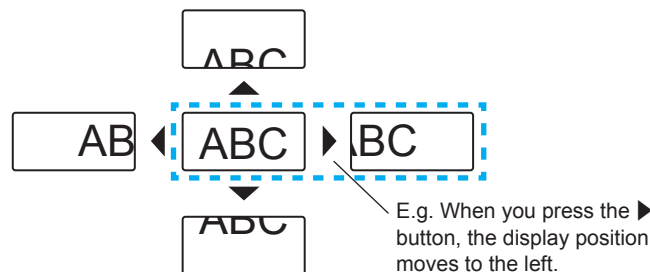

Note

- The magnification is not displayed in the moving screen.
- The digital zoom function is canceled if the input signal changes during a digital zoom.
- During a digital zoom, the freeze function is disabled.
- The digital zoom function may not work properly for some still image-based signals.

Using the presentation timer function

You can operate the presentation timer function.

Presentations, etc. can be performed while checking the elapsed time or time remaining in the preset time.

P-TIMER



button

1) Press the <P-TIMER> button on the remote control.

- The count is started.
- The elapsed time or the remaining time is displayed at the bottom right of the projected image.

2) Press the <P-TIMER> button again.

- The count is stopped.

3) Press the <P-TIMER> button again.

- The count is resumed.

Note

- Pressing the <P-TIMER> button for at least 3 seconds to release the P-TIMER function.
- For details, please refer to the [DISPLAY OPTION] menu → [P-TIMER] (➔ page 72).

Using the FUNCTION button

Some frequently used menu items can be assigned to the <FUNCTION> button on the remote control so that it can be used as an shortcut button.

FUNCTION



button

1) Press the <FUNCTION> button on the remote control.

To assign functions to the <FUNCTION> button

1) Press the <MENU> button on the control panel or the remote control to display the menu items (main menu, sub-menu or details menu) you want to assign.

- Refer to “Navigating through the menu” (➔ page 52) for the operation of the menu.

2) Press and hold the <FUNCTION> button for 3 seconds or more.

Note

- After settings have been completed, the assigned menu item (main menu, sub-menu or details menu) will be displayed in [ASSIGNED FUNCTION] of the operation guide under the menu.
- Perform the [PROJECTOR SETUP] menu → [FUNCTION BUTTON] (➔ page 78) when deallocating functions.

Using the Daylight View function

The Daylight View function improves the vividness of the image even if it is projected under a bright light.

DAYLIGHT VIEW



button

1) Press the <DAYLIGHT VIEW> button on the remote control.

- It will switch each time you press the button, [ON] → [OFF] → [AUTO] → [ON]...

Note

- For details, please refer to the [PICTURE] menu → [DAYLIGHT VIEW] (➔ page 58).

Setting the ID number of the remote control

When you use the system with multiple projectors, you can operate all the projectors simultaneously or each projector individually by using single remote control, if unique ID number is assigned to each projector.

After setting the ID number of the projector, set the same ID number to the remote control.

The factory default ID number of the projector is set to [ALL]. When using a single projector, press the <ID ALL> button on the remote control. Also, you can control a projector by pressing the <ID ALL> button on the remote control even if you do not know the projector ID.

ID SET ID ALL



buttons

1) Press the <ID SET> button on the remote control.

2) Within 5 seconds, press the one-digit ID number set on the projector using the number (<1> - <6>) buttons.

- If you press the <ID ALL> button, you can control the projectors regardless of the ID number setting of the projector.

Attention

- Since the ID number of the remote control can be set without the projector, do not press the <ID SET> button on the remote control carelessly. If the <ID SET> button is pressed and no number (<1> - <6>) buttons are pressed within 5 seconds, the ID number returns to its original value before the <ID SET> button was pressed.
- The ID number set on the remote control will be stored unless it is set again. However, it will be erased if the remote control is left with dead batteries. Set the same ID number again when the batteries are replaced.

Note

- Set the ID number of the projector from the [PROJECTOR SETUP] menu → [PROJECTOR ID]. (▶ page 75)

Chapter 4 Settings

This chapter describes the settings and adjustments you can make using the on-screen menu.

Menu navigation

The on-screen menu (Menu) is used to perform various settings and adjustments of the projector.

Navigating through the menu

Operating procedure

MENU
 button

- 1) Press the <MENU> button on the remote control or the control panel.
 - The menu screen appears.



- 2) Press ▲▼ to select an item from the main menu.
 - The selected item is highlighted in yellow.

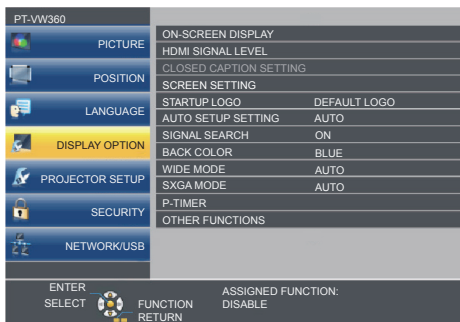

- 3) Press the <ENTER> button.
 - The sub-menu is displayed, and sub-menu items become selectable.

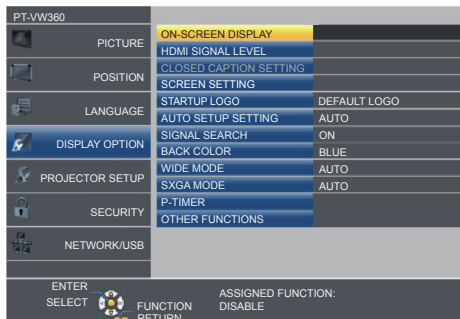

- 4) Press ▲▼ to select the desired sub-menu item, press ◀▶ or the <ENTER> button to set or adjust settings.
 - Some items will switch in order as follows each time you press ◀▶.

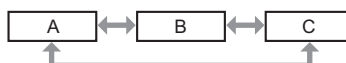

- For some items, press ◀▶ to display an individual adjustment screen with a bar scale as shown below.



Note

- Pressing the <MENU> button or <RETURN> button while the menu screen is displayed returns to the previous menu.
- Some items may not be adjusted or used for certain signal formats to be input to the projector. The menu items that cannot be adjusted or used are shown in gray characters, and they cannot be selected. [DIGITAL CINEMA REALITY] and [FRAME LOCK] may not be displayed depending on the input signal.
- Some items can be adjusted even if signals are not input.
- Individual adjustment screen is cleared automatically if no operation is performed for approximately 5 seconds.
- For menu items, refer to “Main menu” (➔ page 53) and “Sub-menu” (➔ page 54).

Resetting adjustment values to the factory default

If the <DEFAULT> button on the remote control is pressed, the values adjusted in the menu items are restored to the factory default settings.

DEFAULT



button

- 1) Press the <DEFAULT> button on the remote control.







Note

- You cannot reset all the settings to the factory default at a time.
- To reset all the settings adjusted in the sub-menu item to the factory default one at a time, execute the [PROJECTOR SETUP] menu → [INITIALIZE ALL] (➔ page 81).
- Some items cannot be reset by pressing the <DEFAULT> button. Adjust each item manually.

Main menu

The main menu consists of the following 7 menu items.

When a main menu item is selected, the cursor moves to its sub menu.

	Main-menu item	Page
	[PICTURE]	56
	[POSITION]	61
	[LANGUAGE]	67
	[DISPLAY OPTION]	68
	[PROJECTOR SETUP]	74
	[SECURITY]	82
	[NETWORK/USB]	85

Sub-menu

You can set and adjust the items in each submenu.

[PICTURE]

Sub-menu item	Factory default	Page
[PICTURE MODE]	[STANDARD]	56
[CONTRAST]	[0]	56
[BRIGHTNESS]	[0]	56
[COLOR]* ¹	[0]	56
[TINT]* ¹	[0]	57
[SHARPNESS]	[+8]	57
[COLOR TEMPERATURE]	[DEFAULT]	57
[IRIS]	[ON]	57
[ADVANCED MENU]	-	58
[DAYLIGHT VIEW]	[ON]	58
[DIGITAL CINEMA REALITY]* ¹	[ON]	59
[NOISE REDUCTION]* ²	[OFF]	59
[TV-SYSTEM]* ²	[AUTO]	59
[RGB/Y _B P _R]/[RGB/YC _B C _R]* ³	[AUTO]	59

*1 Only for movie-based signals.

*2 Only when the <VIDEO IN> terminal is selected.

*3 Only when the <COMPUTER 1 IN>/<COMPUTER 2 IN/ 1 OUT>/<HDMI 1 IN>/<HDMI 2 IN>terminal is selected.

Note

- The factory default settings may vary depending on the picture mode.

[POSITION]

Sub-menu item	Factory default	Page
[REALTIME KEYSTONE]	[ON]	61
[SCREEN ADJUSTMENT]	-	61
[SHIFT]	-	63
[DOT CLOCK]* ¹	[0]	64
[CLOCK PHASE]* ¹	[0]	64
[OVER SCAN]	-	65
[ASPECT]	- * ²	65
[FRAME LOCK]* ¹	[ON]	66

*1 Only for still image signals.

*2 It depends on the input signal.

[LANGUAGE]

Details (➔ page 67)

[DISPLAY OPTION]

Sub-menu item	Factory default	Page
[ON-SCREEN DISPLAY]	-	68
[HDMI SIGNAL LEVEL]	[AUTO]	69
[CLOSED CAPTION SETTING]	-	69
[SCREEN SETTING]	-	70
[STARTUP LOGO]	[DEFAULT LOGO]	70
[AUTO SETUP SETTING]	[AUTO]	71
[SIGNAL SEARCH]	[ON]	71
[BACK COLOR]	[BLUE]	71
[WIDE MODE]	-	71
[SXGA MODE]	-	71
[P-TIMER]	-	72
[OTHER FUNCTIONS]	-	73

[PROJECTOR SETUP] 

Sub-menu item	Factory default	Page
[STATUS]	-	74
[COMPUTER1 INPUT SETTING]	[RGB/YP _B P _R]	74
[COMPUTER2 SELECT]	[COMPUTER2 IN]	74
[PROJECTOR ID]	[ALL]	75
[INITIAL START UP]	[LAST MEMORY]	75
[PROJECTION METHOD]	[AUTO]	75
[HIGH ALTITUDE MODE]	[OFF]	75
[LAMP POWER]	[NORMAL]	76
[ECO MANAGEMENT]	-	76
[EMULATE]	[DEFAULT]	78
[FUNCTION BUTTON]	-	78
[AUDIO SETTING]	-	78
[TEST PATTERN]	-	80
[FILTER COUNTER]	-	80
[INITIALIZE ALL]	-	81

[SECURITY] 

Sub-menu item	Factory Default	Page
[PASSWORD]	[OFF]	82
[PASSWORD CHANGE]	-	82
[TEXT DISPLAY]	[OFF]	82
[TEXT CHANGE]	-	83
[MENU LOCK]	[OFF]	83
[MENU LOCK PASSWORD]	-	83
[CONTROL DEVICE SETUP]	-	83

[NETWORK/USB] 

Sub-menu item	Factory default	Page
[WIRED LAN]	-	85
[NAME CHANGE]	-	85
[NETWORK CONTROL]	[ON]	86
[AMX D.D.]	[OFF]	86
[Crestron Connected(TM)]	[OFF]	86
[MEMORY VIEWER LIGHT]	-	86
[STATUS]	-	88
[INITIALIZE]	-	88

Note

- Some items may not be adjusted or used for certain signal formats to be input to the projector.
The menu items that cannot be adjusted or used are shown in gray characters, and they cannot be selected.
- Sub-menu items and factory default settings differ depending on the selected input.

[PICTURE] menu

On the menu screen, select [PICTURE] from the main menu, and select an item from the sub-menu. Refer to “Navigating through the menu” (⇒ page 52) for the operation of the menu screen.

[PICTURE MODE]

You can switch to the desired picture mode suitable for the image source and the environment in which the projector is used.

- 1) Press ▲▼ to select [PICTURE MODE].
- 2) Press ◀▶ or the <ENTER> button.
 - The [PICTURE MODE] individual adjustment screen is displayed.
- 3) Press ◀▶ to switch the item.
 - The items will switch each time you press the button.

[STANDARD]	The picture becomes suitable for moving images in general.
[DYNAMIC]	The light output is maximized for use in bright areas.
[BLACKBOARD]	The picture becomes suitable for projecting on a black board.
[WHITE BOARD]	The picture becomes suitable for projecting on a white board.
[CINEMA]*1	The picture becomes suitable for movie sources.
[NATURAL]*2	The picture becomes suitable for use in low-light areas.

*1 Only for the movie-based signals.

*2 Only for the still image signals.

[CONTRAST]

You can adjust the contrast of the colors.

- 1) Press ▲▼ to select [CONTRAST].
- 2) Press ◀▶ or the <ENTER> button.
 - The [CONTRAST] individual adjustment screen is displayed.
- 3) Press ◀▶ to adjust the level.

Operation	Adjustment	Adjustment range
Press the ▶ button.	Brightens the screen and makes the color of image deeper.	-32 ~ +32
Press the ◀ button.	Darkens the screen and makes the color of image lighter.	

Attention

- Adjust [BRIGHTNESS] first when you need to adjust [BRIGHTNESS] and [CONTRAST].

[BRIGHTNESS]

You can adjust the dark (black) part of the projected image.

- 1) Press ▲▼ to select [BRIGHTNESS].
- 2) Press ◀▶ or the <ENTER> button.
 - The [BRIGHTNESS] individual adjustment screen is displayed.
- 3) Press ◀▶ to adjust the level.

Operation	Adjustment	Adjustment range
Press the ▶ button.	Increases the brightness of the dark (black) parts of the screen.	-32 ~ +32
Press the ◀ button.	Reduces the brightness of the dark (black) parts of the screen.	

[COLOR]

(Only for movie-based signal input)

You can adjust the color saturation of the projected image.

- 1) Press ▲▼ to select [COLOR].

- 2) Press ◀▶ or the <ENTER> button.
 - The [COLOR] individual adjustment screen is displayed.
- 3) Press ◀▶ to adjust the level.

Operation	Adjustment	Adjustment range
Press the ▶ button.	Deepens colors.	-32 ~ +32
Press the ◀ button.	Weakens colors.	

[TINT]

(Only for movie-based signal input except PAL / PAL-M / PAL-N / PAL60 / SECAM)
 You can adjust the skin tone in the projected image.

- 1) Press ▲▼ to select [TINT].
- 2) Press ◀▶ or the <ENTER> button.
 - The [TINT] individual adjustment screen is displayed.
- 3) Press ◀▶ to adjust the level.

Operation	Adjustment	Adjustment range
Press the ▶ button.	Adjusts skin tone toward greenish color.	-32 ~ +32
Press the ◀ button.	Adjusts skin tone toward reddish purple.	

[SHARPNESS]

You can adjust the sharpness of the projected image.

- 1) Press ▲▼ to select [SHARPNESS].
- 2) Press ◀▶ or the <ENTER> button.
 - The [SHARPNESS] individual adjustment screen is displayed.
- 3) Press ◀▶ to adjust the level.

Operation	Adjustment	Adjustment range
Press the ▶ button.	Contours become sharper.	0 ~ +15
Press the ◀ button.	Contours become softer.	

Note

- [SHARPNESS] will be invalid when [DAYLIGHT VIEW] is set to [AUTO] or [ON].

[COLOR TEMPERATURE]

You can switch the color temperature if the white areas of the projected image are bluish or reddish.

- 1) Press ▲▼ to select [COLOR TEMPERATURE].
- 2) Press ◀▶ or the <ENTER> button.
 - The [COLOR TEMPERATURE] individual adjustment screen is displayed.
- 3) Press ◀▶ to switch the item.
 - The items will switch each time you press the button.

[DEFAULT]	Factory default setting.
[HIGH]	Becomes a bluish image. Select this when the white areas of the projected image are reddish.
[LOW]	Becomes a reddish image. Select this when the white areas of the projected image are bluish.

[IRIS]

Aperture correction and signal compensation are performed automatically based on the image to result in an image of optimum contrast.

- 1) Press ▲▼ to select [IRIS].

- 2) Press ◀▶ or the <ENTER> button.
 - The [IRIS] individual adjustment screen is displayed.
- 3) Press ◀▶ to switch the item.
 - The items will switch each time you press the button.

[OFF]	No correction.
[ON]	Corrects the aperture.

[ADVANCED MENU]

You can perform more advanced image adjustment.

- 1) Press ▲▼ to select [ADVANCED MENU].
- 2) Press the <ENTER> button.
 - The [ADVANCED MENU] screen is displayed.
- 3) Press ▲▼ to select one item to adjust.
- 4) Press ◀▶ or the <ENTER> button.
 - The individual adjustment screen of items are displayed.
- 5) Press ◀▶ to adjust the value.

Items	Operation	Adjustment	Adjustment range
[CONTRAST R]	Press the ▶ button.	Emphasizes red in highlight areas.	-32 ~ +32
	Press the ◀ button.	Deemphasizes red in highlight areas.	
[CONTRAST G]	Press the ▶ button.	Emphasizes green in highlight areas.	-32 ~ +32
	Press the ◀ button.	Deemphasizes green in highlight areas.	
[CONTRAST B]	Press the ▶ button.	Emphasizes blue in highlight areas.	-32 ~ +32
	Press the ◀ button.	Deemphasizes blue in highlight areas.	
[BRIGHTNESS R]	Press the ▶ button.	Emphasizes red in shadow areas.	-32 ~ +32
	Press the ◀ button.	Deemphasizes red in shadow areas.	
[BRIGHTNESS G]	Press the ▶ button.	Emphasizes green in shadow areas.	-32 ~ +32
	Press the ◀ button.	Deemphasizes green in shadow areas.	
[BRIGHTNESS B]	Press the ▶ button.	Emphasizes blue in shadow areas.	-32 ~ +32
	Press the ◀ button.	Deemphasizes blue in shadow areas.	

[DAYLIGHT VIEW]

You can correct the image to the optimal vividness even if it is projected under a bright light.

- 1) Press ▲▼ to select [DAYLIGHT VIEW].
- 2) Press ◀▶ or the <ENTER> button.
 - The [DAYLIGHT VIEW] individual adjustment screen is displayed.
- 3) Press ◀▶ to switch the item.
 - The items will switch each time you press the button.

[ON]	Corrects the vividness of the image.
[OFF]	No correction.
[AUTO]	Detects the brightness of the installation environment with the luminance sensor, and automatically corrects the vividness of the image.

Note

- [DAYLIGHT VIEW] cannot be set to [AUTO] when the [PROJECTOR SETUP] menu → [PROJECTION METHOD] is set to [REAR/DESK] or [REAR/CEILING].
- The luminance may not be detected correctly when an object is placed on top of the projector, blocking the luminance sensor. In such a case, this function may not operate properly even if it is set to [AUTO].

[DIGITAL CINEMA REALITY]

You can increase the vertical resolution and enhance the image quality by performing cinema processing when the PAL (or SECAM) 576i signal, the NTSC 480i signal, and 1080/50i, 1080/60i are input.

- 1) Press ▲▼ to select [DIGITAL CINEMA REALITY].
- 2) Press ◀▶ or the <ENTER> button.
 - The [DIGITAL CINEMA REALITY] individual adjustment screen is displayed.
- 3) Press ◀▶ to switch the item.
 - The items will switch each time you press the button.

[ON]	Performs cinema processing.
[OFF]	Performs no cinema processing.

[NOISE REDUCTION]

(Only for VIDEO signal input)

You can reduce noises when the input image is degraded and noise is occurring in the image signal.

- 1) Press ▲▼ to select [NOISE REDUCTION].
- 2) Press ◀▶ or the <ENTER> button.
 - The [NOISE REDUCTION] individual adjustment screen is displayed.
- 3) Press ◀▶ to switch the item.
 - The items will switch each time you press the button.

[OFF]	Disables [NOISE REDUCTION].
[ON]	Enables [NOISE REDUCTION].

Attention

- When this is set for an input signal with less noise, the image may look different from what it originally was. In such a case, set it to [OFF].

[TV-SYSTEM]

(Only for VIDEO signal input)

The projector will automatically detect the input signal, but you can set the color system manually when an unstable signal is input. Set the color system matching the input signal.

- 1) Press ▲▼ to select [TV-SYSTEM].
- 2) Press ◀▶ or the <ENTER> button.
 - The [TV-SYSTEM] individual adjustment screen is displayed.
- 3) Press ◀▶ to select the color system.
 - The items will switch each time you press the button.
 - Select among [AUTO], [NTSC], [NTSC4.43], [PAL], [PAL-M], [PAL-N], [PAL60] and [SECAM].
 - Set it to [AUTO] normally. (Setting [AUTO] will automatically select [NTSC], [NTSC4.43], [PAL], [PAL-M], [PAL-N], [SECAM] or [PAL60].)

[RGB/YP_BP_R] / [RGB/YC_BC_R]

The projector will automatically detect the input signal, but you can set the system format manually when an unstable signal is input. Set the system format matching the input signal.

- 1) Press ▲▼ to select [RGB/YP_BP_R] or [RGB/YC_BC_R].
- 2) Press ◀▶ or the <ENTER> button.
 - The [RGB/YP_BP_R] or [RGB/YC_BC_R] individual adjustment screen is displayed.

3) Press ◀▶ to switch the item.

- The items will switch each time you press the button.
- Normally it is set to [AUTO]. If it cannot project properly with [AUTO], set it to [RGB], [Y_BC_R] or [Y_PP_R] according to the input signal.

[AUTO]	[RGB], [Y _P P _R] or [Y _B C _R] is selected automatically.
[RGB]	Select it for RGB signal input.
[Y _P P _R]	Select it for Y _P P _R signal input.
[Y _B C _R]	Select it for Y _B C _R signal input.

When COMPUTER 1 / COMPUTER 2 input is selected

- **For 525i (480i), 625i (576i), 525p (480p) and 625p (576p) input**
Select [AUTO], [RGB] or [Y_BC_R].
- **For other movie-based signal input**
Select [AUTO], [RGB] or [Y_PP_R].

When HDMI 1 / HDMI 2 input is selected

- **For 525p (480p) and 625p (576p) input**
Select [AUTO], [RGB] or [Y_BC_R].
- **For other movie-based signal input**
Select [AUTO], [RGB] or [Y_PP_R].

Note

- Refer to "List of compatible signals" (➔ page 128) for the signal details.
- The signal selection may not function properly depending on connected devices.

[POSITION] menu

On the menu screen, select [POSITION] from the main menu, and select an item from the sub-menu. Refer to “Navigating through the menu” (➔ page 52) for the operation of the menu screen.

[REALTIME KEYSTONE]

The projector can correct the vertical trapezoidal distortion automatically when the projector is installed tilted.

- 1) Press ▲▼ to select [REALTIME KEYSTONE].
- 2) Press ◀▶ or the <ENTER> button.
 - [REALTIME KEYSTONE] individual adjustment screen is displayed.
- 3) Press ◀▶ to switch the item.

[ON]	Enables the automatic realtime keystone correction.
[OFF]	Disables the automatic realtime keystone correction.

Note

- Depending on the installation situation, the trapezoidal distortion may not be able to be fully corrected. In this case, perform the adjustment in the [POSITION] menu → [SCREEN ADJUSTMENT].
- [REALTIME KEYSTONE] cannot be set when the [PROJECTOR SETUP] menu → [PROJECTION METHOD] is set to [FRONT/CEILING] or [REAR/CEILING].

[SCREEN ADJUSTMENT]

Correct the distortion when the projector is installed as tilted or the screen is tilted or curved.

- 1) Press ▲▼ to select [SCREEN ADJUSTMENT].
- 2) Press the <ENTER> button.
 - The [SCREEN ADJUSTMENT] screen is displayed.
- 3) Press ▲▼ to select one item to adjust.

[KEYSTONE]	Adjusts when the projected image is distorted as trapezoid.
[CORNER CORRECTION]	Adjusts when the four corners of the projected image are distorted.
[CURVED CORRECTION]	Adjusts when the projected image is curved distortion.

- 4) Press the <ENTER> button.
 - The [KEYSTONE] screen, [CORNER CORRECTION] screen or the [CURVED CORRECTION] screen is displayed.

Note

- Only one item of [KEYSTONE], [CORNER CORRECTION] and [CURVED CORRECTION] can be enabled. If you perform the setting of [KEYSTONE], [CORNER CORRECTION] or [CURVED CORRECTION] and then perform the setting of the other items, the value of the previous items will be reset.
- The image quality will deteriorate as the correction amount of [SCREEN ADJUSTMENT] increases, making focusing difficult. Install the projector so that the correction amount is as small as possible.
- When adjustments are performed with [SCREEN ADJUSTMENT], the image size also changes.

Setting [KEYSTONE]

- 1) Press ▲▼ to select [SCREEN ADJUSTMENT].
- 2) Press the <ENTER> button.
 - The [SCREEN ADJUSTMENT] screen is displayed.
- 3) Press ▲▼ to select [KEYSTONE].
- 4) Press the <ENTER> button.
 - The [KEYSTONE] individual adjustment screen is displayed.

5) Press ▲▼◀▶ to adjust the item.

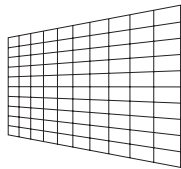
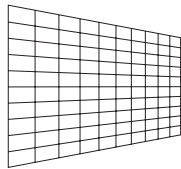
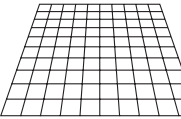
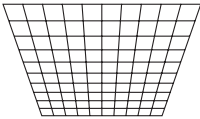
Items	Operation	Adjustment	Adjustment range	
[H]	Press the ◀ button.	Left side will be smaller.	 	-70 ~ +70
	Press the ▶ button.	Right side will be smaller.		
[V]	Press the ▲ button.	Upper will be smaller.	 	-70 ~ +70
	Press the ▼ button.	Lower will be smaller.		

Note

- Pressing the <ENTER> button while the individual adjustment screen is displayed can switch to the individual adjustment screen of other items.
- Correction up to ±35° for the tilt in both vertical and horizontal direction is available for adjustments with [KEystone]. However, the image quality will degrade and it will get harder to focus with more correction. Install the projector so that the correction will be as small as possible.

Setting [CORNER CORRECTION]

- 1) Press ▲▼ to select [SCREEN ADJUSTMENT].
- 2) Press the <ENTER> button.
 - The [SCREEN ADJUSTMENT] screen is displayed.
- 3) Press ▲▼ to select [CORNER CORRECTION].
- 4) Press the <ENTER> button.
 - The [CORNER CORRECTION] screen is displayed.
- 5) Press ▲▼ to select the item to adjust. Then press the <ENTER> button.
 - The individual adjustment screen of the selected item is displayed.
- 6) Press ▲▼◀▶ to adjust.

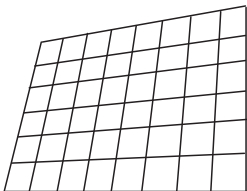
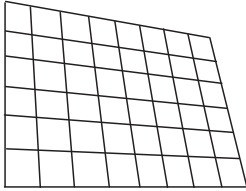
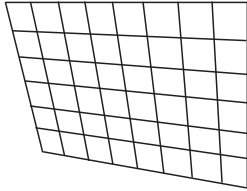
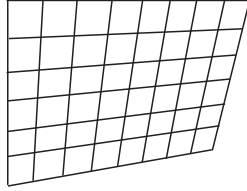
[CORNER CORRECTION]			
[UPPER LEFT]	[UPPER RIGHT]	[LOWER LEFT]	[LOWER RIGHT]
			

Note

- When the [CORNER CORRECTION] individual adjustment screen is displaying, the individual adjustment screen of the next corner can also be displayed by pressing the <ENTER> button.
- Depending on the correction amount, the image aspect ratio may change.

Setting [CURVED CORRECTION]

- 1) Press ▲▼ to select [SCREEN ADJUSTMENT].
- 2) Press the <ENTER> button.
 - The [SCREEN ADJUSTMENT] screen is displayed.

- 3) Press ▲▼ to select [CURVED CORRECTION].
- 4) Press the <ENTER> button.
 - The [CURVED CORRECTION] screen is displayed.
- 5) Press ▲▼ to select one item to adjust.

[KEystone]	Adjusts when the trapezoid of the projected image is distorted.
[ARC]	Adjusts when the radian of the projected image is distorted.



- 6) Press the <ENTER> button.
 - The [KEystone] or the [ARC] individual adjustment screen is displayed.

Adjusting [KEystone]

- 1) Press ▲▼◀▶ to adjust.
 - For details, please refer to [KEystone] in [SCREEN ADJUSTMENT] menu. (➡ page 61)

Adjusting [ARC]

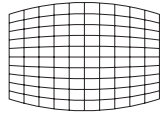
- 1) Press ▲▼◀▶ to adjust.

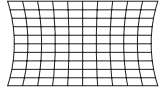
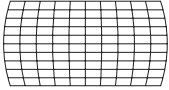
Items	Operation	Adjustment		
[H]	Press the ◀ button.	The top and the bottom of horizontal line will be bulge.		
	Press the ▶ button.	The top and the bottom of horizontal line will be dent.		
[V]	Press the ▲ button.	The left and the right of vertical line will be dent.		
	Press the ▼ button.	The left and the right of vertical line will be bulge.		

Note

- Pressing the <ENTER> button while the individual adjustment screen is displayed can switch to the individual adjustment screen of other items.

[SHIFT]

(Only for RGB signal and YC_BC_R/YP_BP_R signal input)

Move the image position vertically or horizontally if the image position projected on the screen is shifted even when the relative position of the projector and the screen is installed correctly.

- 1) Press ▲▼ to select [SHIFT].
- 2) Press the <ENTER> button.
 - The [SHIFT] screen is displayed.
- 3) Press ▲▼◀▶ to adjust the position.

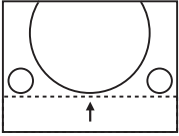
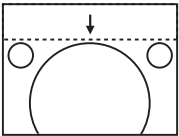
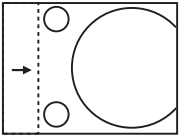
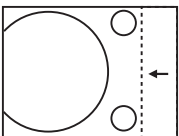
Orientation	Operation	Adjustment	
Vertical (up and down) adjustment	Press the ▲ button.	The image position moves up.	
	Press the ▼ button.	The image position moves down.	
Horizontal (right and left) adjustment	Press the ► button.	The image position moves to the right.	
	Press the ◀ button.	The image position moves to the left.	

Note

- Depending on the input signal, if the adjustment of [SHIFT] exceeds the effective adjustment range of the input signal, the position of the image cannot be changed. Please adjust [SHIFT] within an effective adjustment range.

[DOT CLOCK]

(Only for COMPUTER1 input / COMPUTER2 input)

Use this function to adjust and minimize the effect of interference caused by projection of patterns consisting of vertical stripes.

The projection of the striped pattern may cause cyclic patterns (noise). Adjust so that the amount of interference is at a minimum.

- Press ▲▼ to select [DOT CLOCK].
- Press ◀▶ or the <ENTER> button.
 - The [DOT CLOCK] individual adjustment screen is displayed.
- Press ◀▶ to adjust the value.
 - The adjustment values are [-32] to [+32].

Attention

- Set it before adjusting [CLOCK PHASE].

Note

- When G-SYNC and Y/C signals are input, [DOT CLOCK] cannot be adjusted.
- Depending on the input signal, if the [DOT CLOCK] is adjusted to exceed the valid adjustment range of the input signal, the image position does not change. Please adjust the [DOT CLOCK] within the effective adjustment range.

[CLOCK PHASE]

(Only for COMPUTER1 input / COMPUTER2 input)

You can adjust to achieve an optimal image when there is a flickering image or smeared outlines.

- Press ▲▼ to select [CLOCK PHASE].
- Press ◀▶ or the <ENTER> button.
 - The [CLOCK PHASE] individual adjustment screen is displayed.

3) Press ◀▶ to adjust the value.

- The adjustment values will change between [-16] to [+16]. Adjust so that the amount of interference is at a minimum.

Note

- Certain signals may not be adjustable.
- Optimal value may not be achieved if the output from the input computer is unstable.
- To project a signal with dot clock frequency with 162 MHz or higher, noise may not disappear even if [CLOCK PHASE] is adjusted.

[OVER SCAN]

(Only for movie-based signal input)

Use this function when characters or pictures are cropped near the periphery of the projected image.

1) Press ▲▼ to select [OVER SCAN].

2) Press ◀▶ or the <ENTER> button.

- The [OVER SCAN] individual adjustment screen is displayed.

3) Press ◀▶ to adjust the level.

- The adjustment values are [0] to [+3].

[ASPECT]

You can switch the aspect ratio of the image.

The aspect ratio is switched within the screen range selected in the [DISPLAY OPTION] menu → [SCREEN SETTING] → [SCREEN FORMAT]. Set [SCREEN FORMAT] first. (➔ page 70)

1) Press ▲▼ to select [ASPECT].

2) Press ◀▶ or the <ENTER> button.

- The [ASPECT] individual adjustment screen is displayed.

3) Press ◀▶ to switch the item.

- The items will switch each time you press the button.

[AUTO]*1	The aspect ratio is automatically switched to the optimum aspect ratio when an aspect ratio identifier is included in the input signal.
[NORMAL]	Displays images without changing the aspect ratio of the input signals.
[WIDE]	Displays images with the aspect ratio converted to 16:9 when standard signals*2 are input. Display images without changing the aspect ratio when wide-screen signals*3 are input.
[H FIT]	Displays images using the entire width of the screen. When signals have the aspect ratio vertically longer than the aspect ratio of the screen selected in [SCREEN FORMAT]*4, the images are displayed with the top and bottom parts cut off.
[V FIT]	Displays the height of the panel pixels vertically without changing the aspect ratio when wide-screen signals are input. When signals have the aspect ratio horizontally longer than the aspect ratio of the screen, the images are displayed with the right and left parts cut off.
[FULL]	The image is projected using all the panel (screen) pixels. The input signals are converted to the aspect ratio of the panel (screen).
[NATIVE]	Displays images without changing the resolution of the input signals.

*1 Only for Video (NTSC) and 480i (Y_CC_R) signals input

*2 Standard signals are input signals with an aspect ratio of 4:3 or 5:4.

*3 Wide-screen signals are input signals with an aspect ratio of 16:10, 16:9 or 15:9.

Note

- The image size may be switched abnormally when [AUTO] is selected, please set to [NORMAL] or [WIDE] according to the input signal.
- Some size modes are not available for certain types of input signals.
- If an aspect ratio which is different from the aspect ratio for the input signals is selected, the images will appear differently from the originals. Be careful of this when selecting the aspect ratio.
- If using the projector in places such as cafes or hotels to display programs for a commercial purpose or for public presentation, note that adjusting the aspect ratio or using the zoom function to change the screen images may be an infringement of the rights of the original copyright owner for that program under copyright protection laws. Take care when using a function of the projector such as the aspect ratio adjustment and zoom function.
- If conventional (normal) 4:3 images which are not wide-screen images are displayed on a wide screen, the edges of the images may not be visible or they may become distorted. Such images should be viewed as with an aspect ratio of 4:3 in the original format intended by the creator of the images.

[FRAME LOCK]

(Only for still image RGB signals input)

This setting is available for specific computer signals. Set when the movie is distorted.

- 1) Press ▲▼ to select [FRAME LOCK].
- 2) Press ◀▶ or the <ENTER> button.
 - The [FRAME LOCK] individual adjustment screen is displayed.
- 3) Press ◀▶ to switch the [FRAME LOCK].
 - The items will switch each time you press the button.

[ON]	The frame is locked. Synchronizes the displayed image to the vertical scanning frequency of the input signal.
[OFF]	The frame lock function is turned off. Set to [OFF] if you are concerned about flickering.

[LANGUAGE] menu

On the menu screen, select [LANGUAGE] from the main menu, and select an item from the sub-menu. Refer to “Navigating through the menu” (➔ page 52) for the operation of the menu screen.

Changing the display language

You can select the language of the on-screen display.

1) Press ▲▼ to select the display language, and press the <ENTER> button.



- Various menus, settings, adjustment screens, control button names, etc., are displayed in the selected language.
- The language can be changed to English, German, French, Italian, Spanish, Portuguese, Dutch, Swedish, Finnish, Norwegian, Danish, Polish, Hungarian, Romanian, Czech, Russian, Turkish, Arabic, Kazakh, Vietnamese, Chinese, Korean, Japanese and Thai.

Note

- The on-screen display language is set to English in the factory default setting as well as when the [PROJECTOR SETUP] menu → [INITIALIZE ALL] is executed.

[DISPLAY OPTION] menu

On the menu screen, select [DISPLAY OPTION] from the main menu, and select an item from the sub-menu.

Refer to “Navigating through the menu” (⇒ page 52) for the operation of the menu screen.

[ON-SCREEN DISPLAY]

Set the on-screen display.

[INPUT GUIDE]

Set the input guide to be displayed when switching the input. The input guide screen shows the currently selected input and input signal names.

- 1) Press ▲▼ to select [ON-SCREEN DISPLAY].
- 2) Press the <ENTER> button.
 - The [ON-SCREEN DISPLAY] screen is displayed.
- 3) Press ▲▼ to select [INPUT GUIDE].
- 4) Press ◀▶ to switch the item.
 - The items will switch each time you press the button.

[DETAILED]	Displays the name of input terminal and input signal graphically.
[OFF]	Disables the input guide.
[SIMPLE]	Displays the name of input terminal and input signal.

[OSD POSITION]

Set the position of the menu screen (OSD).

- 1) Press ▲▼ to select [ON-SCREEN DISPLAY].
- 2) Press the <ENTER> button.
 - The [ON-SCREEN DISPLAY] screen is displayed.
- 3) Press ▲▼ to select [OSD POSITION].
- 4) Press ◀▶ to switch the item.
 - The items will switch each time you press the button as following:
[CENTER] → [UPPER LEFT] → [UPPER RIGHT] → [LOWER LEFT] → [LOWER RIGHT] → [CENTER] → ...

[WARNING MESSAGE]

Set the display/hide of the warning message.

- 1) Press ▲▼ to select [ON-SCREEN DISPLAY].
- 2) Press the <ENTER> button.
 - The [ON-SCREEN DISPLAY] screen is displayed.
- 3) Press ▲▼ to select [WARNING MESSAGE].
- 4) Press ◀▶ to switch the item.
 - The items will switch each time you press the button.

[ON]	Displays the warning message.
[OFF]	Hides the warning message.

Note

- When [WARNING MESSAGE] is set to [OFF], the warning message will not be displayed on the projected image even if a warning status such as “TEMPERATURE WARNING” is detected. The prompting message for filter replacement or lamp unit replacement will not be displayed either.

[HDMI SIGNAL LEVEL]

Switch the setting when the external equipment is connected to the <HDMI 1 IN> / <HDMI 2 IN> terminal of the projector and the image is not projected correctly.

- 1) Press ▲▼ to select [HDMI SIGNAL LEVEL].
- 2) Press ◀▶ to switch the item.
 - The items will switch each time you press the button.

[AUTO]	Sets the signal level automatically.
[64-940]	Select when the HDMI terminal of an external device (such as a blu-ray player) is connected to the <HDMI 1 IN> / <HDMI 2 IN> terminal.
[0-1023]	Select when the DVI terminal output of an external device (such as a computer) is connected to the <HDMI 1 IN> / <HDMI 2 IN> terminal via a conversion cable or similar cable. Select also when the HDMI terminal output of a computer or other device is connected to the <HDMI 1 IN> / <HDMI 2 IN> terminal.

Note

- The same setting of the [SIGNAL LEVEL] is set to the <HDMI 1 IN> terminal and <HDMI 2 IN> terminal.
- The optimal setting varies depending on the output setting of the connected external device. Refer to the operation instruction of the external device regarding the output of the external device.
- The displayed signal level is assumed when the input is 30 bits.

[CLOSED CAPTION SETTING] (Only for NTSC, 480i YC_BC_R input)

Set the closed caption.

Selecting the closed caption display

- 1) Press ▲▼ to select [CLOSED CAPTION SETTING].
- 2) Press the <ENTER> button.
 - The [CLOSED CAPTION SETTING] screen is displayed.
- 3) Press ▲▼ to select [CLOSED CAPTION].
- 4) Press ◀▶ to switch the item.
 - The items will switch each time you press the button.

[OFF]	Closed captions are not displayed.
[ON]	Closed captions are displayed.

- When [ON] is selected, proceed to Step 5).

- 5) When the confirmation is displayed, select [OK], and press the <ENTER> button.

Setting the closed caption mode

- 1) Press ▲▼ to select [CLOSED CAPTION SETTING].
- 2) Press the <ENTER> button.
 - The [CLOSED CAPTION SETTING] screen is displayed.
- 3) Press ▲▼ to select [MODE].
- 4) Press ◀▶ to switch the item.
 - The items will switch each time you press the button.

[CC1]	Displays CC1 data.
[CC2]	Displays CC2 data.
[CC3]	Displays CC3 data.
[CC4]	Displays CC4 data.

Note

- Closed caption is a function that displays text information of video signals mainly used in North America. Captions may not be displayed depending on the connected devices or contents being played back.
- [CLOSED CAPTION SETTING] can only be selected if an NTSC or 480i YC_BC_R signal is input.
- If [CLOSED CAPTION SETTING] is set to [ON], the brightness of image may be changed according to the external devices or the used content of the closed caption corresponding connection.
- If a closed caption signal of the selected mode is input, the text is not displayed even when the [SECURITY] menu → [TEXT DISPLAY] (▶ page 82) is set to [ON].
- Closed captions are not displayed when the menu screen is displayed.

[SCREEN SETTING]

Set the screen size.

When changing the aspect ratio of a projected image, correct to the optimum image position for the set screen. Set as necessary for the screen in use.

- 1) Press ▲▼ to select [SCREEN SETTING].
- 2) Press the <ENTER> button.
 - The [SCREEN SETTING] screen is displayed.
- 3) Press ▲▼ to select [SCREEN FORMAT].
- 4) Press ◀▶ to switch the [SCREEN FORMAT] item.
 - The items will switch each time you press the button.

Model No.	[SCREEN FORMAT]	The available items to set when [SCREEN POSITION] is selected
PT-VW360	[16:10]	Cannot be set.
	[16:9]	Three items of [CENTER], [HIGH] and [LOW] can be selected for vertical position.
	[4:3]	Three items of [CENTER], [LEFT] and [RIGHT] can be selected for horizontal position.
PT-VX430	[4:3]	Cannot be set.
	[16:9]	Three items of [CENTER], [HIGH] and [LOW] can be selected for vertical position.
	[16:10]	

- 5) Press ▲▼ to select [SCREEN POSITION].
 - In the following cases, the [SCREEN POSITION] cannot be set.
 - For PT-VW360, if [SCREEN FORMAT] is set to [16:10].
 - For PT-VX430, if [SCREEN FORMAT] is set to [4:3].
- 6) Press ◀▶ to adjust the [SCREEN POSITION].
 - The items will switch each time you press the button.

[STARTUP LOGO]

Set the logo display when the power is turned on.

- 1) Press ▲▼ to select [STARTUP LOGO].
- 2) Press ◀▶ to switch the item.
 - The items will switch each time you press the button.

[DEFAULT LOGO]	Displays the Panasonic logo.
[USER LOGO]	Displays the image registered by the user.
[OFF]	Disables the startup logo display.

Note

- The startup logo will disappear in approximately 30 seconds.
- To create/register the [USER LOGO] image, use "Logo Transfer Software". The software can be downloaded from the Panasonic website (<https://panasonic.net/cns/projector/>).

[AUTO SETUP SETTING]

Set the automatic execution of AUTO SETUP.

The screen display position or signal level can be adjusted automatically without pressing the <AUTO SETUP> button on the remote control on each occasion if you input unregistered signals frequently at meetings, etc.

1) Press ▲▼ to select [AUTO SETUP SETTING].

2) Press ◀▶ to switch the item.

- The items will switch each time you press the button.

[AUTO]	If the image being projected changes to an unregistered signal, the auto setup is automatically performed.
[BUTTON]	Enables the auto setup function only when the <AUTO SETUP> button is pressed.

[SIGNAL SEARCH]

Set to enable/disable the signal search function.

If the signal search function is enabled, the input with input signal is automatically selected when the power is turned on and the projection is started. In addition, if the <AUTO SETUP> button is pressed when the currently selected input has no signal, it automatically switches to the input with input signal.

1) Press ▲▼ to select [SIGNAL SEARCH].

2) Press ◀▶ to switch the item.

- The items will switch each time you press the button.

[ON]	Enables the input detection function.
[OFF]	Disables the input detection function.

[BACK COLOR]

Set the display of the projected screen when there is no signal input.

1) Press ▲▼ to select [BACK COLOR].

2) Press ◀▶ to switch the item.

- The items will switch each time you press the button.

[BLUE]	Displays the entire projection area in blue.
[BLACK]	Displays the entire projection area in black.
[DEFAULT LOGO]	Displays the Panasonic logo.
[USER LOGO]	Displays the image registered by the user.

Note

- To create/register the [USER LOGO] image, use "Logo Transfer Software". The software can be downloaded from the Panasonic website (<https://panasonic.net/cns/projector/>).
- If you do not register the image of the [USER LOGO], the projected image will be displayed in black even if the [BACK COLOR] is set to [USER LOGO].

[WIDE MODE]

Use this function when the image is displayed incorrectly for the input signals.

1) Press ▲▼ to select [WIDE MODE].

2) Press ◀▶ to switch the item.

- The items will switch each time you press the button.

[AUTO]	Displays by judging the signal automatically. Set to this mode normally.
[OFF]	When input the 4:3 signal.
[ON]	When input the wide signal.

[SXGA MODE]

This function is used if the whole projected image is not displayed when the resolution 1 280 x 1 024 dots of the SXGA signal is input.

- 1) Press ▲▼ to select [SXGA MODE].
- 2) Press ◀▶ to switch the item.
 - The items will switch each time you press the button.

[AUTO]	Displays by judging the signal automatically. Set to this mode normally.
[1280x1024]	Switches the item to [1280x1024] or [1400x1050] manually if the whole projected image is not displayed when SXGA signal is input.
[1400x1050]	

[P-TIMER]

Set and operate the presentation timer function.

- 1) Press ▲▼ to select [P-TIMER].
- 2) Press the <ENTER> button.
 - The [P-TIMER] screen is displayed.

[MODE]	Switches the elapsed time between [COUNT UP] and [COUNT DOWN].
[TIMER]	Sets the finish time of timer when [COUNT DOWN] is selected.
[START] / [STOP] / [RESTART]	Operates the timer.
[RESET]	Resets the count.
[EXIT]	The presentation timer function is ended.

Setting [MODE]

- 1) Press ▲▼ to select [MODE].
- 2) Press ◀▶ to switch the item.
 - The items will switch each time you press the button.

[COUNT UP]	Displays the elapsed time since the count was started.
[COUNT DOWN]	Displays the remaining time of the time set by [TIMER].

Setting the countdown timer

- 1) Press ▲▼ to select [TIMER].
- 2) Press ◀▶ to set the timer.
 - The time can be set in 1-minute increments from 1 to 180 minutes.
 - The factory default value is 10 minutes.

Note

- [TIMER] is available only when [MODE] is set to [COUNT DOWN].

The operation of [P-TIMER]

- 1) Press ▲▼ to select one item.

[START]	The count is started.
[STOP]	The count is stopped.
[RESTART]	The count is resumed.
[RESET]	The count is reset.

- 2) Press the <ENTER> button.

- When you select [START] or [RESTART], the remaining time or the elapsed time will be displayed in the lower right of the projected image.
- When you select [STOP], the remaining time or the elapsed time while stopping the counting will be displayed in the lower right of the projected image.

Note

- You can also use the P-TIMER function by pressing the <P-TIMER> button on the remote control (► page 48).
- If the elapsed time or remaining time is displaying, the text will not be displayed even when the [SECURITY] menu → [TEXT DISPLAY] (► page 82) is set to [ON].
- The elapsed time or remaining time will not be displayed when the menu screen is displaying.

- The start time will be "000:00" when [MODE] is set to [COUNT UP].
- When [MODE] is set to [COUNT DOWN], the start time becomes the value set at [TIMER].
- The time gauge turns clockwise when [COUNT UP] is set, and turns counterclockwise when [COUNT DOWN] is set.

Ending the presentation timer

- 1) Press ▲▼ to select [P-TIMER].
- 2) Press the <ENTER> button.
 - The [P-TIMER] screen is displayed.
- 3) Press ▲▼ to select [EXIT].
- 4) Press the <ENTER> button.

[OTHER FUNCTIONS]

The same function can be realized by operating the menu as an alternative of operating the remote control button.

- 1) Press ▲▼ to select [OTHER FUNCTIONS].
- 2) Press the <ENTER> button.
 - The [OTHER FUNCTIONS] screen is displayed.
- 3) Press ▲▼ to select one item.

[AUTO SETUP]	Automatically adjust the resolution, the clock phase and the image position when analog RGB signals consisting of bitmap images such as computer signals are being input. For details, refer to "Using the auto setup function". (➡ page 47)
[FREEZE]	The projected image is paused temporarily and the sound stopped regardless of the playback of the external equipment. Also press the <RETURN> button or the <FREEZE> button on the remote control to release this function.
[AV MUTE]	Turn off audio and image when the projector is not used for a certain period of time. You can also deactivate the function by pressing the <RETURN> button or the <AV MUTE> button on the remote control.
[DIGITAL ZOOM]	Enlarge images and move the image zoom position. For details, refer to "Using the digital zoom function via the menu operation". (➡ page 73)

- 4) Press the <ENTER> button.

Using the digital zoom function via the menu operation

(Only for the still image signals)

- 1) Press ▲▼ to select [DIGITAL ZOOM].
- 2) Press the <ENTER> button.
 - The [DIGITAL ZOOM] individual adjustment screen is displayed.
- 3) Press ◀▶ to adjust the magnification.

Operation menu	Operation	Adjustment	Adjustment range
	Press the ▶ button.	Increases magnification.	1.0 ~ 3.0
	Press the ◀ button.	Decreases magnification.	

- 4) Press the <ENTER> button.
 - The moving screen is displayed.
- 5) Press ▲▼◀▶ to move the zoom position.
 - For details, refer to "Using the digital zoom function". (➡ page 48)

Note

- Magnification can be set from 1.0x to 3.0x in 0.1 increments.
- The digital zoom function is canceled if the input signal changes during a digital zoom.
- During a digital zoom, the freeze function is disabled.
- The digital zoom function may not work properly for some still image-based signals.

[PROJECTOR SETUP] menu

On the menu screen, select [PROJECTOR SETUP] from the main menu, and select an item from the sub-menu.

Refer to “Navigating through the menu” (➔ page 52) for the operation of the menu screen.

[STATUS]

You can check the using status of the projector.

- 1) Press ▲▼ to select [STATUS].
- 2) Press the <ENTER> button.
 - The [STATUS] screen is displayed.

[SIGNAL]	[NAME]	Displays the name of input signal.		
	[FREQUENCY]	Displays the scanning frequency of input signal.		
[RUNTIME]	[PROJECTOR]	Displays the actual usage time of projector.		
	[LAMP (ET-LAV300)]		Displays the model No. of the replacement lamp unit for this projector.	
		[ECO]	Displays the luminous lamp runtime in actual time when [LAMP POWER] is set to [ECO].	
		[NORMAL]	Displays the luminous lamp runtime in actual time when [LAMP POWER] is set to [NORMAL].	
[TOTAL] ^{*1}	Displays the total runtime converted from the runtime at [ECO] and [NORMAL]. Please use it to predict when to replace the lamp unit.			
[SERIAL NUMBER]	[PROJECTOR]	Displays the serial number of the projector.		

*1 The total runtime displayed is calculated automatically using the following conversion formula.

Formula for lamp unit replacement time (rough estimate)
$A \times 1 + B \times 5/7$
<ul style="list-style-type: none"> • A : The luminous lamp runtime when [LAMP POWER] is set to [NORMAL] • B : The luminous lamp runtime when [LAMP POWER] is set to [ECO]

Note

- If you attach a lamp unit used in a projector of a model different from the projector (PT-VW360, PT-VX430) to the projector, or when the lamp unit used in the projector to a projector of a different model, the [RUNTIME] displayed in [STATUS] may differ from the actual time.
- For the network status, refer to the [NETWORK/USB] menu → [STATUS]. (➔ page 88)
- The model number of the optional replacement lamp unit is subject to change without prior notice.

[COMPUTER1 INPUT SETTING]

Switch the input setting of the <COMPUTER 1 IN> terminal.

- 1) Press ▲▼ to select [COMPUTER1 INPUT SETTING].
- 2) Press ◀▶ to switch the item.
 - The items will switch each time you press the button.

[RGB/YP _B P _R]	Select when inputting the RGB signals or YP _B P _R (YC _B C _R) signals to the <COMPUTER 1 IN> terminal.
[Y/C]	Select when inputting the Y/C signals to the <COMPUTER 1 IN> terminal by using the D-SUB - S Video conversion cable (model number: ET-ADSV).

[COMPUTER2 SELECT]

Switch the input/output of the <COMPUTER 2 IN/1 OUT> terminal.

- 1) Press ▲▼ to select [COMPUTER2 SELECT].
- 2) Press ◀▶ to switch the item.
 - The items will switch each time you press the button.

[COMPUTER2 IN]	Select when inputting the RGB signals or YP _B P _R (YC _B C _R) signals to the <COMPUTER 2 IN/1 OUT> terminal.
[COMPUTER1 OUT]	Select when the RGB signals or YP _B P _R (YC _B C _R) signals input to the <COMPUTER 1 IN> terminal is output from the <COMPUTER 2 IN / 1 OUT> terminal.

Note

- When COMPUTER2 input is selected, [COMPUTER2 SELECT] cannot be set.

[PROJECTOR ID]

The projector has an ID number setting function that can be used when multiple projectors are used side by side to enable simultaneous control or individual control via a single remote control.

- 1) Press ▲▼ to select [PROJECTOR ID].
- 2) Press the <ENTER> button.
 - The [PROJECTOR ID] screen is displayed.
- 3) Press ▲▼ to select a projector ID.
 - Select one from [ALL], and [1] to [6].

[ALL]	Select when controlling projectors without specifying an ID number.
[1] - [6]	Select when specifying an ID number to control individual projector.

- 4) Press the <ENTER> button to set it.
 - [PROJECTOR ID] is set.

Note

- To specify an ID number for individual control, the ID number of a remote control must match the ID number of the projector.
- When the ID number is set to [ALL], the projector will operate regardless of the ID number specified during remote control or computer control.
If multiple projectors are set up side by side with ID set to [ALL], they cannot be controlled separately from the projectors with other ID numbers.
- Refer to "Setting the ID number of the remote control" (➔ page 49) for how to set the ID number on the remote control.

[INITIAL START UP]

Set the startup method when the projector is switched on after connecting the power plug to outlet.

- 1) Press ▲▼ to select [INITIAL START UP].
- 2) Press ◀▶ to switch the item.
 - The items will switch each time you press the button.

[LAST MEMORY]	Starts up in the status that before removing the power plug from the outlet or turning off the circuit breaker.
[STANDBY]	Starts up in the standby mode.
[ON]	Starts the projection immediately.

[PROJECTION METHOD]

Set the projection method in accordance with the installation status of the projector.
Change the projection method if the screen display is upside down or inverted.

- 1) Press ▲▼ to select [PROJECTION METHOD].
- 2) Press ◀▶ to switch the projection method.
 - The items will switch each time you press the button.

[AUTO]	Detects the projector's posture with built-in angle sensor, then switches to [FRONT/DESK] or [FRONT/CEILING]. Usually it is set to [AUTO] when projecting in front of the screen.
[FRONT/DESK]	Select when installing the projector on the desk, etc., in front of the screen.
[FRONT/CEILING]	Select when installing the projector in front of the screen with the Ceiling Mount Bracket (optional).
[REAR/DESK]	Select when installing the projector on the desk, etc. behind the screen (with a translucent screen).
[REAR/CEILING]	Select when installing the projector behind the screen (with a translucent screen) with the Ceiling Mount Bracket (optional).

Note

- When set to [AUTO], front projection or rear projection cannot be detected. When projecting from rear, please set the [PROJECTION METHOD] to [REAR/DESK] or [REAR/CEILING].
- Refer to "Angle sensor" (➔ page 30) for details on the range of the installation attitude that can be detected by the built-in angle sensor.

[HIGH ALTITUDE MODE]

Change the setting according to the altitude in which you use the projector.

- 1) Press ▲▼ to select [HIGH ALTITUDE MODE].
- 2) Press ◀▶ to switch the item.
 - The items will switch each time you press the button.

[OFF]	Select when using the projector in the elevation of below 1 400 m (4 593').
[HIGH1]	Select when using the projector in the elevation of above 1 400 m (4 593') and below 2 000 m (6 562').
[HIGH2]	Select when using the projector in the elevation of above 2 000 m (6 562') and below 2 700 m (8 858').

Note

- It is set to [OFF] when using the projector in the elevation of below 1 400 m (4 593'). It is set to [HIGH1] when using the projector in the elevation of above 1 400 m (4 593') and below 2 000 m (6 562'). It is set to [HIGH2] when using the projector in the elevation of above 2 000 m (6 562') and below 2 700 m (8 858'). Failure to do so may shorten the life of the internal parts and result in malfunctions.
- Do not set the projector in the elevation of 2 700 m (8 858') or above, otherwise it may shorten the life of the internal parts and result in malfunctions.
- When it is set to [HIGH1] or [HIGH2], the fan noise becomes louder and fan speed increases.

[LAMP POWER]

Switch the luminance of the luminous lamp according to the operating environment of the projector or the purpose.

- 1) Press ▲▼ to select [LAMP POWER].
- 2) Press ◀▶ to switch the item.
 - The items will switch each time you press the button.

[NORMAL]	Select when high luminance is required.
[ECO]	Select when high luminance is not required.

Note

- The projector can consume less power, extend the luminous lamp life longer and produce less operation noise when set from [NORMAL] to [ECO].

[ECO MANAGEMENT]

This function optimizes the luminous lamp power according to the operating status and reduces power consumption.

- 1) Press ▲▼ to select [ECO MANAGEMENT].
- 2) Press the <ENTER> button.
 - The [ECO MANAGEMENT] screen is displayed.
- 3) Press ▲▼ to select one item.

Setting [AUTO POWER SAVE] in Step 3)

Set whether or not to enable the three functions, [AMBIENT LIGHT DETECTION], [SIGNAL DETECTION] and [AV MUTE DETECTION].

Note

- [AUTO POWER SAVE] cannot be set when the [LAMP POWER] is set to [ECO].

- 4) Press ◀▶ to switch the [AUTO POWER SAVE].

[ON]	Enables power-saving mode.
[OFF]	Disables power-saving mode.

- 5) Press ▲▼ to select one item.

[AMBIENT LIGHT DETECTION]	Adjusts the luminous lamp power according to the ambient brightness.
[SIGNAL DETECTION]	Drops the luminous lamp power when no signal is input.
[AV MUTE DETECTION]	Drops the luminous lamp power in the AV mute mode.

- 6) Press ◀▶ to switch the item.

- The items will switch each time you press the button.

[ON]	Enables above setting.
[OFF]	Disables above setting.

Note

- Luminous lamp power cannot be reduced automatically in the following cases:
 - When the luminous lamp lighting is just completed or the setting of [LAMP POWER] is just completed, etc..
- When [AUTO POWER SAVE] is set to [OFF], settings of [AMBIENT LIGHT DETECTION], [SIGNAL DETECTION] and [AV MUTE DETECTION] are unavailable.
- When [LAMP POWER] is set to [ECO], settings of [AMBIENT LIGHT DETECTION], [SIGNAL DETECTION] and [AV MUTE DETECTION] are unavailable.
- When objects, etc. are placed on top of the projector, the luminance sensor may be blocked, therefore the brightness cannot be detected correctly. The projector may not work properly even [AMBIENT LIGHT DETECTION] is set to [ON].

Setting [POWER MANAGEMENT] in Step 3)

Set the operation as following if there is no signal input.

1) Press ▲▼ to select [POWER MANAGEMENT].

2) Press ◀▶ to switch the item.

- The items will switch each time you press the button.

[SHUT DOWN]	The countdown timer is displayed after 30 seconds without input signal. The luminous lamp turns off and cools down when the time set in [TIMER] has elapsed, then the projector enters into standby status.
[OFF]	Power management function is off.
[READY]	The countdown timer is displayed after 30 seconds without input signal. The luminous lamp will turn off and enter into standby status after cooling down when the time set in [TIMER] has elapsed. The luminous lamp will be turned on and enter into projection state if any signal is input or any button is pressed during standby mode.

Setting [TIMER]

You can set the time until the luminous lamp turns off with the power management function from 5 minutes to 120 minutes in increments of 5 minutes.

1) Press ▲▼ to select [TIMER].

2) Press ◀▶ to set the timer.

- The time will switch each time you press the button.

Setting [STANDBY MODE] in Step 3)

Set the operation mode during standby.

1) Press ▲▼ to select [STANDBY MODE].

2) Press ◀▶ to switch the item.

- The items will switch each time you press the button.

[NORMAL]	Select this item to use the network function or the serial communication function during standby.
[NETWORK]	Select this item to reduce power consumption during standby, and to operate the projector via the wired LAN or the serial communication function by using the Wake on LAN function.
[ECO]	Select this item to reduce power consumption during standby.

Note

- If [STANDBY MODE] is set to [ECO], you cannot use network functions when the projector is standing by. Also, you cannot use some RS-232C protocol commands.
- When set to [ECO] or [NETWORK], it may take approx. 10 seconds longer before the projector starts projecting after the power is turned on, compared with when [NORMAL] is set.
- If [STANDBY MODE] is set to [ECO] or [NETWORK], it takes less power consumption than it is set to [NORMAL].
- If [STANDBY MODE] is set to [NETWORK], then even in the standby status, serial communication becomes available within about 75 seconds after 15 seconds have elapsed upon receipt of the Wake on LAN command. In addition, network control becomes available within about 60 seconds after 30 seconds have elapsed upon receipt of the Wake on LAN command. When a network control command is received during the period in which network control is available, network control can be continued within about 60 seconds after receipt of the last command.
- The setting of [STANDBY MODE] cannot be returned to the factory default even if the [PROJECTOR SETUP] menu → [INITIALIZE ALL] is executed (➡ page 81).

[EMULATE]

When controlling the projector on a computer via the <SERIAL IN> terminal, set use of control commands on a previously purchased Panasonic projector. This allows the control software for an existing Panasonic projector to be inherited and used.

- 1) Press ▲▼ to select [EMULATE].
- 2) Press the <ENTER> button.
 - The [EMULATE] screen is displayed.
- 3) Press ▲▼ to select one item.

[DEFAULT]	VW360 series, VX430 series, VZ585N series, VW545N series, VX615N series, VZ580 series, VW540 series, VX610 series, VZ575N series, VW535N series, VX605N series, VZ570 series, VW530 series, VX600 series, VX60, VX50, EZ590 series, EZ57, EW650 series, EW550 series, EX620 series, EX520 series, FZ570 series, FW530 series, FX500 series, VZ470 series, VW355N series, VX425N series, VW350 series, VX420 series, EZ580 series, EW640 series, EX610 series, EW540 series, EX510 series, VW345N series, VX415N series, VW340Z, VX410Z, VX42Z, VX406EA, VX46EA, EZ770 series, EW730 series, EX800 series, RZ475 series, RZ470 series, RW430 series, RZ370 series, RW330 series
[D3500]	D3500 series
[D4000]	D4000 series
[D/W5k SERIES]	D5700 series, DW5100 series, D5600 series, DW5000 series, D5500 series
[D/W/Z6k SERIES]	MZ670 series, DZ870 series, DW830 series, DX100 series, DZ780 series, DW750 series, DX820 series, DZ770 series, DW740 series, DX810 series, DZ680 series, DW640 series, DX610 series, DW730 series, DX800 series, DZ6710 series, DZ6700 series, DW6300 series, D6000 series, D5000 series, DZ570 series, DW530 series, DX500 series, RZ970 series, RW930 series, RX110 series, RZ770 series, RZ660 series, RW730 series, RW620 series, RZ670 series, RW630 series, RZ575 series, RZ570 series
[L730 SERIES]	L730 series, L720 series, L520 series
[L780 SERIES]	L780 series, L750 series
[L735 SERIES]	L735 series
[L785 SERIES]	L785 series
[F/W SERIES]	FW430 series, FX400 series, FW300 series, F300 series, F200 series, FW100 series, F100 series
[LZ370]	LZ370 series
[LB/W SERIES]	LB3 series, LB2 series, LB1 series, ST10 series, LB90 series, LW80NT series, LB80 series, LB78 series, LB75 series
[VX500 SERIES]	VW435N series, VW440 series, VW430 series, VX505N series, VX510 series, VX500 series, VW330 series, VX400NT series, VX400 series, VX41 series
[EZ570 SERIES]	EZ570 series, EW630 series, EW530 series, EX600 series, EX500 series
[VW431D]	VW431D series

- 4) Press the <ENTER> button.

[FUNCTION BUTTON]

The function assigned to the <FUNCTION> button of the remote control is displayed. You can also release the assigned setting.

Releasing assigned function to the <FUNCTION> button

- 1) Press ▲▼ to select [FUNCTION BUTTON].
- 2) Press the <ENTER> button.
 - The [FUNCTION BUTTON] screen is displayed.
- 3) Press the <ENTER> button.
- 4) When the confirmation message is displayed, select [OK] and press the <ENTER> button.

Note

- You can also cancel the assigned settings by displaying the on-screen menu, selecting the menu item to be canceled (main menu, sub-menu or details menu), and then pressing the <FUNCTION> button for at least 3 seconds.

[AUDIO SETTING]

You can perform more detailed setting for Audio.

Adjusting the volume

- 1) Press ▲▼ to select [AUDIO SETTING].
- 2) Press the <ENTER> button.
 - The [AUDIO SETTING] screen is displayed.
- 3) Press ▲▼ to select [VOLUME].
- 4) Press ◀▶ to adjust the level.

Operation	Adjustment	Range
Press the ▶ button.	Increases the volume.	0 ~ 63
Press the ◀ button.	Decreases the volume.	

Adjusting the balance

- 1) Press ▲▼ to select [AUDIO SETTING].
- 2) Press the <ENTER> button.
 - The [AUDIO SETTING] screen is displayed.
- 3) Press ▲▼ to select [BALANCE].
- 4) Press ◀▶ to adjust the level.

Operation	Adjustment	Range
Press the ▶ button.	Increase the volume of the right channel.	L16 ~ R16
Press the ◀ button.	Increase the volume of the left channel.	

Setting the mute status

- 1) Press ▲▼ to select [AUDIO SETTING].
- 2) Press the <ENTER> button.
 - The [AUDIO SETTING] screen is displayed.
- 3) Press ▲▼ to select [MUTE].
- 4) Press ◀▶ to switch the item.

[OFF]	Outputs the audio.
[ON]	Turns off the volume temporarily.

Setting the audio output during standby

- 1) Press ▲▼ to select [AUDIO SETTING].
- 2) Press the <ENTER> button.
 - The [AUDIO SETTING] screen is displayed.
- 3) Press ▲▼ to select [IN STANDBY MODE].
- 4) Press ◀▶ to switch the item.
 - The items will switch each time you press the button.

[OFF]	Disables audio output in the standby mode.
[ON]	Enables audio output in the standby mode. At this time, press the <VOL +> button / <VOL -> button on the remote control or ◀▶ buttons on the control panel to adjust the volume.

Note

- When [ECO MANAGEMENT] → [STANDBY MODE] is set to [ECO] or [NETWORK] (► page 77), even if [IN STANDBY MODE] is set to [ON], audio cannot be output during standby.
- When the power is switched off at the digital signal input with [IN STANDBY MODE] set to [ON], the audio may be interrupted in the process of the projector entering the standby mode.

Setting audio input selection

Choose the audio input terminal for each input signal.

- 1) Press ▲▼ to select [AUDIO SETTING].
- 2) Press the <ENTER> button.
 - The [AUDIO SETTING] screen is displayed.
- 3) Press ▲▼ to select one item of [AUDIO IN SELECT].

[COMPUTER1]	Set the audio output when COMPUTER1 input is selected.
[COMPUTER2]	Set the audio output when COMPUTER2 input is selected.
[VIDEO]	Set the audio output when VIDEO input is selected.
[HDMI1]	Set the audio output when HDMI1 input is selected.
[HDMI2]	Set the audio output when HDMI2 input is selected.
[NETWORK]	Set the audio output when NETWORK input is selected.
[MEMORY VIEWER LIGHT]	Set the audio output when MEMORY VIEWER input is selected.
[USB DISPLAY]	Set the audio output when USB DISPLAY input is selected.

- 4) Press ◀▶ to switch the item.
 - The sub items will switch each time you press the button.

[COMPUTER1]	Select one item among [AUDIO IN 1], [AUDIO IN 2] or [AUDIO IN 3].
[COMPUTER2]	Select one item among [AUDIO IN 1], [AUDIO IN 2] or [AUDIO IN 3].
[VIDEO]	Select one item among [AUDIO IN 1], [AUDIO IN 2] or [AUDIO IN 3].
[HDMI1]	Select one item among [HDMI1 AUDIO IN], [AUDIO IN 1], [AUDIO IN 2] or [AUDIO IN 3].
[HDMI2]	Select one item among [HDMI2 AUDIO IN], [AUDIO IN 1], [AUDIO IN 2] or [AUDIO IN 3].
[NETWORK]	Select one item among [NETWORK AUDIO IN], [AUDIO IN 1], [AUDIO IN 2] or [AUDIO IN 3].
[MEMORY VIEWER LIGHT]	Select one item among [AUDIO IN 1], [AUDIO IN 2] or [AUDIO IN 3].
[USB DISPLAY]	Select one item among [USB DISPLAY AUDIO IN], [AUDIO IN 1], [AUDIO IN 2] or [AUDIO IN 3].

[TEST PATTERN]

Displays the test pattern built-in to the projector.

Settings of position, size, and other factors will not be reflected in test patterns. Make sure to display the input signal before performing various adjustments.

- 1) Press ▲▼ to select [TEST PATTERN].
- 2) Press the <ENTER> button.
 - The test pattern with the operation guide of [PATTERN CHANGE] is displayed.
- 3) Press ◀▶ to switch the test pattern.
 - The test pattern will switch each time you press the button.
 - When you press the <MENU> button or <RETURN> button, it will exit the test pattern and return to the Sub-menu of [PROJECT SETUP].

All white	Select a test pattern so that it is easy to make various adjustments.
Color bar (Vertical)	
Color bar (Horizontal)	
White cross on the black background	
Black cross on the white background	
Cross hatch	

Note

- The initial setting is All white. The initial screen is Cross hatch if you have assigned it to the <FUNCTION> button.

[FILTER COUNTER]

This function is used to check the usage time of the air filter or set the replacement cycle of the air filter. Also, you can reset the air filter usage time.

- 1) Press ▲▼ to select [FILTER COUNTER].
- 2) Press the <ENTER> button.
 - The [FILTER COUNTER] screen is displayed.

[FILTER COUNTER]	Displays the usage time of the filter.
[TIMER]	Sets the replacement cycle of the air filter.
[FILTER COUNTER RESET]	Resets the air filter usage time.

Setting [TIMER]

If you want to regularly replace the air filter, set its cycle time. When the air filter usage time reaches the set time, a message of “FILTER COUNTER has reached the set time” prompting you to replace the air filter is displayed on the projection screen.

- 1) Press ▲▼ to select [FILTER COUNTER].
- 2) Press the <ENTER> button.
 - The [FILTER COUNTER] screen is displayed.
- 3) Press ▲▼ to select [TIMER].
- 4) Press ◀▶ to switch the item.
 - The items will switch each time you press the button.

[1000 H] ~ [7000 H]	Select to display the message. You can set the replacement cycle of the air filter in increments of 1000 hours..
[OFF]	Select not to display the message.

Setting [FILTER COUNTER RESET]

Resets the usage time of the air filter.

- 1) Press ▲▼ to select [FILTER COUNTER].
- 2) Press the <ENTER> button.
 - The [FILTER COUNTER] screen is displayed.
- 3) Press ▲▼ to select [FILTER COUNTER RESET].
- 4) Press the <ENTER> button.
- 5) When the confirmation screen is displayed, press ◀▶ to select [OK] and then press the <ENTER> button.
 - The display of [FILTER COUNTER] changes to “0H”.

[INITIALIZE ALL]

Return various setting values to their factory default settings.

- 1) Press ▲▼ to select [INITIALIZE ALL].
- 2) Press the <ENTER> button.
 - The [INITIALIZE ALL] screen is displayed.
- 3) When the confirmation is displayed, press ◀▶ to select [OK] and then press the <ENTER> button.
 - The [NOW INITIALIZING...] screen is displayed and then the [POWER OFF.] screen will be displayed.
- 4) Press the <ENTER> button.
 - The operation of other buttons is disabled.
 - The initial setting (display language) screen will be displayed when turning on the projector next time.

Note

- The projector will enter into the standby status to reflect the setting values when [INITIALIZE ALL] is executed.
- When [INITIALIZE ALL] is executed, [STANDBY MODE], [EMULATE], [FILTER COUNTER] and the setting values of [NETWORK/USB] cannot be returned to the factory default values. For details about the initialization of [NETWORK/USB], please refer to [NETWORK/USB] → [INITIALIZE] (➔ page 88).

[SECURITY] menu

On the menu screen, select [SECURITY] from the main menu, and select an item from the sub-menu. Refer to “Navigating through the menu” (⇒ page 52) for the operation of the menu screen.

- When the projector is used for the first time
Initial password: Press ▲▶▼◀◀▶▶▼◀ in order, and press the <ENTER> button.

Attention

- When you select the [SECURITY] menu and press the <ENTER> button, entering a password is required. Enter the preset password and then continue operations of the [SECURITY] menu.
- When the password has been changed previously, enter the changed password, and press the <ENTER> button.

Note

- The entered password is displayed with "*" mark on the screen.
- An error message is displayed on the screen when the entered password is incorrect. Re-enter the correct password.

[PASSWORD]

The [PASSWORD] screen is displayed when the power is turned on, [INITIALIZE ALL] is executed or [INITIALIZE] in the [NETWORK/USB] menu is executed. When the entered password is incorrect, the operation will be restricted to the power standby <⏻/|> button on the control panel or on the remote control.

- 1) Press ▲▼ to select [PASSWORD].
- 2) Press ◀▶ to switch the item.
 - The items will switch each time you press the button.

[OFF]	Disables the security password entry.
[ON]	Enables the security password entry.

Note

- The [PASSWORD] setting is set to [OFF] by the factory default.
- The security password input when turning on the power is not enabled until turning off the power supply and plugging the power plug into the outlet after setting it to [ON]. If the entered password is incorrect when the power is turned on, the operation will be restricted to the power <⏻/|> button.

[PASSWORD CHANGE]

Change the security password.

- 1) Press ▲▼ to select [PASSWORD CHANGE].
- 2) Press the <ENTER> button.
 - The [PASSWORD CHANGE] screen is displayed.
- 3) Press ▲▼◀▶ or number buttons (<1> - <6>) to set the password.
 - Up to eight button operations can be set.
- 4) Press the <ENTER> button.
- 5) Re-enter the password for the confirmation.
- 6) Press the <ENTER> button.

Note

- The entered password is displayed with "*" mark on the screen.
- Change the password periodically and make it hard to guess.
- An error message is displayed on the screen when the entered password is incorrect. Re-enter the correct password.
- If numbers have been used for the security password, the security password will need to be initialized again if the remote control is lost. Consult your dealer for the initialization method.

[TEXT DISPLAY]

Overlap the security message (text) over the projecting image.

- 1) Press ▲▼ to select [TEXT DISPLAY].

2) Press ◀▶ to switch the item.

- The items will switch each time you press the button.

[OFF]	Disables the text display.
[ON]	Enables the text display.

[TEXT CHANGE]

Register or change the displayed text when [TEXT DISPLAY] is set to [ON].

1) Press ▲▼ to select [TEXT CHANGE].

2) Press the <ENTER> button.

- The [TEXT CHANGE] screen is displayed.

3) Press ▲▼◀▶ to select the text, and press the <ENTER> button to enter the text.

4) Press ▲▼◀▶ to select [OK], and press the <ENTER> button.

- The text is changed.

[MENU LOCK]

Display the menu by the <MENU> button and set whether or not to enable menu operations.

1) Press ▲▼ to select [MENU LOCK].

2) Press ◀▶ to switch the item.

- The items will switch each time you press the button.

[OFF]	Enables menu operations.
[ON]	Disables menu operations.

Note

- When the entered password is incorrect after setting [MENU LOCK] to [ON], the <MENU> button cannot be operated.
- The factory default setting or the setting after executing the [PROJECTOR SETUP] menu → [INITIALIZE ALL] is set to [OFF]. Set it to [ON] if necessary.
- When [MENU LOCK] is set to [ON], the [MENU LOCK PASSWORD] screen is displayed after pressing the <MENU> button. After entering the set menu lock password, the menu operation is enabled. In this case, the menu operation will remain enabled until the projector enters into standby mode.

[MENU LOCK PASSWORD]

Change the menu lock password.

1) Press ▲▼ to select [MENU LOCK PASSWORD].

2) Press the <ENTER> button.

- The [MENU LOCK PASSWORD] screen is displayed.

3) Press ▲▼◀▶ to select the text, and press the <ENTER> button to enter the text.

- Up to 16 characters can be input.

4) Press ▲▼◀▶ to select [OK], and press the <ENTER> button.

- To cancel, select [CANCEL].

Attention

- The initial password is "AAAA" at the time of purchase or when the [PROJECTOR SETUP] menu → [INITIALIZE ALL] is executed.
- Change the password periodically that is hard to guess.

[CONTROL DEVICE SETUP]

Enable/disable the button operations on the control panel and the remote control.

1) Press ▲▼ to select [CONTROL DEVICE SETUP].

2) Press the <ENTER> button.

- The [CONTROL DEVICE SETUP] screen is displayed.

3) Press ▲▼ to select one item between [CONTROL PANEL] and [REMOTE CONTROLLER].

[CONTROL PANEL]	You can set the limitation on the control from the control panel.
[REMOTE CONTROLLER]	You can set the limitation on the control from the remote control.

4) Press ◀▶ to switch between [ENABLE] and [DISABLE].

- You can set the limitation on the control from the control panel or the remote control.

[ENABLE]	Enable the button operations.
[DISABLE]	Disable the button operations.

- A confirmation screen will be displayed when you change [ENABLE] to [DISABLE], then proceed to Step 5).

5) Press ◀▶ to select [OK], and then press the <ENTER> button.

Note

- When a button operation is performed on the device set to [DISABLE] , the [PASSWORD] screen is displayed. To continue operations, enter the security password.
- The [PASSWORD] screen will disappear when there is no operation for approx. 10 seconds.
- If the operations of both [CONTROL PANEL] and [REMOTE CONTROLLER] are set to [DISABLE], the projector cannot be turned off (cannot enter standby).
- Even when you set button operations on the remote control to be disabled, operations of the <ID ALL> and <ID SET> buttons on the remote control are enabled.

[NETWORK/USB] menu

On the menu screen, select [NETWORK/USB] from the main menu, and select an item from the sub-menu. Refer to “Navigating through the menu” (➔ page 52) for the operation of the menu screen.

Note

- The on-screen menu (menu screen) of the projector has not the network setting about the wireless LAN. When the wireless module (Model No.: ET-WML100) of the optional accessories is inserted to the projector, please set the wireless LAN by accessing the projector via a computer. For detailed, please refer to “Web control function” → “[Network config] page” → “Wireless LAN” (➔ page 105).

[WIRED LAN]

Perform the connection settings to use wired LAN.

- Press ▲▼ to select [WIRED LAN].
- Press the <ENTER> button.
 - The [WIRED DETAILED SETUP] screen is displayed.
- Press ▲▼ to select an item, and change the setting according to the instructions.

[DHCP]	[OFF]	Set when a DHCP server does not exist in the network to which the projector is connected and you need to specify the IP address.
	[ON]	Set when a DHCP server exists in the network to which the projector is connected and the IP address is obtained automatically.
[IP ADDRESS]	Enter the IP address when [DHCP] is set to [OFF].	
[SUBNET MASK]	Enter the subnet mask when [DHCP] is set to [OFF].	
[DEFAULT GATEWAY]	Enter the default gateway address when [DHCP] is set to [OFF].	
[DNS1]	Enter the preferred DNS server address when [DHCP] is set to [OFF].	
[DNS2]	Enter the alternate DNS server address when [DHCP] is set to [OFF].	

- Press ▲▼ to select [OK], and press the <ENTER> button.

■ Default wired LAN settings

- The following settings are set before the projector leaves the factory.

[DHCP]	OFF
[IP ADDRESS]	192.168.10.100
[SUBNET MASK]	255.255.255.0
[DEFAULT GATEWAY]	192.168.10.1
[DNS1]/[DNS2]	NONE

Note

- When using a DHCP server, confirm that the DHCP server is running.
- For the setting content of each item, consult your network administrator.
- A wired LAN and wireless LAN cannot be used in the same segment.

[NAME CHANGE]

Change the name as desired in such a case as the projector needs to be identified on application software.

- Press ▲▼ to select [NAME CHANGE].
- Press the <ENTER> button.
 - The [NAME CHANGE] screen is displayed.
- Select characters with the ▲▼◀▶ buttons and press the <ENTER> button to enter the projector name.
 - Up to eight characters can be input.
 - Select [ALL DELETE] to delete all the entered characters, or press the <DEFAULT> button on the remote control to delete a character on the cursor in the entry field.

4) Select [OK] with the ▲▼ buttons and press the <ENTER> button.

- To cancel the change of the name, select [CANCEL] and press the <ENTER> button.

Note

- [Name □□□□] (□□□□ is 4-digit number) is set before the projector leaves the factory.

[NETWORK CONTROL]

Set when you want to control the projector from a computer connected to the network.

1) Press ▲▼ to select [NETWORK CONTROL].

2) Press ◀▶ to switch the item.

- The items will switch each time you press the button.

[ON]	This function is enabled. Web control, PJLink control, and the command control of the LAN are enabled.
[OFF]	This function is disabled.

[AMX D.D.]

Set to [ON] to control with the controller of AMX Corporation.

Setting this function to [ON] enables detection through "AMX Device Discovery". For details, refer to the website of AMX Corporation.

URL <http://www.amx.com/>

1) Press ▲▼ to select [AMX D.D.].

2) Press ◀▶ to switch the item.

- The items will switch each time you press the button.

[OFF]	This function is disabled.
[ON]	This function is enabled.

[Crestron Connected(TM)]

Set to [ON] to control with Crestron Connected™ of Crestron Electronics, Inc.

1) Press ▲▼ to select [Crestron Connected(TM)].

2) Press ◀▶ to switch the item.

- The items will switch each time you press the button.

[OFF]	This function is disabled.
[ON]	This function is enabled.

[MEMORY VIEWER LIGHT]

Set the operations of the Memory Viewer Light function.

Note

- The [MEMORY VIEWER LIGHT] menu can be operated and set only when MEMORY VIEWER input is selected.
- For details on how to use the memory viewer function, please refer to "Memory Viewer function" (➔ page 90).

[SET SLIDE]

Start the slideshow. For details on the slideshow, see "Executing the slide" (➔ page 91).

[SLIDE TRANSITION EFFECT]

Sets the transition effects when switching the slides playback.

1) Press ▲▼ to select [SLIDE TRANSITION EFFECT].

2) Press ◀▶ to switch the item.

- The items will switch each time you press the button.

[SLIDE RIGHT]	The slides switch from left to right.
[SLIDE DOWN]	The slides switch from top to bottom.

- 3) Press ▲▼ to select [APPLY].
- 4) Press the <ENTER> button.
 - The setting will be effective.

[SORT ORDER]

Sets the order of images to be played in the slideshow.

- 1) Press ▲▼ to select [SORT ORDER].
- 2) Press ◀▶ to switch the item.
 - The items will switch each time you press the button.

[NAME ORDER]	Displays the files or folders in ascending order of their names.
[TIME ORDER]	Displays the files or folders in the order of their modification date and time.
[SIZE ORDER]	Displays the files or folders in descending order of their data size.
[EXTEND ORDER]	Displays the files or folders in ascending order of their extensions.

- 3) Press ▲▼ to select [APPLY].
- 4) Press the <ENTER> button.
 - The setting will be effective.

[ROTATE]

Sets the rotational direction of the images.

- 1) Press ▲▼ to select [ROTATE].
- 2) Press ◀▶ to switch the item.
 - The items will switch each time you press the button.

[NO ROTATE]	Rotation is disabled.
[90 DEGREE]	Rotate 90 degrees clockwise.
[180 DEGREE]	Rotate 180 degrees clockwise.
[270 DEGREE]	Rotate 270 degrees clockwise (90 degrees counterclockwise).

- 3) Press ▲▼ to select [APPLY].
- 4) Press the <ENTER> button.
 - The setting will be effective.

[BEST FIT]

Sets whether to fit the image to the projection screen.

- 1) Press ▲▼ to select [BEST FIT].
- 2) Press ◀▶ to switch the item.
 - The items will switch each time you press the button.

[OFF]	Displays the image in its original pixels.
[ON]	Displays the image according to the screen set in the [DISPLAY OPTION] menu → [SCREEN SETTING].

- 3) Press ▲▼ to select [APPLY].
- 4) Press the <ENTER> button.
 - The setting will be effective.

[REPEAT]

Sets whether to loop the slideshow.

- 1) Press ▲▼ to select [REPEAT].
- 2) Press ◀▶ to switch the item.
 - The items will switch each time you press the button.

[OFF]	After playing the last file, exit the slideshow and return to the thumbnail display.
[ON]	After playing the last file, return to the first file and repeat playback.

- 3) Press ▲▼ to select [APPLY].
- 4) Press the <ENTER> button.
 - The setting will be effective.

[STATUS]

Displays the current network status of the projector.

- 1) Press ▲▼ to select [STATUS].
- 2) Press the <ENTER> button.
 - The [STATUS] screen is displayed.
 - Press ▲▼ to switch the screens (1/2 [WIRED LAN] → 2/2 [WIRELESS LAN] / [Presenter Light]).

[WIRED LAN]	[DHCP]	Displays the usage state of the DHCP server.
	[IP ADDRESS]	Displays the IP address.
	[SUBNET MASK]	Displays the subnet mask.
	[DEFAULT GATEWAY]	Displays the default gateway.
	[DNS1]	Displays the address of the primary DNS server.
	[DNS2]	Displays the address of the secondary DNS server.
	[MAC ADDRESS]	Displays the MAC address of wired LAN.
[WIRELESS LAN]	[SSID]* ¹	Displays the character string of SSID.
	[IP ADDRESS]* ¹	Displays the IP address.
[Presenter Light]	[LOGIN PASSWORD]	Displays the login password of Presenter Light.

*1 The [SSID] / [IP address] of [Wireless LAN] are displayed when the optional wireless module (Model No.: ET-WML100) is attached.

Note

- There is no network setting for the wireless LAN in the projector menu (menu screen). When you attach the optional wireless module (Model No.: ET-WML100), you can access the projector via the computer for wireless LAN setting. For details, see "Web control function" → [Network config] page → "Wireless LAN" (➔ page 105).

[INITIALIZE]

This function is used to return various setting values of [NETWORK/USB] to the factory default value.

- 1) Press ▲▼ to select [INITIALIZE].
- 2) Press the <ENTER> button.
 - The [INITIALIZE] screen is displayed.
- 3) Press ◀▶ to select [OK] and then press the <ENTER> button.

Note

- If the [SECURITY] menu → [PASSWORD] is set to [ON], the [PASSWORD] screen will be displayed when [INITIALIZE] is selected and the <ENTER> button is pressed. Continue your operation after entering the security password set for the projector.

Chapter 5 **Operation of Function**

This chapter describes the operation methods of some functions.

Memory Viewer function

The Memory Viewer function makes it possible to display the still images stored in the USB memory as projected images.

Images that can be played back with the Memory Viewer function

The Memory Viewer function of this projector supports the following files.

	Extension	Format	Description
Picture	jpg/jpeg	Baseline coding 24 bits Progressive RGB 24 bits	Resolution : 8 x 8 ~ 10 000 x 10 000 Resolution : 8 x 8 ~ 1 280 x 800
	bmp	Palette-based 1, 4, 8 bits, RGB 24, 32 bits	The maximum resolution : 1 280 x 800
	png	True color 24 bits/48 bits	The maximum resolution : 1 280 x 800
	gif	Palette-based 1, 4, 8 bits,	Palette - 24 bits color spaces; The maximum resolution : 1 280 x 800
	tif / tiff	—	The maximum resolution : 1 280 x 800

Note

- File size that can be played back is 2 GB at the maximum.
- The total number of folders/files that can be recognized on the projector is 500 at the maximum. In addition, the folders/files in the format other than those listed above cannot be displayed.
- Files protected by DRM (Digital Rights Management) cannot be played back.
- It may be impossible to play even if the file is recorded in the supported format.

Cautions on using USB Memory

Please observe the following.

- Do not put USB memory or its cap within close reach of children. Swallowing them may cause suffocation.
- If the smoke or questionable odor rise, remove the USB memory from the projector, and then contact your dealer.
- Do not put water, chemical or oil to the USB memory. It may cause short out or fire.
- Do not put foreign objects or put metal objects to the USB terminal. It may cause data loss or data corruption.
- Do not remove the USB memory from the computer or the projector while the USB memory is reading out the data. It may cause data loss or data corruption.
- Do not store the USB memory where high temperature, humid or dusty place or magnetized items are around.

Note

- It is compatible with the USB memory sold in the market.
- It cannot be used the other format other than the formatted with FAT16 and FAT32.

Attaching the USB memory

- 1) Attach the USB memory firmly into the <USB A (VIEWER/WIRELESS)> terminal.

Attention

- Pay attention to the terminal direction to avoid damaging the terminal when attaching the USB memory.
- Attach the USB memory directly into the <USB A (VIEWER/WIRELESS)> terminal of the projector. Do not use a USB extension cable or USB hub.

Removing the USB memory

- 1) Make sure that the indicator on the USB memory is not blinking, and remove it.

Attention

- Please note following points when removing the USB memory.
 - When the indicator of the USB memory attached to the projector is blinking, it indicates that the projector is reading the USB memory. Do not remove the USB memory from the projector while the indicator is blinking.
 - When using a USB memory that does not have a monitor function such as an indicator, you cannot check the access status to the USB memory. In this case, remove it from the projector after closing the memory viewer function or turning off the projector.
 - Do not attach and detach the USB memory in a short time. Wait at least 5 seconds after attaching and then remove the USB memory. If you want to reattach it, wait at least 5 seconds after removal. It takes about 5 seconds for the projector to recognize the USB memory.

Displaying the Memory Viewer screen

- 1) Press the <MEMORY VIEWER/USB DISPLAY/NETWORK> button on the remote control or switch the input source to MEMORY VIEWER.
 - Press the <INPUT SELECT> button on the control panel and select the input source in the input guide.
- 2) Attach the USB memory firmly into the <USB A (VIEWER/WIRELESS)> terminal.
 - The standby screen “please press ENTER” is displayed while the USB memory icon is displayed at the lower left of the screen.
 - When the partition are separated in USB memory, several USB icons will be displayed.
- 3) Press the <ENTER> button on the remote control.
 - The root directory of the USB memory will be displayed in thumbnail on the screen.

Playing the pictures

- 1) Press ▲▼◀▶ on the remote control to select a file you want to play on the memory viewer screen.
- 2) Press the <ENTER> button on the remote control.
 - The picture will display on the full screen.
- 3) Press ▶ to switch to the next picture, press ◀ to return to the previous picture.
- 4) Press the <ENTER> button on the remote control.
 - Return to the thumbnail screen.

Note

- When the recorded number of pixels is smaller than the maximum number of display dot^{*1}, it will be displayed enlarged maintaining the aspect ratio.
- When the recorded number of pixels is larger than the maximum number of display dot^{*1}, it will be displayed reduced maintaining the aspect ratio.
- When the recorded number of pixels is the same as the maximum number of display dot^{*1}, it will neither be enlarged nor reduced, so degradation of image quality can be reduced.

*1 The maximum number of display dot for each product is as follows.

PT-VW360: 1 280 x 800

PT-VX430: 1 024 x 768

Executing the slide

All the still images in the same folder will be played continuously according to the setting of [NETWORK/USB] menu → [MEMORY VIEWER LIGHT].

- 1) Press ▲▼◀▶ on the remote control to select a file.
- 2) Press the <MENU> button to select the [MEMORY VIEWER LIGHT] → [SET SLIDE].
- 3) Press the <ENTER> button on the remote control.
 - The slideshow will start.
 - Press the <ENTER> button to return to the thumbnail screen.

Note

- If you press the <MENU> button during playback in the slideshow, the playback will stop and a menu displays. The playing will continue when the menu disappears.

Termination of the Memory Viewer

- 1) Press ▲▼◀▶ to select the thumbnail  which is displayed on the upper left corner.
- 2) Press the <ENTER> button on the remote control.
 - Return to the standby screen “please press ENTER”.

Note

- You can also exit the Memory Viewer by switching to the input other than MEMORY VIEWER.

USB display function

The USB display function makes it possible to project the image and audio from the computer through a USB converting cable.

When using the USB display function on Mac, the audio output is disabled.

When using on a Windows computer

■ Operating environment

OS	Windows 7 32/64 bit, Windows 8.1 32/64 bit, Windows 10 32/64 bit
CPU	Intel Core 2 Duo 2.0 GHz or faster, the compatible processor
Amount of memory	256 MB or more (Recommended : 512 MB or more)
Hard-disk free space	20 MB or more
Display	Resolution 640 x 480 or more, 1 600 x 1 200 or less

- There is no guarantee for all the computers that meet the above conditions will operate properly.

Projecting the USB display

Note

- The USB display function and the Presenter Light software cannot be used at the same time. Before using the USB display function, terminate the Presenter Light software.

- 1) **Connect the <USB B (DISPLAY)> terminal of the projector to a computer with a USB cable.**
- 2) **Press the <MEMORY VIEWER/USB DISPLAY/NETWORK> button on the remote control or switch the input source to USB DISPLAY.**
 - You can also press the <INPUT SELECT> button on the control panel and select the input source in the input guide.
 - The startup screen will be displayed automatically due to the driver which is built-in the projector, and executing the installation according to the instructions of the screen. The displaying of the auto installation screen is depending on the settings of computer. In this case, please select "Run autorun.exe". Please double-click "autorun.exe" in the folder of the "USB Display" when the automatic startup is disabled.
 - The computer screen is projected.
- 3) **Click the driver icon  in the task tray (bottom right of the computer) and select one item in Pop-up menu.**
 - Pop-up menu is only displayed in English.
 - The item which is displayed in gray is unavailable.

[Active audio] / [Disable audio]	Set whether to output the audio from the computer.
[Play video] / [Pause video]	Switch between playing and pausing the image.
[Start] / [Stop]	Set whether to display the image from the computer.
[Exit]	Displayed in gray and cannot be selected.

Note

- It will take a while when you want to project the computer screen.
- Connect a USB cable directly to the USB connector of a computer. It will not work when connecting through a USB hub.
- At the time that the computer screen is projected, the resolution of the computer may be forcibly changed depending on the combination of computer and projector.

Termination of the USB display

- 1) **When terminating the USB display, remove the USB cable directly.**
 - There is no need to follow "Remove hardware safely" when a USB cable is disconnected.

When using Mac

■ Operating environment

OS	OS X 10.11 macOS 10.12, 10.13
CPU	Intel Core 2 Duo 2.0 GHz or faster
Amount of memory	512 MB or more
Hard-disk free space	20 MB or more
Display	Resolution 640 x 480 or more, 1 600 x 1 200 or less

- There is no guarantee for all the computers that meet the above conditions will operate properly.

Projecting the USB display

- 1) Connect the <USB B (DISPLAY)> terminal of the projector to a computer with a USB cable.
- 2) Press the <MEMORY VIEWER/USB DISPLAY/NETWORK> button on the remote control or switch the input source to USB DISPLAY.
 - You can also press the <INPUT SELECT> button on the control panel and select the input source in the input guide.
 - The virtual disk which is named “USB Display” will be mounted on desktop.
- 3) Double-click “Monitor.app” in the virtual disk that has been mounted.
 - The computer screen is projected.
- 4) Right-click the driver icon  in the dock of computer and select one item in Pop-up menu.
 - The item which is displayed in gray is unavailable.

[Active audio] / [Disable audio]	The audio output is disabled.
[Play video] / [Pause video]	Switch between playing and pausing the image.
[Start] / [Stop]	Set whether to display the image from the computer.
[Options]	Set the items of “Keep in Dock”, “Open at Login” or “Show in Finder”.
[Show All Windows]	Display the background of computer on the full screen temporarily.
[Hide] / [Show]	Set whether to display the USB driver icon.
[Quit]	Terminate the USB display.

Note

- It will take a while when you want to project the computer screen.
- Connect a USB cable directly to the USB connector of a computer. It will not work when connect through a USB hub.
- At the time that the computer screen is projected, the resolution of the computer may be forcibly changed depending on the combination of computer and projector.
- The virtual disk may not be mounted on the desktop depending on your computer. In this case, please open [Finder] and then refer to the “USB Display” in [DEVICES].

Termination of the USB display

- 1) When terminating the USB display, remove the USB cable directly.

Network connection

This projector has network function that allows the following by connecting a computer.

- **Web control**

By accessing to the projector from a computer, you can perform setting, adjustment, status display, etc. of the projector. Refer to “Web control function” (➔ page 99) for details.

- **Multi Monitoring & Control software**

“Multi Monitoring & Control Software”, a software application to monitor and control multiple display devices (projector or flat panel display) connected to intranet, can be used.

Plug-in software “Early Warning Software”, which monitors the status of the display devices and their peripherals within an intranet, and notifies of abnormality of such equipment and detects the signs of possible abnormality, can also be used.

For details, visit the Panasonic website (<https://panasonic.net/cns/projector/>).

- **Image transfer application software**

Using the Panasonic image transfer application software, the image sent from a device can be displayed as a projected image.

For details on how to use the still image transfer application software “Presenter Light” compatible with Windows computers, please refer to the Operating Instructions of “Presenter Light Software”. “Presenter Light Software” can be downloaded by accessing the projector via a web browser. For details, please refer to “About Presenter Light” (➔ page 97). The application software and its operating instructions can be downloaded from our website (<https://panasonic.net/cns/projector/>).

For details of the image transfer application software “Wireless Projector” compatible with the iPad/iPhone/iPod touch or Android device, refer to the Panasonic website (<https://panasonic.net/cns/projector/>).

- **PJLink**

By using PJLink protocol, you can send inquiries about the operations or status of the projector from a computer. Refer to “PJLink protocol” (➔ page 122) for details.

- **Command control**

Operation or status query of the projector can be performed from a computer with the control commands. Refer to “Control commands via LAN” (➔ page 123) for details.

Connecting with wired LAN

Connection example

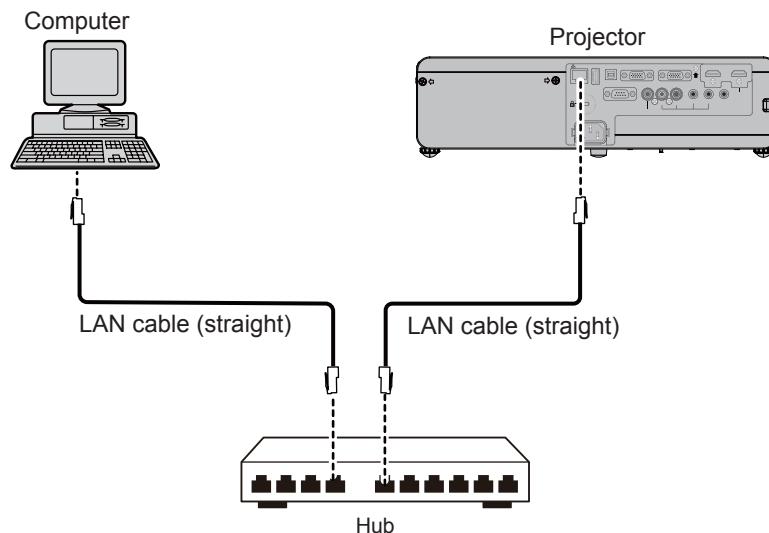

Attention

- When a LAN cable is directly connected to the projector, the network connection must be made indoors.

Note

- A LAN cable is required to use the wired LAN function.
- Use a LAN cable that is straight cable or cross cable and compatible with CAT5 or higher. When you need to know whether to use one or both straight/cross cable depending on the configuration of the system, please confirm with your network administrator. For this projector, it will identify the type of cable (straight/cross) automatically.
- Use a LAN cable of 100 m (328'1") or shorter.

Projector settings

- 1) Use the LAN cable to connect the projector with computer.
- 2) Turn on the projector.
- 3) Select the [NETWORK/USB] menu → [WIRED LAN] from the main menu and press the <ENTER> button.
- 4) Set the detailed setup of [WIRED LAN].
 - For details, please refer to "WIRED LAN" (➡ page 85).

Note

- Please confirm with your network administrator before you connect to an existing network.
- The following settings are set before the projector leaves the factory.

[DHCP]	OFF
[IP ADDRESS]	192.168.10.100
[SUBNET MASK]	255.255.255.0
[DEFAULT GATEWAY]	192.168.10.1
[DNS1]/[DNS2]	NONE

Computer settings

- 1) Turn on the computer.
- 2) Make the network setting according to your system administrator.
 - If the projector settings are the default settings, the computer can be used with the following network settings.

[IP ADDRESS]	192.168.10.101
[SUBNET MASK]	255.255.255.0
[DEFAULT GATEWAY]	192.168.10.1

Connecting with wireless LAN

The wireless module (Model No.: ET-WML100) of the optional accessories is required if you want to use the network function through the wireless LAN.

Connection example

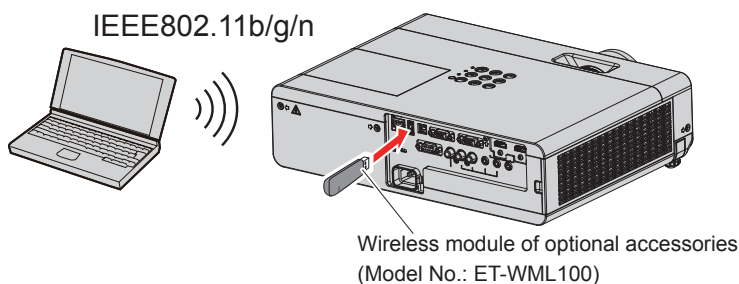

Preparation and confirmation of the projector

- 1) Turn on the projector.
- 2) Attach the wireless module (Model No.: ET-WML100) of optional accessories firmly into the <USB A (VIEWER/WIRELESS)> terminal.

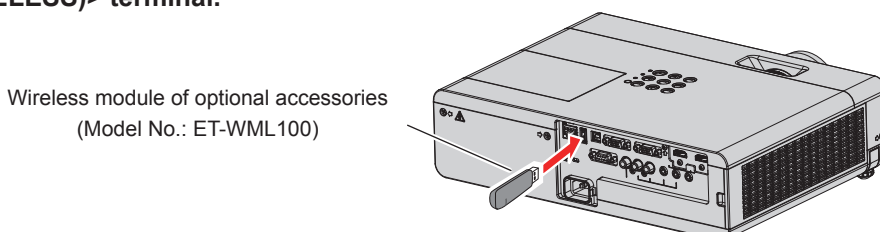

3) Press the <MEMORY VIEWER/USB DISPLAY/NETWORK> button to switch to NETWORK input.

- The network input idle screen is displayed. The login password (a four-digit number that is automatically generated), PROJECTOR NAME, SSID, IP ADDRESS (WIRELESS) and IP ADDRESS (WIRED) will be displayed in the idle screen.
- You can also press the <INPUT SELECT> button on the control panel and the input guide is displayed, then press ▲▼◀▶ to switch to NETWORK input.

Network input idle screen

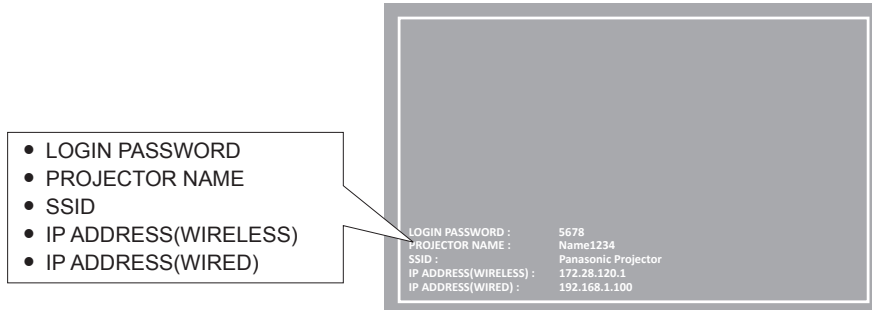

Attention

- Please do not move or transport the projector while the wireless module is attached. Doing so may cause the wireless module to be damaged.
- The indicator of the wireless module will be off when the projector is in standby mode, it will light in blue when the power is turned on and it will blink in blue during wireless communication.
Please do not remove the wireless module while the indicator is blinking.
- When the power of the projector is turned on and the indicator of the wireless module is not lighting/blinking, please insert the wireless module to the <USB A (VIEWER/WIRELESS)> terminal again.
- After turning on the projector, please connect network to the projector after the IP ADDRESS (WIRELESS LAN) is displayed.

Note

- Wireless LAN and wired LAN cannot be used in the same segment.
- The settings of the wireless module are as follows. You can access the projector from the web browser to set the values of [SSID], [CHANNEL] and [ENCRYPTION].

[SSID]	NetworkDisplay
[CHANNEL]	1
[IP ADDRESS]	172.28.120.1
[SUBNET MASK]	255.255.255.0
[DEFAULT GATEWAY]	0.0.0.0
[ENCRYPTION]	Disable

Computer setting

- 1) Turn on the computer.
- 2) Make the network setting according to your system administrator.
 - Please make the network settings for the computer and the projector according to your system administrator.
- 3) Connect to the network that has been set in the projector.
 - If you use a computer, click on the task tray  (bottom right of the computer), then select the same name as the [SSID] that has been set in the projector.

Note

- If you use any wireless LAN connection utility that meets the OS standard, follow the operation instruction of the utility to connect it.

About Presenter Light

The wireless module (Model No.: ET-WML100) of the optional accessories is required if you want to use the network function through the wireless LAN.

By using still image transfer application software “Presenter Light Software” that supports Windows computers, you can transfer images and audio to the projector via the wired LAN or wireless LAN*1.

*1 Sound interruption or noise may occur during image / sound transfer. In such a case, please select mute in the audio setting of the application software.

Download the “Presenter Light” to your computer

- 1) Start up the web browser on the computer.
- 2) Enter the IP address set on the projector into the URL entry field of the web browser.
- 3) Enter the user name and the password.
 - The factory default settings are User name: dispuser (user rights)/dispadmin (administer rights); Password: @Panasonic.

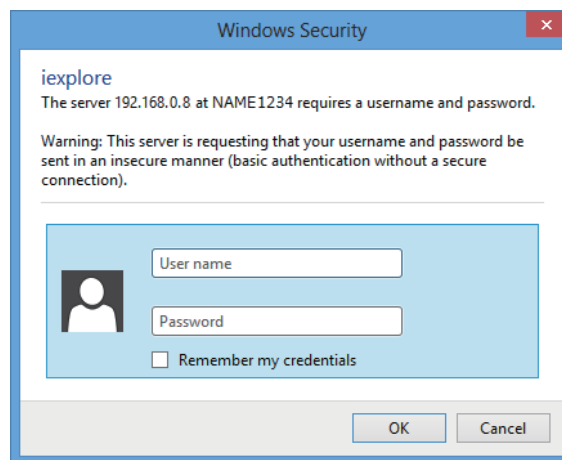

- 4) Click [OK].
 - The [Projector Control Window] page is displayed.

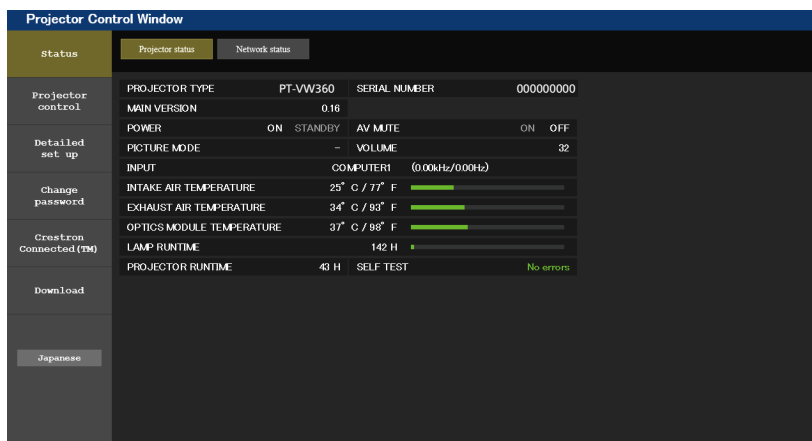

- 5) Click [Download].
 - The download screen of “Presenter Light” is displayed.

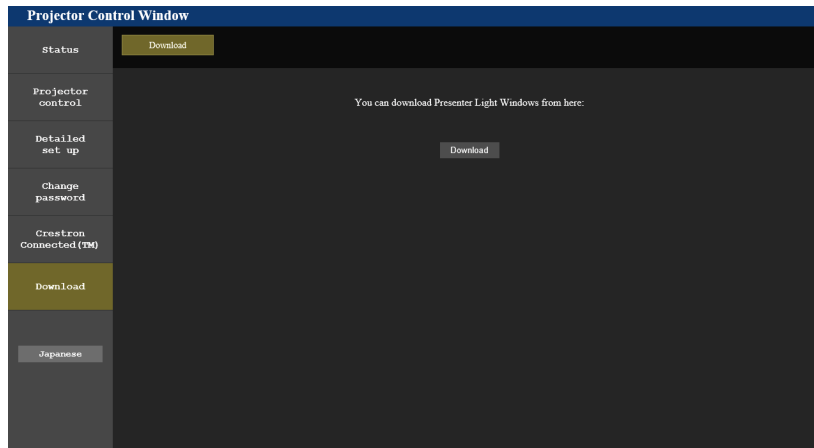

6) Click [Download].

- The download confirmation screen of the executable file “Presenter Light.exe” is displayed.

7) Save “Presenter Light.exe” on the computer desktop.

- This software is used as the executable file format. It cannot be installed in the computer.
- Execute this file when using the software. Please save this software or make a shortcut for convenient use.

Note

- For details about how to use the “Presenter Light Software”, please visit our website (<https://panasonic.net/cns/projector/>).

Web control function

The wireless module (Model No.: ET-WML100) of the optional accessories is required if you want to use the network function through the wireless LAN.

Using web control functions, you can perform the following operations from a computer.

- Setting and adjustment of the projector
- Displaying projector status
- Sending E-mail messages when there is a problem with the projector

The projector supports "Crestron Connected™", and the following application software of Crestron Electronics, Inc. can be used.

- RoomView Express
- Fusion RV
- RoomView Server Edition

Note

- If you use the E-mail function, you need to communicate with the E-mail server. First, please make sure that you can use the E-mail.
- "Crestron Connected™" is a system developed by Crestron Electronics, Inc. which collectively manage and control multiple system devices connected via the network, from a computer. This projector supports "Crestron Connected™".
- For details of "Crestron Connected™", please refer to the website of Crestron Electronics, Inc. (Only in English)
URL <http://www.crestron.com/>
For the download of "RoomView Express", please refer to the website of Crestron Electronics, Inc. (Only in English)
URL <http://www.crestron.com/getroomview>

Computer that can be used

In order to use the web control function, a web browser is required. Confirm that the web browser can be used beforehand.

OS	Compatible web browser
Windows	Internet Explorer 11.0 Microsoft Edge
Mac OS	Safari 8.0/9.0/10.0

Accessing from the web browser

- 1) Start up the web browser on the computer.
- 2) Enter the IP address set on the projector into the URL entry field of the web browser.
- 3) Enter the user name and the password.
 - The factory default settings are User name: dispuser (user rights)/dispadmin (administer rights); Password: @Panasonic.

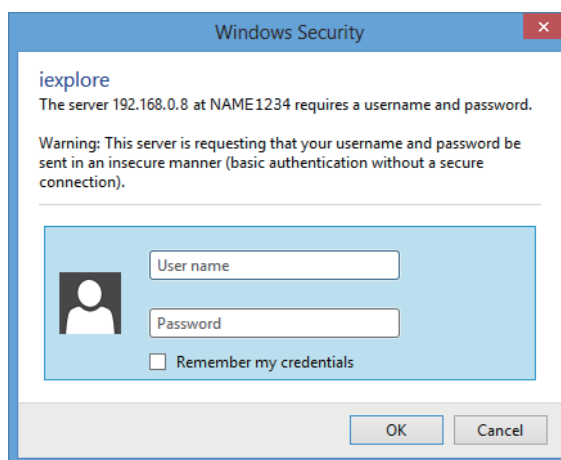

- 4) Click [OK].
 - The [Projector Control Window] page is displayed.

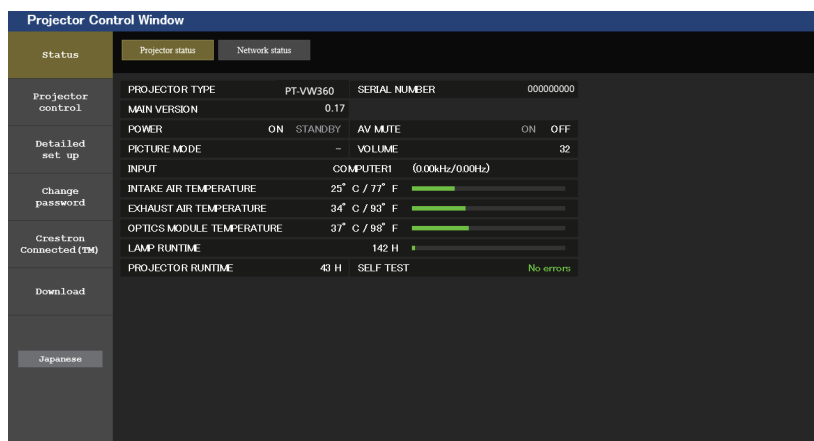

Note

- If you use a web browser to control the projector, set [NETWORK CONTROL] in the [NETWORK/USB] menu to [ON] (➔ page 86).
- Do not perform setting or control simultaneously by starting up multiple web browsers. Do not set or control the projector from multiple computers.
- Change the password first. (➔ page 110)
- Access will be locked for few minutes when an incorrect password is entered three times consecutively.
- Some items on the projector setting page use the Javascript function of the web browser. The projector may not be able to be controlled properly if it is set with a browser that does not have this function enabled.
- If the screen for the web control is not displayed, consult your network administrator.
- While updating the screen for the web control, the screen may become white for a moment, but it is not a malfunction.
- About computer screen illustrations
The subsequent web control screens show examples for PT-VW360. Screen content may differ from that for the projector model you are using. In addition, the screen size and the display may differ from this manual depending on the OS, web browser or the type of computer you are using.

Available functions per account

With the administrator rights, all functions can be used. With the user rights, available functions are restricted. Select an account according to the purpose of use.

- ✓: The operation can be performed.
- : The operation cannot be performed.

Item	Function	Administrator rights	User rights	Page
[Status]	[Projector status]	✓	✓	101
	Error information page	✓	✓	102
	[Network status]	✓	✓	102
[Projector control]	[Basic control]	✓	✓	103
	[Detail control]	✓	✓	103
[Detailed set up]	[Network config]	✓	—	104
	[Ping test]	✓	—	105
	[ECO management set up]	✓	—	105
	[E-mail set up]	✓	—	106
	[Authentication set up]	✓	—	107
	[Port set up]	✓	—	109
[Change password]	User name of [Administrator]	✓	—	110
	User name of [User]	✓	—	111
	Password of [Administrator]	✓	—	110
	Password of [User]	✓	✓	111
[Crestron Connected(TM)]	Control page	✓	—	112
	[Tools]	✓	—	112
	[Info]	✓	—	113
	[Help]	✓	—	113
[Download]	Download Presenter Light	✓	✓	97

Descriptions of items

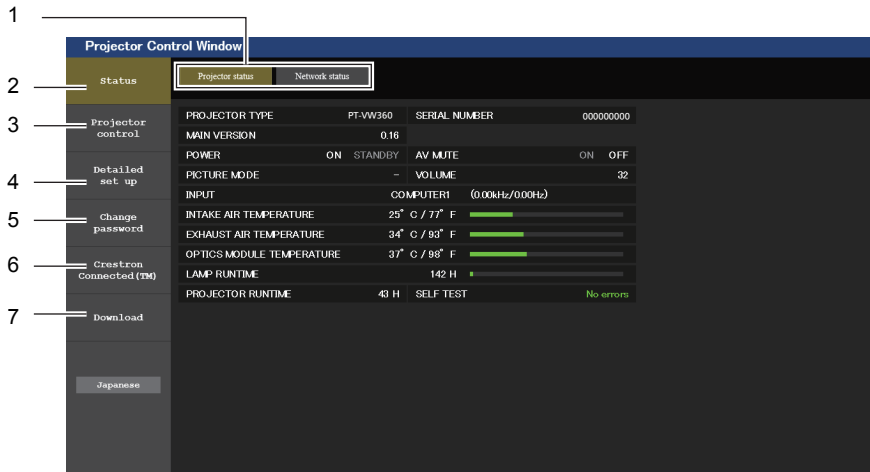

- 1 **Page tab**
Pages are switched by clicking this item.
- 2 **[Status]**
The status of the projector is displayed by clicking this item.
- 3 **[Projector control]**
The [Projector control] page is displayed by clicking this item.
- 4 **[Detailed set up]**
The [Detailed set up] page is displayed by clicking this item.
- 5 **[Change password]**
The [Change password] page is displayed by clicking this item.
- 6 **[Crestron Connected(TM)]**
The control page of Crestron Connected™ is displayed by clicking this item.
- 7 **[Download]**
The download page of Presenter Light software is displayed by clicking this item. (➔ page 97)

[Projector status] page

Click [Status] → [Projector status].

Display the status of the projector for the following items.

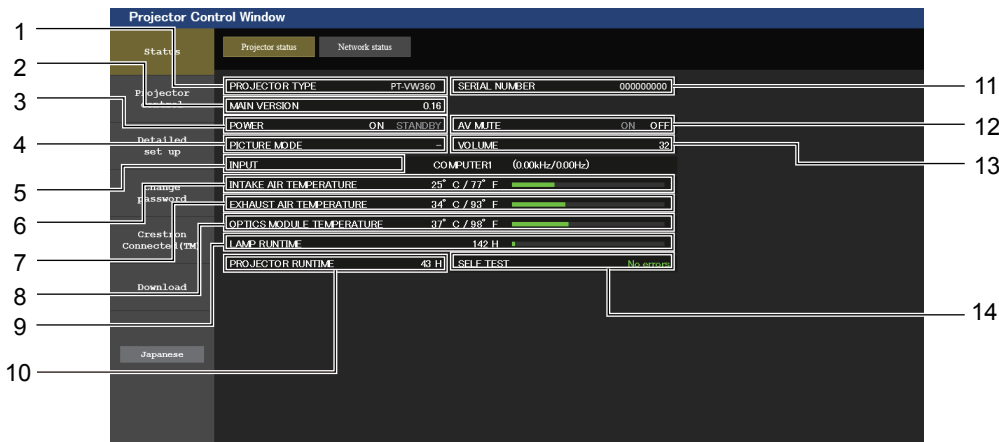

- 1 **[PROJECTOR TYPE]**
Displays the type of the projector.
- 2 **[MAIN VERSION]**
Displays the firmware version of the projector.
- 3 **[POWER]**
Displays the status of the power.
- 4 **[PICTURE MODE]**
Displays the setting status of [PICTURE MODE].
- 5 **[INPUT]**
Displays the status of the selected input.
- 6 **[INTAKE AIR TEMPERATURE]**
Displays the status of the air intake temperature of the projector.
- 7 **[EXHAUST AIR TEMPERATURE]**
Displays the status of the exhaust air temperature of the projector.
- 8 **[OPTICS MODULE TEMPERATURE]**
Displays the status of the optics module temperature of the projector.
- 9 **[LAMP RUNTIME]**
Displays the runtime of the luminous lamps (converted value).
- 10 **[PROJECTOR RUNTIME]**
Displays the runtime of the projector.
- 11 **[SERIAL NUMBER]**
Displays the serial number of the projector.
- 12 **[AV MUTE]**
Displays the status of the AV mute.
- 13 **[VOLUME]**
Displays the volume status.
- 14 **[SELF TEST]**
Displays the self-diagnosis information.

Error information page

When [Error (Detail)] or [Warning (Detail)] is displayed in the self-diagnosis display of the [Projector status] screen, click it to display the error/warning details.

- The projector may go into the standby status to protect the projector depending on the contents of the error.



1 Self-diagnosis result display

Displays the item check results.

[OK]: Indicates that operation is normal.

[FAILED]: Indicates that there is a problem.

[WARNING]: Indicates that there is a warning.

■ [FAILED] items displayed when a problem occurs

Parameter	Description
[FAN]	Trouble has occurred in the fan or its drive circuit. Consult your dealer.
[FAN(INTAKE)]	Trouble has occurred in the intake fan.
[FAN(LAMP)]	Trouble has occurred in the luminous lamp cooling fan.
[FAN(EXHAUST)]	Trouble has occurred in the exhaust fan.
[INTAKE AIR TEMPERATURE]	The air intake temperature is too high. The projector may be used in an operating environment where the temperature is high, such as near a heating appliance.
[EXHAUST AIR TEMPERATURE]	The exhaust air temperature is high. The air exhaust port may be blocked.
[OPTICS MODULE TEMPERATURE]	The temperature around the optics module inside the projector is high. The projector may be used in an operating environment where the temperature is high, such as near a heating appliance.
[LAMP REMAIN TIME]	The luminous lamp runtime has exceeded the prescribed cumulative time, and it is now time to replace the luminous lamp.
[LAMP STATUS]	The luminous lamp has failed to light. Wait a short while for the luminous lamp to cool off, and then turn on the power.
[APERTURE (CONTRAST-SHUTTER)]	Trouble has occurred in the contrast shutter circuitry. Consult your dealer.
[INTAKE AIR TEMP.SENSOR]	Trouble has occurred in the sensor used to detect intake air temperature. Consult your dealer.
[OPTICS MODULE SENSOR]	Trouble has occurred in the optics module sensor. Consult your dealer.
[EXHAUST AIR TEMP.SENSOR]	Trouble has occurred in the sensor used to detect exhaust air temperature. Consult your dealer.
[AIR FILTER]	There is too much dust accumulated in the air filter unit. Turn off the projector and unplug the power plug from the wall outlet, then replace the air filter unit.
[COVER OPEN]	The cover is open.

[Network status] page

Click [Status] → [Network status].

The current network setting status is displayed.

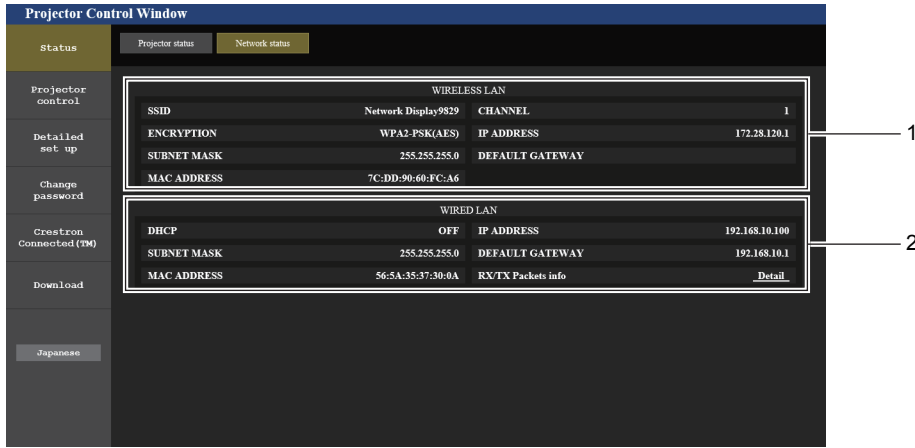

1 [WIRELESS LAN]

Displays the configuration details of wireless LAN.

2 [WIRED LAN]

Displays the configuration details of wired LAN.

[Basic control] page

Click [Projector control] → [Basic control].



1 [INPUT]

Switches the image input to be projected.

2 [VOLUME]

Adjusts the volume level.

3 [PICTURE MODE]

Switches the picture mode.

4 [AV MUTE]

Switches between AV mute on/off.

5 [POWER]

Turns on/off the power.

6 [CLOSED CAPTION]

Switches the closed caption mode.

[Detail control] page

Click [Projector control] → [Detail control].

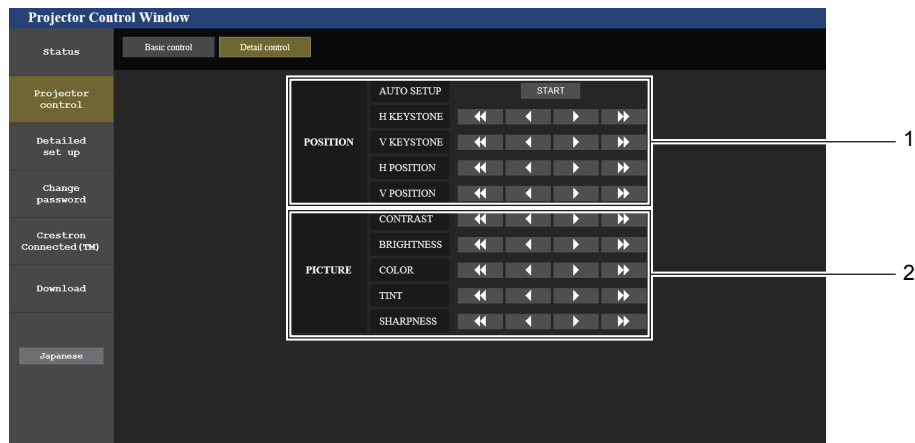

1 [POSITION]

Operates field angle-related settings.

2 [PICTURE]

Operates picture quality settings.

[Network config] page

Click [Detailed set up] → [Network config].

- 1) Click [Network config].
 - The [CAUTION!] screen is displayed.

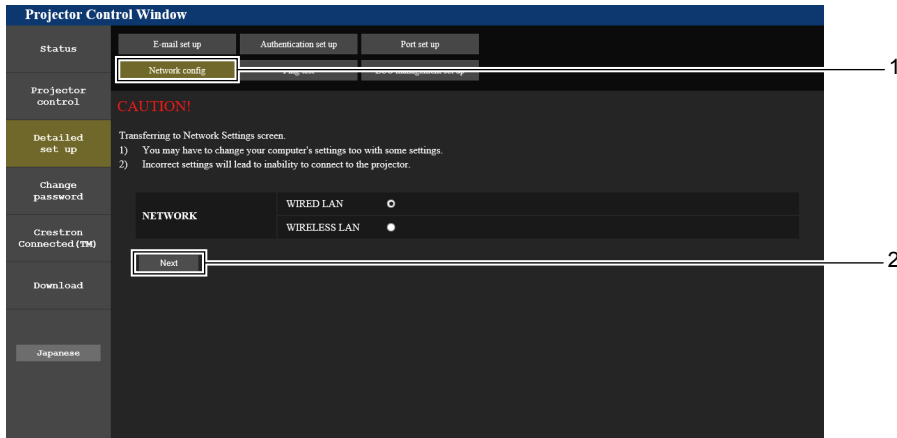

- 2) Select the item which you want to change the setting, then click [Next].
 - The current setting is displayed.
- 3) Click [Change] button.
 - The setting change screen is displayed.

Wired LAN

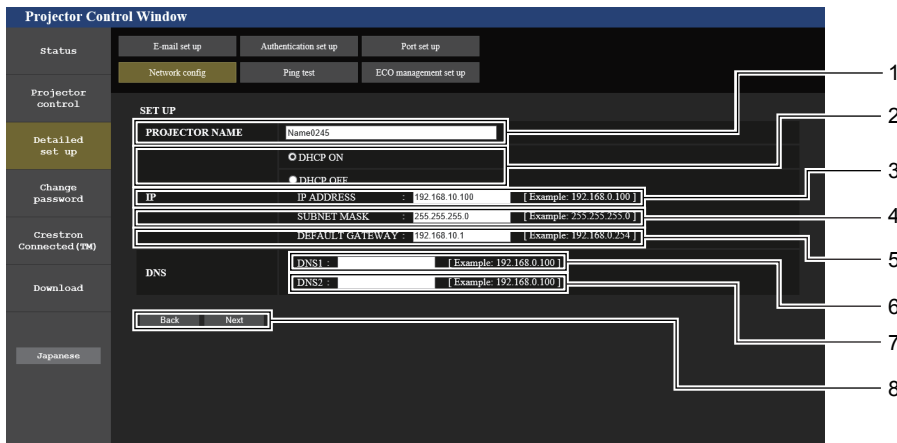

- | | |
|--|---|
| <ol style="list-style-type: none"> 1 [PROJECTOR NAME]
Enters the name of the projector. Enter the host name if it is required when using a DHCP server etc. 2 [DHCP ON], [DHCP OFF]
Sets to [DHCP ON] to enable the DHCP client function. 3 [IP ADDRESS]
Enters the IP address when not using a DHCP server. 4 [SUBNET MASK]
Enters the subnet mask when not using a DHCP server. 5 [DEFAULT GATEWAY]
Enters the default gateway address when not using a DHCP server. | <ol style="list-style-type: none"> 6 [DNS1]
Enters the DNS1 server address.
Permissible characters for the entry of DNS1 server address (preferred):
Numbers (0 - 9), period (.)
(Example: 192.168.0.253) 7 [DNS2]
Enters the DNS2 server address.
Permissible characters for the entry of DNS2 server address (alternate):
Numbers (0 - 9), period (.)
(Example: 192.168.0.254) 8 [Back], [Next]
Click the [Back] button to return to the original screen. The current settings are displayed by pressing the [Next] button.
Click the [Submit] button to update the settings. |
|--|---|

Note

- When you use the “Forward” and “Back” functions of your browser, a warning message “Page has Expired” may appear. In that case, click [Network config] again since the following operation will not be guaranteed.
- Changing LAN settings while connected to the LAN may cause the connection to cut out.

Wireless LAN

(Only when the wireless module is attached)

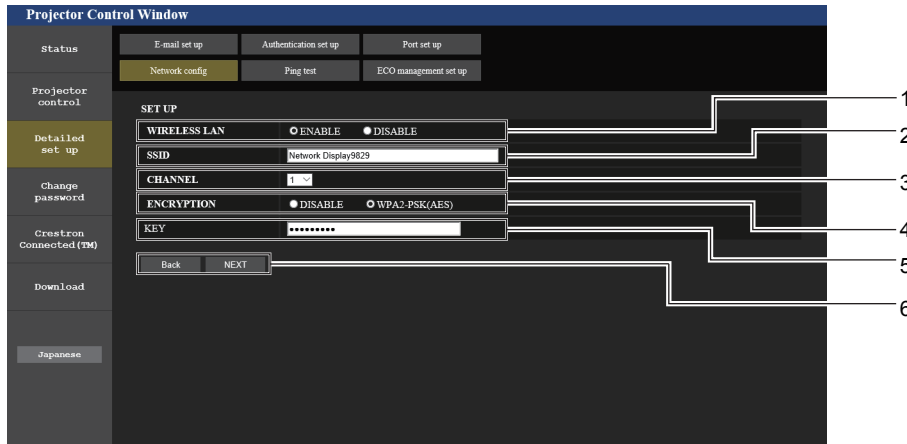

- | | |
|---|--|
| <p>1 [WIRELESS LAN]
Selects [Enable] when you want to enable the wireless LAN function.</p> <p>2 [SSID]
Sets the SSID for use.</p> <p>3 [CHANNEL]
Selects the channel for use.</p> | <p>4 [ENCRYPTION]
Selects [WPA2-PSK(AES)] when performing encrypted communications.</p> <p>5 [KEY]
Sets the key to be used when performing encrypted communications.
8 to 15 alphanumeric can be input.</p> <p>6 [Back], [Next]
Click the [Back] button to return to the original screen. The current settings are displayed by pressing the [Next] button.</p> |
|---|--|

Note

- Changing LAN settings while connected to the LAN may cause the connection to cut out.
- The setting values of the [Network config] page will return to the factory default when the [INITIALIZE] of the [NETWORK/USB] menu is executed (➔ page 88).
- The [ENCRYPTION] is set to [DISABLE] in the factory default setting. If you want to communicate with wireless LAN, it is recommended that the [ENCRYPTION] is set to [WPA2-PSK (AES)] for security.

[Ping test] page

Check whether the network is connected to the E-mail server, POP server, DNS server, etc.
Click [Detailed set up] → [Ping test].

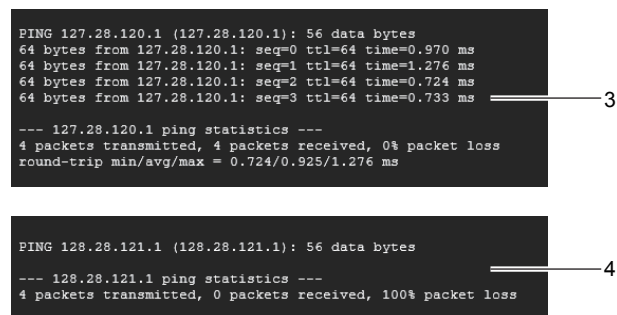
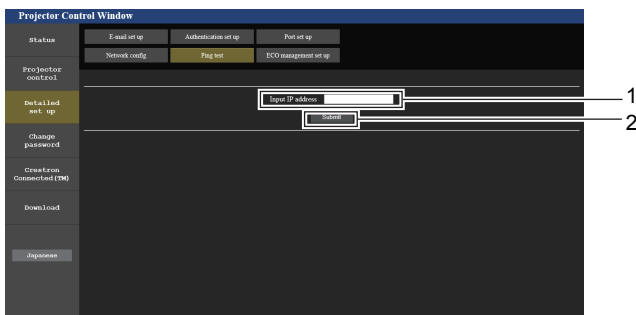

- | | |
|---|--|
| <p>1 [Input IP address]
Enter the IP address of the server to be tested.</p> <p>2 [Submit]
Execute the connection test.</p> | <p>3 Example of display when the connection has succeeded</p> <p>4 Example of display when the connection has failed</p> |
|---|--|

[ECO management set up] page

Settings related to the ECO management function of the projector can be made.
Click [Detailed set up] → [ECO management set up].

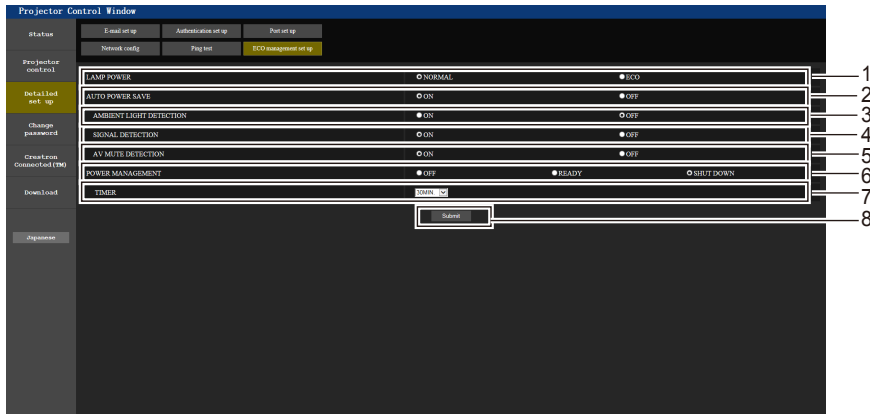

- | | |
|---|--|
| <p>1 [LAMP POWER]
Selects the [LAMP POWER] setting.</p> <p>2 [AUTO POWER SAVE]
Sets to [ON] when setting [SIGNAL DETECTION] and [AV MUTE DETECTION].</p> <p>3 [AMBIENT LIGHT DETECTION]
Selects to enable ([ON])/disable ([OFF]) the environmental luminance interlock function.</p> <p>4 [SIGNAL DETECTION]
Selects to enable ([ON])/disable ([OFF]) the no signal interlock function.</p> | <p>5 [AV MUTE DETECTION]
Selects to enable ([ON])/disable ([OFF]) the AV MUTE detection function.</p> <p>6 [POWER MANAGEMENT]
Selects the power consumption mode.</p> <p>7 [TIMER]
Selects the time that the lamp is turned off when the POWER MANAGEMENT function is using.</p> <p>8 [Submit]
Updates the settings.</p> |
|---|--|

Note

- For details of each setting item, refer to the [PROJECTOR SETUP] menu → [ECO MANAGEMENT] (➔ page 76) on the projector.

[E-mail set up] page

When there is a problem or the runtime of a luminous lamp reaches a set value, an E-mail can be sent to preset E-mail addresses (up to two addresses).

Click [Detailed set up] → [E-mail set up].

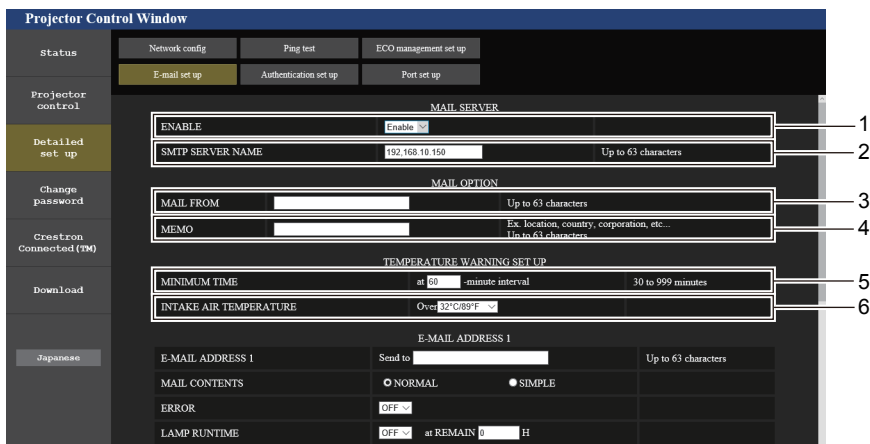

- | | |
|---|---|
| <p>1 [ENABLE]
Select [Enable] to use the E-mail function.</p> <p>2 [SMTP SERVER NAME]
Enter the IP address or the server name of the E-mail server (SMTP). To enter the server name, the DNS server needs to be set up.</p> <p>3 [MAIL FROM]
Enter the E-mail address of the projector. (Up to 63 characters in single byte)</p> <p>4 [MEMO]
Enter information such as the location of the projector that notifies the sender of the E-mail. (Up to 63 characters in single byte)</p> | <p>5 [MINIMUM TIME]
Change the minimum interval for the temperature warning E-mail. The default value is 60 minutes. In this case, another E-mail will not be sent for 60 minutes after sending the temperature warning E-mail even if it reaches the warning temperature.</p> <p>6 [INTAKE AIR TEMPERATURE]
Change the temperature setting for the temperature warning mail. A temperature warning E-mail is sent when the temperature exceeds this value.</p> |
|---|---|

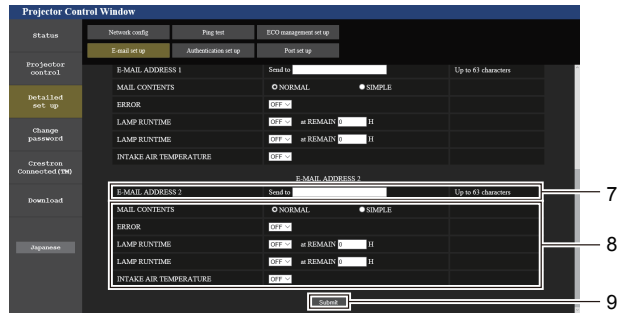
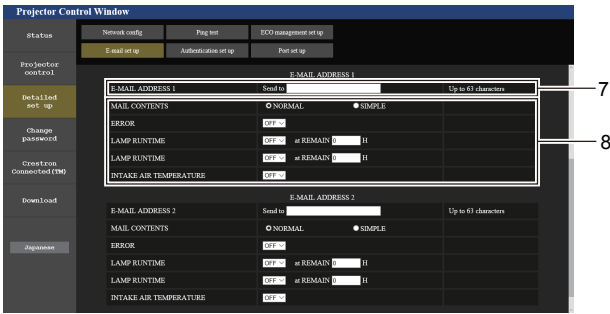

- 7 **[E-MAIL ADDRESS 1], [E-MAIL ADDRESS 2]**
Enter the E-mail address to be sent. Leave [E-MAIL ADDRESS 2] blank when two E-mail addresses are not to be used.
- 8 **Settings of the conditions to send E-mail**
Selects the conditions to send E-mail.
[MAIL CONTENTS]:
Selects either [NORMAL] or [SIMPLE].
[ERROR]:
Sends an E-mail when an error has occurred in the self-diagnosis.

[LAMP RUNTIME]:
Sends an E-mail when the remaining time for the luminous lamp has reached the value set at the right field.

[INTAKE AIR TEMPERATURE]:
Sends an E-mail when the air intake temperature has reached the value set at the above field.

- 9 **[Submit]**
Updates the settings.

[Authentication set up] page

Set the authentication items when POP authentication or SMTP authentication is necessary to send an E-mail. Click [Detailed set up] → [Authentication set up].

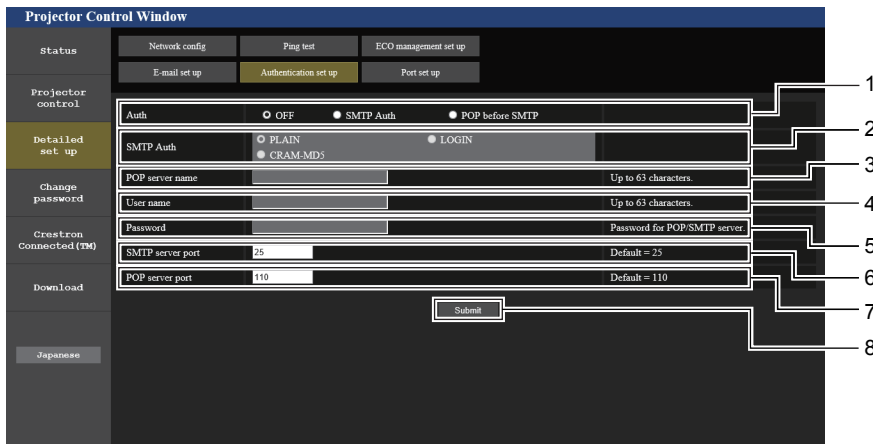

- 1 **[Auth]**
Selects the authentication method specified by your Internet service provider.
- 2 **[SMTP Auth]**
Set when the SMTP authentication is selected.
- 3 **[POP server name]**
Enter the POP server name.
Allowed characters:
Alphanumerics (A - Z, a - z, 0 - 9)
Minus sign (-) and period (.)
- 4 **[User name]**
Enter the user name for the POP server or the SMTP server.

- 5 **[Password]**
Enter the password for the POP server or the SMTP server.
- 6 **[SMTP server port]**
Enter the port number of the SMTP server. (Normally 25)
- 7 **[POP server port]**
Enter the port number of the POP server. (Normally 110)
- 8 **[Submit]**
Updates the settings.

Contents of E-mail sent

Example of E-mail sent when E-mail is set

The following E-mail is sent when the E-mail settings have been established.

```
=== Panasonic projector report(CONFIGURE) ===
Projector Type      : PT-VW360
Serial No          : 000000000
----- E-mail setup data -----
TEMPERATURE WARNING SETUP
MINIMUM TIME       at [ 30] minutes interval
INTAKE AIR TEMPERATURE Over [ 32 degC / 89 degF ]

ERROR              [ OFF ]
LAMP RUNTIME       [ OFF ]   at REMAIN [ 0] H
LAMP RUNTIME       [ OFF ]   at REMAIN [ 0] H
INTAKE AIR TEMPERATURE [ ON ]

----- check system -----
FAN                 [ OK ]
INTAKE AIR TEMPERATURE [ OK ]
EXHAUST AIR TEMPERATURE [ OK ]
OPTICS MODULE TEMPERATURE [ OK ]
LAMP REMAIN TIME     [ OK ]
LAMP STATUS          [ OK ]
APERTURE (CONTRAST-SHUTTER) [ OK ]
INTAKE AIR TEMP.SENSOR [ OK ]
OPTICS MODULE SENSOR [ OK ]
EXHAUST AIR TEMP.SENSOR [ OK ]
AIR FILTER           [ OK ]
COVER OPEN           [ OK ]

(Error code 00 00 00 00 00 00 00 00)

Intake air temperature : 36 degC / 96 degF
Exhaust air temperature : 33 degC / 91 degF
Optics module temperature : 34 degC / 93 degF

PROJECTOR RUNTIME      5 H

LAMP ECO              0 H
LAMP NORMAL           0 H
LAMP REMAIN           5000 H

----- Current status -----
MAIN VERSION          0.16
SUB VERSION           0.03
LAMP STATUS           LAMP=ON
INPUT                 USB DISPLAY

----- Wired Network configuration -----
DHCP Client          OFF
IP address           192.168.22.100
MAC address          00:0E:00:00:00:00

----- Memo -----
```

Example of the E-mail sent for an error

The following E-mail is sent when an error has occurred.

```

=== Panasonic projector report(ERROR) ===
Projector Type       : PT-VW360
Serial No           : 000000000
----- check system -----
FAN                 [ OK ]
INTAKE AIR TEMPERATURE [ OK ]
EXHAUST AIR TEMPERATURE [ OK ]
OPTICS MODULE TEMPERATURE [ OK ]
LAMP REMAIN TIME    [ OK ]
LAMP STATUS         [ OK ]
APERTURE (CONTRAST-SHUTTER) [ OK ]
INTAKE AIR TEMP.SENSOR [ OK ]
OPTICS MODULE SENSOR [ OK ]
EXHAUST AIR TEMP.SENSOR [ OK ]
AIR FILTER          [ OK ]
COVER OPEN          [ FAILED ]

(Error code 00 00 00 02 00 00 00 00)

Intake air temperature : 28 degC / 82 degF
Exhaust air temperature : 34 degC / 93 degF
Optics module temperature : 38 degC / 100 degF

PROJECTOR RUNTIME      16 H

LAMP ECO               0 H
LAMP NORMAL            7 H
LAMP REMAIN            4987 H

----- Current status -----
MAIN VERSION          0.18
SUB VERSION           0.03
LAMP STATUS           LAMP=OFF

INPUT                 HDMI1

----- Wired Network configuration -----
DHCP Client          ON
IP address           192.168.22.100
MAC address          00:0E:00:00:00:00

----- Memo -----

```

[Port set up] page

Set the port number used for command control.

Click [Detailed set up] → [Port set up].

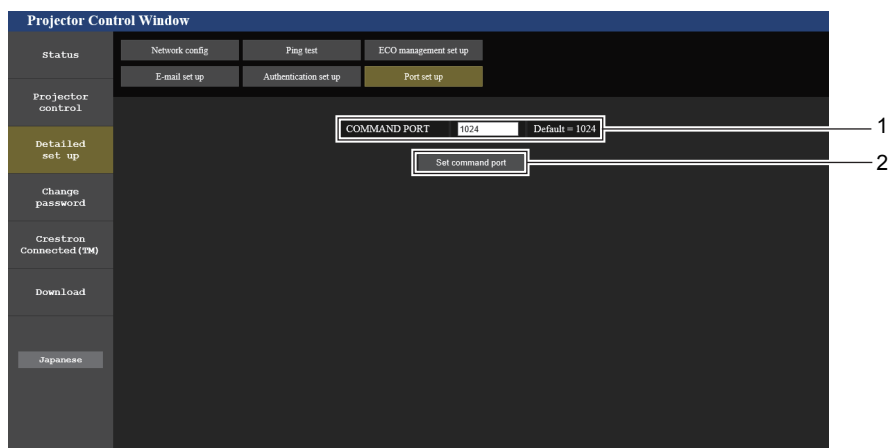

1 [COMMAND PORT]
Set the port number used for command control.

2 [Set command port]
Update the settings.

[Change password] page

Click [Change password].

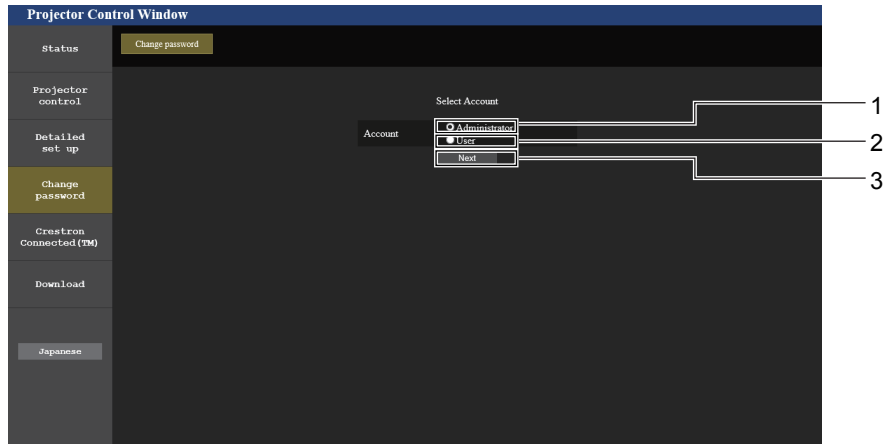

- 1 **[Administrator]**
Used to change the setting of the [Administrator].
- 2 **[User]**
Used to change the setting of the [User].
- 3 **[Next]**
Used to display the screen for changing the password.

[Administrator] account

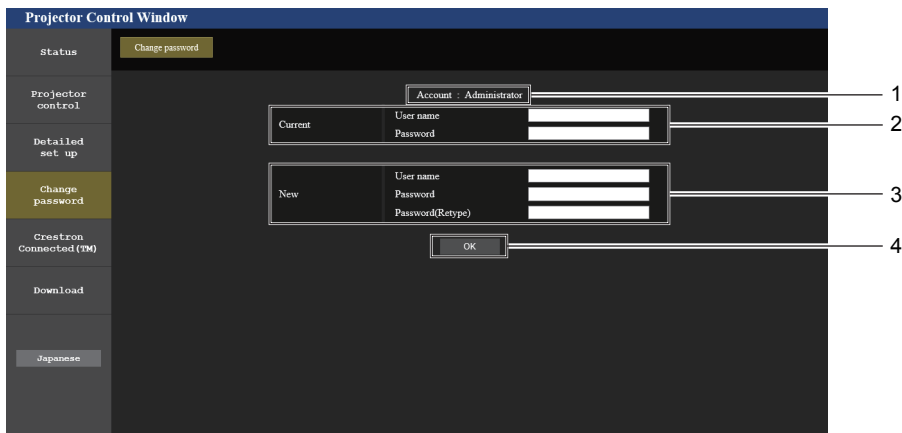

- 1 **[Account : Administrator]**
Displays the account to change.
- 2 **[Current]**
[User name]:
Enter the user name before the change.
[Password]:
Enter the current password.
- 3 **[New]**
[User name]:
Enter the desired new user name. (Up to 16 characters in single byte)
[Password]:
Enter the desired new password. (Up to 16 characters in single byte)
[Password(Retyp)]:
Enter the desired new password again.
- 4 **[OK]**
Determines the change of password.

[User] account

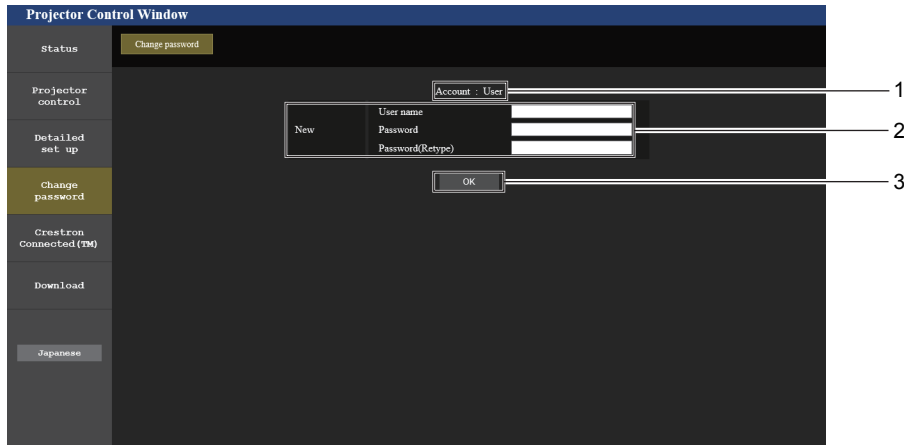

- | | |
|---|---|
| <p>1 [Account : User]
Displays the account to change.</p> <p>2 [New]
[User name]:
Enter the desired new user name. (Up to 16 characters in single byte)
[Password]:
Enter the desired new password. (Up to 16 characters in single byte)
[Password(Retype)]:
Enter the desired new password again.</p> | <p>3 [OK]
Determines the change of password.</p> |
|---|---|

[Change password] (For user rights)

The change of password is enabled only under the user rights.

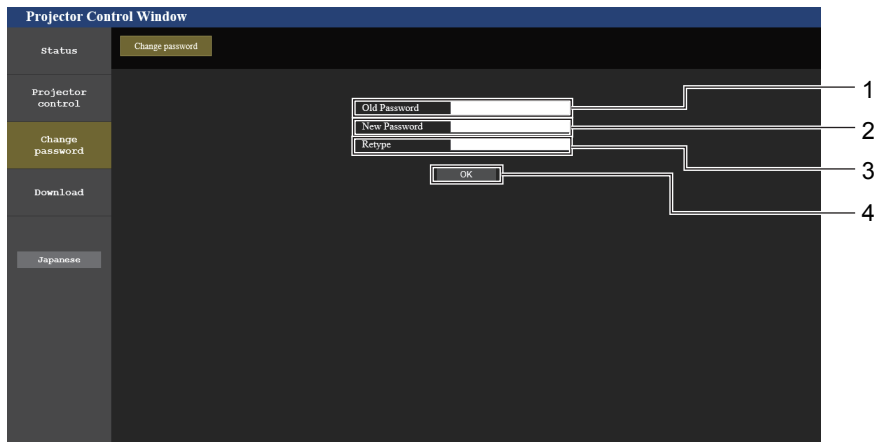

- | | |
|--|--|
| <p>1 [Old Password]
Enter the current password.</p> <p>2 [New Password]
Enter the desired new password. (Up to 16 characters in single byte)</p> | <p>3 [Retype]
Enter the desired new password again.</p> <p>4 [OK]
Determines the change of password.</p> |
|--|--|

Note

- To change the account of the administrator, you must enter the [User name] and the [Password] in [Current].

[Crestron Connected(TM)] page

The projector can be monitored/controlled with Crestron Connected™.

To start the control page of Crestron Connected™ from the web control screen, you need to access with the administrator rights. (For user rights, the [Crestron Connected(TM)] button is not displayed on the web control screen.)

The control page of Crestron Connected™ is displayed by clicking [Crestron Connected(TM)].

It is not displayed if Adobe® Flash® Player is not installed on the computer used, or the browser used does not support Flash. In that case, click [Back] on the control page to go back to the previous page.

Control page



- | | |
|---|--|
| <p>1 [Tools], [Info], [Help]
Tabs for selecting the setting, information, or help page of the projector.</p> <p>2 [POWER]
Turns off/on the power.</p> <p>3 [VOL DOWN], [VOL UP]
Adjusts the volume.
[AV MUTE]
Switches on/off the AV mute function.</p> | <p>4 [Input Select]
Controls input selection.
Not available when the power of the projector is turned off.</p> <p>5 Menu screen control buttons
Navigates the menu screen.</p> <p>6 Freeze/Contrast/Brightness/Color/Digital Zoom
Controls items related to freeze/image quality/digital zoom.</p> <p>7 [Back]
Performs return to the previous page.</p> |
|---|--|

[Tools] page

Click [Tools] on the control page.

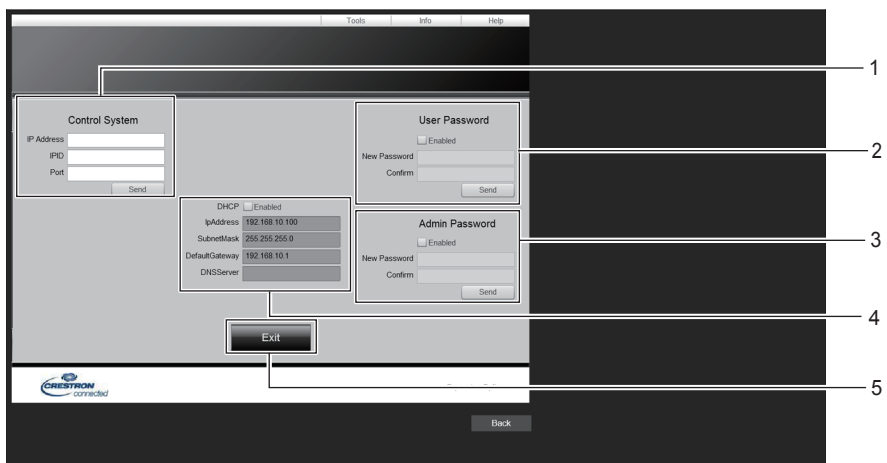

- | | |
|--|--|
| <p>1 [Control System]
Sets the information required for communicating with the controller to be connected with the projector.</p> <p>2 [User Password]
Sets the user rights password for the Crestron Connected™ control page.</p> <p>3 [Admin Password]
Sets the administrator rights password for the Crestron Connected™ control page.</p> | <p>4 Network status
Displays the settings of wired LAN.
[DHCP]
Displays the current setting.
[IpAddress]
Displays the current setting.
[SubnetMask]
Displays the current setting.
[DefaultGateway]
Displays the current setting.
[DNSServer]
Displays the current setting.</p> <p>5 [Exit]
Returns to the control page.</p> |
|--|--|

[Info] page

Click [Info] on the control page.

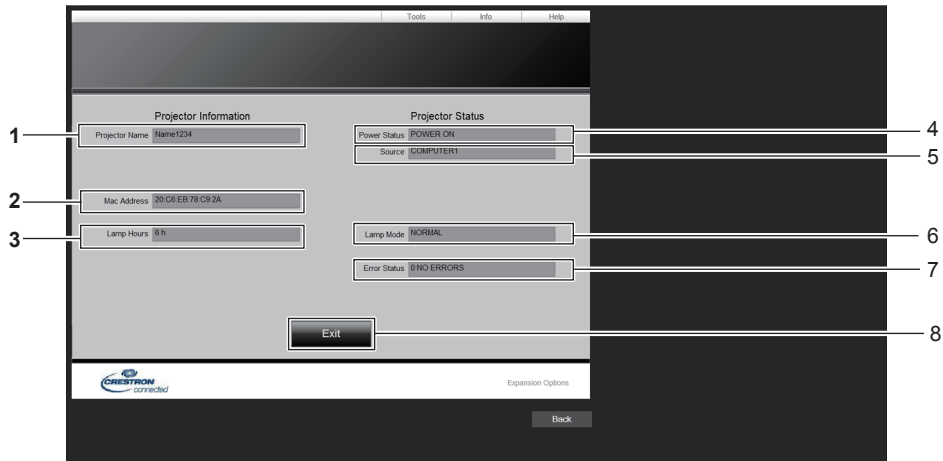

- | | |
|---|--|
| <p>1 [Projector Name]
Displays the projector name.</p> <p>2 [Mac Address]
Displays the MAC address.</p> <p>3 [Lamp Hours]
Displays the runtime of the luminous lamps (converted value).</p> <p>4 [Power Status]
Displays the status of the power.</p> | <p>5 [Source]
Displays the selected input.</p> <p>6 [Lamp Mode]
Displays the setting status of [LAMP POWER].</p> <p>7 [Error Status]
Displays the error status.</p> <p>8 [Exit]
Returns to the control page.</p> |
|---|--|

[Help] page

Click [Help] on the control page.
The [Help Desk] window is displayed.

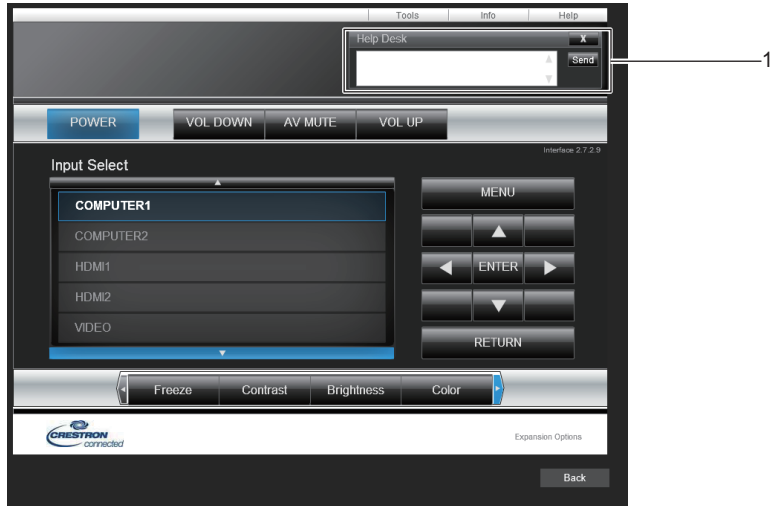

- 1 [Help Desk]**
Send/receive messages to/from an administrator who uses Crestron Connected™.

Chapter 6 Maintenance

This chapter describes methods of inspection when there are problems, maintenance, and replacement of the units.

Lamp and Warning Indicators

When an indicator lights up

If a problem should occur inside the projector, the lamp indicator <LAMP> and the warning indicator <WARNING> will inform you by lighting or blinking. Check the status of the indicators and remedy the indicated problems as follows.

Attention

- Before you take a remedial measure, follow the procedure of switching the power off indicated in “Powering off the projector”. (➔ page 42)

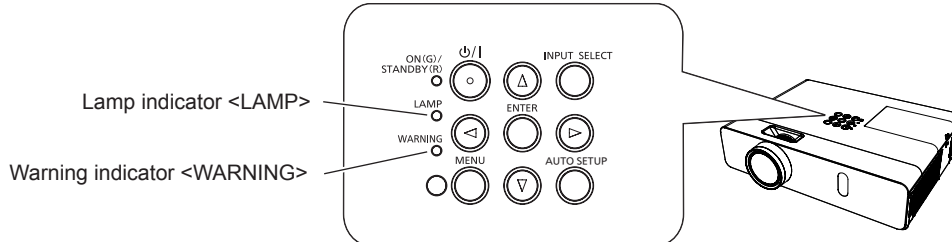

Lamp indicator <LAMP>

Indicator status	Lighting in red	Blinking in red	
Status	Time to replace the lamp unit. (➔ page 118)	A problem is detected in the luminous lamp or the power supply for the luminous lamp.	
Check	<ul style="list-style-type: none"> • Was [REPLACE LAMP] displayed when you turned on the power? • The indicator lights up when the total runtime (converted time) of the luminous lamp unit has reached 5 000 hours. 	<ul style="list-style-type: none"> • Have you turned on the power again immediately after turning it off? 	<ul style="list-style-type: none"> • Some error has occurred in the lamp circuit. Check for fluctuation (or drop) in the source voltage.
Remedy	<ul style="list-style-type: none"> • Replace the lamp unit. 	<ul style="list-style-type: none"> • Wait a while until the luminous lamp cools off, and then turn on the power. 	<ul style="list-style-type: none"> • Turn off the projector, and unplug the AC power cord, and consult your dealer.

Note

- If the lamp indicator <LAMP> is still lighting or blinking after taking the preceding measures, ask your dealer for repair.

Warning indicator <WARNING>

Indicator status	Lighting in red	Blinking in red	Blinking in red (Slow)
Status	The air filter is clogged, or the internal temperature is high (warning).	The air filter is clogged, or the internal temperature is high (standby status).	The projector detects an abnormal condition and cannot be turned on.
Check	<ul style="list-style-type: none"> • Is the air intake/exhaust port blocked? • Is the room temperature high? • Is the air filter unit dirty? 		—
Remedy	<ul style="list-style-type: none"> • Remove any objects that are blocking the air intake / exhaust port. • Install the projector in a location with an ambient temperature of 0 °C (32 °F) to 40 °C (104 °F)*1. • Do not use the projector at high altitudes of 2 700 m (8 858') or higher above sea level. • Replace the air filter unit. (➔ page 116) 		<ul style="list-style-type: none"> • If the projector is turned off again, unplug the AC power cord and contact the dealer or the service center for service and checkup.

*1 When using the projector at high altitudes (between 1 400 m (4 593') and 2 700 m (8 858') above sea level), the ambient temperature should be between 0 °C (32 °F) and 30 °C (86 °F).

Note

- If the warning indicator <WARNING> is still lighting or blinking after taking the preceding measures, ask your dealer for repair.

Maintenance/replacement

Before performing maintenance/replacement

- When you perform maintenance or replacement of the parts, make sure to turn off the power and disconnect the power plug from the wall outlet. (➔ pages 38)
- Be sure to observe the procedure “Powering off the projector” (➔ page 42) when performing power supply operation.

Maintenance

Outer Case

Wipe off dirt and dust using a soft dry cloth.

- If the dirt is persistent, soak the cloth with water and wring it thoroughly before wiping. Dry off the projector with a dry cloth.
- Do not use benzene, thinner or rubbing alcohol, other solvents or household cleaners. Using them may cause deterioration of the outer case.
- When using chemical treated dusters, follow its instruction.

Front glass surface of the lens

Wipe off the dirt and dust off the front surface of the lens with soft clean cloth.

- Do not use a cloth that has an abrasive surface or a cloth that is moist, oily or covered with dust.
- Do not use excessive force when wiping the lens as it is easily scratched.
- Do not use benzene, thinner or rubbing alcohol, other solvents or household cleaners. Using them may cause deterioration of the lens.

Attention

- The lens may be damaged if you hit with a hard object or wipe with excessive force. Please handle with care.

Replacing the unit

Air filter unit

The air filter prevents dust from accumulating on the optical elements inside the projector. Should the air filter become clogged with dust particles, it will reduce cooling fans' effectiveness and may result in internal heat buildup and adversely affect the life of the projector.

Also, if the internal temperature of the unit becomes high, the power of the projector may be turned off to protect internal components.

If a warning message appears on the screen, replace the air filter immediately.

Consult your dealer to purchase a replacement air filter unit (ET-RFV300).

Removing the air filter unit

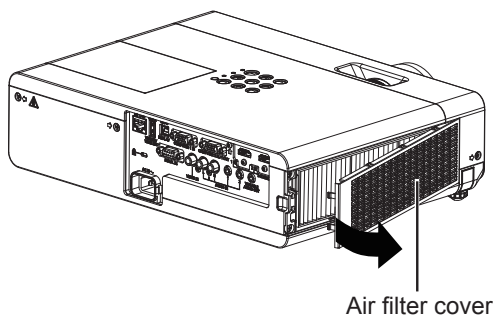

Fig.1

Air filter cover

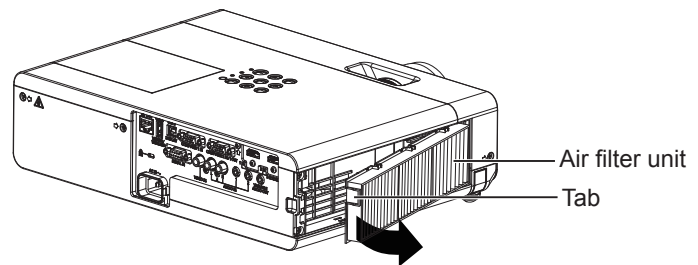

Fig.2

Air filter unit
Tab

1) Remove the air filter cover. (Fig.1)

- Open the air filter cover in the direction of the arrow and remove it.

2) Remove the air filter unit.

- Hold the tab of the air filter unit and pull out in the direction of the arrow. (Fig.2)
- After removing the air filter unit, remove foreign objects and dust from the air filter compartment and the projector's air intake port if there are any.

Attaching the air filter unit

1) Attach the unused air filter unit to the projector.

- Hold the air filter unit that the tab is in up-left side in the figure, put the right side in the figure first, and press the tab side until make a click sound.
- Please press the tab of the air filter unit other than the pleated filter during installation.

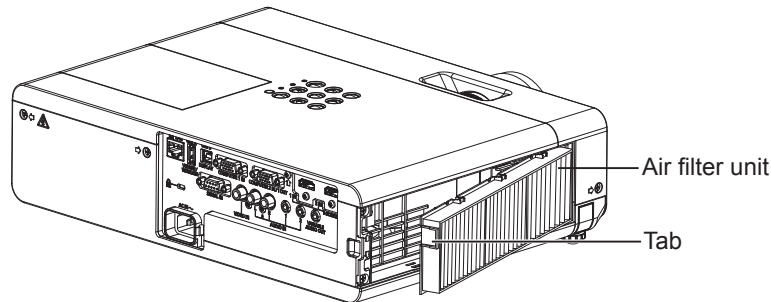

2) Install the air filter cover.

- Perform Step 1) in “Removing the air filter unit” (➔ page 116) in the reverse order to close the air filter cover and press it firmly until make a click sound.
- Make sure that the air filter cover is closed tightly.

Resetting the filter counter

Be sure to reset the filter counter after replacing the air filter unit.

- 1) **Connect the power plug, press the power <⏻/▶> button.**
- 2) **Press the <MENU> button to display the main menu, then press ▲▼ to select [PROJECTOR SETUP].**
- 3) **Press the <ENTER> button, press ▲▼ to select [FILTER COUNTER].**
- 4) **Press the <ENTER> button, press ▲▼ to select [FILTER COUNTER RESET].**
- 5) **Press the <ENTER> button.**
 - [FILTER COUNTER RESET] confirmation is displayed.
- 6) **Press ◀▶ to select [OK], then press the <ENTER> button.**
 - The filter usage time is 0 after reset.

Attention

- Turn off the power before you replace the air filter unit.
- When attaching the air filter unit, make sure that the projector is stable, and work in an environment that is safe, even in the event of the air filter unit dropping.
- Make sure that the air filter unit is properly attached before using the projector. If it is not attached, the projector will suck in dirt and dust causing a malfunction.
- Do not put anything into the air vents. Doing so may result in malfunction of the projector.
- The air filter unit to be replaced should be an unused product.

Note

- The time until the air filter is clogged varies greatly depending on the usage environment.
- When the projector is used without resetting the filter counter, the actual filter usage time (counter numeric value) will not be able to be confirmed.

Lamp unit

The lamp unit is a consumable component. Refer to “When to replace the lamp unit” (➔ page 118) for details about the replacement cycle.

It is recommended to ask an authorized engineer to replace the lamp unit. Contact your dealer. Consult your dealer to purchase a replacement lamp unit (ET-LAV300).

Warning

Do not replace the lamp unit when it is hot. (Wait at least 1 hour after use.)
The inside of the cover can become very hot, take care to avoid burn injuries.

Notes on the replacement of the lamp unit

- The luminous source of the lamp is made of glass and may burst if you hit it against a hard surface or drop it. Please handle with care.
- A Phillips screwdriver is required for replacement of the lamp unit.
- When replacing the lamp unit, be sure to hold it by the handle.
- When replacing the lamp because it has stopped illuminating, there is a possibility that the lamp may be broken. If replacing the lamp of a projector which has been installed on the ceiling, you should always assume that the lamp is broken, and you should stand to the side of the lamp cover, not underneath it. Remove the lamp cover gently. Small pieces of glass may fall out when the lamp cover is opened. If pieces of glass get into your eyes or mouth, seek medical advice immediately.
- The luminous lamp may be ruptured. Care should be taken not to scatter pieces of the broken luminous lamp glass when replacing the lamp unit. Pieces of the broken luminous lamp may fall from the lamp unit especially when the projector is mounted on the ceiling, so when replacing the lamp unit do not stand directly underneath it or position your face close to it.
- The luminous lamp contains mercury. Consult your local municipality or your dealer about correct disposal of used lamp units.

Attention

- Panasonic takes no responsibility for any damage or malfunction of the product resulting from use of lamp units which are not manufactured by Panasonic. Use only specified lamp units.



Note

- The model numbers of accessories and optional accessories are subject to change without prior notice.

When to replace the lamp unit

The lamp unit is a consumable component. Since its brightness gradually decreases over time, it is necessary to replace the lamp unit regularly. The estimated duration before replacement is 5 000 hours, but the luminous lamp may go off before 5 000 hours has elapsed depending on individual lamp unit characteristics, usage conditions, and the installation environment. It is recommended that the replacement lamp unit be prepared earlier.

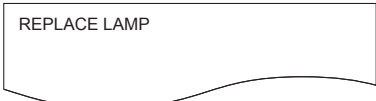
If you continue to use the lamp unit after 5 000 hours has elapsed, the lamp turns off automatically after approximately 10 minutes, as it will cause malfunction of the projector.

Lamp runtime	On-screen display 	Lamp indicator <LAMP> 
Over 4 800 hours	The message is displayed for 30 seconds. If you press any button within the 30 seconds, the message disappears.	Lights in red (even in stand-by mode).
Over 5 000 hours	If the power is turned on without replacing the lamp, the power automatically turns off after approximately ten minutes to prevent the malfunction of the projector.	

Note

- To predict when to replace the lamp, check the total runtime of the luminous lamp displayed in [TOTAL] in [STATUS] (▶ page 74).
- The 5 000 hours of use is a rough guideline, but is not a guarantee. The lamp runtime differs depending on the setting of "LAMP POWER" menu.

Replacing the lamp unit

Attention

- When the projector is mounted on a ceiling, do not work with your face close to the projector.
- Do not loosen other than designated screws.
- Attach the lamp unit and the lamp cover securely.

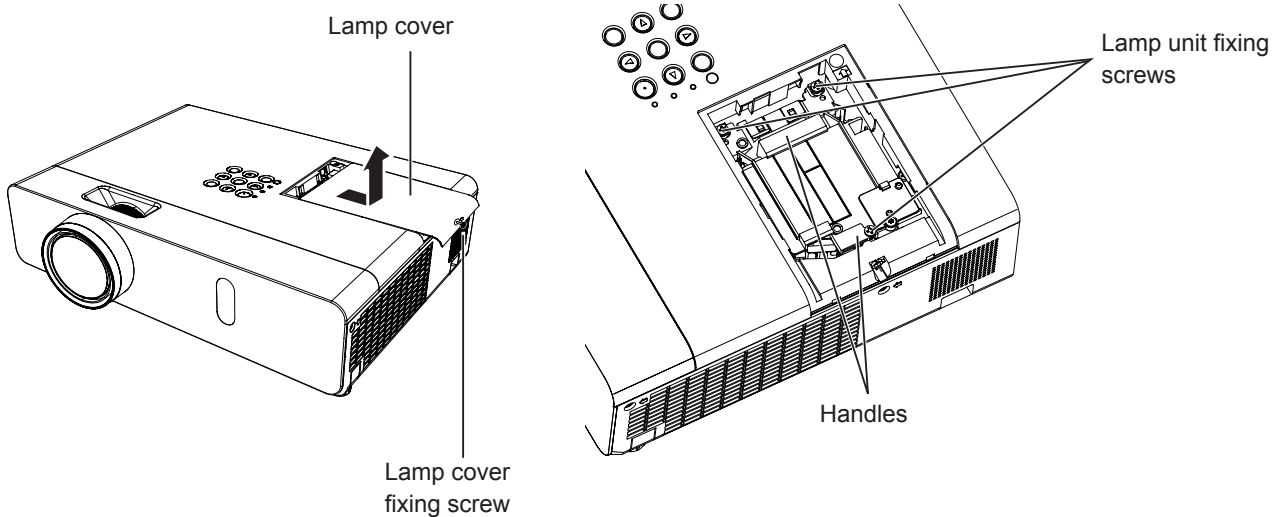

- 1) **Turn off the power by following the procedure in “Powering off the projector”. (➔ page 42)**
Remove the AC power plug from the wall outlet.
 - Wait at least 1 hour and make sure the lamp unit and surroundings are cool.
- 2) **Use a Phillips screwdriver to loosen the lamp cover fixing screw (×1) until it turns freely and remove the lamp cover.**
 - Remove the lamp cover by pulling it slowly toward the direction of the arrow.
- 3) **Use a Phillips screwdriver to loosen the three lamp unit fixing screws (×3) until they turn freely.**
- 4) **Hold the used lamp unit by its handles, and pull it gently from the projector.**
- 5) **Insert the new lamp unit in correct direction. Tighten the three lamp unit fixing screws (×3) securely with a Phillips screwdriver.**
 - When you experience difficulty in installing the lamp unit, remove it and try again. If you use force to install the lamp unit, the connector may be damaged.
- 6) **Attach the lamp cover. Tighten the lamp cover fixing screw (×1) securely with a Phillips screwdriver.**
 - Perform Step 2) in the reverse order to attach the lamp cover.

Note

- When you replace the lamp unit with a new one, the projector resets the runtime of the lamp unit automatically.

Troubleshooting

Please check following points. For details, see the corresponding pages.

Problem	Cause	Reference page
Power does not turn on.	• The power cord may not be connected.	—
	• No electric supply is at the wall outlet.	—
No picture appears.	• The circuit breakers have tripped.	—
	• Is the lamp indicator <LAMP> or the warning indicator <WARNING> lit or blinking?	115
	• The lamp cover has not been securely installed.	118
	• The video signal input source may not be connected to a terminal properly.	35
	• The video input selection setting may not be correct.	43
The picture is fuzzy.	• The [BRIGHTNESS] adjustment setting may be at the minimum setting.	56
	• The input source which is connected to the projector may have a problem.	—
	• The AV MUTE function may be in use.	46, 73
	• The lens cap is still attached to the lens.	21
	• The lens focus may not have been set correctly.	44
The color is pale or grayish.	• The projector may not be at the correct distance from the screen.	32
	• The lens may be dirty.	20
	• The projector may be tilted too much.	—
	• [COLOR] or [TINT] adjustment may be incorrect.	56, 57
No sound from the internal speaker.	• The input source which is connected to the projector may not be adjusted correctly.	—
	• The computer cable is damaged.	—
	• The input terminals may not have been correctly connected.	35
	• The volume may have been set to the minimum level.	46, 79
	• The AV MUTE function may have been turned on.	46, 73
	• When the VARIABLE AUDIO OUT is plugged-in, the projector's built-in speaker is not available.	35
The remote control does not operate.	• The MUTE function may have been turned on.	46, 79
	• Is the audio input selection in [AUDIO SETTING] set correctly?	79
	• The batteries may be weak.	—
	• The batteries may not have been inserted correctly.	27
	• The remote control signal receptor on the projector may be obstructed.	24
	• The remote control unit may be out of the operation range.	24
	• Strong light such as fluorescent shines onto the signal receptor.	24
• The [REMOTE CONTROLLER] setting is set to [DISABLE] in [CONTROL DEVICE SETUP].	83	
The control buttons of the projector do not operate.	• Is the ID number setting operation correct?	49
	• The [CONTROL PANEL] setting is set to [DISABLE] in [CONTROL DEVICE SETUP].	83
The picture does not display correctly.	• The [TV-SYSTEM], [RGB/YC _B C _R]/[RGB/YP _B P _R] selection set correctly?	59
	• There may be a problem with the VCR or other signal source.	—
	• A signal which is not compatible with the projector is being input.	128
Picture from a computer does not appear.	• Is the cable too long? (For D-Sub cables, the cable length should be 10 m (32'10") or shorter.)	—
	• Is the external video output on the laptop computer set correctly? (Ex.: The external output settings may be switched by pressing the "Fn" + "F3" or "Fn" + "F10" simultaneously. Since the method varies depending on the computer type, refer to the user manual provided with your computer.)	—
Picture from a HDMI device does not appear or picture is not stable.	• Is the HDMI cable securely connected?	35, 36
	• Turn off the power of the projector and the connected devices. Then turn the power of the projector and the connected devices back on.	—
	• Isn't unsupported signal cable connected?	128
No sound is output from a HDMI device.	• Set the sound channel of the attached device to Linear PCM.	—

Attention

- If the problem persists, after confirming the contents of the table, please consult your dealer.

Chapter 7 Appendix

This chapter describes specifications and after-sales service for the projector.

Technical Information

PJLink protocol

The network function of the projector supports PJLink class 1, and the PJLink protocol can be used to perform projector setting and projector status query operations from a computer.

Control commands

The following table lists the PJLink protocol commands that can be used to control the projector.

- x characters in tables are non-specific characters.

Command	Control details	Parameter / return string	Remark		
POWR	Power supply control	0 1	Standby Power on		
POWR ?	Power supply status query	0 1 2 3	Standby Power on Cool-down in progress Warm-up in progress		
INPT	Input selection	11 12 21 31	COMPUTER1 COMPUTER2 VIDEO HDMI1		
INPT ?	Input selection query	32 41 51 52	HDMI2 MEMORY VIEWER NETWORK USB DISPLAY		
AVMT	AV MUTE control *1	30	AV mute function disabled (off)		
AVMT ?	AV MUTE status query	31	AV mute function enabled (on)		
ERST ?	Error status query	xxxxxx	1st byte	Indicates fan errors, and returns 0 or 2	<ul style="list-style-type: none"> • 0 = No error known • 1 = Warning • 2 = Error
			2nd byte	Indicates luminous lamp errors, and returns 0 – 2	
			3rd byte	Indicates temperature errors, and returns 0 – 2	
			4th byte	Indicates cover open errors, and returns 0 or 2	
			5th byte	Indicates filter errors, and returns 0 – 2	
			6th byte	Indicates other errors, and returns 0 or 2	
LAMP ?	Luminous lamp status query	xxxxxx	1st number (1 – 5 digits) : Total usage time of luminous lamp 2nd number : 0 = Luminous lamp off, 1 = Luminous lamp on		
INST ?	Input selection list query	11 12 21 31 32 41 51 52			
NAME ?	Projector name query	xxxxx	Returns the projector name set in [NAME CHANGE] of [NETWORK/USB].		
INF1 ?	Manufacturer name query	Panasonic	Returns manufacturer name.		
INF2 ?	Model name query	VW360 VX430	Returns model name.		
INF0 ?	Other information query	xxxxx	Returns information such as version number.		
CLSS ?	Class information query	1	Returns class for PJLink.		

*1 When the [PROJECTOR SETUP] menu → [ECO MANAGEMENT] → [AV MUTE DETECTION] is set to [ON], do not switch on/off in a short time.

PJLink security authentication

The password used for PJLink is the same as that of the password set for web control.

When using the projector without security authentication, do not set a password for web control.

- For specifications related to PJLink, refer to the website of Japan Business Machine and Information System Industries Association.
URL <http://pjlink.jbmia.or.jp/english/>

Control commands via LAN

You can also control via the <LAN> terminal by using the control command format via the <SERIAL IN> terminal. For examples of the available commands, refer to “Control commands” (➔ page 127).

When web control administrator rights password is set (Protect mode)

Connection method

1) Obtain the IP address and port number (Initial set value = 1 024) of the projector and make a request for connection to the projector.

- Acquire the IP address from the menu screen of the projector, and the port number from the web control page.

IP address	Obtain from the [NETWORK/USB] menu → [STATUS]
Port No.	Obtain from [Detailed set up] → [Port set up] page of the web control

2) Check the response from the projector.

	Data section	Blank	Mode	Blank	Random number section	Termination symbol
Command example	"NTCONTROL" (ASCII string)	' '	'1'	' '	"zzzzzzzz" (ASCII code hexadecimal number)	(CR) 0x0d
Data length	9 bytes	1 byte	1 byte	1 byte	8 bytes	1 byte

- Mode : 1 = Protect mode

3) Generate a 32-byte hash value from the following data using MD5 algorithm.

- "xxxxxx:yyyyy:zzzzzzzz"

xxxxxx :	Administrator rights user name for web control (Default user name is "dispadmin")
yyyyy :	Password of above administrator rights user (Default password is "@Panasonic")
zzzzzzzz :	8-byte random number obtained in Step 2)

Command data format

It is the data format used for sending and receiving commands.

■ Transmitted data

	Header			Data section	Termination symbol
Command example	Hash value (See above "Connection method")	'0'	'0'	Control command (ASCII string)	(CR) 0x0d
Data length	32 bytes	1 byte	1 byte	Undefined length	1 byte

■ Received data

	Header		Data section	Termination symbol
Command example	'0'	'0'	Control command (ASCII string)	(CR) 0x0d
Data length	1 byte	1 byte	Undefined length	1 byte

■ Error response

	String	Details	Termination symbol
Message	"ERR1"	Undefined control command	(CR) 0x0d
	"ERR2"	Out of parameter range	
	"ERR3"	Busy state or no-acceptable period	
	"ERR4"	Timeout or no-acceptable period	
	"ERR5"	Wrong data length	
	"ERRA"	Password mismatch	
Data length	4 bytes	—	1 byte

When web control administrator rights password is not set (Non-protect mode)

Connection method

- 1) Obtain the IP address and port number (Initial set value = 1 024) of the projector and make a request for connection to the projector.

- Acquire the IP address from the menu screen of the projector, and the port number from the web control page.

IP address	Obtain from main menu → [NETWORK/USB] → [STATUS]
Port No.	Acquire from the web control → [Detailed set up] → [Port set up] page

- 2) There is a response from the projector.

■ Response data

	Data section	Blank	Mode	Termination symbol
Command example	"NTCONTROL" (ASCII string)	' '	'0'	(CR)
Data length	9 bytes	1 byte	1 byte	1 byte

- Mode : 0 = Non-protect mode

Command data format

It is the data format used for sending and receiving commands.

■ Transmitted data

	Header		Data section	Termination symbol
Command example	'0'	'0'	Control command (ASCII string)	(CR)
Data length	1 byte	1 byte	Undefined length	1 byte

■ Received data

	Header		Data section	Termination symbol
Command example	'0'	'0'	Control command (ASCII string)	(CR)
Data length	1 byte	1 byte	Undefined length	1 byte

■ Response data

	String	Details	Termination symbol
Message	"ERR1"	Undefined control command	(CR) 0x0d
	"ERR2"	Out of parameter range	
	"ERR3"	Busy state or no-acceptable period	
	"ERR4"	Timeout or no-acceptable period	
	"ERR5"	Wrong data length	
	"ERRA"	Password mismatch	
Data length	4 bytes	—	1 byte

<SERIAL IN> terminal

The <SERIAL IN> terminal of the projector conforms to RS-232C so that the projector can be connected to and controlled from a computer.

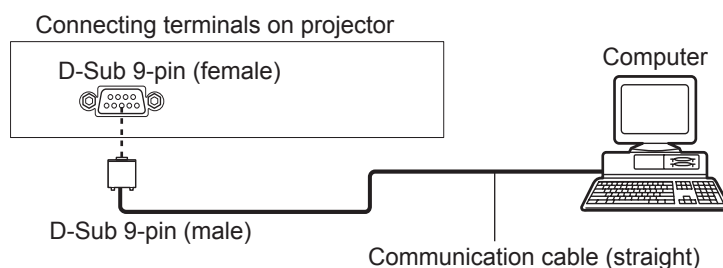
Connection**Pin assignments and signal names**

D-Sub 9-pin (female) Outside view	Pin No.	Signal name	Contents
		①	—
②		TXD	Transmitted data
③		RXD	Received data
④		—	NC
⑤		GND	Earth
⑥		—	NC
⑦		CTS	Connected internally
⑧		RTS	
⑨		—	NC

Communication conditions

The communication conditions differ depending on the setting of [PROJECTOR SETUP] menu → [EMULATE]. When [EMULATE] is set to [DEFAULT], the communication conditions are as follows.

Signal level	RS-232C-compliant
Sync. method	Asynchronous
Baud rate	9 600 bps
Parity	None
Character length	8 bits
Stop bit	1 bit
X parameter	None
S parameter	None

Basic format

Transmission from the computer starts with STX, then the ID, command, parameter, and ETX are sent in this order. Add parameters according to the details of control.

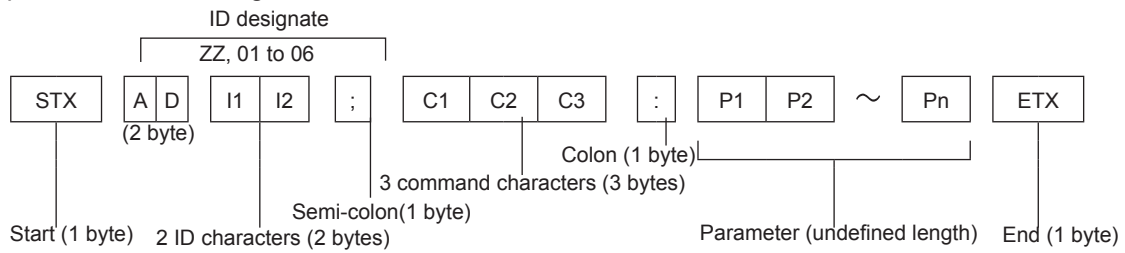

Basic format (with sub command)

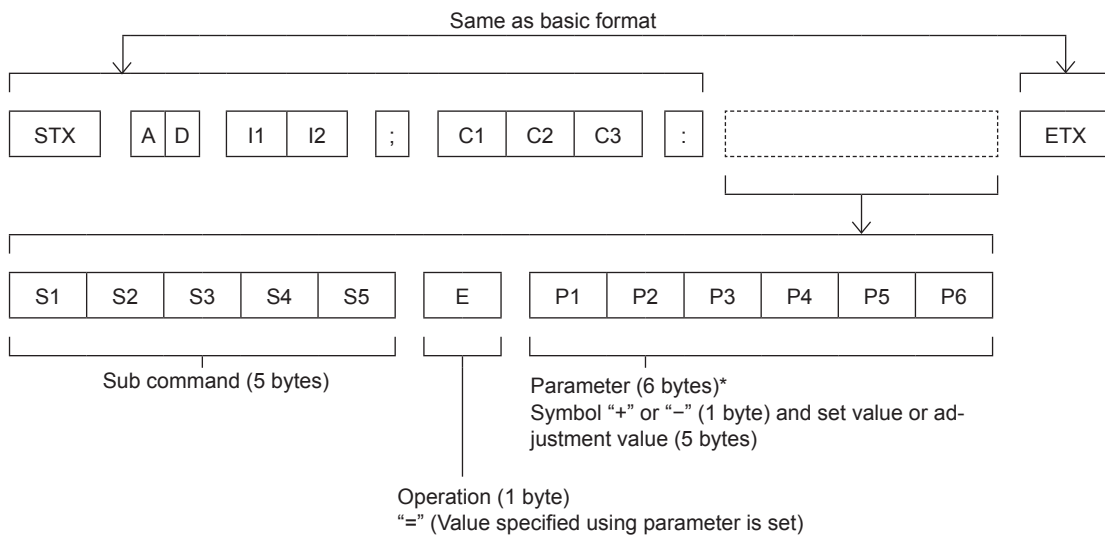

* When transmitting a command which does not need a parameter, the operation (E) and parameter are not necessary.

Attention

- If a command is transmitted after the luminous lamp starts illuminating, there may be a delay in response or the command may not be executed. Try sending or receiving any command after 60 seconds.
- When transmitting multiple commands, be sure to wait until 0.5 seconds has elapsed after receiving the response from the projector before sending the next command. When transmitting a command which does not need a parameter, a colon (:) is not necessary.

Note

- If a command cannot be executed, the "ER401" response is sent from the projector to the computer.
- If an invalid parameter is sent, the "ER402" response is sent from the projector to the computer.
- ID transmission in RS-232C supports ZZ (ALL) and 01 to 06.
- If a command is sent with a specified ID, a response will be sent to the computer only in the following cases.
 - It matches the projector ID.
 - [PROJECTOR ID] (► page 75) is set to [ALL].
- STX and ETX are character codes. STX shown in hexadecimal is 02, and ETX shown in hexadecimal is 03.

Cable specifications

[When connected to a computer]

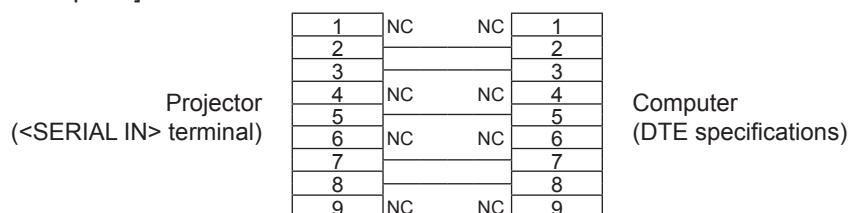

Control commands

When controlling the projector from a computer, the following commands are available.

■ Projector control command

Command	Control Details	Parameter/response string	Remark (parameter)
PON	Power on	—	To check if the power is on, use the "Power query" command.
POF	Power standby		
QPW	Power query	000 001	STANDBY Power on
IIS	Switching the input signal	VID RG1 RG2 HD1 HD2 NWP UD1 MV1	VIDEO COMPUTER1 COMPUTER2 HDMI1 HDMI2 NETWORK USB DISPLAY MEMORY VIEWER
AUU	Volume up	—	—
AUD	Volume down		
Q\$L	Luminous lamp cumulative runtime query	1	Returned with 0 to 99999
OSH	AV mute control	0	AV mute function off
QSH	AV mute status query	1	AV mute function on
Q\$\$	Luminous lamp condition query	0 1 2 3	Stand-by Luminous lamp ON control active Luminous lamp ON Luminous lamp OFF control active
VSE	Aspect ratio switch	0 1 2 5	AUTO NORMAL WIDE NATIVE
QS1	Aspect ratio settings query	6 9 10	FULL H FIT V FIT

■ Projector control command (with sub command)

Command	Sub command	Details	Remark
VXX	RYC11	COMPUTER1 input setting	+00000=RGB/YP _B P _R , +00001=Y/C

[MENU LOCK PASSWORD] operations

To initialize your password, consult your distributor.

List of compatible signals

The following table specifies the type of signals compatible with the projectors.

• Symbols that indicate formats are as follows.

- V: VIDEO, Y/C
- R: RGB
- Y: YC_BC_R/YP_BP_R
- H: HDMI

Mode	Display resolution (dots)	Scanning frequency		Dot clock frequency (MHz)	Format	PnP*1	
		H (kHz)	V (Hz)			COMPUTER1/ COMPUTER2	HDMI 1/2
NTSC/NTSC4.43/ PAL-M/PAL60	720 x 480i	15.7	59.9	—	V	—	—
PAL/PAL-N/SECAM	720 x 576i	15.6	50.0	—	V	—	—
525i (480i)	720 x 480i	15.7	59.9	13.5	R/Y	—	—
625i (576i)	720 x 576i	15.6	50.0	13.5	R/Y	—	—
525i (480i)	720 (1 440) x 480i ²	15.7	59.9	27.0	H	—	—
625i (576i)	720 (1 440) x 576i ²	15.6	50.0	27.0	H	—	—
525p (480p)	720 x 483	31.5	59.9	27.0	R/Y/H	—	✓
625p (576p)	720 x 576	31.3	50.0	27.0	R/Y/H	—	✓
750 (720) /60p	1 280 x 720	45.0	60.0	74.3	R/Y/H	—	✓
750 (720) /50p	1 280 x 720	37.5	50.0	74.3	R/Y/H	—	✓
1125 (1080) /60i ³	1 920 x 1 080i	33.8	60.0	74.3	R/Y/H	—	✓
1125 (1080) /50i	1 920 x 1 080i	28.1	50.0	74.3	R/Y/H	—	✓
1125 (1080) /24p	1 920 x 1 080	27.0	24.0	74.3	R/Y/H	—	✓
1125 (1080) /24sF	1 920 x 1 080i	27.0	48.0	74.3	R/Y/H	—	—
1125 (1080) /25p	1 920 x 1 080	28.1	25.0	74.3	R/Y/H	—	—
1125 (1080) /30p	1 920 x 1 080	33.8	30.0	74.3	R/Y/H	—	—
1125 (1080) /60p	1 920 x 1 080	67.5	60.0	148.5	R/Y/H	—	✓
1125 (1080) /50p	1 920 x 1 080	56.3	50.0	148.5	R/Y/H	—	✓
VESA400	640 x 400	31.5	70.1	25.2	R/H	—	—
	640 x 400	37.9	85.1	31.5	R/H	—	—
VGA	640 x 480	31.5	59.9	25.2	R/H	✓	✓
	640 x 480	35.0	66.7	30.2	R/H	—	—
	640 x 480	37.9	72.8	31.5	R/H	✓	✓
	640 x 480	37.5	75.0	31.5	R/H	✓	✓
	640 x 480	43.3	85.0	36.0	R/H	—	—
SVGA	800 x 600	35.2	56.3	36.0	R/H	✓	✓
	800 x 600	37.9	60.3	40.0	R/H	✓	✓
	800 x 600	48.1	72.2	50.0	R/H	✓	✓
	800 x 600	46.9	75.0	49.5	R/H	✓	✓
	800 x 600	53.7	85.1	56.3	R/H	—	—
MAC16	832 x 624	49.7	74.6	57.3	R/H	✓	✓
XGA	1 024 x 768	39.6	50.0	51.9	R/H	—	—
	1 024 x 768	65.5	81.6	86.0	R/H	—	—
	1 024 x 768	48.4	60.0	65.0	R/H	—	—
	1 024 x 768	56.5	70.1	75.0	R/H	✓	✓
	1 024 x 768	60.0	75.0	78.8	R/H	✓	✓
	1 024 x 768	81.4	100.0	113.3	R/H	—	—
	1 024 x 768	68.7	85.0	94.5	R/H	—	—
MXGA	1 152 x 864	53.7	60.0	81.6	R/H	—	—
	1 152 x 864	67.5	75.0	108.0	R/H	—	—
	1 152 x 864	77.1	85.0	119.7	R/H	—	—
MAC21	1 152 x 870	68.7	75.1	100.0	R/H	✓	✓
1280 x 720	1 280 x 720	37.1	50.0	60.5	R/H	—	—
	1 280 x 720	44.8	60.0	74.5	R/H	—	—

Chapter 7 Appendix - Technical Information

Mode	Display resolution (dots)	Scanning frequency		Dot clock frequency (MHz)	Format	PnP*1	
		H (kHz)	V (Hz)			COMPUTER1/ COMPUTER2	HDMI 1/2
1280 x 768	1 280 x 768	60.3	74.9	102.3	R/H	—	—
	1 280 x 768	68.6	84.8	117.5	R/H	—	—
1280 x 800	1 280 x 800	62.8	74.9	106.5	R/H	—	—
	1 280 x 800	71.6	84.9	122.5	R/H	—	—
	1 280 x 800	41.3	50.0	68.0	R/H	—	—
	1 280 x 800	49.7	59.8	83.5	R/H	✓ ^{*5}	✓ ^{*5}
1280 x 960	1 280 x 960	60.0	60.0	108.0	R/H	—	—
SXGA	1 280 x 1 024	64.0	60.0	108.0	R/H	—	—
	1 280 x 1 024	80.0	75.0	135.0	R/H	—	—
	1 280 x 1 024	91.1	85.0	157.5	R/H	—	—
1366 x 768	1 366 x 768	39.6	49.9	69.0	R/H	—	—
	1 366 x 768	47.7	59.8	85.5	R/H	—	—
SXGA+	1 400 x 1 050	65.3	60.0	121.8	R/H	—	—
	1 400 x 1 050	65.2	60.0	122.6	R/H	—	—
	1 400 x 1 050	82.3	74.9	156.0	R/H	—	—
1440 x 900	1 440 x 900	55.9	59.9	106.5	R/H	—	—
1600 x 900	1 600 x 900	46.3	50.0	97.0	R/H	—	—
	1 600 x 900	55.9	60.0	119.0	R/H	—	—
UXGA	1 600 x 1 200	75.0	60.0	162.0	R/H	✓	✓
1680 x 1050	1 680 x 1 050	54.1	50.0	119.5	R/H	—	—
	1 680 x 1 050	65.3	60.0	146.3	R/H	—	—
1920 x 1080	1 920 x 1 080	55.6	49.9	141.5	R/H	—	—
	1 920 x 1 080 ^{*4}	66.6	59.9	138.5	R/H	—	—
WUXGA	1 920 x 1 200	61.8	49.9	158.3	R/H	—	—
	1 920 x 1 200 ^{*4}	74.0	60.0	154.0	R/H	—	—

*1 Where marked “✓” signals indicates in Plug and Play is compatible with EDID of projector. Unmarked signals in Plug and Play may also be compliant if input terminals are written in the format list. Where Plug and Play is unmarked and nothing is written in the format list, difficulties in projecting image may occur even when computer and projector appear to have same resolution.

*2 Pixel-Repetition signal (dot clock frequency 27.0 MHz) only

*3 When a 1125 (1035)/60i signal was input, it is displayed as a 1125 (1080)/60i signal.

*4 VESA CVT-RB (Reduced Blanking)-compliant.

*5 Only for PT-VW360

Note

- The number of display dots is 1 280 x 800 for the PT-VW360 and 1 024 x 768 for the PT-VX430.
A signal with a different resolution will be projected after converting the resolution to match the projector display.
- “i” added to the resolution value indicates an interlaced signal.
- When interlaced signals are connected, flicker may occur on the projected image.

Specifications

The specifications of this projector are as follows.

Power supply		For North America: 120 V ~ (120 V alternating current), 50 Hz/60 Hz For other countries: 100 V - 240 V ~ (100 V - 240 V alternating current), 50 Hz/60 Hz	
Power consumption	Projecting	For North America: 3.2 A, 320 W For other countries: 3.7 A-1.5 A, 320 W	
	In standby mode	When [STANDBY MODE] of [ECO MANAGEMENT] is set to [ECO] : 0.5 W When [STANDBY MODE] of [ECO MANAGEMENT] is set to [NETWORK] : 1 W When [STANDBY MODE] of [ECO MANAGEMENT] is set to [NORMAL] : 8 W When [STANDBY MODE] of [ECO MANAGEMENT] is set to [NORMAL], and [IN STANDBY MODE] of [AUDIO SETTING] is set to [ON] : 24 W	
LCD panel	Panel size	PT-VW360	1.5 cm (0.59") (aspect ratio 16 : 10)
		PT-VX430	1.6 cm (0.63") (aspect ratio 4 : 3)
	Display method	Translucent screen LCD panel 3 panels, 3 primary color system	
	Drive method	Active matrix method	
	Pixels	PT-VW360	1 024 000 (1 280 x 800) x 3 panels
PT-VX430		786 432 (1 024 x 768) x 3 panels	
Lens		Manual zoom : 1.6x Manual focus : F 1.6 to 1.9, f 15.31 mm to 24.64 mm	
Luminous lamp		240 W UHM lamp	
Light output *1	PT-VW360	4 000 lm	
	PT-VX430	4 500 lm	
	(When [PICTURE MODE] is set to [DYNAMIC], [LAMP POWER] is set to [NORMAL], [IRIS] is set to [OFF], [DAYLIGHT VIEW] is set to [OFF], and [AUTO POWER SAVE] is set to [OFF])		
Center to corner zone ratio *1		85%	
Contrast ratio *1		20 000 : 1 (When [PICTURE MODE] is set to [DYNAMIC], [LAMP POWER] is set to [NORMAL], [IRIS] is set to [ON], [DAYLIGHT VIEW] is set to [OFF], and [AUTO POWER SAVE] is set to [OFF])	
Color system		7 (NTSC, NTSC4.43, PAL, PAL-N, PAL-M, SECAM, PAL60)	
Projection size		0.76 m -7.62 m (30"-300")	
Screen aspect ratio	PT-VW360	16 : 10	
	PT-VX430	4 : 3	
Projection scheme		[FRONT/DESK], [FRONT/CEILING], [REAR/DESK], [REAR/CEILING]	
Speaker		1 (4.0 cm round-type)	
Maximum usable volume output		10 W	
Power cable length		2.0 m (78-3/4")	
Outer case		Molded plastic	
Outer color		White	
Dimensions		Width: 352 mm (13-27/32") Height: 98 mm (3-27/32") (when the adjustable feet shortened) Depth: 279 mm (10-31/32")	
Weight		Approx. 3.3 kg (7.28 lbs.) *2	
Noise level *1		When set to [NORMAL] in [LAMP POWER] : 37 dB When set to [ECO] in [LAMP POWER] : 29 dB	

Operating environment		Operating environment temperature *3: 0 °C (32 °F) to 40 °C (104 °F) (Elevation: below 1 400 m (4 593'); [HIGH ALTITUDE MODE]: [OFF]) 0 °C (32 °F) to 30 °C (86 °F) (Elevation: 1 400 m (4 593') ~ 2 000 m (6 562'); [HIGH ALTITUDE MODE]: [HIGH1]) 0 °C (32 °F) to 30 °C (86 °F) (Elevation: 2 000 m (6 562') ~ 2 700 m (8 858'); [HIGH ALTITUDE MODE]: [HIGH2]) Operating environment humidity: 20% to 80% (no condensation)
Remote control	Power supply	DC 3 V (battery (AAA/R03 or AAA/LR03 Type) x 2)
	Operating range	Approx. 7 m (22'11-5/8") (when operated directly in front of receptor)
	Weight	63 g (2.22 ozs.) (including batteries)
	Dimensions	Width : 44 mm (1-23/32"), Length : 105 mm (4-1/8"), Height : 20.5 mm (13/16")

*1 Measurement, measuring conditions and method of notation all comply with ISO/IEC 21118:2012 international standards.

*2 This is an average value. It may differ depending on individual product.

*3 If the [PROJECTOR SETUP] menu → [LAMP POWER] is set to [NORMAL], [LAMP POWER] will be switched to [ECO] forcibly to protect the projector when the operating environment temperature becomes 35 °C (95 °F) or higher.

Note

- The part numbers of accessories and separately sold components are subject to change without notice.

Terminal

<COMPUTER 1 IN> terminal	1 set high-density D-Sub 15 p (female) RGB signal 0.7 V [p-p] 75 Ω (When G-SYNC: 1.0 V [p-p] 75 Ω) SYNC/HD TTL high impedance, automatic positive/negative polarity compatible VD TTL high impedance, automatic positive/negative polarity compatible (The SYNC/HD and VD terminals do not support 3 value SYNC.) Y_BP_R signal Y: 1.0 V [p-p] including synchronization signal, P _B P _R : 0.7 V [p-p] 75 Ω Y/C signal Y: 1.0 V [p-p], C: 0.286 V [p-p] 75 Ω
<COMPUTER 2 IN /1 OUT> terminal	1 set, high-density D-Sub 15 p (female) RGB signal 0.7 V [p-p] 75 Ω (When G-SYNC: 1.0 V [p-p] 75 Ω) SYNC/HD TTL high impedance, automatic positive/negative polarity compatible VD TTL high impedance, automatic positive/negative polarity compatible (The SYNC/HD and VD terminals do not support 3 value SYNC.) Y_BP_R signal Y: 1.0 V [p-p] including synchronization signal, P _B P _R : 0.7 V [p-p] 75 Ω
<VIDEO IN> terminal	1 set, pin jack 1.0 V [p-p] 75 Ω
<HDMI 1 IN>/<HDMI 2 IN> terminal	2 sets, HDMI 19 pin, HDCP compatible, Deep Color compatible Audio signal Linear PCM (Sampling frequency: 48 kHz/44.1 kHz/32 kHz)
<AUDIO IN 1>/<AUDIO IN 2> terminal	2 sets, M3 stereo mini jack 0.5 V [rms], input impedance 22 kΩ or more
<AUDIO IN 3> terminal	1 set, pin jack x 2 (L-R) 0.5 V [rms], input impedance 22 kΩ or more
<VARIABLE AUDIO OUT> terminal	1 set, M3 stereo mini jack (monitor output, stereo compatible) 0 V [rms] to 2.0 V [rms] (variable), output impedance 2.2 kΩ or less
<USB A (VIEWER/WIRELESS)> terminal	1 set, USB connector (type A) Memory Viewer / Wireless module (Model No.: ET-WML100) compatible
<USB B (DISPLAY)> terminal	1 set, USB connector (type B), only for USB display function
<SERIAL IN> terminal	1 set, D-Sub 9 p, RS-232C compliant, for computer control
<LAN> terminal	1 set, RJ-45, for network connection, PLink (Class 1) compatible, 10Base-T/100Base-TX

■ **Wireless LAN**

To use the wireless LAN function with the projector, it is necessary to attach the optional Wireless Module (Model No.: ET-WML100).

Compliance standards	IEEE802.11b/g/n	
Transmission method	DSSS, OFDM	
Frequency range (Channel)	2 412 MHz to 2 462 MHz (1 to 11 ch)	
Transmission speed (Standard value)	IEEE802.11b	Maximum 11 Mbps
	IEEE802.11g	Maximum 54 Mbps
	IEEE802.11n	Maximum 150 Mbps
Encryption method	WPA2-PSK(AES)	

■ **Compatible signals**

Refer to “List of compatible signals” (➔ page 128) for the types of video signals that can be used with the projector.

For video signal input	Horizontal : 15.73 kHz Vertical : 59.94 Hz Horizontal : 15.63 kHz Vertical : 50 Hz
For Y/C signal input	Horizontal : 15.73 kHz Vertical : 59.94 Hz Horizontal : 15.63 kHz Vertical : 50 Hz
For RGB signal input	<ul style="list-style-type: none"> • Displayable resolution: 640 x 400 to 1 920 x 1 200 • Dot clock frequency: 162 MHz or less
For YC_BC_R/YP_BP_R signal input	<ul style="list-style-type: none"> • Displayable resolution: 480i/576i to 1 920 x 1 080 • Dot clock frequency: 148.5 MHz or less
For HDMI signal input	<ul style="list-style-type: none"> • Displayable resolution for movie-based signals: 480i/576i*1 to 1 920 x 1 080 • Displayable resolution for still image signals: 640 x 400 to 1 920 x 1 200 (non-interlaced) • Dot clock frequency: 25 MHz - 162 MHz

*1 Pixel-Repetition signal (dot clock frequency 27.0 MHz) only

Dimensions

<Unit : mm (inch)>

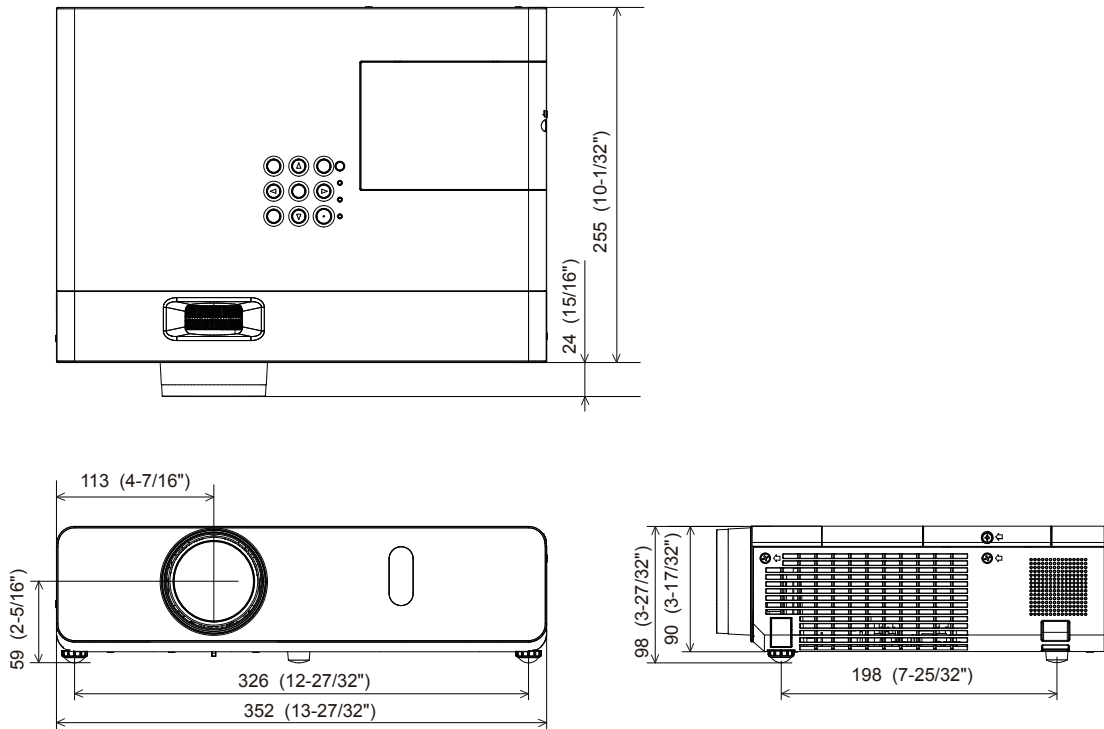

* Actual dimension may differ by product.

Ceiling mount bracket safeguards

- When installing the projector to a ceiling, be sure to use the specified optional Ceiling Mount Bracket for Projectors.
Model No. of ceiling mount bracket:
 - ① ET-PKL100H (for high ceilings), ET-PKV400B (Projector Mount Bracket)
 - ② ET-PKL100S (for low ceilings), ET-PKV400B (Projector Mount Bracket)
- When installing the projector, attach the drop-prevention kit included with the Ceiling Mount Bracket for Projectors.
- Ask a qualified technician to do the installation work such as mounting the projector on the ceiling.
- Panasonic takes no responsibility for any damage to the projector resulting from use of a ceiling mount bracket not manufactured by Panasonic or the inappropriate choice of location for installation, even if the warranty period of the projector has not expired.
- Unused products must be removed promptly by a qualified technician.
- Use a torque screwdriver or Allen torque wrench to tighten bolts to their specified tightening torques. Do not use electric screwdrivers or impact screwdrivers.
- Read the Installation Instructions for the Ceiling Mount Bracket for Projectors for details.
- The model numbers of accessories and optional accessories are subject to change without prior notice.

■ Specification for the screw holes to fix the projector (projector bottom view)

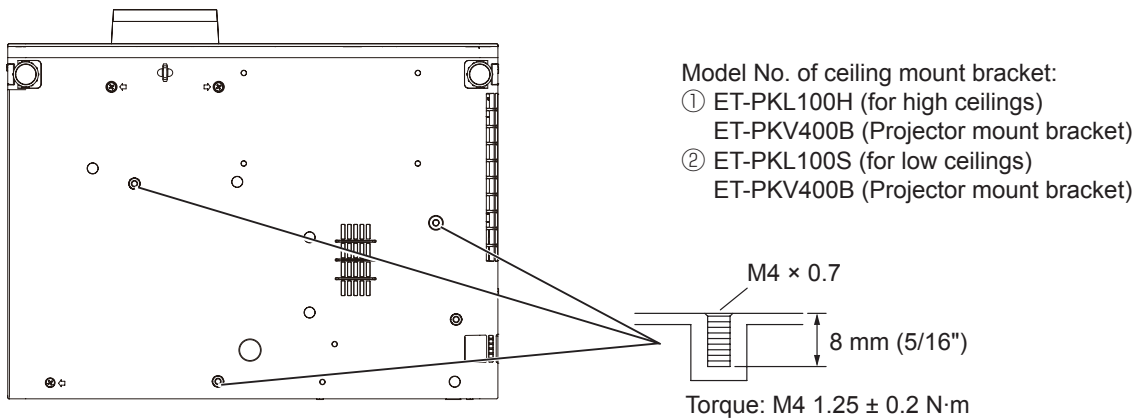

■ Dimensions for the screw holes to fix the projector (projector bottom view)

Unit: mm (inch)

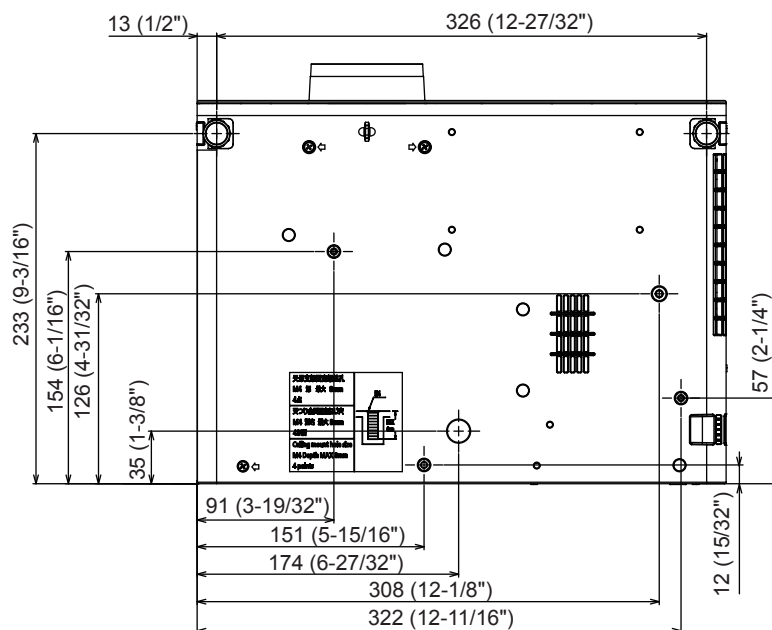

Index

- A**
- About Presenter Light..... 97
 - Accessories 21
 - <AC IN> terminal 24
 - Adjusting adjustable feet 45
 - [ADVANCED MENU] 58
 - [AMX D.D.] 86
 - [ASPECT] 65
 - Attaching the lens cap 28
 - <AUDIO IN 1> terminal / <AUDIO IN 2> terminal 26
 - <AUDIO IN 3 (L/R)> terminal 26
 - [AUDIO SETTING] 78
 - <AUTO SETUP> button
 - Projector body 25
 - Remote control 47
 - [AUTO SETUP SETTING] 71
 - <AV MUTE> button
 - Remote control 23, 46
- B**
- [BACK COLOR] 71
 - Basic operations by using the remote control 46
 - [BRIGHTNESS] 56
- C**
- Ceiling mount bracket safeguards .. 134
 - [CLOCK PHASE] 64
 - [CLOSED CAPTION SETTING] 69
 - [COLOR] 56
 - [COLOR TEMPERATURE] 57
 - <COMPUTER 1> button
 - Remote control 23
 - [COMPUTER1 INPUT SETTING] 74
 - <COMPUTER 1 IN> terminal 26
 - <COMPUTER 2> button
 - Remote control 23
 - <COMPUTER 2 IN/1 OUT> terminal 26
 - [COMPUTER2 SELECT] 74
 - Connecting 34
 - Connecting the power cord 38
 - [CONTRAST] 56
 - [CONTROL DEVICE SETUP] 83
 - [Crestron Connected (TM)] 86, 111
- D**
- [DAYLIGHT VIEW] 58
 - <DAYLIGHT VIEW> button
 - Remote control 23, 49
 - <DEFAULT> button
 - Remote control 23, 53
 - [DIGITAL CINEMA REALITY] 59
 - Dimensions 133
 - [DISPLAY OPTION] 68
 - Disposal 20
 - [DOT CLOCK] 64
 - <D.ZOOM+> button / <D.ZOOM-> button 23, 48
- E**
- Early Warning Software 19
 - [ECO MANAGEMENT] 76
 - [EMULATE] 78
 - <ENTER> button
 - Projector body 25
 - Remote control 23
- F**
- [FILTER COUNTER] 80
 - [FRAME LOCK] 66
- <FREEZE> button
 - Remote control 47
- <FUNCTION> button
 - Remote control 23, 49
- [FUNCTION BUTTON] 78
- H**
- <HDMI 1/2> button
 - Remote control 23
 - <HDMI 1 IN> terminal / <HDMI 2 IN> terminal 26
 - [HDMI SIGNAL LEVEL] 69
 - [HIGH ALTITUDE MODE] 75
- I**
- <ID ALL> button
 - Remote control 23, 49
 - <ID SET> button
 - Remote control 23, 49
 - [INITIALIZE] 88
 - [INITIALIZE ALL] 81
 - Initial setting 40
 - [INITIAL START UP] 75
 - <INPUT SELECT> button
 - Projector body 25, 43
 - Installation mode 30
 - [IRIS] 57
- K**
- [KEystone] 61
- L**
- Lamp indicator 25, 115
 - [LAMP POWER] 76
 - [LANGUAGE] 67
 - <LAN> terminal 26
 - List of compatible signals 128
- M**
- Main menu 53
 - Maintenance/replacement 116
 - Memory Viewer function 90
 - [MEMORY VIEWER LIGHT] 86
 - <MEMORY VIEWER/USB DISPLAY/ NETWORK> button
 - Remote control 23
 - <MENU> button
 - Projector body 25
 - [MENU LOCK] 83
 - [MENU LOCK PASSWORD] 83
 - Menu Navigation 52
 - <MUTE> button
 - Remote control 46
- N**
- [NAME CHANGE] 85
 - Network connection 94
 - [NETWORK CONTROL] 86
 - [NETWORK/USB] 85
 - [NOISE REDUCTION] 59
- O**
- [ON-SCREEN DISPLAY] 68
 - Optional accessories 22
 - [OTHER FUNCTIONS] 73
 - [OVER SCAN] 65
- P**
- [PASSWORD] 82
 - [PASSWORD CHANGE] 82
 - [PICTURE] 56
 - [PICTURE MODE] 56
 - PJLink protocol 122
- [POSITION] 61
- Power button
 - Projector body 25
 - Remote control 23
- Power indicator 25, 38
- Powering off the projector 42
- Powering on the projector 39
- Precautions for use 16
- Projecting 43
- [PROJECTION METHOD] 75
- [PROJECTOR ID] 75
- [PROJECTOR SETUP] 74
- [P-TIMER] 72
- <P-TIMER> button
 - Remote control 23, 48
- R**
- Read this first! 4
 - [REALTIME KEYSTONE] 61
 - Remote control 23
 - [RGB/Y_BP_R] / [RGB/YC_BC_R] 59
- S**
- <SCREEN ADJ> button
 - Remote control 23, 47
 - [SCREEN ADJUSTMENT] 61
 - [SCREEN SETTING] 70
 - Security 18
 - [SECURITY] 82
 - Selecting the input signal 43
 - <SERIAL IN> terminal 26
 - Setting up 30
 - [SHARPNESS] 57
 - [SHIFT] 63
 - [SIGNAL SEARCH] 71
 - Specifications 130
 - [STARTUP LOGO] 70
 - [STATUS] 74, 88
 - Storage 20
 - Sub-menu 54
 - [SXGA MODE] 71
- T**
- [TEST PATTERN] 80
 - [TEXT CHANGE] 83
 - [TEXT DISPLAY] 82
 - [TINT] 57
 - Troubleshooting 120
 - [TV-SYSTEM] 59
- U**
- <USB A (VIEWER/WIRELESS)> terminal 26
 - <USB B (DISPLAY)> terminal 26
 - USB Display function 92
- V**
- <VARIABLE AUDIO OUT> terminal 26
 - <VIDEO> button
 - Remote control 23, 43
 - <VIDEO IN> terminal 26
 - <VOL +> button / <VOL -> button
 - Remote control 23, 46
- W**
- Warning indicator 25, 115
 - [WIDE MODE] 71
 - [WIRED LAN] 85

Disposal of Old Equipment and Batteries

Only for European Union and countries with recycling systems



These symbols on the products, packaging, and/or accompanying documents mean that used electrical and electronic products and batteries must not be mixed with general household waste. For proper treatment, recovery and recycling of old products and used batteries, please take them to applicable collection points in accordance with your national legislation. By disposing of them correctly, you will help to save valuable resources and prevent any potential negative effects on human health and the environment.

For more information about collection and recycling, please contact your local municipality. Penalties may be applicable for incorrect disposal of this waste, in accordance with national legislation.



Note for the battery symbol (bottom symbol)

This symbol might be used in combination with a chemical symbol. In this case it complies with the requirement set by the Directive for the chemical involved.

Information on Disposal in other Countries outside the European Union

These symbols are only valid in the European Union.

If you wish to discard these items, please contact your local authorities or dealer and ask for the correct method of disposal.

Product information (for Turkey only)

AEEE Yönetmeliğine Uygundur.

Eski Ekipman ve Bataryaların İşlenmesi.

Sadece geri dönüşüm sistemleri olan Avrupa Birliği ve ülkeleri için geçerlidir.



Ürünler, ambalaj ve/veya ekli belgeler üzerindeki bu semboller kullanılmış elektrik ve elektronik ürünlerin ve pillerin genel ev atığı ile karıştırılmaması gerektiğini ifade eder.

Eski ürünlerin ve pillerin toplanması ve geri kazanılması için bu atıkları lütfen yasayla belirlenmiş olan uygun toplama merkezlerine teslim ediniz.

Bu atıkların doğru işlenmesiyle, değerli kaynakların korunmasına ve insan sağlığı ve çevreye olası negatif etkilerinin engellenmesine yardımcı olabilirsiniz.

Atıkların toplanması ve geri dönüşümü için detaylı bilgi için lütfen bağlı olduğunuz yerel yönetimlerle iletişime geçiniz.

Atıkların atılmasıyla ilgili yanlış uygulamalar yasayla belirlenmiş olan cezalara sebebiyet verebilir.

Panasonic Corporation

Web Site : <https://panasonic.net/cns/projector/>

© Panasonic Corporation 2018

Panasonic System Solutions Company of North America

Two Riverfront Plaza, Newark, NJ 07102

TEL: (877) 803 - 8492

Panasonic Canada Inc.

5770 Ambler Drive, Mississauga, Ontario L4W 2T3

TEL: (905) 624 - 5010

W0318NL1078 -PT