

Dolphin™ CT60

Mobile Computer
powered by Android™ 7

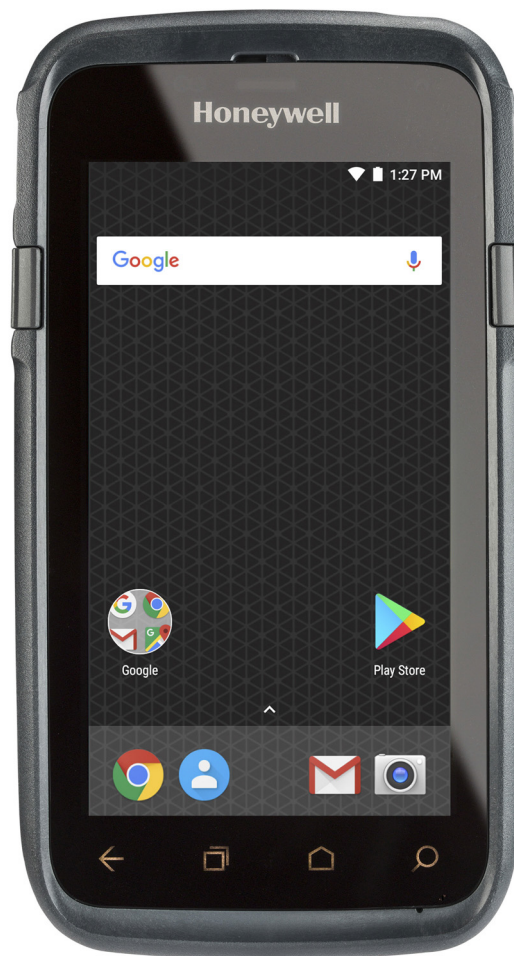

User Guide

Disclaimer

Honeywell International Inc. (“HII”) reserves the right to make changes in specifications and other information contained in this document without prior notice, and the reader should in all cases consult HII to determine whether any such changes have been made. The information in this publication does not represent a commitment on the part of HII.

HII shall not be liable for technical or editorial errors or omissions contained herein; nor for incidental or consequential damages resulting from the furnishing, performance, or use of this material. HII disclaims all responsibility for the selection and use of software and/or hardware to achieve intended results.

This document contains proprietary information that is protected by copyright. All rights are reserved. No part of this document may be photocopied, reproduced, or translated into another language without the prior written consent of HII.

Copyright © 2018 Honeywell International Inc. All rights reserved.

Web Address: www.honeywellaidc.com

Trademarks

Google, Google Play store, Google Pay and Android are trademarks of Google LLC.

Bluetooth trademarks are owned by Bluetooth SIG, Inc., U.S.A. and licensed to Honeywell.

microSD is a registered trademark of SD-3C, LLC.

Qualcomm and Snapdragon are registered trademarks or trademarks of Qualcomm Incorporated in the United States and/or other countries.

Other product names or marks mentioned in this document may be trademarks or registered trademarks of other companies and are the property of their respective owners.

Patents

For patent information, refer to www.hsmpats.com.

TABLE OF CONTENTS

Customer Support	ix
Technical Assistance	ix
Product Service and Repair	ix
Limited Warranty	ix

Chapter 1 - About the Computer Features..... 1

About the Dolphin CT60 Mobile Computer	1
Model Overview	1
Features of the CT60	2
About the Battery	4
Charge the Battery Before Use.....	4
Replace the Battery.....	4
About the Battery Status.....	6
Change the Battery Status LED Behavior.....	7
Check the Battery Level and Usage	8
About Battery Life and Conservation	8
Battery Recommendations and Safety Precautions	9
Enable Airplane Mode	9
Power On the Computer	10
Welcome Screen.....	10
Unlock the Screen	10
Change the Screen Lock to Protect the Computer	10
Select a Touch Screen Profile to Optimize Performance.....	11
Configure the Screen Backlight	12
About the Good Read LED.....	12

About the Audio Features	12
Adjust Speaker Volume	13
Enable Vibrate Mode.....	13
Audio Settings	14
Insert a microSD Card.....	15
How to Transfer Files.....	18
Configure USB Connection and Transfer Files	18
Accessories for the Computer.....	18

Chapter 2 - About the User Interface and Applications..... 21

About the User Interface.....	21
Navigation and Function Buttons	22
About Status Bar Icons	23
Remap a Button	23
Restore Default Button Action	24
View and Manage Notifications	24
Open Quick Settings	24
Customize the Home Screen	25
Customize the Favorites Tray	25
Use Google™ Search.....	25
About Screen Gestures	26
Set the Time Zone.....	26
About Honeywell Applications.....	27
Applications You Can Download to the Mobile Computer	28
About Honeywell Enterprise Browser	28
About Honeywell Launcher	28
About Enterprise Terminal Emulator.....	29
Unlock Developer Options	29

Chapter 3 - Use the Image Engine 31

About the Image Engine	31
About the Scan Wedge Feature	31
Change the Scanner Settings.....	32

Restore Default Scan Settings	32
Default Scan Settings	33
Data Processing Settings.....	33
Symbology Settings	34
Decode Settings	35
Imager Settings	36
Trigger Settings.....	36
Notification Settings.....	36
Add a Scan Setting Profile.....	37
Delete a Scan Setting Profile	37
About the Optional Digital Scan Button	37
Enable and Configure the Digital Scan Button	37
Scan Bar Codes	39
About Scanning Configuration Bar Codes	39
Use the Scan Demo App	40
Change the Scan Demo Symbology Settings	40
Use the Imager as a Flashlight.....	41

Chapter 4 - Use the Phone **43**

About the Phone.....	43
Add or Switch Between Network Carriers	44
Select a SIM Card Slot	44
Activate the UMTS Phone.....	45
Activate the CDMA Phone	48
Make a Phone Call.....	49
Answer the Phone	49
Switch Apps During a Phone Call.....	50
Make an Emergency Phone Call.....	50
Configure Phone Settings	50

Chapter 5 - Use the Camera **51**

About the Color Camera	51
How to Zoom	51

Take a Photo.....	51
Change Camera Settings.....	52
Record a Video	53
Change Video Settings	53

Chapter 6 - Configure the Computer..... 55

How to Configure the Computer.....	55
Start the Settings App	55
About the Structure of the Settings App	56
About Network Communications	61
Connect to a Wi-Fi Network	61
Configure Proxy Settings for a Wi-Fi Network	62
Disable Wi-Fi Notifications and Set WLAN Radio Sleep Parameter	62
Connect to an Ethernet Network.....	62
How to Connect to Virtual Private Networks	63
Add a VPN	63
Connect to a VPN.....	63
Edit VPN Information	64
About Wireless Security.....	64
About Certificates	64
Load a Certificate	65
Disable or Remove Certificates	65
About Bluetooth Communications	66
Connect a Bluetooth Device	66
Rename the Computer and View File History	67
Rename or Unpair a Paired Device.....	68
About Serial and USB Communications.....	68
USB Troubleshooting.....	68
How to Share Your Mobile Data Connection	69
Share the Data Connection Through USB or Bluetooth.....	69
About Near Field Communication (NFC)	69
Developer Information.....	70
About Provisioning Mode	70

Enable or Disable Provisioning Mode	71
Chapter 7 - Manage and Maintain the Computer	73
About Software Updates	73
About Transferring Files via USB Connection	73
Install Software Updates with AutoInstall.....	74
Optional microSD Card Method	74
About the Honeywell Upgrader	75
Install OTA Updates	75
Reboot (Restart) the Computer	76
About an Enterprise Data Reset.....	77
Before You Begin.....	77
Enterprise Data Reset the Computer.....	77
About a Factory Data Reset.....	78
Before You Begin.....	78
Factory Data Reset the Computer.....	78
Clean the Computer	79
Appendix A - Specifications	81
Computer Agency Information	81
Label Locations.....	81
Physical and Environmental Specifications	82
Bar Code Symbolologies	82
N6600 Slim Imager Engine Reading Distances.....	83
N6600 Slim Imager Engine Field of View/Resolution	84

Customer Support

Technical Assistance

To search our knowledge base for a solution or to log in to the Technical Support portal and report a problem, go to www.hsmcontactsupport.com.

For our latest contact information, see www.honeywellaidc.com/locations.

Product Service and Repair

Honeywell International Inc. provides service for all of its products through service centers throughout the world. To find your service center, go to www.honeywellaidc.com and select Support. Contact your service center to obtain a Return Material Authorization number (RMA #) before you return the product.

To obtain warranty or non-warranty service, return your product to Honeywell (postage paid) with a copy of the dated purchase record. To learn more, go to www.honeywellaidc.com and select **Service & Repair** at the bottom of the page.

For ongoing and future product quality improvement initiatives, the mobile computer comes equipped with an embedded device lifetime counter function. Honeywell may use the lifetime counter data for future statistical reliability analysis as well as ongoing quality, repair and service purposes.

Limited Warranty

For warranty information, go to www.honeywellaidc.com and click **Get Resources > Product Warranty**.

ABOUT THE COMPUTER FEATURES

This chapter introduces the Dolphin CT60 Mobile Computer with the Android 7 operating system. Use this chapter to learn about the basic computer features, functions, and accessories.

About the Dolphin CT60 Mobile Computer

Dolphin CT60 mobile computers, built on the Mobility Edge™ platform, deliver real-time connectivity, advanced data capture, and future-proof investment protection. All CT60 models come equipped for fast Wi-Fi connectivity with a WLAN 802.11 a/b/g/n/ac radio and Bluetooth (v5.0) technology that includes Bluetooth Low Energy (BLE) support. CT60L1N models provide additional connectivity with a wireless WWAN radio for high speed data and quality voice support across all network technologies. CT60 WWAN models also include an integrated global positioning satellite (GPS) receiver that supports GPS protocols including, Simultaneous GNSS Receiver Support for GPS, GLONASS, Galileo and Beidou GPS.

Note: Throughout this manual, all versions of the mobile computer are referred to as the CT60 unless information is specific to a particular model.

Model Overview

Standard Feature	Model CT60LON	Model CT60L1N
Android 7 operating system	x	x
2.2 GHz Qualcomm Snapdragon™ 660 octacore processor	x	x
3 GB/4 GB DDR4 RAM, 32 GB flash memory	x	x
Large, high definition, bright color, outdoor-readable display with responsive multi-touch capacitive touch panel. Automatic switching between glove and finger modes.	x	x
Integrated ambient light sensor, proximity sensor, accelerometer, gyroscope, magnetometer, and pressure sensor	x	x
High performance 2D imager with ergonomic scan buttons	x	x

Standard Feature	Model CT60L0N	Model CT60L1N
WLAN IEEE 802.11a/b/g/n/ac radio; Wi-Fi certified	x	x
Bluetooth™ V5.0 and Bluetooth Low Energy (BLE) technology support	x	x
NFC technology for short-range wireless data exchange	x	x
Wireless WWAN radio for high speed data and quality voice support across all network technologies		x
Dual micro-SIM slots		x
Integrated GPS receiver; GPS Supported Protocols: Simultaneous GNSS Receiver Support for GPS, GLONASS, Galileo and Beidou		x
Mid-tier rugged specifications with IP67 sealing	x	x
Customer-accessible microSD™ slot for removable memory cards up to 512 GB (SDXC/SDHC/SDIO-compliant)	x	x
Value-added software components supporting specialized imaging and OCR functions	x	x
13-megapixel color camera, 4K video with image stabilization and advanced software features for enhanced exposure control	x	x

Note: To learn more, see [Appendix A: Specifications](#) beginning on page 81.

Features of the CT60

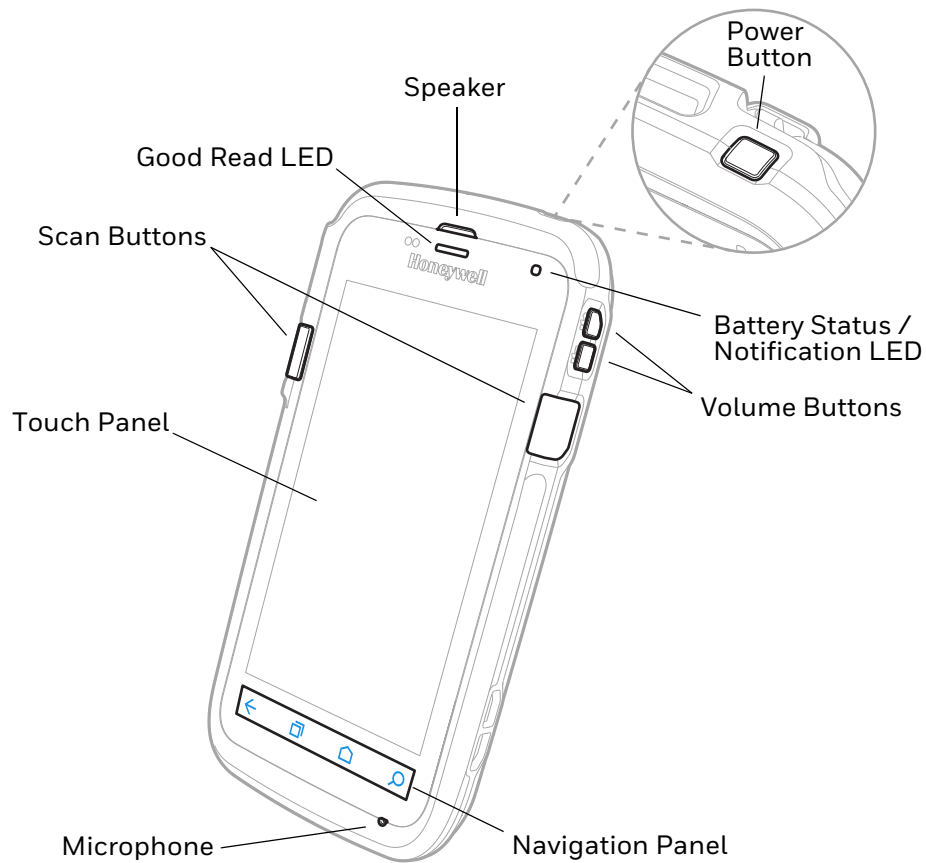

Note: Hand strap not shown.

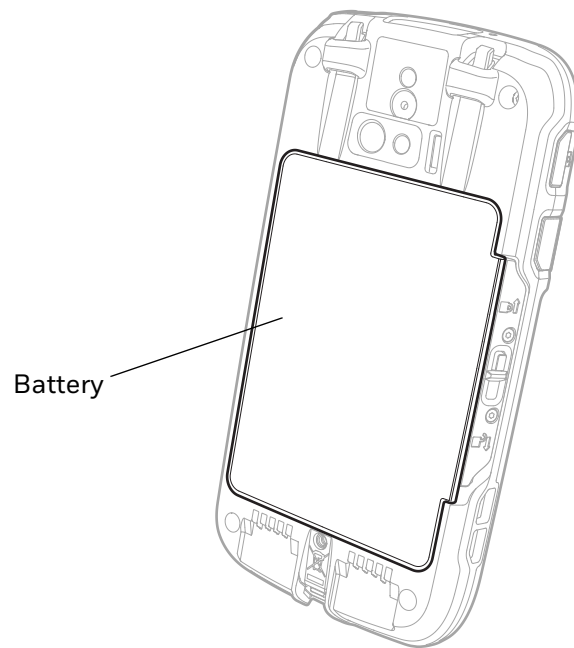
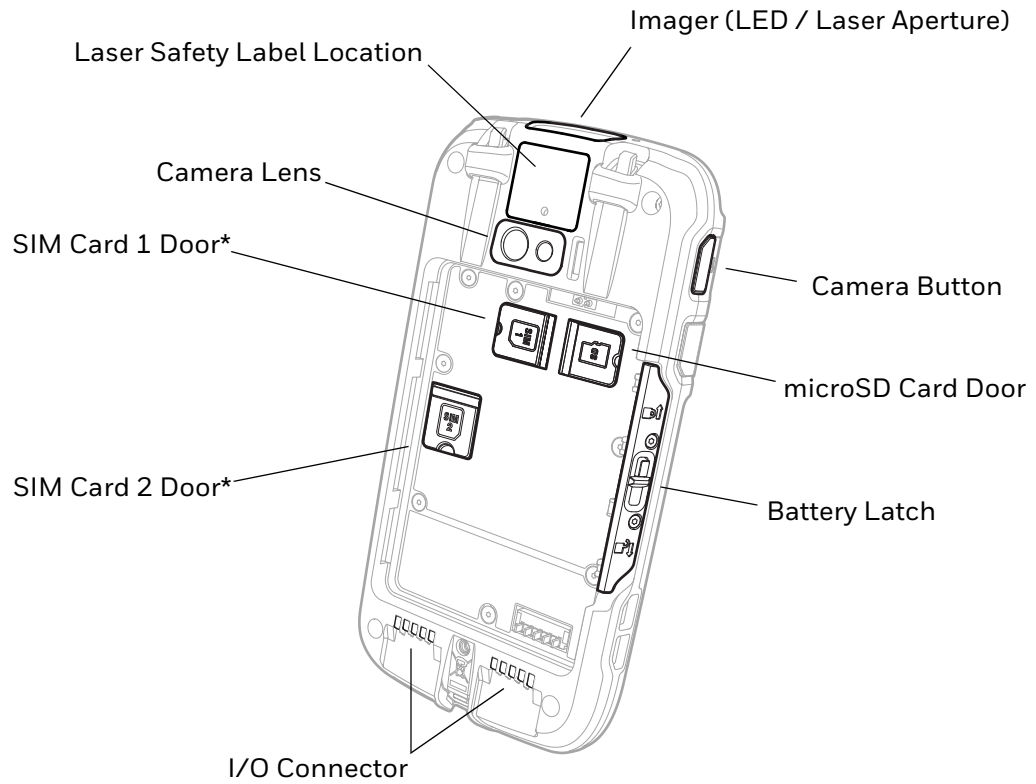

* Phone feature is available only on CN80L1N models. When using a UICC card for NFC Secure Element NFC link encryption, install the card in SIM slot 1. SIM 2 feature is available only on CN80L1N models.

About the Battery

The computer uses a rechargeable 3.6 V Li-ion battery as its main power source. The battery has a 14.6 watt hour capacity. Several factors determine the life of your battery, such as display brightness, display timeout, input device, extreme temperature, and your usage. Honeywell recommends that you keep the battery charged at all times to prevent data loss.

Dolphin CT60 computers are designed for use with battery model CT50-BTSC (p/n 318-055-001 and 318-055-005) manufactured for Honeywell International Inc. Contact your local sales representative for replacement batteries.



Caution: Read [Battery Recommendations and Safety Precautions](#) on page 9 and all cautionary markings on the battery, charging peripheral, and device using the battery before attempting to install, use, or charge the battery.

Charge the Battery Before Use

Dolphin CT60 computers ship with the battery significantly discharged of power. Fully charge the battery before using your computer for the first time.

You can charge the battery with a Dolphin CT50 series charging accessory before or after you install the battery in the computer. A fully discharged battery charges in approximately **6 hours**.

To charge the battery before you install it in the computer:

- Insert the battery into the Honeywell Quad Battery Charger or the battery well of a CT50 HomeBase or eHomeBase.

To charge the battery after installing it in the computer:

- Insert the computer into a CT50 HomeBase, eHomeBase, ChargeBase, NetBase, USB Adapter, or Vehicle Power Adapter.

Note: *Using the computer while charging the battery increases the time required to reach a full charge.*

Replace the Battery

If your battery power is low, you need to either charge the battery in the computer, or replace it with a charged battery.

To replace the battery:

1. Save your files and close any open applications.
2. Press and hold the **Power** button until the options menu appears.
3. Tap **Power Off** and then **OK** to verify.

4. Disconnect one end of the hand strap from the computer.

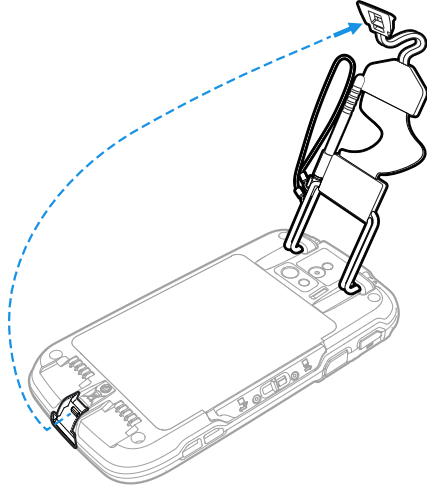

5. Press and hold down the small button on the battery latch, and then slide the latch toward the bottom of the computer to unlock the battery.

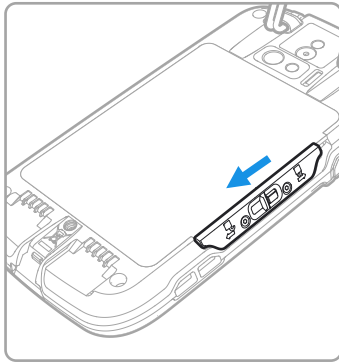

6. Lift up on the edge of the battery and remove it from the computer.

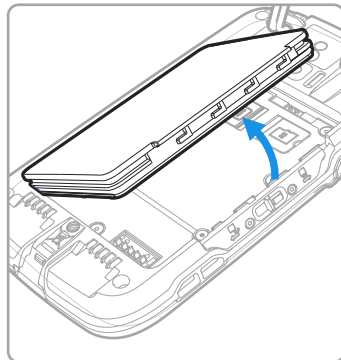







7. Insert the charged battery into the computer.
8. Apply pressure to the battery and slide the lock toward the top of the computer into the locked position.
9. Attach the hand strap.
10. Press the **Power** button.

About the Battery Status

Use the battery icon in the Status bar to see the charge level of your battery. If you want more detailed information on your battery, such as usage time, charge remaining on the battery, or battery health information, open the

Settings app  and tap either **Battery** or **Battery Monitor**.

Battery Status Icons

Icon	Status
	The battery charge is at 100%.
	The battery charge is at 50%.
	The battery charge is low. You need to charge or replace the battery soon.
	The battery is critically low. You need to replace the battery now or connect the computer to a charging accessory.
	The computer is connected to external power and the battery is charging.
	There is a battery error. Install another battery. If the problem persists, call Honeywell Technical Support.

The Battery status LED in the upper right corner of the computer indicates the charging status of the battery.

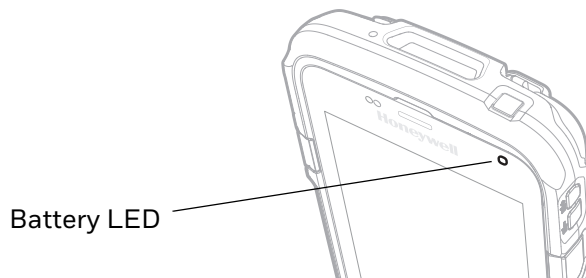

Out-of-Box Battery Status LED (Honeywell Battery LED) Behavior

Connected to Power	LED State	Description
No	Blinking amber	Battery level is below 20%
No	Off	Battery level is more than 20%
Yes	Steady amber	Battery level is between 0% and 60%
Yes	Blinking green	Battery level is between 60% and 95%
Yes	Steady green	Battery level is above 95%
Either	Blinking red	Battery error

Change the Battery Status LED Behavior

You can change the behavior of the Battery status LED if the out-of-box behavior for a charging battery (blinking green) is not acceptable to your environment.

You can choose one of three options:

- Default Battery LED
- Honeywell Battery LED (out-of-box setting)
- No Battery LED

Use the Default Battery LED setting if you want the status LED to turn on steady amber and then steady green when charging. To learn more about this option, see [Default Battery LED Descriptions](#).

Select the No battery LED setting if you want to use the LED as a notification LED for applications or device management solutions. For more information on how to use the LED as a notification LED, see <http://developer.android.com/guide/topics/ui/notifiers/notifications.html>.

Default Battery LED Descriptions

Connected to Power	LED State	Description
No	Blinking red	Battery level is below 15%
No	Off	Battery level is 15% or more
Yes	Steady red	Battery level is below 15%
Yes	Steady amber	Battery level is between 15% and 90%
Yes	Steady green	Battery level is 90% or more

To change the battery status LED behavior:

1. Swipe up from the bottom of the Home screen to access all apps.
2. Tap **Settings**  > **Battery LED**.
3. Choose one of these options:
 - Default Battery LED
 - Honeywell Battery LED (out-of-box setting)
 - No Battery LED

Check the Battery Level and Usage

In addition to the Battery status icon and LED, you can monitor the battery status from the Settings app.

1. Swipe up from the bottom of the Home screen to access all apps.
2. Tap **Settings**  > **Battery**.

The current percentage of battery power remaining and the amount of usage time left on the battery appear on the screen. A list shows the battery usage for individual apps and services. For usage details, select one of the apps or services in the list. You can also access the Battery saver feature from the battery screen.

About Battery Life and Conservation

If you store the batteries outside of the computer for long periods of time, they slowly discharge. To maintain battery performance, storing the battery in a charger is recommended.

When You Want to:	Do this to Save Battery Power:
Use the computer and the low battery status icon appears or the battery light turns on.	<ul style="list-style-type: none">• Connect the computer to a charging accessory.• Replace the battery. Press and hold the Power button and then select Power off from the menu. Tap OK to verify. After the computer turns off, remove the battery and insert a fully charged battery.
Stop using the computer for 5 minutes or more.	Make sure that the low battery status icon is not on the screen and that the battery status LED is not on. Press the Power button to suspend the computer.
Store the computer for more than a day.	<ul style="list-style-type: none">• If you are storing the computer for a few days (such as over the weekend), install a fully charged battery or connect the computer to a power source.• If you are storing the computer for a longer period of time, remove and charge the battery. When the battery is done charging, store both the battery and the computer in a cool location.• If you store the battery for several months, recharge the battery periodically to keep it at peak performance.
Store the battery outside of the computer.	Store the batteries in a charger.

Battery Recommendations and Safety Precautions



Caution: Improper battery replacement or incompatible device usage may result in risk of burns, fire, explosion, or other hazard. Dispose of lithium-ion batteries according to local regulations. Risk of fire and burns if improperly handled. Do not open, crush, heat above 60°C (140°F), or incinerate.

- For maximum battery life, charge the battery at 20 °C (68 °F) to 25 °C (77 °F) and store at 20 °C (68°F) with a 50% charge.
- Do not store the battery at temperatures above 60 °C (140 °F). Storage above 60 °C (140 °F) may damage the battery.
- Charge the battery before use. Battery ships with only a partial charge.
- See [Charge the Battery Before Use](#) on page 4 for approved charging methods. Use of this battery in other devices could result in damage to the device or battery.
- Avoid dropping the battery or computer. If you suspect that the battery or computer is damaged, send it to Honeywell service center for inspection.
- Replace the battery only with another CT50-BTSC model battery. This battery has been tested in accordance with applicable safety standards. Contact your Honeywell sales representative or distributor if this battery is no longer available.
- Discarded batteries may create a safety hazard. Before disposal, cover the battery contacts with electrical insulating tape.
- Do not modify the battery or attempt to insert foreign objects into it.
- Do not solder directly to the battery contacts.
- Do not drop the battery or apply mechanical shocks or pressure to it.
- Do not disassemble or open, crush, bend or deform, puncture, shred or burn the battery.
- Do not immerse the battery in water or get the battery wet.

Enable Airplane Mode

If you do not need to connect to any wireless networks, you can enable Airplane mode to turn off the radios and save battery power.

1. Swipe up from the bottom of the Home screen to access all apps.
2. Tap **Settings** .
3. In the Wireless & Networks section, choose **More**.
4. Tap the toggle button next to **Airplane mode**. An airplane icon appears in the status bar to indicate Airplane mode is turned on.

Power On the Computer

After you have fully charged and installed a battery, power on the computer for the first time:

- Press and release the **Power** button.

Welcome Screen

The first time you power on the computer, a Welcome screen appears. Follow the prompts on the screen as the setup wizard has you:

- set the default language.
- set up the Wi-Fi network connections.
- set the time, date, and time zone.
- personalize (name) the computer.
- set up security and privacy options.

Once you complete the Setup Wizard, the Welcome screen no longer appears when you power on the computer and Provisioning mode is automatically turned off (disabled). Scanning a bar code to install of applications, certificates, configuration files, and licenses on the computer is restricted. To learn more [About Provisioning Mode](#), see page 70.

Unlock the Screen

The screen lock automatically activates every time the computer is turned on or when the computer wakes from sleep mode.

- Swipe up from the lock icon at the bottom of the screen.

The level of security provided depends on the type of lock set (e.g., Swipe, Pattern, PIN, or Password). The default setting (Swipe) provides no protection against unauthorized access to your computer.

Change the Screen Lock to Protect the Computer

After you start using the computer, you should change the screen lock to prevent unauthorized persons from accessing the computer without a password, pin, or pattern to unlock the touch screen once it has been locked.

The recommended setting for the Screen Lock is to enable a Password lock. Use a strong password value (e.g., include numbers, characters, special characters, and mix character case).

1. Swipe up from the bottom of the Home screen to access all apps.
2. Tap **Settings**  > **Security** > **Screen lock**.
3. Choose one of the following options:
 - **None**
 - **Swipe**
 - **Pattern**
 - **PIN**
 - **Password**
4. Follow the on-screen prompts to complete the setup.
5. Exit the Settings app.

Select a Touch Screen Profile to Optimize Performance

Optimize screen interactions by selecting a touch screen profile designed specifically for your use case. For example, if you wear gloves, set the touch screen profile to Glove use enhanced for the best touch screen response.

Note: *Maximum glove thickness of 2 mm (0.08 inches) for touch screen response.*

1. Swipe up from the bottom of the Home screen to access all apps.
2. Tap **Settings**  > **Touch Screen Profiles**.
3. Choose one of the following options:
 - **Default**
 - **Touch enhanced**
 - **Glove use enhanced**
 - **Stylus enhanced**
4. Exit the Settings app.

Configure the Screen Backlight

The display has an ambient light sensor that automatically adjusts the backlight intensity to conserve power and ensure the display is readable. You can also manually set the backlight intensity if you do not want to use the automated adaptive brightness feature.

1. Swipe up from the bottom of the Home screen to access all apps.
2. Tap **Settings**  > **Display**.
3. Choose one of the following options:
 - To have the computer automatically adjust the brightness for your work environment, turn on the **Adaptive brightness** setting. You can tap **Adaptive brightness** to toggle the feature on or off.

To set the brightness level manually, verify the Adaptive brightness feature is turned off, and tap **Brightness level**. Adjust the slider to set the brightness level.

About the Good Read LED

The Good Read LED indicates the status of the scanner. To learn more about how to use and configure the imager engine for scanning, see [Chapter 3: Use the Image Engine](#) beginning on page 31.

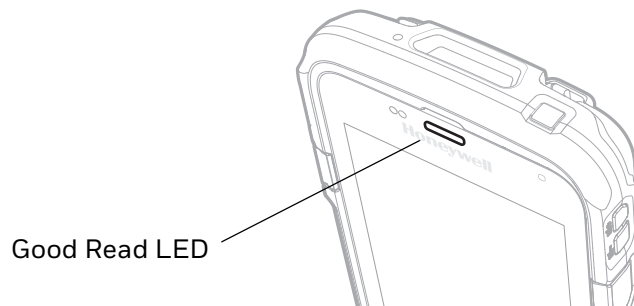

Good Read LED Descriptions

LED Color	Description
Green	Good read of a bar code.
Blinking green	The data collection engine is processing or starting up.

About the Audio Features

The CT60 has a speaker, a microphone, and several software tools to configure sound volume or enable vibration feedback.

Adjust Speaker Volume

Use the volume buttons on the right side of the computer to adjust the volume of ringtones, media, notifications or alarms.



1. Press either the **Volume Up** or **Volume Down** button. The volume slider appears.

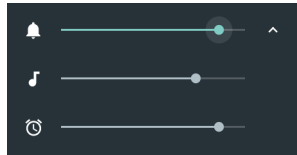

2. Tap the down arrow  to expand the options.



Use the stylus or the Volume buttons to adjust each volume type.

- Use the  slider for notifications and rings.
- Use the  slider for media (e.g., music, videos and other media).
- Use the  slider for alarms.

Enable Vibrate Mode

You can use the Volume down button to quickly enable Vibrate mode so the computer vibrates instead of emitting sound for notifications and rings. If you still want to hear alarms, turn on the Alarms only feature.



1. Press the Volume down button until the computer vibrates.

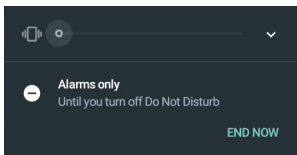

2. To turn on the Alarms only feature, press the Volume Down button again with the volume slider open.



The status bar at the top of the screen indicates the active mode:

- When Vibrate mode is active,  appears.
- When Alarms only mode is active, the Do Not Disturb icon  appears.

Audio Settings

This section describes the audio and sound settings you can configure in the Settings app.

- To change audio settings, start the **Settings** app  and tap **Sound**.
Sound Settings

Setting	Description
Media Volume Alarm Volume Ring Volume	Use the sliders to set the volume for media (e.g., music, videos, and games), alarms and rings (notifications and ringtones).
Also Vibrate for calls	Select to enable vibrate mode when the phone is ringing.
Do not disturb	Select to set which notifications to let through when you have Do not disturb turned on and when you want to be left alone.
Phone ringtone	Select a default ringtone.
Default notification ringtone	Select a notification sound.
Default alarm ringtone	Select a alarm sound.
Emergency broadcasts	Select to configure Emergency alert settings. Turn alerts on or off, specify tone, vibrate or text-to-speech.
Other sounds	
Screen locking sounds	Enable or disable an audio tone when the screen is locked.
Charging sounds	Enable or disable an audio tone when the computer is charging.
Touch sounds	Enable or disable audio sounds when you use the touch screen.
Vibrate on tap	Enable or disable vibrate mode when you touch the screen.

Insert a microSD Card

You can use a microSD card to increase file storage capacity or to install software. Honeywell recommends the use of Single Level Cell (SLC) industrial grade microSD or microSDHC memory cards with the computer for maximum performance and durability.

Note: *Format the memory card before initial use.*

1. Save your files and close any open applications.
2. Press and hold the **Power** button until the options menu appears.
3. Tap **Power Off** and then **OK** to verify.
4. Disconnect one end of the hand strap from the computer.

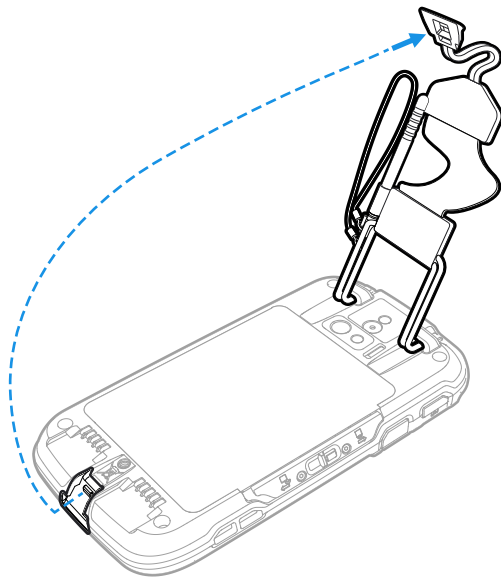

5. Press and hold down the small button on the battery latch, and then slide the latch toward the bottom of the computer to unlock the battery.

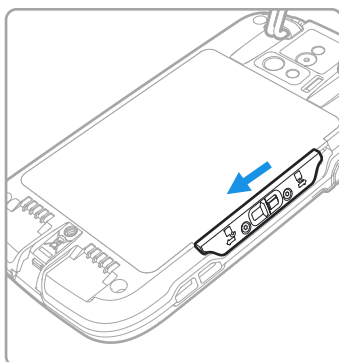

6. Lift up on the edge of the battery and remove it from the computer.

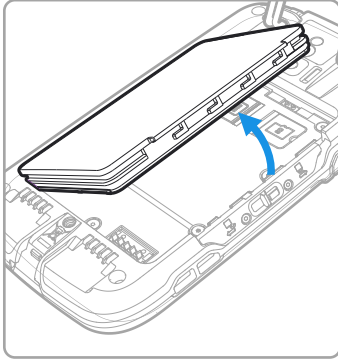

7. Lift up the edge of the SD card access door.

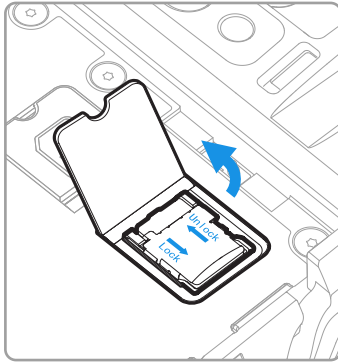

8. Press down gently and slide the card holder toward the open access door. Lift the edge of the holder up.

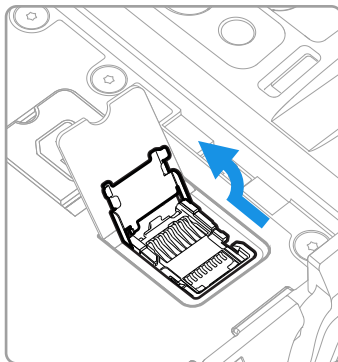

9. Insert the microSD card into the card holder with the contacts facing out.

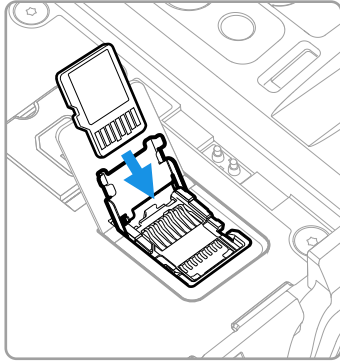

10. Close the holder with the card inserted. Press down gently on the card holder and slide it into the locked position.

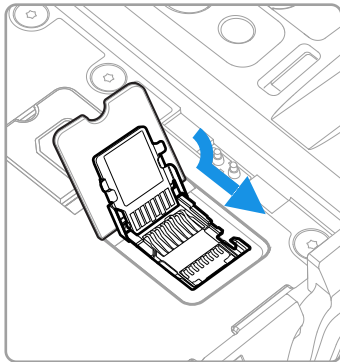

11. Close the SD card access door.

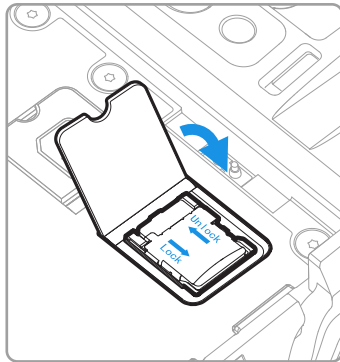

12. Install the battery and slide the battery latch toward the top of the computer to engage the lock.

13. Install the hand strap, and then turn on the computer.

How to Transfer Files

To transfer files you need to physically connect the CT60 mobile computer to your workstation (e.g., laptop or desktop computer) through a USB connection. When the mobile computer is connected and USB is configured for file or photo transfer, use a file browser (e.g., File Explorer or Windows Explorer) on your workstation to transfer files between the two computers. If you are transferring files to and from a Mac, use the Android File Transfer application (available from www.android.com/filetransfer).

Note: *File transfer through a USB connection is disabled by default. You need to configure the USB connection for transferring files or photos.*

You can use these accessories to connect your mobile computer to your workstation:

- HomeBase or eHomeBase, and a standard USB Type B to A cable
- USB adapter

Configure USB Connection and Transfer Files

Note: *The CT60 supports Hi-Speed USB communications (USB 2.0) with a maximum data transfer rate of 480 Mbps.*

1. Connect the CT60 to your workstation.
2. On the CT60, swipe down from the top of the screen to see the notifications.
3. Tap **USB charging this device**.
4. Select either **Transfer files** or **Transfer photos (PTP)**.
5. Open the file browser on your workstation
6. Browse to the CT60. You can now copy, delete, or move files between the CT60 and your workstation.

Accessories for the Computer

The Dolphin CT60 ships with a battery, hand strap and stylus. All other accessories are ordered and shipped separately. For help, contact your local sales representative.

Note: *Dolphin CT60 mobile computers are compatible with most Dolphin CT50 accessories. Check with your local sales representative about accessory compatibility before ordering.*

Accessory	Description
Battery (Model CT50-BTSC)	Replacement or spare 3.6 V Li-ion rechargeable battery for the CT60 (P/N 318-055-001 and 318-055-005).
eHomeBase (Model CT50-EB)	Use the eHomeBase to hold a computer with a battery installed, charge a spare battery pack, charge the main battery pack, and provide power to the mobile computer. The eHomeBase has a USB client connector (Type B) as well as an Ethernet connector.
HomeBase (Model CT50-HB)	Use the HomeBase to hold a computer with a battery installed, charge a spare battery pack, charge the main battery pack, and provide power to the mobile computer. The HomeBase has a USB client connector (Type B).
ChargeBase (Model CT50-CB)	The ChargeBase is a 4-slot charging cradle that can power four computers, and charge their main batteries in 6 hours.
NetBase (Model CT50-NB)	The NetBase enables up to four computers to communicate with a host device over an Ethernet network. The Net Base also provides a second RJ45 Ethernet port for connection to an additional device such as a printer, workstation, or another Net Base.
Vehicle Power Adapter (Model CT50-MC)	Use the vehicle power adapter to charge the battery installed in the computer from the accessory port in your vehicle.
Vehicle Dock (Model CT50-MB)	Use the vehicle docks to hold and charge the computer while using it on a vehicle. The vehicle dock also contains a USB host port.
Quad Charger (Model CT50-QBC)	Use the quad charger to charge up to four batteries.
USB Adapter (Model CT50-USB)	Use this snap-on adapter to connect to a USB port for transferring data or charging your computer.
Scan Handle	Attach the scan handle to the CT60 mobile computer for easier grip and trigger action when scanning labels.
DEX Adapter (Model DEX-BLE-1)	Use the DEX adapter to easily connect to direct store delivery (DSD) receiving systems including DEX/UCS store systems, vending machines, and other retail equipment.
Holster	Use the holster to carry the computer hands-free in the work environment. You can choose between three different holsters.

ABOUT THE USER INTERFACE AND APPLICATIONS

Use this chapter to learn about the user interface and how to interact with the screen. You can also use this chapter to learn about the Honeywell applications on the computer.

About the User Interface

The Android 7 operating system provides a touch-friendly and easy-to-navigate user interface. When you turn on the mobile computer, the Home screen is the first screen that appears after language provisioning and the startup wizard is complete.

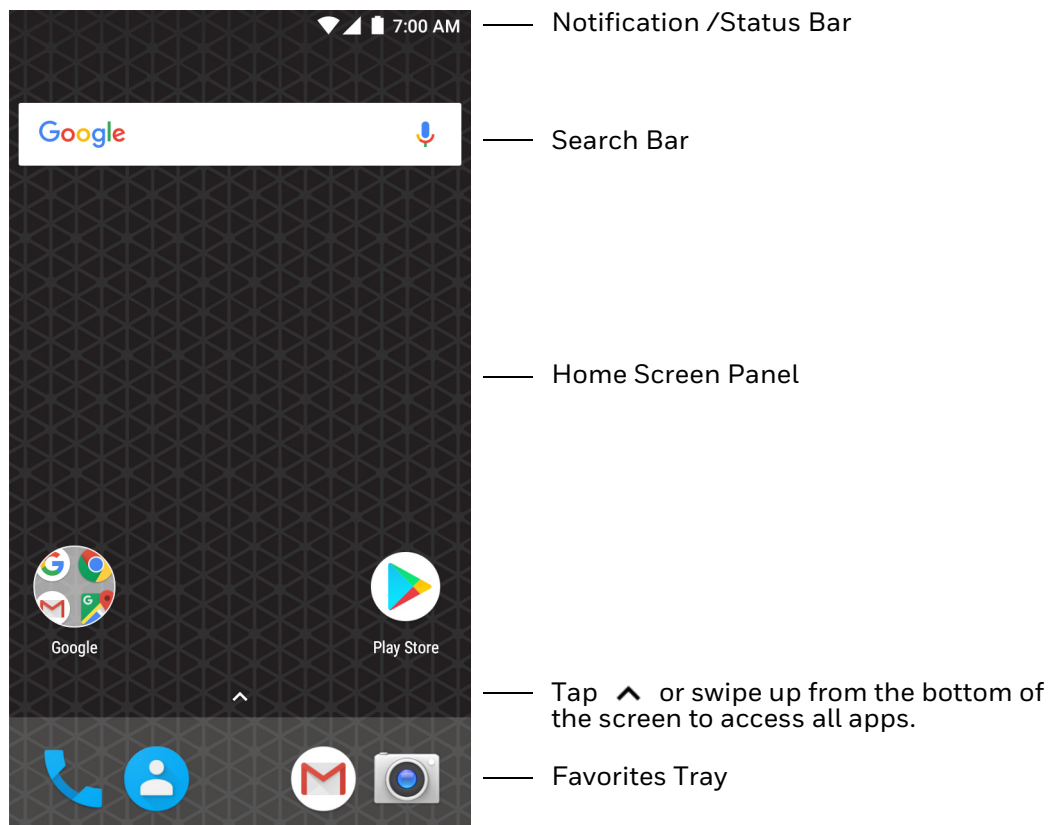





Home Screen Features

Item	Description
Notifications panel / Status bar	Status icons to the left tell you when an app has sent notifications, such as an arriving message. System icons to the right display the current wireless and network connection state and battery level.
Search bar	Search the Internet or the computer using Google™. Touch  to initiate a voice search or command.
Home Screen Panel	You can create more than one custom Home screen panel. Swipe left or right on the Home to switch between your custom panels.
Favorites tray	App icons in the customizable tray are visible on all Home screen panels.

Navigation and Function Buttons

Your mobile computer has virtual buttons on the front panel below the Favorites tray and hardware buttons located on the sides for easy navigation and quick feature access when using the computer.



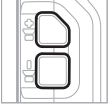
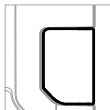
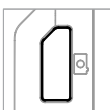













Navigation and Function Buttons

Button	Description	
	Back	Return to the previous screen.
	Recent Apps	View and switch between recently used apps.
	Home	Return to the Home screen.
	Search	Start a search on the computer or the Internet.
	Volume	Raise or lower the volume of the speaker.
	Scan	Press the right or left scan button to trigger the scanner.
	Camera	Press to open the camera app and take a photo.

About Status Bar Icons

Status and notification icons show you the current status of your network, the battery, notifications, and sounds. Use the table below to understand some of the most common icons.

Status and Notification Icons

Icon	Description	Icon	Description
	Pending alarm and Alarm is set		Vibrate mode is turned on
	New text message or multimedia message		Airplane mode is turned on.
	Error with text or multimedia message delivery		Bluetooth is turned on.
	New email		SD card is full
	Computer is connected to a PC with a USB cable		Wi-Fi network connected with full signal strength
	Synchronizing data		Wi-Fi network connected but no signal strength
	Error with sync or sign-in		Phone connected with full amount of bars.
	Computer is connected with Ethernet		Phone connected with full amount of bars but no Internet connection.



Remap a Button

You can change the default function of the Left Scan, Right Scan, or Camera buttons as well as the Back, Recent, Home, and Search virtual buttons.

1. Swipe up from the bottom of the Home screen to access all apps.
2. Tap **Settings**  > **Key Remap**.
3. Tap the plus sign (+).
4. Press the button you want to remap or select one of the virtual buttons.
5. Tap **OK**.
6. Tap **Keys** or **Applications** to view the available functions.
7. Select the function you want assigned to the button. The function you selected now appears next to the button name.

Restore Default Button Action

To restore the button default action:

1. Swipe up from the bottom of the Home screen to access all apps.
 2. Tap **Settings**  > **Key remap**.
 3. Tap the clean icon .
 4. Choose the remapped button(s) you want restored to the default setting.
 - Tap the check box next to the button.
- OR
- Tap **All Select** to choose all the buttons.
 5. Tap **Delete**.

View and Manage Notifications

You can view recent events on the computer, manage system notifications, change a setting or quickly respond to an app notification by opening the notifications panel.

When a notification icon appears in the status bar at the top of the screen:

1. Swipe down from the top of the screen to open the notifications panel.
2. Respond to the notification. You can take one of the following actions:
 - Tap the notification to open the associated app.
 - Tap a quick-reply or action command (e.g., Reply, Archive) if available.
 - Swipe the notification sideways, off the screen to dismiss it. Note that some notifications cannot be dismissed.
 - Slide the notification left or right to reveal the settings icon . Choose between **Show notifications silently**, **Don't silence**, or **More Settings**.

To close the notification panel, swipe up from the bottom of the screen, or tap the Back or Home buttons.

Open Quick Settings

Use the Quick Settings screen to quickly access common settings. Tap an icon to toggle the feature on/off or to open additional settings.

- To open Quick Settings, swipe down twice from the status bar at the top of the screen.
- To close Quick Settings, tap the top of the screen, Back or Home buttons.

Customize the Home Screen

You can add application icons to any Home screen for easier access.

1. Swipe up from the bottom of the Home screen to access all apps.
2. Tap and hold the app you want to add. The computer vibrates, and then switches to a smaller view of the Home screen panels.
3. Drag and drop the app icon into place.
 - If you want to add another home screen, drag the icon to the right edge of the screen before releasing the icon.
 - If you want to create a folder, drag and drop the icon on top of another icon.

To add a Widget:

1. Tap and hold an empty section of the Home screen.
2. Tap **Widgets**.
3. Tap and hold the Widget you want to add.
4. Drag and drop the Widget into place on the Home screen.

Customize the Favorites Tray

Modify the Favorites tray to contain the apps you use the most.

1. Tap and hold the app icon you want to replace on the Favorites tray.
2. Drag and drop the app on “**X Remove**” at the top of the screen.
3. Swipe up from the bottom of the screen to access all apps.
4. Tap and hold the icon of the app you want to add.
5. Drag and drop the icon into position on the Favorites tray.

Use Google™ Search

Use the Google Search field at the top of the Home screen to help you find anything you need on the computer or on the web.

1. At the top of any Home screen, tap inside the Google Search box and begin to type your search term.

As you type, suggestions from Google web search appear below the Search box, and results from the computer (such as apps or contacts) appear below the web search results.

2. Tap a suggestion to search for it immediately, or touch the arrow to add the term to the search field without starting to search.

About Screen Gestures

Use your fingers or the stylus to manipulate icons, buttons, menus, the on-screen keyboard, and other items on the screen.

- **Tap**

Tap to select something, toggle a setting on or off, or activate a field for text entry. An on-screen keyboard automatically appears for text entry.

- **Tap and hold**

Tap and hold an item but do not lift your finger or stylus until an action occurs.

- **Drag and drop**

Tap and hold an item, and then slide your stylus or finger across the screen until you reach the target position. Lift your finger or stylus off the screen to drop the item in place.

- **Swipe**

Quickly move your finger across the screen, without pausing when you first touch. For example, you can swipe a Home screen left or right to view the other Home screens.

- **Slide**

Slowly move your finger across the screen, without pausing when you first touch. For example, you can slide a notification to the left until the Settings gear is revealed.

- **Double-tap**

Tap quickly twice on a web page, map, or other screen to zoom in. Double-tap again to zoom out.

- **Pinch**

In some apps, you can zoom in and out by placing two fingers on the screen at once and pinching them together (to zoom out) or spreading them apart (to zoom in)

Set the Time Zone









The computer gets the current date and time from its network connection. If preferred, you can change this behavior and manually set the time zone for your location.





1. Swipe up from the bottom of the Home screen to access all apps.
2. Tap **Settings**  > **Date & time**.
3. Tap **Automatic time zone** to turn off the feature.
4. Tap **Select time zone** and choose the time zone for your location.

About Honeywell Applications

Honeywell applications help you troubleshoot and connect your computer to other devices and networks. Some of the applications in this table are located in the Power Tools app. To learn more about Honeywell Power Tools, go to www.honeywellaidc.com to download the *Dolphin Power Tools User Guide*.

Honeywell Applications Available on the Computer

Icon	Application	Description
	AutoInstall Settings	Enable the AutoInstall feature, to automatically install *.zip or *.apk files containing applications saved in the Internal shared storage\honeywell\autoinstall folder and IPSM card\honeywell\autotinstall folder on the computer during the power-up boot or reboot process.
	Carrier Select	The SIM Selection app only appears on CT60L1N models. Use the app to quickly change your network carrier.
	Demos	Honeywell Demo apps demonstrate the basic capabilities of the computer and are not intended as functional business solutions. The demos included, demonstrate scanning, signature capture, NFC functionality, and printing via Bluetooth technology. Information on how to create custom applications for your Honeywell mobile computer can be found in the Honeywell Software Development Kit (SDK) for Android, available from the Technical Support Downloads Portal .
	HUpgrader	Use to the HUpgrader app to view the current OTA version on the computer, check for updates, or initiate an OTA upgrade from storage.
	SIM Selection	The SIM Selection app only appears on CT60L1N models equipped with dual SIM slots. Use the SIM Selection app to configure and switch between two SIM cards installed in the computer.
Dolphin Power Tools		
	BattMon	BattMon provides information on the charge status and health of the battery, and provides access to activate battery status notifications and battery charging history logs.
	Configure Autorun	Configure Autorun provides the ability to set applications to automatically run after a reboot.
	Diagnostic Information	Diagnostic Information provides access to system statistics, notifications and version information about the computer.
	EZConfig	EZConfig supports advanced customization and configuration of the hand held computer. EZConfig includes a standard XML editor and configuration bar code scanner feature.

Icon	Application	Description
	IPConfig	IPConfig displays, releases and renews IP parameters and supports configurations for static IP addresses.
	Ping	Ping displays an interface for the ping echo request utility. Use Ping to verify communication links or to make sure a specific IP address is working.
	Route	Route displays packet destination across the subnets.
	Wireless Tether	Use to enable range tracking and customize out-of-range alerts for Bluetooth devices paired and tethered to your hand held computer.

Applications You Can Download to the Mobile Computer

You can download Honeywell applications to extend the capabilities of the computer. You may need to purchase an license to run some applications. To learn more about the applications described in this section and other Honeywell software solutions, go to www.honeywellaidc.com > **Browse Products** > **Software**.

About Honeywell Enterprise Browser

Enterprise Browser for Microsoft® Internet Explorer® is a locked-down enterprise Web client application designed for Honeywell computers. It provides a controlled Web application environment that helps enterprises increase productivity and reduce IT management expenses. You can configure Enterprise Browser for your specific application requirements and design custom web applications that run through the Enterprise Browser to provide your users with an easy-to-use yet controlled experience.

If Enterprise Browser is not included on your computer model, you can download a trial version for evaluation. After the evaluation period expires, you need to purchase a license. For more information about Enterprise Browser, visit www.honeywellaidc.com.

About Honeywell Launcher

Launcher is a configurable locked-down menu program designed for Honeywell computers that prevents end-users from accessing the start menu and other non-authorized applications. Use Launcher to provide a platform where your mobile computer users are limited to running only company-approved applications and prevent them from initiating unauthorized configuration changes. You can also use Honeywell Launcher together with Honeywell Enterprise Browser to create a single-purpose device configuration.

If Launcher is not included on your computer model, you can download a trial version of the software for evaluation. After the evaluation period expires, you need to purchase a license. For more information about Launcher, visit www.honeywellaidc.com.



About Enterprise Terminal Emulator

Enterprise Terminal Emulator (TE) is a terminal emulation client designed for enterprise-level data collection. In a single client, Enterprise TE supports multiple emulation protocols. Its features include session persistence, remote management and configuration, and multiple security options. Enterprise TE provides a consistent user interface and a common menu structure (Enterprise Settings), simplifying the use and management of applications running on Honeywell mobile computers.

If Enterprise TE is not included on your computer model, you can download a trial version of the software for evaluation. After the evaluation period expires, you need to purchase a license. For more information about Enterprise TE, visit www.honeywellaidc.com.

Unlock Developer Options

Developer options only appear in the Settings app if you unlock the feature. If you are a developer working with the computer, you can easily unlock the additional settings to use for testing and debugging applications under development for the computer.

1. Swipe up from the bottom of the Home screen to access all apps.
2. Tap **Settings**  > **About phone**.
3. Tap **Build number** seven times. A message appears informing you that you are now a developer.
4. Open **Settings**  and scroll to the bottom of the list.
5. Tap **Developer options**.

USE THE IMAGE ENGINE

Use this chapter to understand how to scan bar codes, configure the scan settings, and capture images using the integrated image engine in the computer.

About the Image Engine

You can use the image engine in the computer as a scanner or camera.

Use the imager as a scanner to read 1D and 2D bar code symbologies, composite symbologies, and postal codes. It also supports omni-directional scanning for greater flexibility in real-world settings. By default, the scanner feature is enabled and uses the default scan profile. You can modify the **Default Profile** or create new profiles for custom applications from the **Settings** app under **Scanning**.

Use the imager as a camera to capture black and white images, such as signatures or pictures of damaged inventory.

Note: *Instead of using the internal imager, you can also use Bluetooth communications to connect the computer to an external scanner, such as the Granit™ 1981i and 1911i.*

About the Scan Wedge Feature

The scan wedge feature sends scanned bar code data to an active application as Android keypad input. To scan a bar code as keyboard input, open an application that accepts text input and then scan a bar code. You can use applications that are coded to use the scanner or applications that receive data through the scan wedge feature. If an application claims the scanner through the BarcodeReader API, the scan wedge feature is temporarily disabled.

You can find information on how to create custom applications for the computer in the *Software Development Kit (SDK)* available for download from the *Technical Support Downloads Portal* at <https://hsmftp.honeywell.com>. Once you create an account and enter the portal, navigate to **Software > Software and Tools > Developer Library > SDKs for Android**.

Change the Scanner Settings

Changes you make to the Default profile apply to all applications with no profile assigned.

1. Swipe up from the bottom of the Home screen to access all apps.
2. Tap **Settings**  > **Scanning**.
3. Tap **Internal Scanner** > **Default Profile**.
4. Select from the following:
 - **Data Processing Settings**,
 - **Symbology Settings**,
 - **Decode Settings**,
 - **Imager Settings**,
 - **Trigger Settings**, or
 - **Notification Settings**.
5. Modify the settings to meet your application needs.

To learn more about, the scanner settings, [Default Scan Settings](#) on page 33.

Restore Default Scan Settings

You can easily discard all changes you made to the Default profile and restore the default values.

Note: *When you choose the Restore all defaults option from a settings screen in a profile, all the settings in that profile return to their default values.*

1. Open the **Default profile**.
2. Tap  in the upper right corner of any of the scan settings screens for the profile.
3. Tap **Restore all defaults**.

Default Scan Settings

Use the following sections to understand the scan settings available for scanner profiles. To learn how to create a new profile, see page 37.

Data Processing Settings

Use the Data Processing Settings to specify how bar code data is processed by the computer.

Data Processing Settings

Setting	Description	Default										
Charset	Select the character set to use when interpreting the bar code data into a string.	ISO-8859-1										
Prefix	<p>Defines the string added before the decoded bar code data. Substitutions occur within the Prefix string values.</p> <table border="1"> <thead> <tr> <th>Substring</th> <th>Replacement Character Code</th> </tr> </thead> <tbody> <tr> <td>\r</td> <td>13</td> </tr> <tr> <td>\n</td> <td>10</td> </tr> <tr> <td>\t</td> <td>9</td> </tr> <tr> <td>\\</td> <td>'\'</td> </tr> </tbody> </table>	Substring	Replacement Character Code	\r	13	\n	10	\t	9	\\	'\'	None
Substring	Replacement Character Code											
\r	13											
\n	10											
\t	9											
\\	'\'											
Suffix	<p>Defines the string added after the decoded bar code data. Substitutions occur within the Suffix string values.</p> <table border="1"> <thead> <tr> <th>Substring</th> <th>Replacement Character Code</th> </tr> </thead> <tbody> <tr> <td>\r</td> <td>13</td> </tr> <tr> <td>\n</td> <td>10</td> </tr> <tr> <td>\t</td> <td>9</td> </tr> <tr> <td>\\</td> <td>'\'</td> </tr> </tbody> </table>	Substring	Replacement Character Code	\r	13	\n	10	\t	9	\\	'\'	None
Substring	Replacement Character Code											
\r	13											
\n	10											
\t	9											
\\	'\'											
Wedge as Keys	List of character values to wedge as keys, represented as a comma-separated list of decimal values.	9,10										
Data Editing Plugin	Specify a Total Freedom data editing plug-in and edit plug-in settings.	None										
Symbology Prefix	<p>Specify a symbology identifier prefix to the bar code data. Options include:</p> <ul style="list-style-type: none"> None Honeywell AIM 	None										

Setting	Description	Default
Launch Browser	<p>Enable or disable URL bar code handling. If a bar code starts with http:// or https://, the browser opens using the bar code data as a URL.</p> <p>Corresponds to BarcodeReader property: PROPERTY_DATA_PROCESSOR_LAUNCH-BROWSER</p>	Enable
Scan to Intent	<p>Enable or disable special handling of scan-to-intent bar codes.</p> <p>Applies to bar codes in one of the following formats: '//' ACTION '//' ACTION '\$' extra-data</p> <p>Where: ACTION and extra-data are any string of characters.</p> <p>Launches an application listening for the intent. Intent action: "com.honeywell.scantointent.intent.action." + ACTION Intent extra: "com.honeywell.scantointent.intent.extra.DATA" contains the remainder of the bar code data after the first '\$' character.</p> <p>Corresponds to BarcodeReader property: PROPERTY_DATA_PROCESSOR_SCAN_TO_INTENT</p>	Enabled
Launch EZ Config	<p>Enable or disable special handling of EZConfig bar codes.</p> <p>Applies to EZConfig bar codes that are encoded with the Aztec symbology and contain specific header data.</p> <p>Corresponds to BarcodeReader property: PROPERTY_DATA_PROCESSOR_LAUNCH_EZ_CONFIG</p>	Enabled

Symbology Settings

Use the Symbology Settings to enable or disable bar code symbologies for the selected scan setting profile.

- Tap the check box next to a symbology name to enable (check mark) or disable (no check mark) decoding for that symbology.
- Tap the symbology name to view and modify additional configuration parameters for the symbology selected.

To view a list of default settings for supported symbologies, see [page 82](#).

Decode Settings

Adjust the Decode Settings when scanning bar codes that are densely packed or poor quality.

Decode Settings

Setting	Description	Default
Center Decode	<p>When enabled, the imager scans and decodes a bar code only if part of the bar code is at the center of the aimer window. This is useful in situations where several bar codes may be very close together in the imager field-of-view.</p> <ul style="list-style-type: none"> • Tap the check box to toggle the feature on or off. • Select Center Decode to adjust the Window dimensions. Honeywell recommends leaving the settings at 50 (default) to define the “center” area for the bar code. <p>Configurable parameters:</p> <ul style="list-style-type: none"> • Window top • Window bottom • Window left • Window Right 	Disabled
Poor Quality 1D Reading	<p>Enable this setting when scanning damaged or badly printed 1-D bar codes to improve bar code read success.</p>	Disabled
Video Mode	<p>Use this setting to specify whether normal or inverse decoding for linear symbologies is enabled during the execution of Decode. By default normal video is enabled. Options include:</p> <ul style="list-style-type: none"> • Normal • Inverse • Normal and Inverse 	Normal
Region of Interest	<p>Set the ROI for decoding. Options include:</p> <ul style="list-style-type: none"> • Disable ROI is disabled and the entire original image is sent to the decoder. • Standard Use the aimer position to weight activity. Activity calculated on the row and the column in the middle of each cell. The ROI window may not include the aimer. • Standard, aimer centered Activity calculated on the row and the column in the middle of each cell. The ROI window will always include the aimer. • DPM, aimer centered Activity calculated on 4 rows and 2 columns in each cell. The ROI window will always include the aimer. • Kiosk/presentation application Ignore aimer position, no weight activity. Activity calculated on the row and the column in the middle of each cell. The ROI window may not include the aimer. 	Disabled

Imager Settings

You should not need to modify the Imager Settings. The **Override Recommended Values** setting is disabled by default. The recommended Imager Settings are designed to work in a wide range of environments and should only be modified if you have an advanced understanding of imagers.

Trigger Settings

Use the Trigger Settings to configure how the scan buttons work.

Trigger Settings

Setting	Description	Default
Enable Scan Trigger	Enable or Disable activating the imager by pressing the side scan buttons or the virtual Scan button in the Scan Demo app.	Enabled
Scan delay	Set the minimum amount of time in seconds before the scanner can read another bar code.	0
Decode Timeout	Set the number of seconds before the scanner automatically turns off if the scan button is pressed and nothing has successfully decoded.	20
Trigger Scan Mode	Set read behavior on scan button press. Options available: <ul style="list-style-type: none">• One Shot• Continuous• Read on release• Read on second trigger press	One Shot
Same symbol timeout	Set the minimum buffer time in seconds before the scanner reads the same bar code. This can be adjusted to prevent inadvertent scans of the same bar code if the code is left in the scan field longer than the Decode Timeout limit. The default same symbol timeout is 1000 seconds.	Disabled

Notification Settings



Use the Notification Settings to configure how your computer responds when you scan a bar code.

Notification Settings

Setting	Description	Default
Good Read Notification	Enables or disables a good read notification. The notification consists of a green blink of the Good Read LED, a short beep, and an optional short vibration.	Enabled
Bad Read Notification	Enables or disables notification of a failed scan. The notification consists of a red blink of the Good Read LED, an error beep, and an optional short vibration.	Disabled
Vibrate On Notification	Enables or disables whether the computer vibrates when there is a good or bad read.	Disabled

Add a Scan Setting Profile

To create a scan setting profile for a custom app on the computer:

1. Swipe up from the bottom of the Home screen to access all apps.
2. Tap **Settings**  > **Scanning** > **Internal Scanner**.
3. Tap  in the upper right corner of the app screen.
4. Take one of the following actions:
 - Tap the profile name field, and then add a new name.OR
 - Tap the **select an application** option, and then choose an app from the list.

The new profile appears on the Internal Scanner profile list. You can now select and modify the scan settings for the new profile.

Delete a Scan Setting Profile

1. Swipe up from the bottom of the Home screen to access all apps.
2. Tap **Settings**  > **Scanning** > **Internal Scanner**.
3. Tap and hold the profile you want to delete, and then select **Delete**.

About the Optional Digital Scan Button

By default, the imager is enabled for scanning with the left and right scan buttons configured to trigger the imager. If your application environment requires use of an on-screen scan button, enable the Digital Scan Button feature in the Settings app. Once enable, you can then modify the appearance of the on-screen Scan button and select the apps the button appears in.

Enable and Configure the Digital Scan Button

1. Swipe up from the bottom of the Home screen to access all apps.
2. Tap **Settings**  > **Digital Scan Button**.
3. Tap **Enable Digital Scan Button** to turn the feature on. A preview of the button appears at the bottom of the screen.

4. Configure the button appearance. As you adjust the settings, the preview of the button updates.
 - Tap **Select Button Size**, and then choose Small, Medium or Large.
 - Tap **Select Button Color** and then choose from seven color options. Default color is black. Tap a dot to select the color, and then select **OK** to confirm.
 - Use the slider under **Transparency Level** to adjust how transparent the button appears on the application screen.
5. Drag the preview button to the location where you want it to appear on the screen. Once you have positioned the button, tap the **Set Button Location** toggle button to lock it into position.
6. Tap **Choose Application**.
7. Check the box next to all the applications where you want the digital scan button to be available.
8. Select **OK**.
9. Tap the **Back** to return to the Settings screen.

The digital scan button appears on the screen when you open any of the apps you selected during the button setup, see example below.

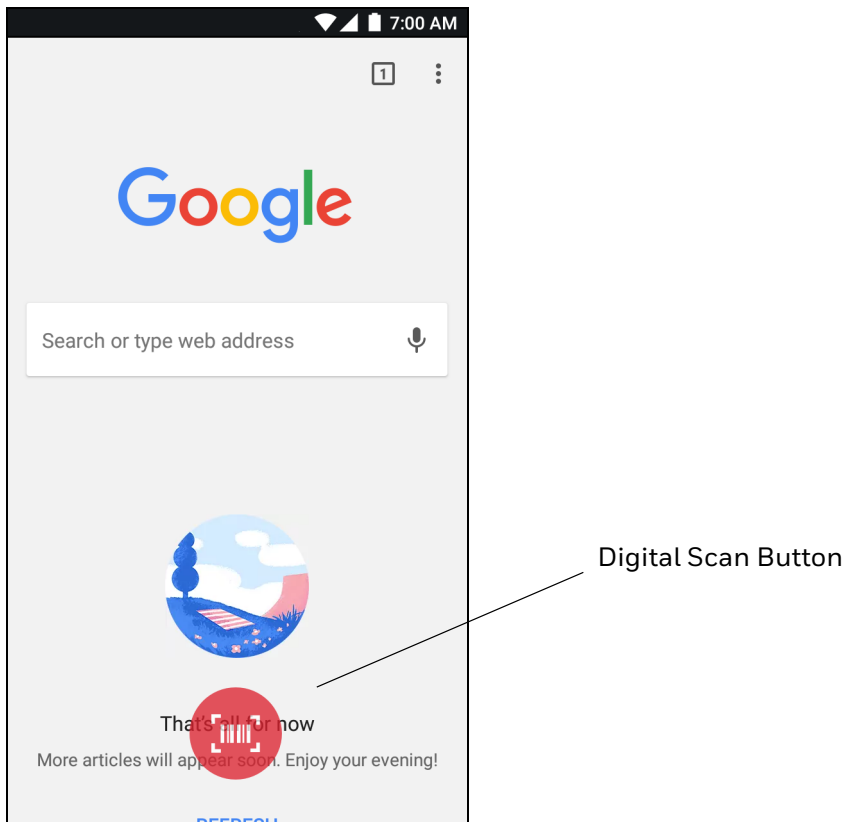

Tap and hold the button to activate the imager and scan a bar code.

Scan Bar Codes

By default, the computer imager is enabled for scanning. It supports omni-directional (360°) bar code scanning and an aiming beam is provided to help assist with targeting bar codes.

Before you start scanning bar codes, go into **Settings > Scanning > Internal Scanner** and modify the scan profile to enable only the bar code symbologies that you need. By reducing the active symbology list, you can increase scan speed.

1. Point the scanner window at the bar code. For optimum performance, avoid reflections by scanning the bar code at a slight angle.
2. Press and hold either side Scan button.
3. Center the aiming beam over the bar code. Make sure the entire bar code is inside of the illumination frame.

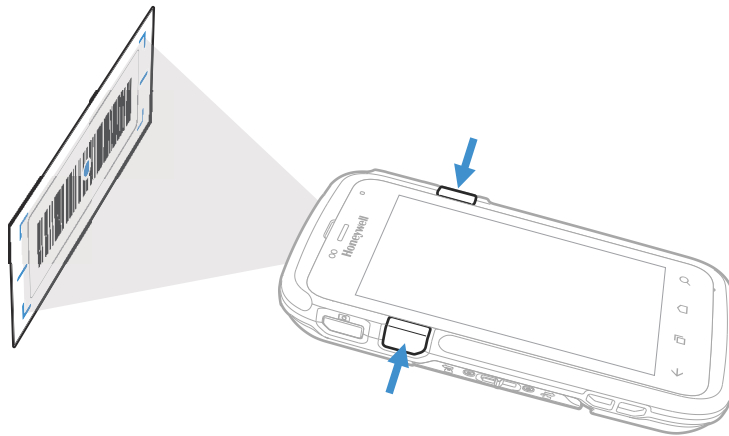

4. Release the Scan button when the computer beeps, and the Good Read LED briefly turns on. The bar code information is entered into the application in use.

Note: *Not all bar code symbologies are enabled by default. If a bar code does not scan, the correct symbology may not be enabled.*

About Scanning Configuration Bar Codes

After completing the out-of-box set up process, Provisioning mode is automatically turned off. Scanning a bar code to install applications, certificates, configuration files, and licenses on the computer is restricted unless you enable Provisioning mode in the Settings app.

To learn more [About Provisioning Mode](#), see page 70.

Use the Scan Demo App

Use the Scan Demo app to read bar codes, or to test your symbology decode settings.

1. Swipe up from the bottom of the Home screen to access all apps.
2. Tap **Demos**.
3. Swipe left or right on the screen until **Scan Demo** appears under the turntable. Tap the center of the box image to open the app.
4. Point the scanner window at the bar code.
5. Press and hold either side Scan button or tap **Scan** on the computer screen.
6. Center the aiming beam over the bar code. Make sure the entire bar code is inside of the illumination frame.
7. Release the Scan button when the computer beeps, and the Good Read LED briefly turns on. Bar code information appears on the screen.

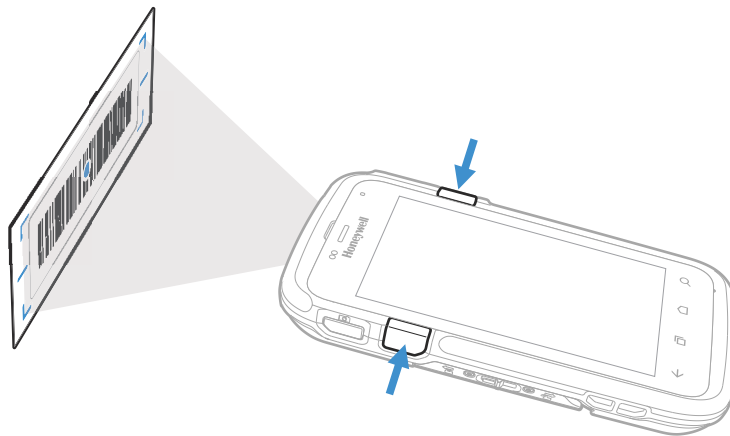

Note: In the Scan Demo app, not all bar code symbologies are enabled by default. If a bar code does not scan, the correct symbology may not be enabled.

Change the Scan Demo Symbology Settings

1. In the Scan Demo app, tap  in the upper right corner of the screen.
2. Select **Symbology Settings**.
3. Modify the symbology parameters.
 - Tap the check box next to a symbology name to enable (check mark) or disable (no check mark) decoding for that symbology.
 - Tap the symbology name to view and modify additional configuration parameters for the symbology selected.
4. Tap **Back** to return to the Scan Demo app.

Use the Imager as a Flashlight

To use the imager as a flashlight.

1. Open Quick Settings (see page [24](#)).
2. Tap the **Flashlight** icon to turn the flashlight on.
3. Select the icon again to turn the flashlight off.

You can use the phone feature to make and receive phone calls as well as transmit data through wireless wide-area networks (WWANs).

Note: *Phone features are only supported on CT60 WWAN models (CT60L1N).*

About the Phone

Phone features on the computer include a speaker and a microphone. You can also use a Bluetooth headset or hands-free kit.

On CT60 WWAN models the phone feature is enabled by default and a flexible network radio provides the ability to connect to CDMA or UMTS networks in all regions that support the technologies. The flexible network radio is a software-defined radio (SDR) that can be configured for CDMA or UMTS depending on your wireless communication needs.

CN80 WWAN mobile computers also come equipped with two micro-SIM card slots. You might use the dual SIM feature if you require two phone numbers on UMTS networks and have occasions when you want to use a different carrier or cellular plan for travel.

After you turn on the phone and activate service with your wireless carrier, you can customize the phone features and network settings in the Wireless & Networks section of the Settings app.

Note: *Both WWAN radios support Network Information and Time Zone (NITZ) messages to automatically set the system time.*

Add or Switch Between Network Carriers

The SDR radio and dual SIM card slots in the CT60 WWAN model make it easy for you to add carriers and switch between them as needed.

Use the Carrier Selection app to quickly change your WWAN radio network carrier.

1. Swipe up from the bottom of the Home screen to access all apps.
2. Tap **Carrier Selection** .
3. Select a carrier from the list, and then tap **Apply Settings**.
 - If the update is successful, the Carrier Selection screen appears and displays the updated carrier information.
 - If the update is unsuccessful, a message appears. Tap **OK** to return to the Carrier Selection screen.

Select a SIM Card Slot

CT60 WWAN mobile computers (model CT60L1N) come equipped with two SIM card slots. The dual slots give you the flexibility to install two micro-SIM cards in the computer so that you can then activate and switch between them whenever you choose. Switching is easy via the SIM selection app.

To switch between SIM Card slots:

1. Swipe up from the bottom of the Home screen to access all apps.
2. Tap **SIM Selection** .
3. Under *Select New Config*, tap the drop down arrow ▼ next to SIM slot.
4. Select either **Slot 1** for SIM 1 or **Slot 2** for SIM 2.
5. Tap the drop down arrow ▼ next to Carrier Config.
6. Select a cellular carrier.
7. Tap **Apply** and then **OK** to verify the change.
8. Tap **OK again** when the “Settings are saved” message appears.

Under *Current Config* the active SIM slot appears with the carrier setting you selected.

Activate the UMTS Phone

You use a SIM card to activate the UMTS phone on your CT60 WWAN model computer (CT60L1N). You can purchase the micro SIM card from your network provider. Dolphin CT60 WWAN models includes two SIM card slots (SIM 1 and SIM 2) for multiple network provider flexibility.

1. Select a network carrier. To learn how, see [Add or Switch Between Network Carriers](#) on page 44.
2. Activate and configure the SIM slot you are installing the card in, see [Select a SIM Card Slot](#) on page 44.
3. Press and hold the **Power** button until the options menu appears.
4. Tap **Power Off** and then **OK** to verify.
5. Disconnect one end of the hand strap from the computer.

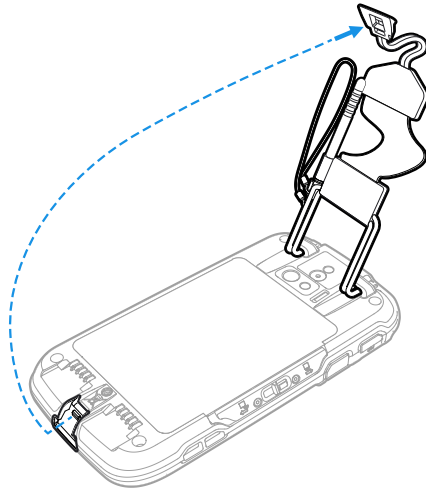

6. Press and hold down the small button on the battery latch, and then slide the latch toward the bottom of the computer to unlock the battery.

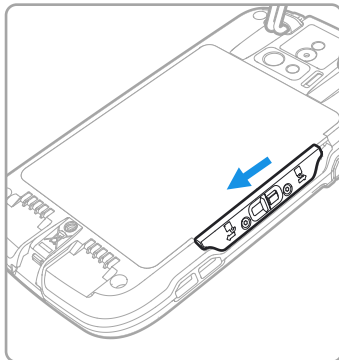

7. Lift up on the edge of the battery and remove it from the computer.

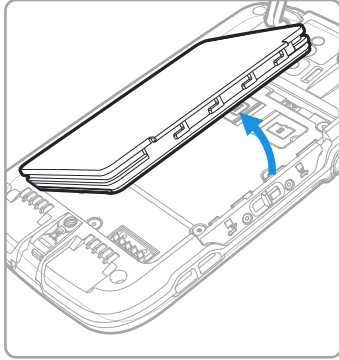

8. Lift up the edge of the SIM card access door (SIM 1 or SIM 2).

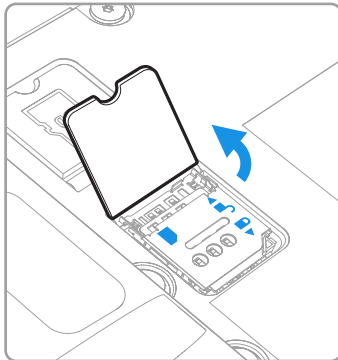

9. Press down gently and slide the card holder into the unlocked position. Lift the edge of the card holder up.

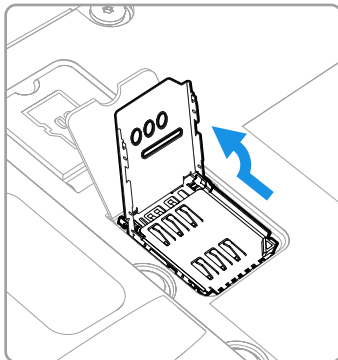

10. Insert the card in the holder with the contacts facing out.

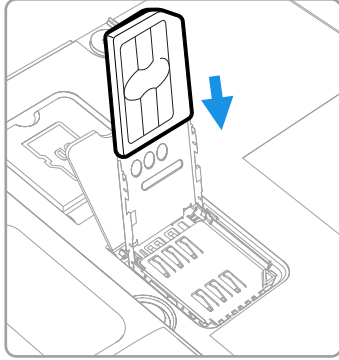

11. Close the holder with the card installed. Press down gently on the holder and slide it into the locked position.

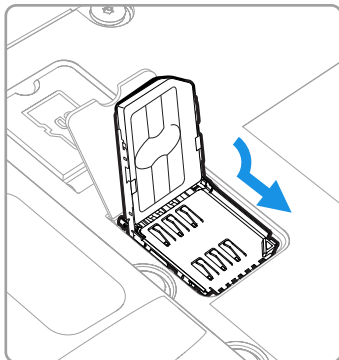

12. Close the SIM card access door.

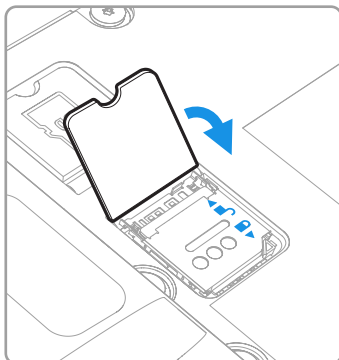

13. Install the battery and slide the battery latch toward the top of the computer to engage the lock.

14. Install the hand strap.

15. Press the **Power** button to turn on the computer.

Activate the CDMA Phone

You need to contact your wireless carrier and set up an account to activate the CDMA phone on your CT60 WWAN model computer (CT60L1N).

You also need to provide the carrier with the Mobile Equipment Identifier (MEID) for the computer. You can find the MEID:



- on a label located in the battery compartment.
- on the outside of the computer shipping box.

Note: For the CDMA phone, settings are permanently stored in the WWAN radio after activation. CDMA settings persist through an Enterprise Reset but not a Factory Reset.

The activation process is slightly different for each CDMA carrier. In general, you should contact your wireless provider to register the unique MEID number for computer and confirm the appropriate steps to take for phone activation on the providers network. Use the following steps as a guide.







1. Contact your wireless provider, verify your account is active with the carrier and give the provider the MEID number for the computer.
2. Select a network carrier. To learn how, see [Add or Switch Between Network Carriers](#) on page 44.
3. Use the activation method recommended by your provider. Methods vary by provider.

Some providers support automatic activation. This type of activation starts by simply rebooting the mobile computer. As soon as the network detects your phone, Hands-Free Activation (HFA) begins, and a series of notification messages appear. When activation is complete, a completion message appears and the WWAN radio reboots. The phone is ready to use.

Other providers require you to use the computer to make a phone call using a special number they provide. To activate the phone using this method, you would open the phone app  and select the dial pad . Enter the provider's unique activation number (e.g., *228). Tap the phone icon to initiate the call. After a short wait, a message appears on the computer, confirming either success or failure of the activation. After successful activation, the phone is ready to use.



Make a Phone Call

Once the phone is activated, you can make a phone call.

1. Tap  in the favorites tray to open the phone app.
2. Use one of the methods below to enter the telephone number you want to call.
 - Tap  and use the on-screen dialer.
 - Select a person on your saved contact list .
 - Select a favorite on your speed dial list .
 - Select a number from the recent calls list .
3. Tap call .
4. To end the call, tap .

Answer the Phone

When you receive a phone call, the Incoming Call screen opens. If the caller telephone number is available, it appears on the screen. Depending on your calling plan, you may also see a Caller ID information. All incoming calls are recorded in the Call log. If you miss a call, you receive a notification.

1. On the Incoming Call screen, tap and hold the white call icon.
2. Three icons appear:
 - To answer the call, drag the icon to .
 - To send the caller directly to voice mail, drag the icon to .
 - To send a text message back to the caller instead of answering, drag the icon to .

Switch Apps During a Phone Call

You can multitask while a phone call is in progress. For example, you can use the Calendar app to check your schedule during a call.

Note: *Depending on your WWAN connection and carrier, apps that need a data connection may be unable to access online data while the phone call is in progress. If simultaneous phone calls and data connections are not possible due to provider limitations, voice calls receive priority. Check with your provider for more information.*



1. During a phone call the screen goes dark. Take the phone away from your ear to wake the screen. Tap the **Home** button.
2. Select another app (e.g., Calendar, Contacts). The phone icon appears in the status bar at the top of the screen while the call is connected.
3. To return to the call screen, swipe down from the top of the screen and select ongoing call notification or select Hang up if you want to end the call.

Make an Emergency Phone Call

You can use the phone to make an emergency phone call even if the SIM card is missing from your UMTS phone or if you do not have a valid CDMA account. The phone shows no service but the call still goes through if you dial certain emergency numbers (e.g., 112, 911, 000, 08, 118, 119, and 999).

Configure Phone Settings

You can customize settings for the phone, including the ringtone, voicemail options, keypad tones, Internet call settings, and other options.

1. Open the phone app .
2. Tap  next to the microphone icon at the top of the screen.
3. Select **Settings**. The Call settings menu appears.
4. Change phone settings as necessary.

Note: *Available settings vary depending on your cellular carrier and phone plan.*

USE THE CAMERA

Use this chapter to learn how to take pictures and record videos with the color camera.

About the Color Camera

The CT60 comes equipped with a 13-megapixel color camera, 4K video with image stabilization, and advanced software features for enhanced exposure control for taking pictures and videos. The camera lens and flash are located on the back of the computer.

Use the Photos app  to view photos and videos stored on the CT60.

By default the photos and videos captured with the Camera app are saved on the computer under Internal shared storage\DCIM\Camera.

How to Zoom

The camera zoom is controlled using a pinching motion on the touch screen. Place two fingers on the screen at the same time, and then:

- spread them apart to zoom in (enlarge and object).
- pinch them together to zoom out.

Take a Photo

1. Tap the **Snapdragon™ Camera** icon  in the favorites tray or press the **Camera** button on the left side of the computer.
2. Using the screen as a viewfinder, move the computer until you see the image you want to capture. The camera lens is located on the back of the computer.

3. The camera automatically adjusts the focus but you can tap the screen to modify the focal point. By default, the camera senses the lighting in the environment and turns the flash on, if needed.
4. Press the Camera button or tap  to take a photo.
 - To view the picture, tap the preview near the bottom of the screen.
 - To return to the Camera app, tap the **Back** navigation button.

Change Camera Settings

You can change the camera settings for best results when taking pictures. The camera settings are adjustable from within the Snapdragon™ Camera app.



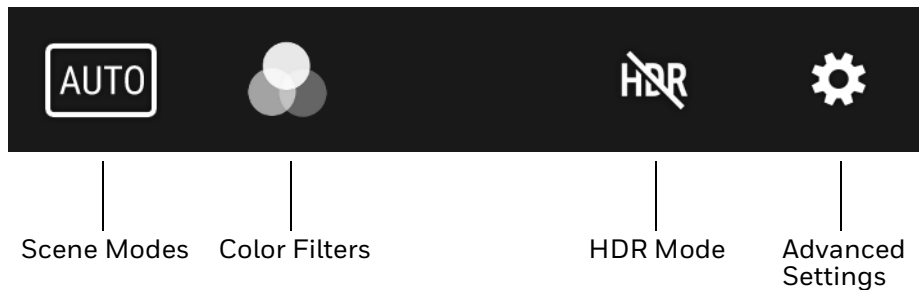

1. Open the **Snapdragon Camera** app .
2. At the top of the screen, select any of the following to adjust the settings.



- **Scene Modes**
Use preset setting profiles for best picture quality. Options include: Automatic, High Dynamic Range (HDR), OptiZoom, Portrait, Landscape, Sports
- **Color Filters**
Stylize your pictures by applying a filter. Options include: None, Mono, Sepia, Negative, Solarize, Posterize, Aqua, Emboss, Sketch, Neon
- **HDR Mode**
Tap to quickly toggle HDR mode on or off. When enabled, the computer automatically captures multiple photos and combines them into one photo creating the best quality image possible.
- **Advanced Settings**
Manually set advanced features. Options include: Flash, GPS location, Picture size, Picture quality, Countdown timer, Storage, Continuous shot, Face detection, ISO, Exposure, White balance, Chroma flash, Readeye reduction, and Shutter sound.



Record a Video

This section explains how to record video with the camera in the computer.

1. Tap the **Snapdragon Camera** icon  in the favorites tray or press the **Camera** button on the left side of the computer.
2. Tap mode selection  in the bottom right corner of the app.
3. Tap  to select video.
4. Tap  to begin recording video. To zoom in or out, pinch or spread your fingers apart.
5. When you are done recording, tap .

Change Video Settings

You can change the video settings for best results when recording video.

1. Open the **Snapdragon Camera** app .
2. Tap  to select video.
3. At the top of the screen, select any of the following to adjust the settings.

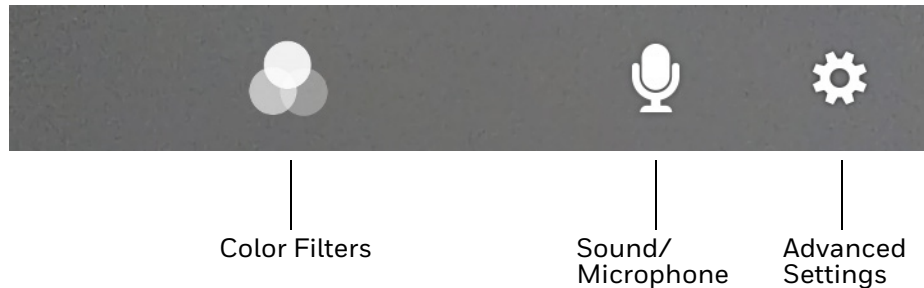

- **Color Filter**
Stylize your video by applying a filter. Options include: None, Mono, Sepia, Negative, Solarize, Posterize, Aqua, Emboss, Sketch, Neon.
- **Sound/Microphone**
Tap to quickly toggle sound recording on or off.
- **Advanced Settings**
Manually set advanced features. Options include: Flash, Video quality, Video duration, GPS location, Storage, White balance and Image stabilization.

CONFIGURE THE COMPUTER

Use this chapter to learn about the available methods for configuring your mobile computer. You can also use this chapter to learn how to configure network communications and wireless security.

How to Configure the Computer

You can configure many parameters on the computer such as the bar code symbologies it decodes or the network settings. The values you set for these parameters determine how the computer operates.

You configure the computer using the Settings app.

Start the Settings App

The Settings app is available from the all apps menu and the notification panel.

- Swipe up from the bottom of the Home screen to access all apps, and then tap Settings .

OR

- Swipe down from the top of the Home screen, and then select  in the status bar.



Note: To view a simplified settings menu without descriptions, swipe right from the left edge of the Settings screen.

About the Structure of the Settings App



Use this section to learn about the structure of the Settings app so you can find parameters quickly.

Note: *The Settings app varies by computer model and OS version. Your computer may not include all the features outlined in this section.*

When you open the Settings app, suggestions may appear at the top of the list.



- Tap  or  to expand or collapse the suggestion list.
- Tap a suggestion to open the settings screen or app relevant to the suggestion.
- Tap the , and then **Remove** to dismiss the suggestion.



Wireless & networks

Setting	Description
WLAN	<ul style="list-style-type: none">• Turn WLAN radio on or off.• Lists available Wi-Fi networks in range and the connection status when the radio is turned on.• Add a network Wi-Fi connection.• Tap  to view saved networks, turn public network notifications on or off, modify WLAN radio sleep settings, view MAC and IP address information.• Tap  to access advanced Wi-Fi options.
Bluetooth	<ul style="list-style-type: none">• Turn the Bluetooth radio on or off.• Lists Bluetooth enabled devices in range when the radio is turned on.• Connect to a Bluetooth Device.• Tap  to rename the computer and show received files.
Ethernet	<ul style="list-style-type: none">• Turn Ethernet connection on and off.• Configure Ethernet connections and set up proxy settings when Ethernet setting is turned on.
Data usage	<ul style="list-style-type: none">• Manage mobile/cellular data usage.• View mobile or Wi-Fi data use statistics for the current data use cycle.• Turn the Data saver feature on or off.• Turn network restrictions for metered WLAN networks on or off.
More ...	
Airplane	Turn Airplane mode on or off.

Setting	Description
NFC	<ul style="list-style-type: none"> Turn Near Field Communication (NFC) on or off. When the NFC radio is enabled, data exchanges are allowed when the computer touches another NFC enabled device. Turn the Android Beam feature on or off. When NFC is enabled, this feature is accessible. You can beam app content to another NFC capable device by holding the devices close together. The app determines what content is transmitted to the other device.
Tethering & portable hotspot	<ul style="list-style-type: none"> Enable or disable USB tethering or Bluetooth tethering for sharing mobile data connections. Enable or Disable using the computer as a portable Wi-Fi hotspot. Configure Wi-Fi hotspot.
VPN	Set the password parameters for a virtual private network (VPN) connection.
Cellular networks	Modify mobile network settings, including enabling data access and roaming over mobile networks, selecting access points and network operators, or selecting only 2G networks (to save battery life).
Mobile plan	Provides information on your cell phone plan.
Network settings reset	Use to reset all network settings including Wi-Fi, Bluetooth, and cellular data.

Device

Setting	Description
Display	<p>Adjust display settings.</p> <ul style="list-style-type: none"> Turn Adaptive brightness on or off or set the Brightness level manually if Adaptive brightness is turned off. Set the wallpaper and set screen saver. Set Sleep mode timeout length (minutes). Set screen font size and display size. Turn Ambient display on or off. Turn screen auto-rotation on or off.
Notifications	<ul style="list-style-type: none"> Tap an app to set the notification settings for only that app. Tap , and then On the lock screen to set what notifications appear on the lock screen (i.e., Don't show notifications at all, Show all notification content, or Hide sensitive notification content) Tap , and then Reset app preferences to restore all app notification defaults.

Setting	Description
Sound	<ul style="list-style-type: none"> Adjust volume levels for media, alarms, and rings (phone calls and notifications). Configure the Do not disturb feature. Set the phone ringtone and turn vibration during call ringing on or off. Set what emergency information you want to receive and how you want to receive it. Other Sounds: Turn sounds on or off for touch, charging, screen lock, and vibration on tap.
Apps	<ul style="list-style-type: none"> View a list of all apps installed on the computer or system services running. Tap , app configuration (e.g., permissions, links, defaults, power setting). Tap , to show or hide system services or to reset app preferences.
Storage	Shows the remaining amount of storage in IPSM card and Internal shared storage. If a microSD card is installed, storage amounts appear for the card.
Battery	<ul style="list-style-type: none"> View battery usage data and the current battery state. Access Battery Saver and Battery Optimization features.
Memory	View statistics about the average memory use and memory used by apps.
Users	<ul style="list-style-type: none"> Modify the owner profile name and add profiles other people who use the computer. Activate a different user profile. Tap Emergency information to enter emergency information for the active user profile. The information you enter may be used by first responders in an emergency. Anyone can read the information from the emergency dialer without unlocking the computer.

Personal

Setting	Description
Location	<ul style="list-style-type: none"> Turn location services (Google and GPS satellite data) on or off. Set location mode accuracy. View location request history. Tap . Turn Wi-Fi and/or Bluetooth scanning on or off. When enabled system apps and services are allowed to detect Wi-Fi networks or Bluetooth devices at any time to improve location services.
Security	<ul style="list-style-type: none"> Set device security settings (e.g., screen lock). View phone encryption status. Manage administrator privileges and enable/disable installation of apps from unknown sources. Manage credentials and trusted agents. Turn screen pinning on or off. View app usage access.

Setting	Description
Accounts	Add and manage Corporate or Email account on the computer. Tap  , and then turn auto-sync on or off for accounts.
Google	Set up and manage your Google accounts and services.
Language & input	<ul style="list-style-type: none"> Set the active language. Configure auto-typing features such as capitalization, punctuation, spell check, and the personal dictionary. Set and manage Keyboard and input methods (Virtual and Physical). Set text-to-speech output. Adjusts the pointer speed.
Backup & reset	<ul style="list-style-type: none"> Set data backup and restore options. Perform an Enterprise Reset. To learn more, see About an Enterprise Data Reset on page 77. Perform a Factory Reset. To learn more, see About a Factory Data Reset on page 78.

Honeywell Settings

Setting	Description
Key Remap	Change (remap) a button or key function. To learn more, see Remap a Button on page 23.
Key WakeUp	Set the buttons you want to use to wake the computer from sleep mode. Options include: Camera, Left Scan, Right Scan, Volume Up, Volume Down. By default the Left and Right scan buttons are enabled for wake up.
Battery Monitor	View the battery charge status and battery information such as, overall battery health, internal temperature, and serial number.
Battery Maximizer	<p>Create, enable or disable a battery optimization profile that implements a group of settings to conserve power. Options include:</p> <ul style="list-style-type: none"> None When selected, no battery optimization profile is active. Energy Saver This pre-defined profile implements UI settings that optimize battery conservation. Vibration is turned off, audio volume is lowered, the display brightness is reduced and the backlight timeout limit is adjusted to conserve power. Add a Custom Profile Select to create a custom battery profile that balances your application needs with energy saving settings. You can turn location services on or off, configure sound and vibration options, modify brightness and timeout display options, turn UI transition animations on or off and background services on or off. Restore settings affected by Battery Maximizer Select to reset the settings changed by the Battery Maximizer feature back to their factory default values.
Smart sensors	Configures the integrated motion detection sensors for advanced power management. Options include: Keep awake on motion, Wake on motion, Face down suspend.

Setting	Description
Battery LED	Configures the battery LED behavior. To learn more see, Change the Battery Status LED Behavior on page 7.
HXLogger	<p>The HXLogger is an advanced diagnostic log service that provides a basic log service, plug-ins for modified log services, and a log manager.</p> <ul style="list-style-type: none"> • Tap HXLogger to turn the basic log service on or off. When enabled the service records app and system diagnostic troubleshooting information into four basic log files: main log file, radio log, event log, and kernel log. • Tap Plugin to view and enable additional log services and custom plug-ins. • Tap Manager, to change the default log path, delete logs or upload logs for technical support troubleshooting.
Scanning	Configure the computer imager. To learn more, see Change the Scanner Settings on page 32.
BLE Beacon	Turn the computer's Bluetooth Low Energy (BLE) beacon on or off. When enabled the computer emits a repetitive signal that can be used for location and proximity tracking and transferring short bursts of very small amounts of data. You can configure the beacon to turn off when the screen turns off and the set the advertising interval (i.e. Fast, Medium, Slow) of the beacon.
Provisioning Mode	Enable or disable unrestricted installation of applications, certificates, configuration files, and licenses. Provisioning mode is turned off by default. To learn more About Provisioning Mode , see page 70.
Staging Hub Agent	Use this agent and settings to connect the computer to the Honeywell Staging Hub Foundation software platform; a centralized software platform IT integrators and administrators can use as a solution for managing, monitoring and deploying Honeywell devices in a connected workspace environment.
Web Applications	Enables access for the Honeywell Mobility SDK for Web apps and lets you set a port.
Touch Screen Profiles	Optimize screen interactions by selecting a touch screen profile designed specifically for your use case. To learn more, see page 11 .
Digital Scan Button	Enable and configure the optional digital scan button. To learn more, see About the Optional Digital Scan Button on page 37.

System

Setting	Description
Date & time	Configure all date and time settings
Scheduled power on and off	Configure the computer to automatically turn on and/or off. Select time and event frequency.
Accessibility	Set accessibility levels, such as larger display text and enabling text-to-speech output.
Printing	Configure print options.
Developer options	<p>Enable developer-specific options such as USB debugging and SD card protection.</p> <p>This option only appears under System settings if you enable the feature. To learn more, see Unlock Developer Options on page 29.</p>

Setting	Description
About phone	View device-specific information including the model number, phone number, operating system version, software patch version, radio versions, build number and legal information.

About Network Communications



You can easily add the mobile computer to your wireless or wired data collection network. Connect the CT60 your computer using:

- 802.11 a/b/g/n/ac radio communications.
- Ethernet communications.
- Bluetooth communications.
- USB and serial communications.

Connect to a Wi-Fi Network

The computer contains an 802.11 a/b/g/n/ac radio to transfer data using wireless communications. Before you connect to a Wi-Fi network, you need to know about your network security protocol and its required credentials.

By default, the 802.11 radio is disabled.

1. Swipe up from the bottom of the Home screen to access all apps.
2. Tap Settings  > **WLAN**.
3. Tap **Off**  to toggle Wi-Fi radio **On** . A list of discovered networks appears.
4. On the list, tap a network name to initiate a connection.

To add a network if it does not appear on the list:

- a. Navigate to the end of the discovered network list, and then tap **Add network**.
 - b. Type the Wi-Fi network name (SSID).
 - c. Choose a security protocol and add any required information.
 - d. Tap **Save**.
5. Enter any required information if the network is secured (e.g., password, key or certificate name).
 6. Tap **Connect**.

Once you connect to a saved Wi-Fi network:

- Tap the network name on the list to view details (e.g., status, signal strength, speed, frequency, security type). Select **Cancel** to close details screen.
- The computer automatically connects to the same network when the network is in range and the WLAN radio is turned on.

- To remove a network from your saved list, tap and hold the network name and select **Forget network**. You can do this for networks you no longer use.
- To modify a network from your saved list, tap and hold the network name and select **Modify network**. You can do this if you changed your network password.
- To view a list of only your saved networks, tap , and then select **Saved networks**.

Configure Proxy Settings for a Wi-Fi Network



If you need to connect to network resources through a proxy server, you can configure settings for the proxy server for each Wi-Fi network you add. By default, the Wi-Fi networks you add are not configured to connect through a proxy server.

Note: Proxy settings apply only to the Wi-Fi network you modify. You must change proxy settings for each network requiring a proxy server.

1. Swipe up from the bottom of the Home screen to access all apps.
2. Tap Settings  > **WLAN**. The list of available Wi-Fi networks appears.
3. Tap and hold the name of a connected network, and then tap **Modify network**.
4. Tap **Advanced options**.
5. Under Proxy, tap **None** to open menu, and then select **Manual**.
6. Enter the proxy settings for the network.
7. Tap **Save**.

Disable Wi-Fi Notifications and Set WLAN Radio Sleep Parameter

By default, when Wi-Fi is enabled, you receive notifications in the Status bar when the computer discovers a wireless network. You can disable these notifications.

1. Swipe up from the bottom of the Home screen to access all apps.
2. Tap Settings  > **WLAN**. Verify the WLAN radio is turned on.
3. Tap . The Configure Wi-Fi menu appears.
4. Select a setting to modify:
 - Tap the **Network notification** to toggle the setting on or off.
 - Tap **Keep WLAN on during sleep**, and then select either **Always**, **Only when plugged in** or **Never**.

Connect to an Ethernet Network

To connect the computer to an Ethernet network, you need an eHomeBase or NetBase.

1. Make sure the base is connected to your Ethernet network.
2. Place the computer in the base.
3. Swipe up from the bottom of the Home screen to access all apps.
4. Tap Settings  > **Ethernet**. The Ethernet setting is turned **On** by default.
5. Tap **Ethernet**.

The Ethernet connection screen shows the current Ethernet connection. By default, the computer assumes a DHCP connection, and that your network has assigned an IP address automatically. If DHCP is working, the Ethernet base should indicate that communication with the network is occurring.

6. (Optional) To assign a static IP address.
 - a. Tap **DHCP** and then select **Static** from the list.
 - b. Enter the required network information, and then tap **Apply**.
7. Tap **Save**.

How to Connect to Virtual Private Networks

The computer supports connecting to virtual private networks (VPNs). This section describes how to add and connect to VPNs. To configure VPN access, you must obtain details from your network administrator. You view and change VPN settings in the Settings app.

Note: Before you can add or connect to a VPN network, you must enable a screen lock method.

Add a VPN

Before you can connect to a VPN, you must create a VPN profile.

1. Swipe up from the bottom of the Home screen to access all apps.
2. Tap **Settings**  > **More** > **VPN**.
3. Tap **+** to add a VPN new profile.
4. Enter the required information for the VPN connection. If needed, swipe up on the screen to access all the required information fields.
5. Tap **Save**. The VPN name appears in the VPN list.

Connect to a VPN



Once a VPN profile is created, you can connect to the VPN at any time.

1. Swipe up from the bottom of the Home screen to access all apps.
2. Tap **Settings**  > **More** > **VPN**.
3. Tap the name of the VPN in the list.
4. Enter any necessary credentials when prompted.
5. Tap **Connect**.

A  appears in the status bar and a notification is received. To disconnect from the VPN, tap the notification.

Edit VPN Information

Editing an existing VPN profile be done from the VPN screen.

1. Swipe up from the bottom of the Home screen to access all apps.
2. Tap **Settings**  > **More** > **VPN**.
3. Tap and hold the name of the VPN in the list.
4. Tap  to the right of the VPN profile you want to edit.
5. Edit the VPN settings as necessary.
6. When you are done, tap **Save**.

About Wireless Security

The computer provides these security solutions for your wireless network:

- Wi-Fi Protected Access 2 (WPA2™)
- Wi-Fi Protected Access (WPA)
- 802.1x

Honeywell recommends WPA2 security with PSK (Personal) or 802.1x (Enterprise) key management.

Before you set security, you need to enable the radio, set the date, and set the SSID on your computer. To use 802.1x security, you need to load a root certificate on your computer. To use transport layer security (TLS) with 802.1x security, you also need to load a user certificate.

Use the Settings app to access and configure all wireless security settings.

About Certificates

You can use digital certificates to identify the computer for network access or authentication to servers. To use a certificate to identify your device, you must install it in the trusted credential storage on the computer.

Android supports DER-encoded X.509 certificates saved in files with a .crt or .cer file extension. To install a valid certificate with a .der or other extension, you must change the extension to .crt or .cer to install it.

Android also supports X.509 certificates saved in PKCS#12 key store files with a .p12 or .pfx extension. To install a valid key store file with another extension, you must change the extension to .p12 or .pfx to install it. When you install a certificate from a PKCS#12 key store, Android also installs any accompanying private key or certificate authority certificates.

Load a Certificate

To use a certificate, you must install it in the trusted credential storage on the computer.

Note: *Apps such as email and browsers that support certificates allow you to install certificates directly from within the app. For more information, see the help that comes with the app.*

1. Copy the certificate or key store from your PC to the mobile computer.
2. Swipe up from the bottom of the Home screen to access all apps.
3. Tap **Settings**  > **Security**.
4. Tap **Install from storage**. Navigate to the location where you saved the certificate or key store.
5. Tap the certificate or key store to install it. If prompted, enter the key store password and tap **OK**.
6. Select **VPN and apps** or **Wi-Fi**.
7. Enter a name for the certificate and tap **OK**.

Disable or Remove Certificates

If a user or system certificate is compromised, or your organization chooses not to trust it, you can disable or remove the certificate.

1. Swipe up from the bottom of the Home screen to access all apps.
2. Tap **Settings**  > **Security** > **Trusted credentials**.

The trusted credentials screen has two tabs:

- **System** shows Certificate Authorities (CA) certificates permanently installed on the computer. They can only be disabled.
 - **User** shows CA certificates you have installed yourself. You can remove these certificates.
3. Tap the name of the certificate to you want to disable or remove. The Security certificate screen appears.

4. Scroll to the bottom of the screen and tap **Disable** (for System certificates) or **Remove** (for User certificates).
5. Tap **OK**.



Note: You can enable a disabled System certificate but if you remove a User certificate, you must install it again to enable it.

About Bluetooth Communications

Your mobile computer is equipped to communicate with other devices using Bluetooth technology. The Bluetooth radio must be turned on to discover, pair and connect to other Bluetooth devices. System bar icons indicate Bluetooth radio status.

Connect a Bluetooth Device

To connect to a Bluetooth device, you must turn on the Bluetooth radio and then select the device from a list of discovered devices.

1. Swipe up from the bottom of the Home screen to access all apps.
2. Tap **Settings**  > **Bluetooth**.
3. If necessary, tap **Off**  to toggle the Bluetooth radio **On** . A list of available Bluetooth devices appears.
4. Select a device on the list to initiate a pairing request.
5. When the pairing request message appears:
 - Verify the pairing PIN is the same on both device, and then tap **Pair**.OR
 - If the pairing request requires a PIN, enter the **PIN**, and then tap **Pair**.

When the device is successfully paired with the computer, the device name appears under Paired devices.

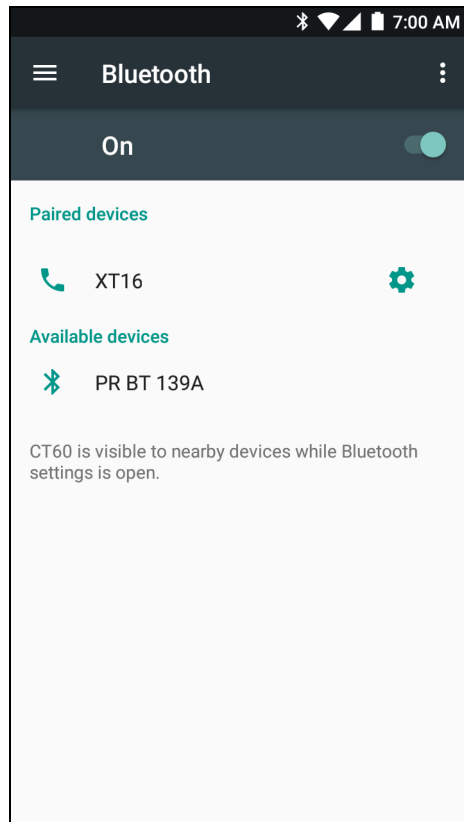



6. (Optional) Once paired to a device, you can connect manually to the device. Tap the device under Paired devices. The word “Connected” appears under the paired device name.

The status icon changes from  to .

- To disconnect a paired device, tap the name of the paired device and then tap **OK** when the “Disconnect?” screen appears.

Rename the Computer and View File History



You can change the name of the computer to make it easier to identify when pairing with other Bluetooth enabled devices and view statistics about received files.

1. Swipe up from the bottom of the Home screen to access all apps.
2. Tap **Settings**  > **Bluetooth**.
3. Tap , and then select a one of the following options:
 - Tap **Rename this device** to change the device name. Type the new name and then tap **Rename**.

- Tap **Show received files** to view statistics on the received files.

Rename or Unpair a Paired Device

You can rename a paired device to make it easier to identify on the list or unpair the device to remove it from the paired list.

1. Swipe up from the bottom of the Home screen to access all apps.
2. Tap **Settings**  > **Bluetooth**.
3. Tap  next to the paired device.
4. Take one of the following actions:
 - To rename the device, type the new name, and then tap **OK**.
 - To allow **Internet connection sharing** or **Contact Sharing**, tap the check box next to the setting.
 - To unpair the device, tap **Forget**.

About Serial and USB Communications

You can use these Dolphin CT50 series accessories to transmit data to and receive data from another device through serial or USB communications:

- Vehicle dock
- HomeBase
- Ethernet HomeBase
- USB snap-on adapter
- RS-232 DEX adapter

For information on these accessories, contact your local sales representative.

USB Troubleshooting

- If you have a problem with your workstation computer recognizing the USB device, try downloading and installing the Honeywell-aidc-usb-driver. The driver is part of the Honeywell_Mobility SDK_Android software.zip file. To learn where to get the software, see [Developer Information](#) on page 70.
- Check to make sure you have enabled the USB for file transfer. To learn more, see [Configure USB Connection and Transfer Files](#) on page 18.

How to Share Your Mobile Data Connection

You can share the mobile data connection through USB tethering or Bluetooth tethering. You can also use the computer as a Wi-Fi hotspot to share the connection with other devices.

Share the Data Connection Through USB or Bluetooth

You can share your data connection with another device through tethering. After you connect the computer to another device through a USB connection, you can share the mobile computer's data connection through USB tethering. Or, if the device is Bluetooth-capable, you can configure the mobile computer to share the data connection with the device through Bluetooth tethering.

1. Connect the mobile computer to another device through a USB connection using a Dolphin CT50 series accessory.
2. Swipe up from the bottom of the Home screen to access all apps.
3. Tap **Settings**  > **Bluetooth** > **More**.
4. Tap **Tethering & portable hotspot**.
5. Tap the type of tether to initiate:
 - Tap **USB tethering** to enable the connection.
 - Tap **Bluetooth tethering** to enable the connection.
The device is now sharing the computer data connection.
6. To stop sharing the connection, disconnect the USB cable, or tap **USB tethering** or **Bluetooth tethering** again to turn off the feature.

About Near Field Communication (NFC)

NFC technology provides the ability for short-range, wireless data transfer between the CT60 and NFC tags or other NFC enabled devices placed in close proximity to the back of the computer. All CT60 mobile computers support the following modes of operation:

- **NFC tag reader/writer mode:** The computer reads and/or writes digital information from or to an NFC tag.
- **Peer-to-Peer (P2P) mode:** The computer uses Android Beam and/or Bluetooth technology to transfer screen content (e.g., a picture, contact information, Web page URL, or file) between NFC enabled devices.
- **NFC card emulation mode:** The computer emulates an NFC card (smart card) that an external card reader can access. You can download and install apps for card emulation mode from the Google Play™ store. Some examples include digital wallets (e-wallets) offered by your bank or credit card company and Google Pay™. The app you install determines the type of emulation mode used:

Card Emulation with a Secure Element or Host-based Card Emulation. Secure element use is common for financial transactions that require a high level of security in order to provide a secure memory and execution environment for running custom smart card applets and storing your personal information (e.g., account information and credentials).

Note: *When using a Universal Integrated Circuit (UICC) card for NFC Secure Element NFC link encryption, install the card in SIM slot 1.*

Developer Information

To download the Honeywell Mobility SDK for Android and EZConfig for Mobility:

1. Go to www.honeywellaidc.com.
2. Select **Get Resources > Software**.
3. Click on the *Technical Support Downloads Portal* link, <https://hsmftp.honeywell.com>.
4. Create an account if you have not already created one. You must login to download the software.
5. Install the *Honeywell Download Manager* tool on your workstation (e.g., laptop or desktop computer) prior to trying to download any files.
6. Navigate to the software:
 - *Honeywell Mobility SDK for Android*
Click on **Software > Software and Tools > Developer Library > SDKs for Android**.
 - *EZConfig for Mobility*
Click on **Software > Software and Tools > EZConfig for Mobility**.
7. Select **Download** next to the software zip file.

About Provisioning Mode

Once you complete the out-of-box initial setup process, Provisioning mode is automatically turned off to improve device security against unwanted modifications to the system.

When Provisioning mode is turned off (disabled):

- Configuration bar codes do not scan and process.
- \honeywell\autoinstall folders are inaccessible.

Note: *To learn more about network and security for Honeywell mobile computers with Android operating systems, go to www.honeywellaidc.com.*

Enable or Disable Provisioning Mode

1. Swipe up from the bottom of the Home screen to access all apps.
2. Tap **Settings**  > **Provisioning mode** under *Honeywell Settings*.
3. Tap the button to toggle the provisioning On or Off.

MANAGE AND MAINTAIN THE COMPUTER

Use this chapter to understand how to upgrade software, reset and maintain the computer.

About Software Updates

Honeywell provides patches and security updates for existing software products at no additional charge. Software upgrades (from one major version to another) may involve additional charges. Some licensed software that Honeywell distributes requires user registration and log in before the software can be downloaded.

Support for Honeywell Safety and Productivity Solutions products is available online through the [Technical Support Portal](#).

Software downloads can be accessed through the [Technical Support Downloads Portal](#).



1. Go to www.honeywellaidc.com.
2. Select **Get Resources** > **Software**.
3. Click on the *Technical Support Downloads Portal* link, <https://hsmftp.honeywell.com>.
4. Create an account if you have not already created one. You must login to download the software.
5. Install the *Honeywell Download Manager* tool on your workstation (e.g., laptop or desktop computer) prior to trying to download any files.
6. Locate the app or upgrade you want to download in the Software directory tree.
7. Select **Download**. Follow the prompts to download the file.

About Transferring Files via USB Connection

If you plan on using a USB connection to transfer the upgrade files to the mobile computer, make sure you set the USB connection to allow file transfers. To learn more, see [Configure USB Connection and Transfer Files](#) on page 18.

Install Software Updates with AutoInstall

Important: *The Dolphin CT60 must have power for the entire length of the upgrade process or it could become unstable. Do not attempt to remove the battery during the process.*

1. Swipe up from the bottom of the Home screen to access all apps.
2. Tap **Settings**  > **Provisioning mode** under *Honeywell Settings*.
3. Tap the toggle button to turn Provisioning mode **On**.
4. Save the upgrade file (*.zip or *.apk) in one of the following folders on the CT60 mobile computer:
 - **Internal shared storage\honeywell\autoinstall**
Software upgrades saved to this folder for installation, do not persist when a Factory Reset or Enterprise data reset is performed.
 - **IPSM card\honeywell\autoinstall**
Software upgrades saved to this folder, do not persist when a Factory Reset is performed. However, the upgrade does persist if an Enterprise data reset is performed.
5. Swipe up from the bottom of the Home screen to access all apps.
6. Tap **AutoInstall Settings**  and verify **Autoinstall** is enabled .
7. Tap **Packages Update** from the AutoInstall Settings screen.



The computer automatically initiates a reboot and installs the software upgrade. The system update screen appears during the upgrade process. When the update is finished, the lock screen appears.
8. Once installation is complete, turn Provisioning mode Off.

Note: *Some updates do not require the computer to reboot before installation.*

Optional microSD Card Method

The CT60 comes equipped with a microSD card socket. You can install an upgrade from a microSD card you insert in the computer.

Important: *The Dolphin CT60 must have power for the entire length of the upgrade process or it could become unstable. Do not attempt to remove the battery during the process.*

1. On the CT60, swipe up from the bottom of the Home screen to access all apps.
2. Tap **Settings**  > **Provisioning mode** under *Honeywell Settings*.
3. Tap the toggle button to turn Provisioning mode **On**.
4. Tap **AutoInstall Settings** . Verify **Autoinstall** is enabled .
5. Press and hold the **Power** button, and then tap **Power off**.

6. On your workstation (e.g., laptop, desktop computer), format the microSD card and create a **\honeywell\autoinstall** folder on the root of the card.
7. Save the upgrade file in the **autoinstall** folder.
8. Install the microSD card in the CT60, and then press the **Power** button.

The computer automatically runs the upgrade found in the autoinstall folder on the card. The system update screen appears during the upgrade process. When the upgrade is finished, the lock screen appears.

9. Once installation is complete, turn Provisioning mode Off.

About the Honeywell Upgrader

Use the Honeywell Upgrader app (HUpgrader) to check for and install OTA updates, and view the current OTA version installed on the computer.

Install OTA Updates

To use the HUpgrader to install an OTA update file downloaded from the [Technical Support Downloads Portal](#):

1. Save the OTA file (*.zip) in the following folder on the CT60 computer:
 - **Internal shared storage\Download**
2. Tap **HUpgrader**  to open the Honeywell Updater app.

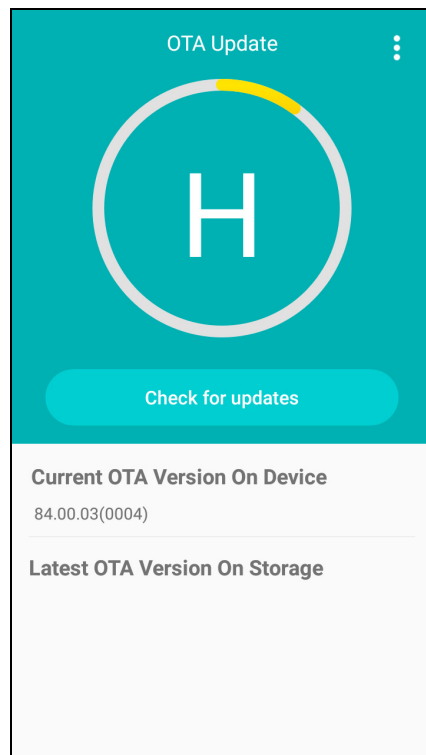

3. Tap **⋮**, and then tap **Select OTA from storage**.
4. Select the storage location (i.e., Internal Storage) where you saved the file.
5. Tap the OTA update file. The computer examines the file, and then starts the installation.

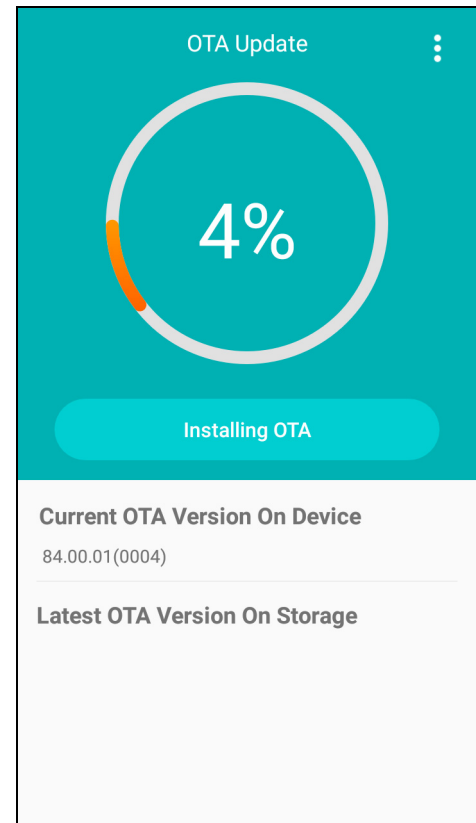
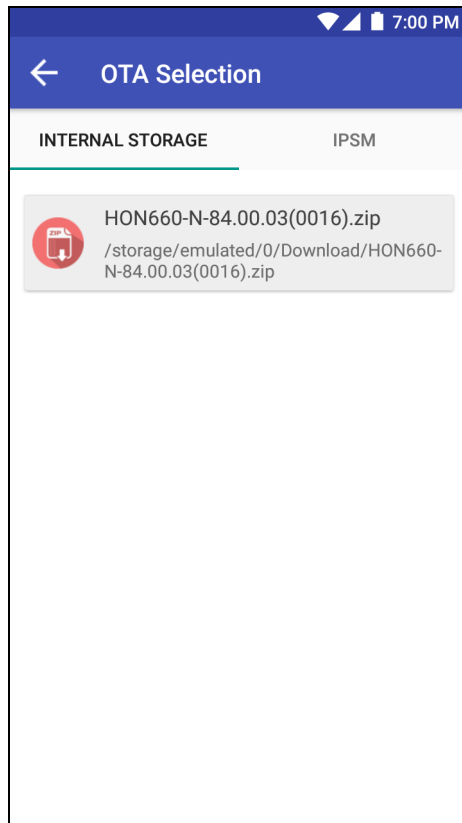

6. Once the installation is complete (100%), select **OK** when prompted to **Reboot** the computer. The computer reboots and finishes the update.

Reboot (Restart) the Computer

You may need to reboot the computer to correct conditions where an application stops responding to the system.

1. Save your files and close any open applications.
2. Press and hold the **Power** button until the options screen appears.
3. Tap **Reboot**.
4. Tap **OK** to confirm Reboot. The computer reboots.

If the touch panel display is unresponsive:

- Press and hold the **Power** button for approximately 8 seconds until the computer reboots.

About an Enterprise Data Reset

You can perform an Enterprise data reset if a Reboot did not improve the condition and all other troubleshooting methods have not resolved the issue. This method provides a clean configuration for troubleshooting by erasing all data from the **Internal shared storage** location on the computer. Data is not erased from the **IPSM Card** location.





Caution: An Enterprise data reset results in data loss, only perform this procedure if all other recovery methods have failed. All personal content is erased including, but not limited to emails, pictures, contacts, Google account information, system settings and app settings.

Note: *This method of recovery may not be available if your system administrator has set policies to prevent the reset use.*

Before You Begin

- If you recently reset your Google Account password, wait 24 hours before performing a Enterprise data reset.
- Make sure you have your screen lock password, PIN or pattern if you activated one. You will need this to reset the computer.
- If you have a Google Account, back up your data and settings to your Google Account so you can restore them if needed.
- Connect the computer to an external power source or make sure you have a full battery charge.
- Make sure you have an Internet connection.

Enterprise Data Reset the Computer

1. Swipe up from the bottom of the Home screen to access all apps.
2. Select **Settings**  > **Backup & reset**.
3. Tap **Enterprise data reset**.
4. Tap **Reset Phone**.
5. If prompted, type your screen lock security pattern, PIN, or password and tap next ().

6. Tap **Erase Everything**. A message appears informing you an Enterprise data reset is being performed.

About a Factory Data Reset

A Factory Data Reset should only be performed if you have exhausted all other troubleshooting options. This method reverts the computer back to the factory state by erasing all data in **Internal shared storage** and the **IPSM Card** storage locations on the computer.



Caution: A Factory data reset results in data loss. Perform this procedure only if all other recovery methods have failed and have no other option. All personal content is erased including, but not limited to emails, pictures, contacts, Google account information, system settings and app settings.

Note: *This method of recovery may not be available if your system administrator has set policies to prevent the reset use.*

Before You Begin

- If you added a Google Account to the 75 Series computer, make sure you have your Google username and password associated with the computer. If you do not have the username and password, you will not be able to use the computer after the reset. This is a security measure that prevents unauthorized users from using the device if they try a Factory data reset.
- If you did not add a Google Account to the computer, the extra security level is not enabled and you will not need a Google username and password.
- If you recently reset your Google Account password, wait 24 hours before performing a Factory reset.
- Connect the computer to an external power source or make sure you have a full battery charge.
- Make sure you have an Internet connection.

Factory Data Reset the Computer

1. Swipe up from the bottom of the Home screen to access all apps.
2. Select **Settings**  > **Backup & reset**.
3. Tap **Factory data reset**.
4. Tap **Reset Phone**.
5. If prompted, type your screen lock security pattern, PIN, or password and tap next ().

6. Tap **Erase Everything**. A message appears informing you an Enterprise data reset is being performed.

Clean the Computer

To keep the computer in good working order, you may need to clean the scanner window, color camera window, and the touch screen. Clean the windows and the touch screen as often as needed for the environment in which you are using the computer. The computer withstands application of the following cleaning agents when applied to a clean soft cloth and removed immediately with a dry soft cloth:

- Acetic acid, 10% in water
- Ethyl alcohol, 10% in water
- Mild soap solutions

Note: *Always leave the battery installed when you clean the computer.*

1. Press the **Power** button to suspend the computer.
2. Dip a clean cloth towel in the cleaning agent and wring out the excess.
3. Wipe off the scanner window, camera lens, and flash area. Do not allow any abrasive material to touch these surfaces.
4. Wipe dry.
5. Let the computer completely air dry before using again.

Computer Agency Information

Dolphin CT60 mobile computers meet or exceed the requirements of all applicable standards organizations for safe operation. The best way to ensure safe operation is to use the mobile computer according to the agency guidelines on the product regulatory sheet, quick start guide, battery insert and in this user guide. Read all guidelines before using your computer.

Product documentation is available for download from www.honeywellaidc.com.

Public certificates are available for download from www.honeywellaidc.com/compliance.

Label Locations

Labels inside the battery compartment contain information about the computer including, compliance information, model number, serial number, IMEI number (CT60L1N models only) and MAC address. Laser safety labeling is located on the back of the computer.

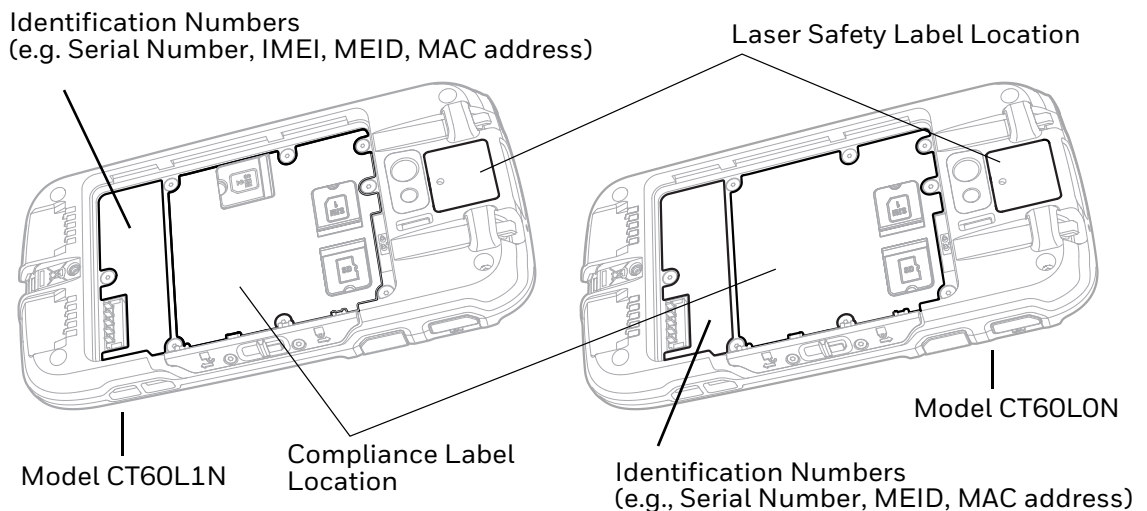

Physical and Environmental Specifications

1. Go to www.honeywellaidc.com.
2. Type **CT60** in the Search box and then press **Enter**.
3. Select the **Products** tab.
4. Click the red arrow under the *Dolphin CT60 Handheld Computer* description.
5. Select one of the following:
 - **Specifications**
View System Architecture, Wireless Connectivity, Mechanical, and Environmental specifications.
 - **Documents**
Download the Data Sheet, Accessory Guide, Quick Start Guide, User Guide, Regulatory Information, Battery Information and other product documentation.

Bar Code Symbolologies

The computer supports the following bar code symbolologies:

1D Symbolologies		2D Symbolologies		Postal Codes	
	Default		Default		Default
Codabar	Enabled	Aztec Code	Enabled	Australian Post	Disabled
Code 39	Enabled	Codablock A	Disabled	British Post	Disabled
Code 11	Disabled	Codablock F	Disabled	Canadian Post	Disabled
Code 32	Disabled	DataMatrix	Enabled	China Post	Disabled
Code 93	Disabled	DotCode	Disabled	Netherlands (KIX) Post	Disabled
Code 128	Enabled	Grid Matrix	Disabled	Japanese Post	Disabled
Composite	Disabled	HanXin	Disabled	Korean Post	Disabled
EAN-8	Enabled	Maxicode	Disabled	2D Postal Settings	Disabled
EAN-13	Enabled	Micro PDF 417	Disabled	Planet Code	Disabled
GS1-128	Enabled	PDF 417	Enabled	Postnet	Disabled
GS1 DataBar	Disabled	QR Code	Enabled	UsIntelligent	Disabled
IATA 2 of 5	Disabled	TLC 39	Disabled		
Standard 2 of 5	Disable	OCR	Disabled		
Interleaved 2 of 5	Enable				
ISBT 128	Disable				
Matrix 2 of 5	Disable				
MSI	Disable				
Telepen	Disable				
Trioptic Code	Disable				

1D Symbologies		2D Symbologies		Postal Codes	
	Default		Default		Default
UPC-A	Enabled				
UPC-E	Enabled				
UPC-E1	Enabled				

Note: To learn about changing the symbology settings, see [Change the Scanner Settings](#) on page 32.

N6600 Slim Imager Engine Reading Distances

The guaranteed depth of field measurements were taken using these parameters:

- Distances are measured from the front of the engine.
- +23 °C (+73 °F), 0 lux
- Photographic quality codes

Note: Time to Read and Depth of Field are impacted if the bar code symbol is at the edge of the image.

White Illumination Monochrome Sensor Only - Guaranteed Specs

Focus	Standard Range (SR)		
Symbology	Near Distance (in/cm)	Far Distance (in/cm)	Delta (in/cm)
5 mil Code 39/128	3.6 (9.1)	5.6 (14.2)	2.0 (5.1)
10 mil Code 39/128	1.9 (4.8)	12.0 (30.5)	10.1 (25.6)
100% UPC	2.1 (5.3)	15.1 (38.1)	12.9 (32.7)
6.7 mil PDF 417	2.5 (6.4)	6.6 (16.7)	4.1 (10.4)
10 mil DataMatrix/Aztec	2.9 (7.4)	7.3 (18.5)	4.4 (11.1)

White Illumination Monochrome Sensor Only - Typical Specs

Focus	Standard Range (SR)		
Symbology	Near Distance (in/cm)	Far Distance (in/cm)	Delta (in/cm)
5 mil Code 39/128	2.5 (6.4)	6.4 (16.3)	3.9 (9.9)
10 mil Code 39/128	1.1 (2.8)	13.0 (33.0)	11.9 (30.2)
100% UPC	1.8 (4.6)	16.5 (41.9)	14.7 (37.3)
6.7 mil PDF 417	1.8 (4.6)	7.3 (18.5)	5.5 (14.0)
10 mil DataMatrix/Aztec	2.1 (5.3)	8.0 (20.3)	5.9 (15.0)

N6600 Slim Imager Engine Field of View/Resolution

Focus	Standard Range (SR)
Horizontal Field Angle (degrees)	$\pm 21.2 \pm 3.5^\circ$
Vertical Field Angle (degrees)	$\pm 16.5 \pm 3.5^\circ$

Note: *DPI can be calculated based on the following formula:
Horizontal DPI = 832 pixels/width of horizontal field of view (inches)
Vertical DPI = 640 pixels/width of vertical field of view (inches)*

Honeywell
9680 Old Bailes Road
Fort Mill, SC 29707

www.honeywellaidc.com