

INSTALLATION INSTRUCTIONS

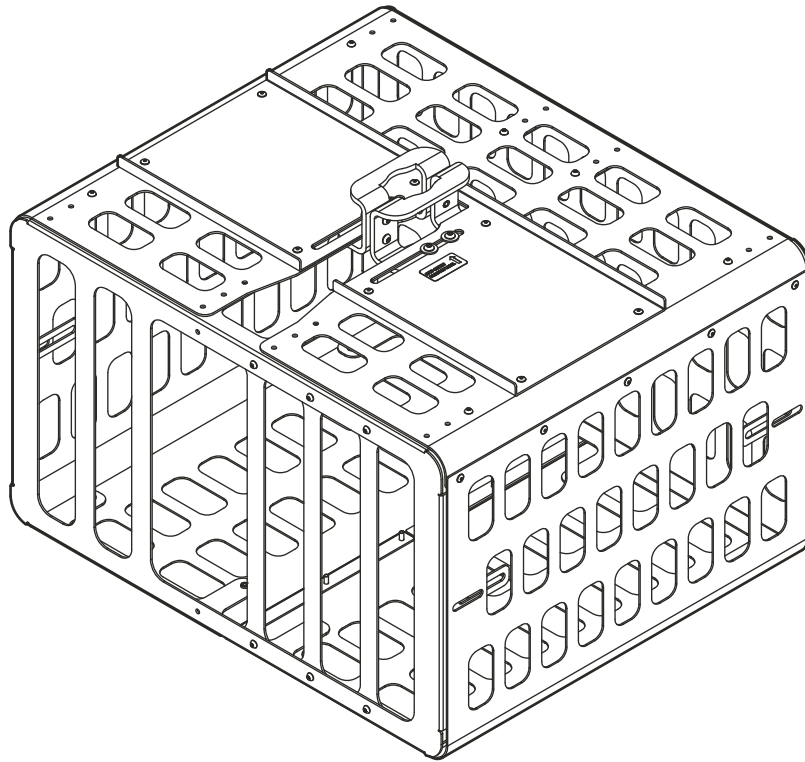

XXL Projector Guard

DISCLAIMER

Milestone AV Technologies and its affiliated corporations and subsidiaries (collectively "Milestone"), intend to make this manual accurate and complete. However, Milestone makes no claim that the information contained herein covers all details, conditions or variations, nor does it provide for every possible contingency in connection with the installation or use of this product. The information contained in this document is subject to change without notice or obligation of any kind. Milestone makes no representation of warranty, expressed or implied, regarding the information contained herein. Milestone assumes no responsibility for accuracy, completeness or sufficiency of the information contained in this document.

Chief® is a registered trademark of Milestone AV Technologies. All rights reserved.

DEFINITIONS

MOUNTING SYSTEM: A MOUNTING SYSTEM is the primary Chief product to which an accessory and/or component is attached.

ACCESSORY: AN ACCESSORY is the secondary Chief product which is attached to a primary Chief product, and may have a component attached or setting on it.

COMPONENT: A COMPONENT is an audiovisual item designed to be attached or resting on an accessory or mounting system such as a video camera, CPU, screen, display, projector, etc.



WARNING: A WARNING alerts you to the possibility of serious injury or death if you do not follow the instructions.



CAUTION: A CAUTION alerts you to the possibility of damage or destruction of equipment if you do not follow the corresponding instructions.



IMPORTANT SAFETY INSTRUCTIONS



WARNING: Failure to read, thoroughly understand, and follow all instructions can result in serious personal injury, damage to equipment, or voiding of factory warranty! It is the installer's responsibility to make sure all accessories are properly assembled and installed using the instructions provided.



WARNING: Failure to provide adequate structural strength for this accessory can result in serious personal injury or damage to equipment! It is the installer's responsibility to make sure the structure to which this accessory is attached can support five times the combined weight of all equipment. Reinforce the structure as required before installing the accessory.



WARNING: Use this accessory only for its intended use as described in these instructions. Do not use attachments not recommended by the manufacturer.



WARNING: Never operate this accessory if it is damaged. Return the accessory to a service center for examination and repair.



WARNING: Do not use this accessory outdoors.

IMPORTANT ! : The PG4A accessory is designed to be attached to a 1-1/2" column.



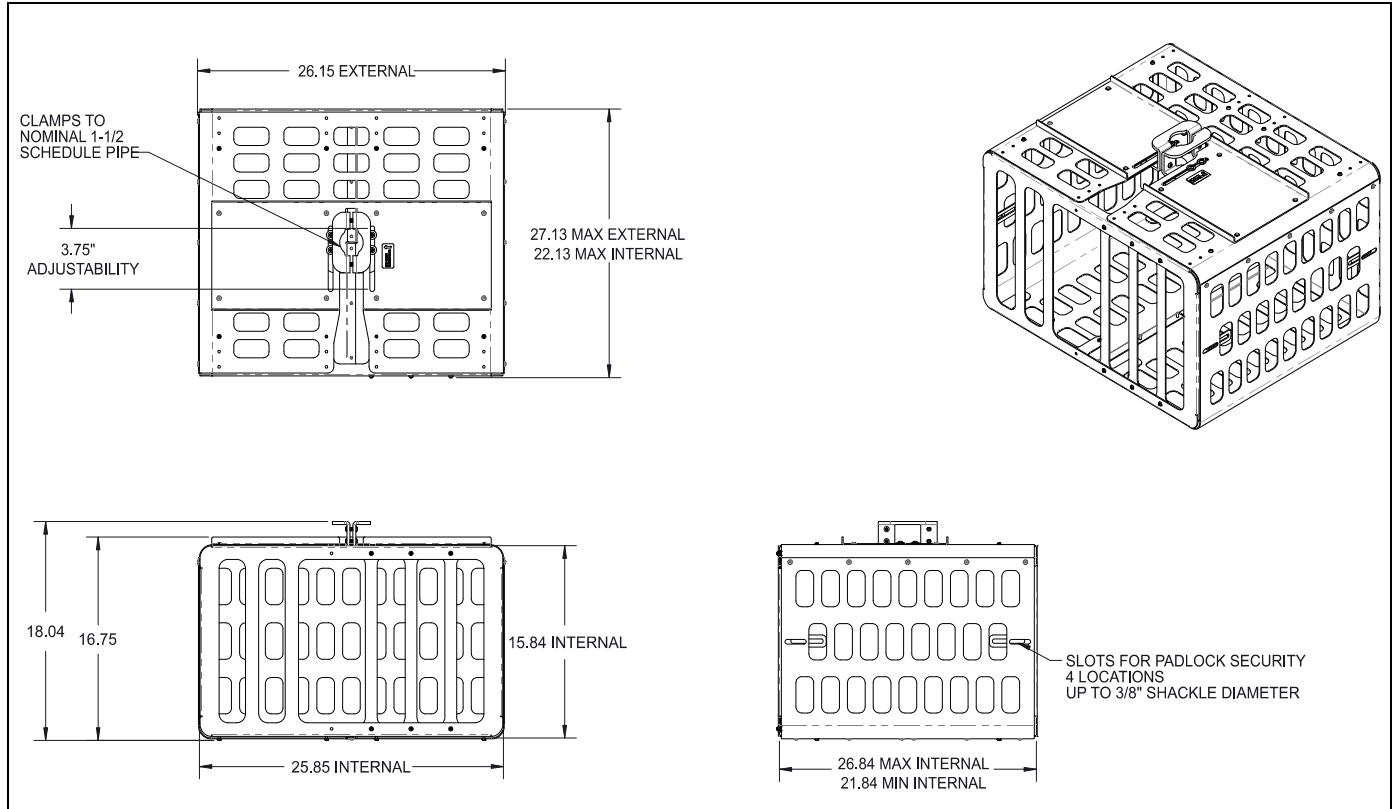

IMPORTANT ! : These installation instructions assume that a 1-1/2" diameter extension column (not included) has been properly installed and is in place.

--SAVE THESE INSTRUCTIONS--

DIMENSIONS

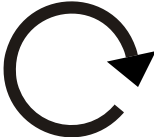

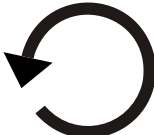
LEGEND

| | | | |
|---|------------------------------|--|---------------------------|
|  | Tighten Fastener |  | Security Wrench |
| | Apretar elemento de fijación | | Llave de seguridad |
| | Befestigungsteil festziehen | | Sicherheitsschlüssel |
| | Apertar fixador | | Chave de segurança |
| | Serrare il fissaggio | | Chiave di sicurezza |
| | Bevestiging vastdraaien | | Veiligheidsleutel |
| | Serrez les fixations | | Clé de sécurité |
|  | Loosen Fastener |  | Hex-Head Wrench |
| | Aflojar elemento de fijación | | Llave de cabeza hexagonal |
| | Befestigungsteil lösen | | Sechskantschlüssel |
| | Desapertar fixador | | Chave de cabeça sextavada |
| | Allentare il fissaggio | | Chiave esagonale |
| | Bevestiging losdraaien | | Zeskantsleutel |
| | Desserrez les fixations | | Clé à tête hexagonale |

TOOLS REQUIRED FOR INSTALLATION

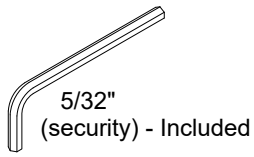

PARTS

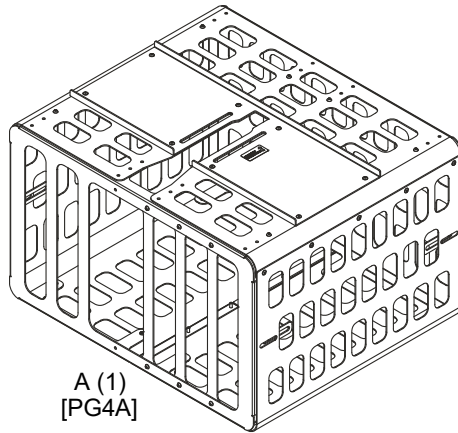

A (1)
[PG4A]

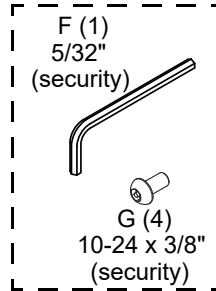
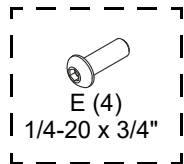
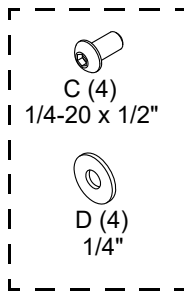
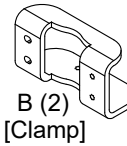

INSTALLATION

IMPORTANT ! : These installation instructions assume that a 1-1/2" diameter extension column (not included) has been properly installed and is in place, along with the projector.

NOTE: The PG4A (A) ships in its most compact configuration, but can be adjusted to fit larger projectors.

1. Remove **AND SAVE** four fasteners (two from top and two from bottom) from the front of the PG4A (A). (See Figure 1)
2. Remove front face of the PG4A. (See Figure 1)

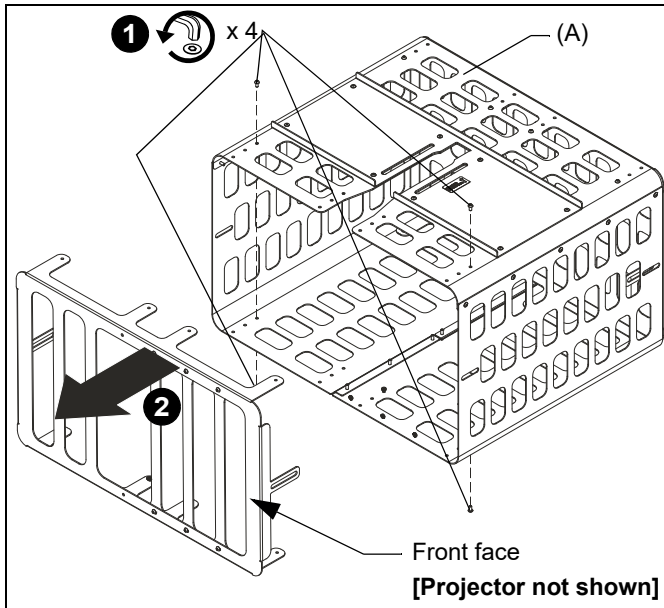

Figure 1

3. Attach two clamps (B) to installed column using four 1/4-20 x 3/4" button head cap screws (E), two through each clamp. (See Figure 2)

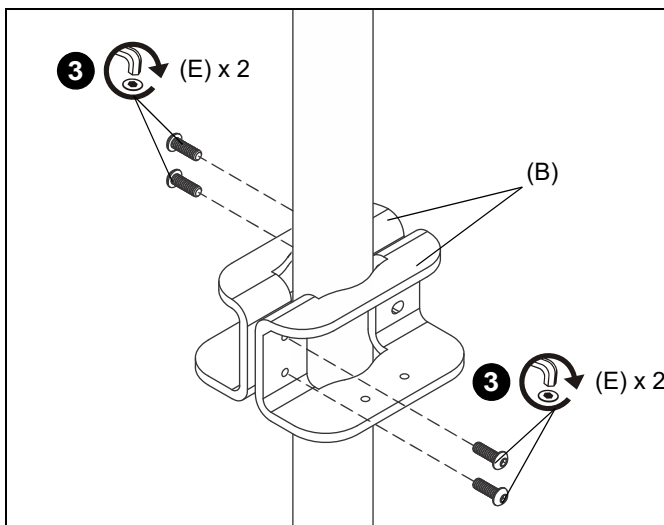

Figure 2

4. Slide the PG4A over the bottom flange of the installed clamps (B). (See Figure 3)
5. Fasten PG4A to clamps through slots in PG4A with four 1/4-20 x 1/2" button head cap screws (C) and four 1/4" washers (D). (See Figure 3)

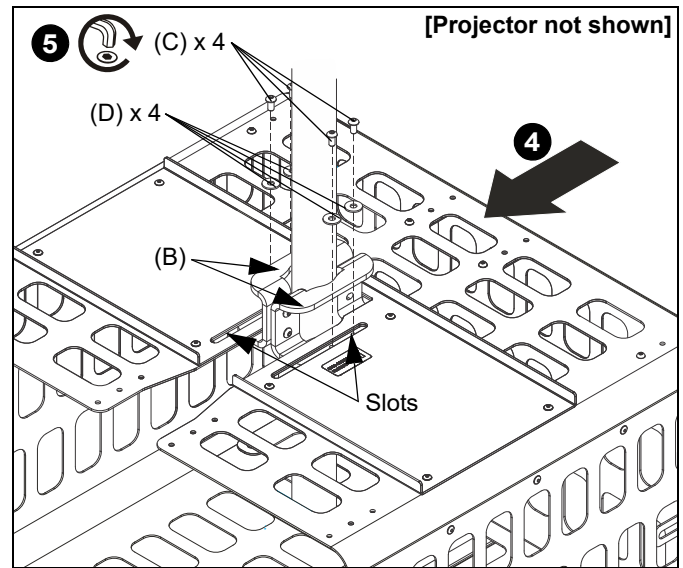

Figure 3

6. Slide the front face of the PG4A back into the PG4A, aligning the fastener holes on the front face with the fastener holes at the selected cage size. (See Figure 4)
7. Fasten PG4A front face in place using four security button head screws removed in **Step 1**, and four 10-24 x 3/8" security button head screws (G). (See Figure 4)

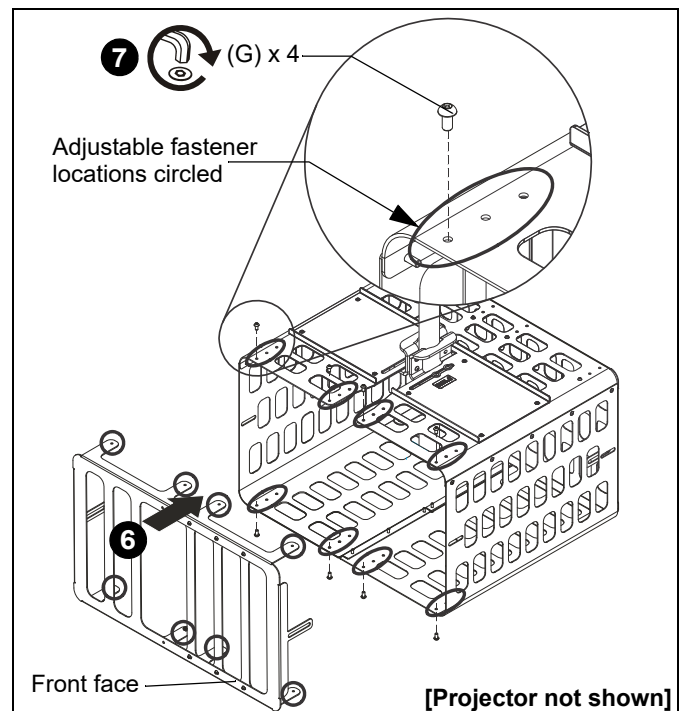

Figure 4

8. For added security, install a padlock (not included) in one of the four locations noted. (See Figure 5)

NOTE: The padlock shackle diameter cannot exceed 3/8".

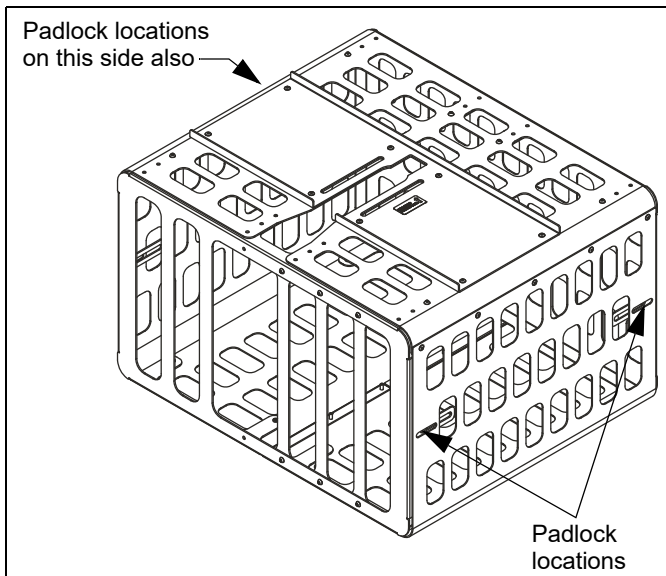

Figure 5



Our Mounts. **Your Vision.**

Chief, a products division of
Milestone AV Technologies

8800-003083 Rev00
©2018 Milestone AV Technologies
www.milestone.com
08/18

| | |
|--------------------------|--|
| USA/International | A 6436 City West Parkway, Eden Prairie, MN 55344 P 800.582.6480 / 952.225.6000 F 877.894.6918 / 952.894.6918 |
| Europe | A Franklinstraat 14, 6003 DK Weert, Netherlands P +31 (0) 495 580 852 F +31 (0) 495 580 845 |
| Asia Pacific | A Office No. 918 on 9/F, Shatin Galleria 18-24 Shan Mei Street Fotan, Shatin, Hong Kong P 852 2145 4099 F 852 2145 4477 |

