

# Precision 3280 CFF

## Owner's Manual

## Notes, cautions, and warnings

 **NOTE:** A NOTE indicates important information that helps you make better use of your product.

 **CAUTION:** A CAUTION indicates either potential damage to hardware or loss of data and tells you how to avoid the problem.

 **WARNING:** A WARNING indicates a potential for property damage, personal injury, or death.



# Contents

<b>Chapter 1: Views of Precision 3280 CFF.....</b>	<b>7</b>
Front.....	8
Back.....	10
<b>Chapter 2: Set up your Precision 3280 CFF.....</b>	<b>12</b>
<b>Chapter 3: Specifications of Precision 3280 CFF.....</b>	<b>21</b>
Dimensions and weight.....	21
Processor.....	21
Chipset.....	22
Operating system.....	22
Memory.....	22
Memory matrix.....	23
External ports and slots.....	23
Internal slots.....	24
Ethernet.....	24
Wireless module.....	24
Audio.....	25
Storage.....	26
Storage matrix.....	26
RAID (Redundant Array of Independent Disks).....	26
Power adapter.....	27
GPU—Integrated.....	27
Multiple display support matrix.....	28
GPU—Discrete.....	28
Video port resolution.....	28
Hardware security.....	29
Environmental.....	30
Regulatory compliance.....	30
Operating and storage environment.....	30
Dell support policy.....	31
Dell Optimizer.....	31
<b>Chapter 4: Working inside your computer.....</b>	<b>32</b>
Safety instructions.....	32
Before working inside your computer.....	32
Safety precautions.....	33
Electrostatic discharge—ESD protection.....	33
ESD Field Service kit .....	34
Transporting sensitive components.....	35
After working inside your computer.....	35
BitLocker.....	35
Recommended tools.....	35
Screw list.....	36

Major components of Precision 3280 CFF.....	36
<b>Chapter 5: Removing and installing coin-cell battery.....</b>	<b>39</b>
Removing the coin-cell battery.....	39
Installing the coin-cell battery.....	40
<b>Chapter 6: Removing and installing Customer Replaceable Units (CRUs).....</b>	<b>41</b>
Side cover.....	41
Removing the side cover.....	41
Installing the side cover.....	43
Memory module.....	45
Removing the memory modules.....	45
Installing the memory modules.....	46
Riser-card module.....	47
Removing the riser-card module.....	47
Installing the riser-card module.....	48
Solid state drive.....	49
SSD slot 1 and slot 2 cooling matrix .....	49
Removing the M.2 2230 SSD (slot-1).....	50
Removing the M.2 2230 SSD (slot-2).....	51
Installing the M.2 2230 SSD (slot-1).....	51
Installing the M.2 2230 SSD (slot-2).....	52
Removing the M.2 2280 PCIe SSD (slot-1).....	53
Removing the M.2 2280 PCIe SSD (slot-2).....	54
Installing the M.2 2280 PCIe SSD (slot-1).....	55
Installing the M.2 2280 PCIe SSD (slot-2).....	56
Installing M.2 2230/2280 SSDs onto a 2230/2280 heat sink module.....	57
Installing the M.2 2230 SSD onto a 2230 SSD heat sink module.....	57
Installing the M.2 2280 SSD onto a 2280 SSD heat sink module.....	59
Solid state drive with heat sink module.....	61
SSD slot 1 and slot 2 cooling matrix .....	61
Removing the M.2 2230 SSD (slot-2) with heat sink module.....	62
Installing the M.2 2230 SSD (slot-2) with heat sink module.....	64
Removing the M.2 2280 PCIe SSD (slot-2) with heat sink module.....	65
Installing the M.2 2280 PCIe SSD (slot-2) with heat sink module.....	67
WLAN card.....	68
Removing the wireless card.....	68
Installing the wireless card.....	69
Speaker.....	71
Removing the speaker.....	71
Installing the speaker.....	71
Graphics card.....	72
Removing the NVIDIA T1000 graphics card .....	72
Installing the NVIDIA T1000 graphics card.....	73
<b>Chapter 7: Removing and installing Field Replaceable Units (FRUs).....</b>	<b>75</b>
Processor fan.....	75
Removing the processor fan.....	75
Installing the processor fan.....	76

Heat sink.....	77
Removing the heat sink.....	77
Installing the heat sink.....	79
Processor.....	80
Removing the processor.....	80
Installing the processor.....	80
System board.....	81
Removing the system board.....	81
Installing the system board.....	85
Power button.....	89
Removing the power button.....	89
Installing the power button.....	90
Internal antenna.....	90
Removing the internal antenna—location 1.....	90
Installing the internal antenna—location 1.....	91
Removing the internal antenna—location 2.....	93
Installing the internal antenna—location 2.....	95
<b>Chapter 8: Software.....</b>	<b>98</b>
Operating system.....	98
Drivers and downloads.....	98
<b>Chapter 9: Technology and components.....</b>	<b>99</b>
System management features.....	99
Dell Client Command Suite for in-band systems management .....	99
Out-of-band systems management.....	99
<b>Chapter 10: BIOS Setup.....</b>	<b>100</b>
Entering BIOS Setup program.....	100
Navigation keys.....	100
One time boot menu.....	100
System setup options.....	101
Updating the BIOS.....	110
Updating the BIOS in Windows.....	110
Updating the BIOS in Linux and Ubuntu.....	110
Updating the BIOS using the USB drive in Windows.....	110
Updating the BIOS from the One-Time boot menu.....	111
System and setup password.....	111
Assigning a System Setup password.....	112
Deleting or changing an existing system password or setup password.....	112
Clearing CMOS settings.....	113
Clearing BIOS (System Setup) and System passwords.....	113
<b>Chapter 11: Troubleshooting.....</b>	<b>114</b>
Dell SupportAssist Pre-boot System Performance Check diagnostics.....	114
Running the SupportAssist Pre-Boot System Performance Check.....	114
Power-Supply Unit Built-in Self-Test .....	114
System-diagnostic lights.....	115
Recovering the operating system.....	116

Real Time Clock—RTC reset.....116  
Backup media and recovery options..... 117  
Wi-Fi power cycle..... 117

**Chapter 12: Getting help and contacting Dell..... 118**



# Views of Precision 3280 CFF

## Front

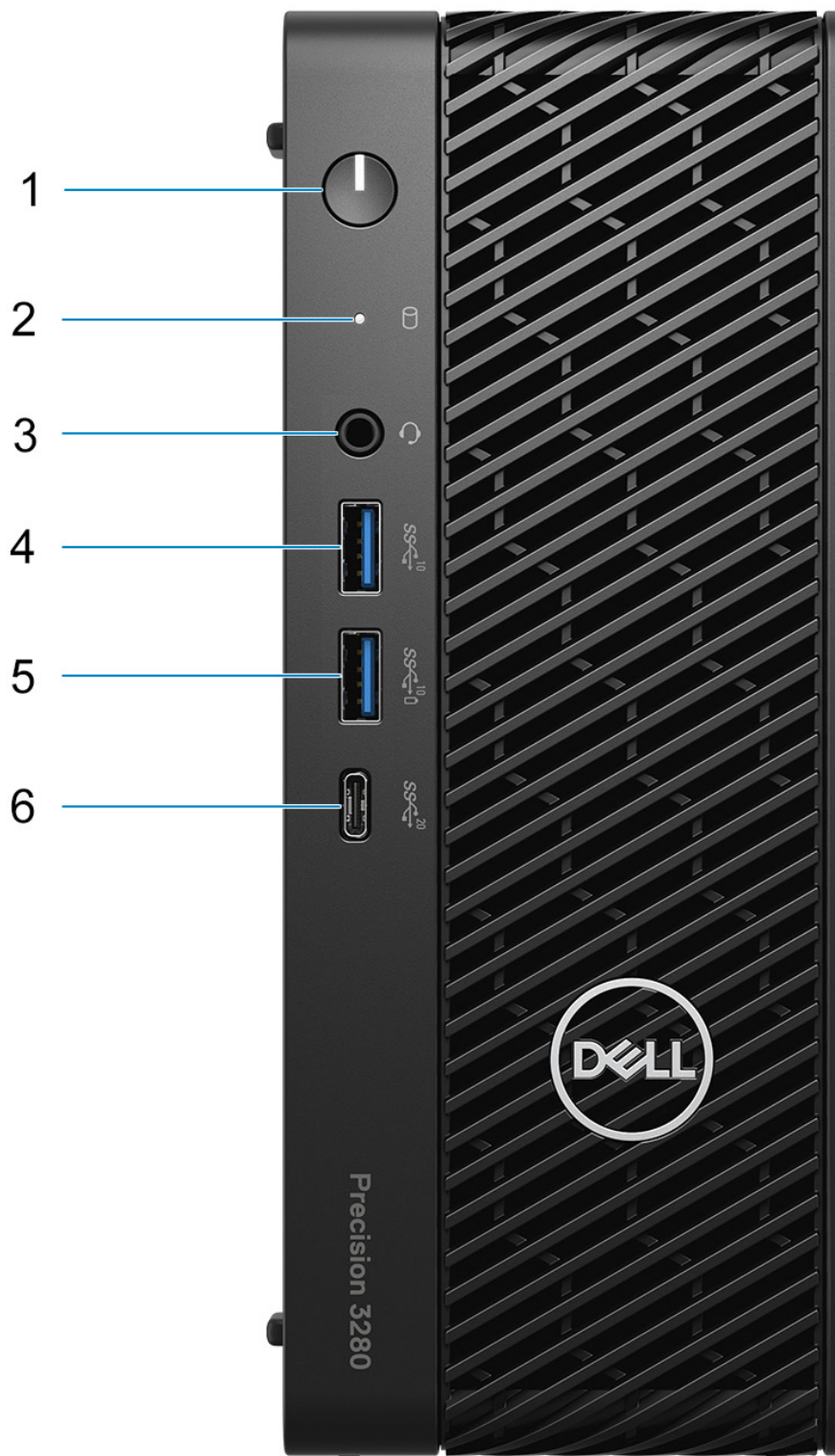



Figure 1. Front view

**1. Power button with diagnostic LED**

Press to turn on the computer if it is turned off, in sleep state, or in hibernate state.

**2. Hard-drive activity light**

Turns on when the computer reads from or writes to the hard drive.

 **NOTE:** Hard-drive activity light is supported only on computers that are shipped with hard drive.

**3. Universal audio port**

Connect headphones or a headset (headphone and microphone combo).

**4. USB 3.2 Gen 2 (10 Gbps) port**

Connect devices such as external storage devices and printers. Provides data transfer speeds up to 10 Gbps.

**5. USB 3.2 Gen 2 (10 Gbps) port with PowerShare**

Connect devices such as external storage devices and printers.

Provides data transfer speeds up to 10 Gbps. PowerShare enables you to charge connected USB devices.

**6. USB 3.2 Type-C Gen 2x2 (20 Gbps) port**

Connect devices such as external storage devices, printers, and external displays. Provides data transfer rate of up to 20 Gbps.

 **NOTE:** Connected USB devices will not charge when the computer is turned off or in a sleep state. To start charging connected devices, turn on the computer.

# Back

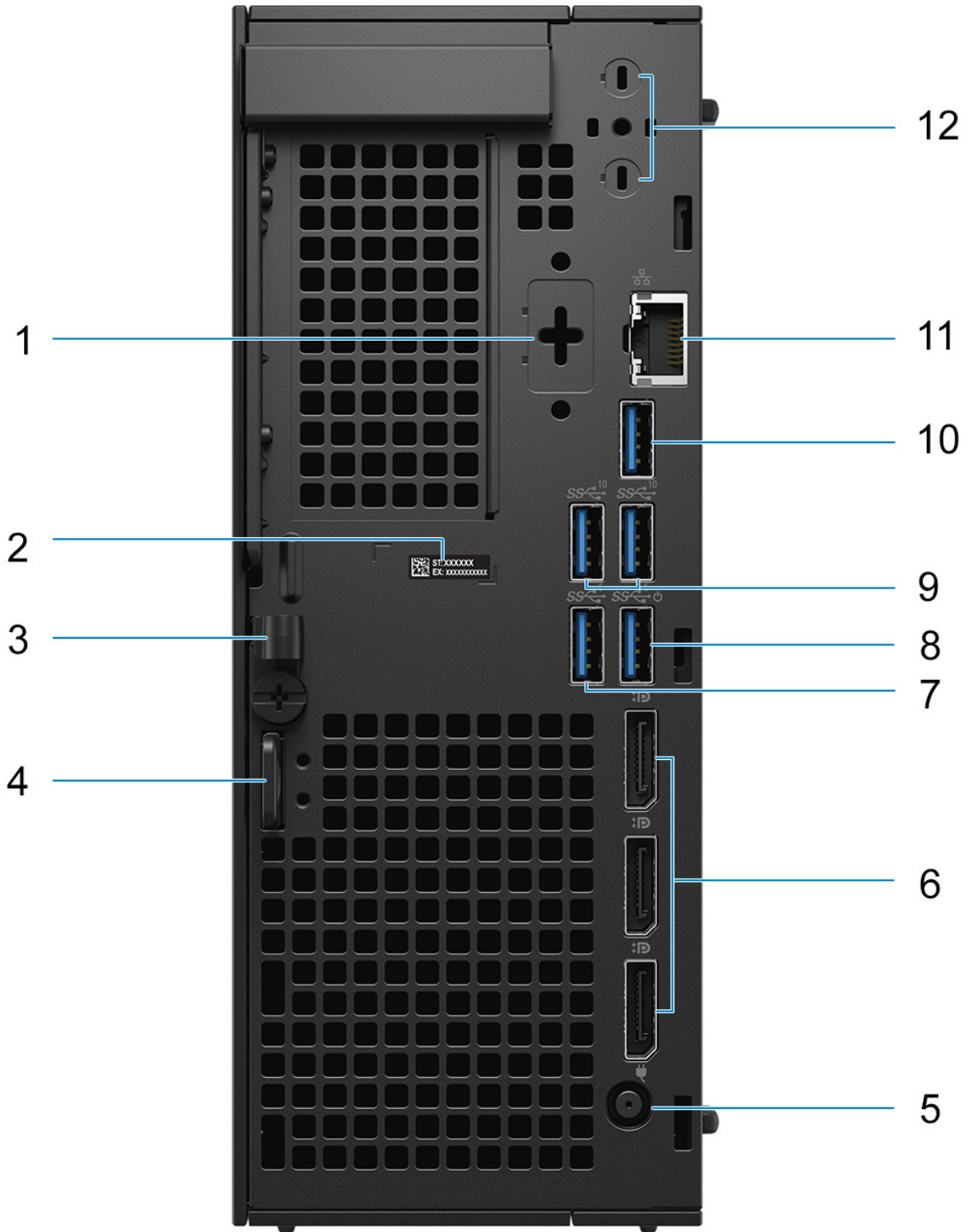

Figure 2. Back view



## 1. **Optional port (HDMI 2.1/Displayport 1.4a (HBR3)/VGA/USB Type-C with DisplayPort Alt mode)**

The port available at this location may vary depending on the optional I/O card that is installed on your computer.

- **HDMI 2.1 port**

Connect to a TV, external display, or another HDMI-in enabled device. Maximum resolution that is supported up to 4096 x 2160 @60 Hz.

- **DisplayPort 1.4a (HBR3 support)**

Connect an external display or a projector. Maximum resolution that is supported up to 5120 x 3200 @60 Hz.

- **VGA port**

Connect an external display or a projector. Maximum resolution that is supported up to 1920 x 1200 @60 Hz.

- **USB Type-C with DisplayPort port**

Connect devices such as external storage devices and printers. Provides data transfer speeds of up to 10 Gbps. Maximum resolution supported up to 5120x3200 @60Hz with a Type-C to DisplayPort adapter.

## 2. **Service Tag label**

The Service Tag is a unique alphanumeric identifier that enables Dell service technicians to identify the hardware components in your computer and access warranty information.

## 3. **DC-in cable clip**

For power-adapter cable routing.

## 4. **Side cover release latch**

Release to allow to open the side cover.

## 5. **Power cord connector port**

Connect a power cable to provide power to your computer.

## 6. **Three DisplayPort 1.4a (HBR2) ports**

Connect an external display or a projector.

## 7. **USB 3.2 Gen 1 (5 Gbps) port**

Connect devices such as external storage devices and printers. Provides data transfer speeds up to 5 Gbps.

## 8. **USB 3.2 Gen 1 (5 Gbps) with Smart Power On port**

Connect devices such as external storage devices and printers. Provides data transfer speeds up to 5 Gbps.

## 9. **Two USB 3.2 Gen 2 (10 Gbps) ports**

Connect devices such as external storage devices and printers. Provides data transfer speeds up to 10 Gbps.

## 10. **One USB 3.2 Gen 2 (10 Gbps) port**

Connect devices such as external storage devices and printers. Provides data transfer speeds up to 10 Gbps.

## 11. **RJ45 port 10/100/1000 Mbps**

Connect an Ethernet (RJ45) cable from a router or a broadband modem for network or Internet access, with a transfer rate of 10/100/1000 Mbps.

## 12. **External antenna connector ports**

# Set up your Precision 3280 CFF

## About this task

 **NOTE:** The images in this document may differ from your system depending on the configuration you ordered.

## Steps

1. Connect the keyboard and mouse.

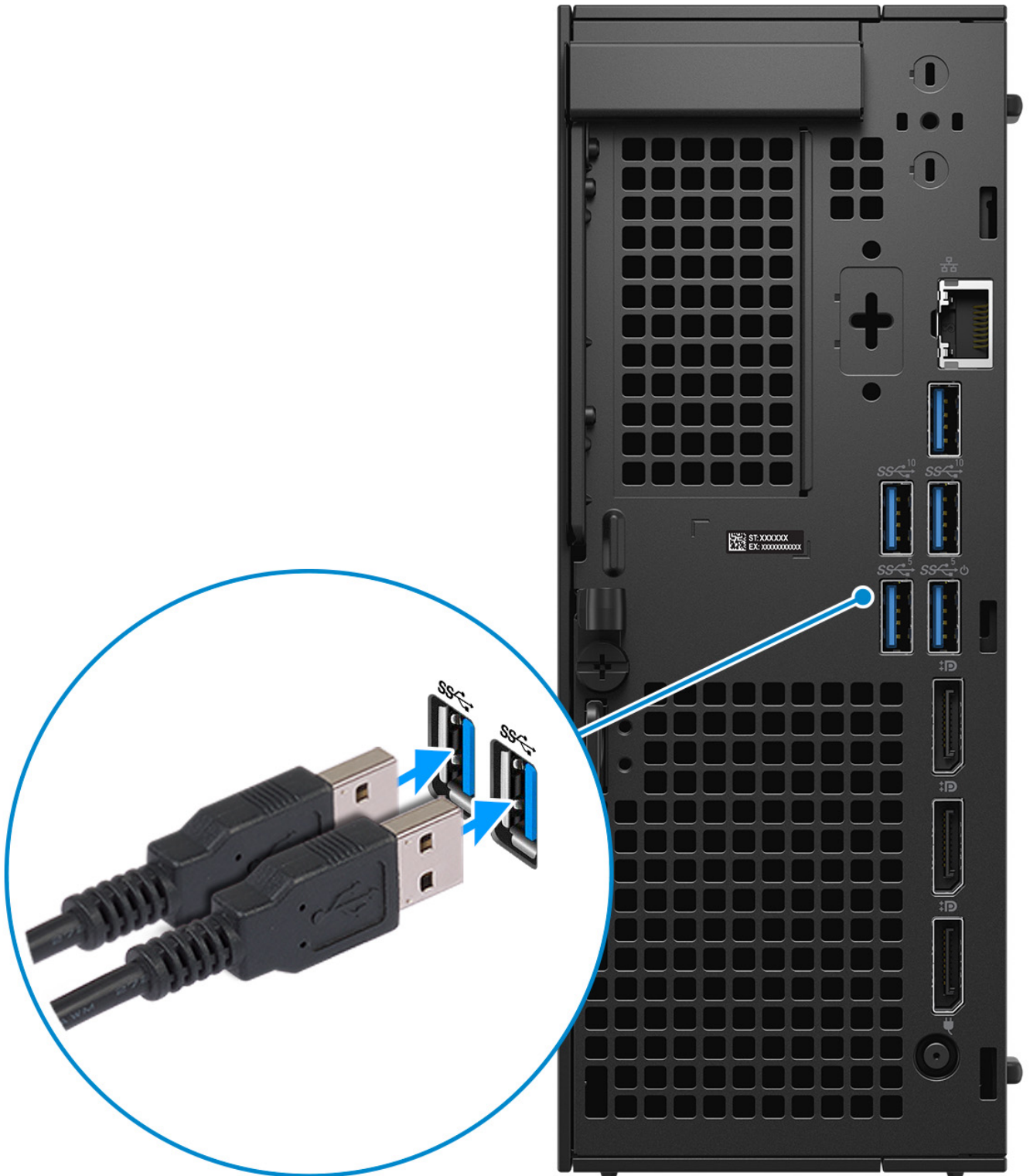

Figure 3. Connect the keyboard and mouse

2. Connect to your network using a cable, or connect to a wireless network.

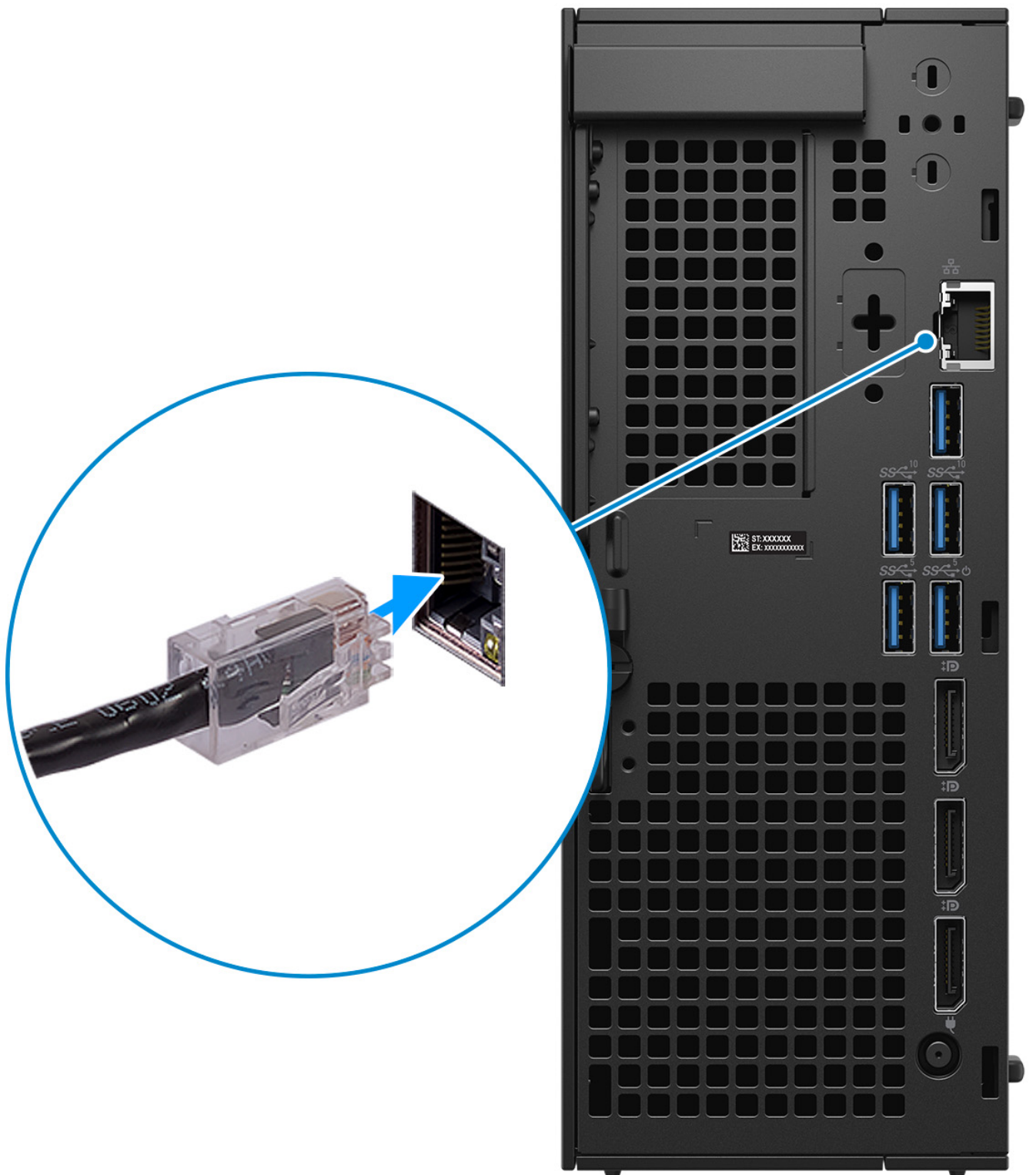

Figure 4. Connect the network cable

3. Connect the display.



**Figure 5. Connect the display**

4. Connect the power cable.

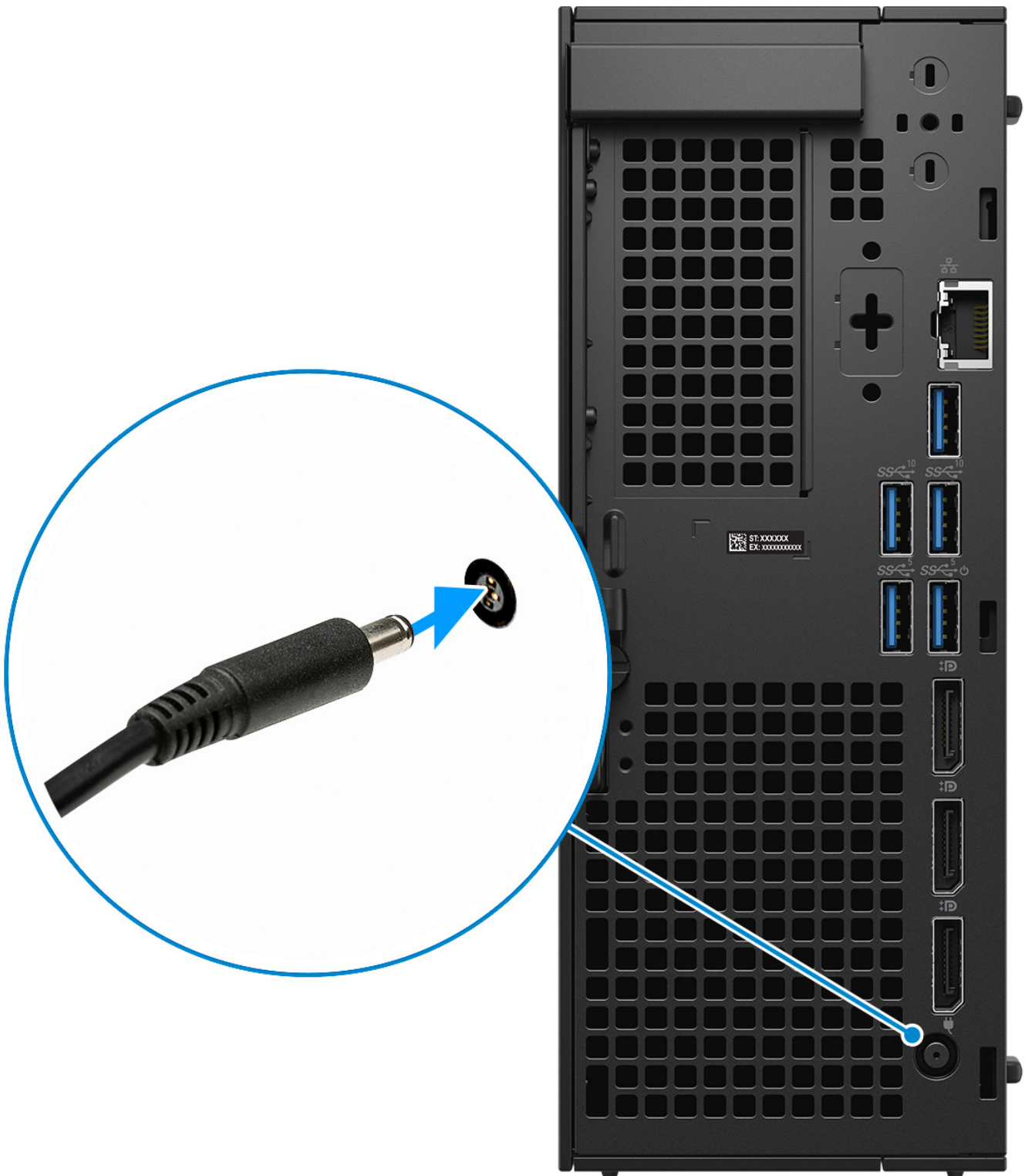

Figure 6. Connect the power cable

5. Press the power button.





Figure 7. Press the power button

6. Finish the operating system setup.

**For Ubuntu:**

Follow the on-screen instructions to complete the setup. For more information about installing and configuring Ubuntu, search in the Knowledge Base Resource at [Dell Support Site](#).





**For Windows:**

Follow the on-screen instructions to complete the setup. When setting up, Dell Technologies recommends that you:

- Connect to a network for Windows updates.
  - ① **NOTE:** If connecting to a secured wireless network, enter the password for the wireless network access when prompted.
- If connected to the Internet, sign-in with or create a Microsoft account. If not connected to the Internet, create an offline account.
- On the **Support and Protection** screen, enter your contact details.

7. We recommend looking for Dell apps in the Windows Start menu.

**Table 1. Locate Dell apps**

Resources	Description
	<p><b>Dell Product Registration</b></p> <p>Register your computer with Dell.</p>
	<p><b>Dell Help &amp; Support</b></p> <p>Access help and support for your computer.</p>
	<p><b>SupportAssist</b></p> <p>SupportAssist is the smart technology that keeps your computer running at its best by optimizing settings, detecting issues, removing viruses and notifies when you must make computer updates. SupportAssist proactively checks the health of your computer hardware and software. When an issue is detected, the necessary system state information is sent to Dell to begin troubleshooting. SupportAssist is preinstalled on most of the Dell devices running the Windows operating system. For more information, see <i>SupportAssist for Business PCs manuals</i> at <a href="#">SupportAssist for Business PCs</a>.</p> <p>① <b>NOTE:</b> In SupportAssist, click the warranty expiry date to renew or upgrade your warranty.</p>
	<p><b>Dell Update</b></p> <p>Updates your computer with critical fixes and latest device drivers as they become available. For more information about using Dell Update, see the product guides and third-party license documents at <a href="#">Dell Support Site</a>.</p>
	<p><b>Dell Digital Delivery</b></p> <p>Download software applications, which are purchased but not preinstalled on your computer. For more information about using Dell Digital Delivery, search in the Knowledge Base Resource at <a href="#">Dell Support Site</a>.</p>

# Specifications of Precision 3280 CFF

## Dimensions and weight

The following table lists the height, width, depth, and weight of your Precision 3280 CFF.





**Table 2. Dimensions and weight**

Description	Values
Height	206.00 mm (8.11 in.)
Width	79.30 mm (3.12 in.)
Depth	178.00 mm (7.00 in.)
Weight  <b>NOTE:</b> The weight of your computer depends on the configuration ordered and manufacturing variability.	<ul style="list-style-type: none"> <li>• Minimum - 1.83 kg (4.03 lbs)</li> <li>• Maximum - 2.54 kg (5.59 lbs)</li> </ul>

## Processor

The following table lists the details of the processors that are supported in your Precision 3280 CFF.

**Table 3. Processor**

Description	Option one	Option two	Option three	Option four	Option five
Processor type	Intel Core i3-14100	Intel Core i5-14500 vPro	Intel Core i5-14600 vPro	Intel Core i7-14700 vPro	Intel Core i9-14900 vPro
Processor wattage	60W	65W  <b>NOTE:</b> In Optimized mode, the 65W CPU run at 80W PL1 min.	65W  <b>NOTE:</b> In Optimized mode, the 65W CPU run at 80W PL1 min.	65W  <b>NOTE:</b> In Optimized mode, the 65W CPU run at 80W PL1 min.	65W  <b>NOTE:</b> In Optimized mode, the 65W CPU run at 80W PL1 min.
Processor core count	4	14	14	20	24
Processor thread count	8	20	20	28	32
Processor speed	3.5 GHz to 4.7 GHz Turbo	2.6 GHz to 5.0 GHz Turbo	2.7 GHz to 5.2 GHz Turbo	2.1 GHz to 5.4 GHz Turbo	2.0 GHz to 5.8 GHz Turbo
Processor cache	12 MB	24 MB	24 MB	33 MB	36 MB
Integrated graphics	Intel UHD Graphics 730	Intel UHD Graphics 770	Intel UHD Graphics 770	Intel UHD Graphics 770	Intel UHD Graphics 770

# Chipset

The following table lists the details of the chipset that is supported in your Precision 3280 CFF.

**Table 4. Chipset**

Description	Values
Chipset	W680
Processor	Intel Core i3/i5/i7/i9
DRAM bus width	64-bit DIMM
Flash EPROM	16 MB + 32 MB
PCIe bus	Up to Gen4

# Operating system

Your Precision 3280 CFF supports the following operating systems:

- Windows 11 Home, 64-bit
- Windows 11 Pro, 64-bit
- Windows 11 Pro National Education, 64-bit
- Windows 11 Pro for Workstations
- Red Hat Linux 9.4 Enterprise
- Ubuntu Linux 22.04 LTS, 64-bit

# Memory

The following table lists the memory specifications that are supported by your Precision 3280 CFF.

**Table 5. Memory specifications**

Description	Values
Memory slots	Two-DIMM slots
Memory type	DDR5
Memory speed	Maximum speed: 5600 MT/s Maximum memory speed varies by the following configuration on each channel. If the two DIMM configuration is not symmetrical, the maximum speed may drop.
Maximum memory configuration	64 GB
Minimum memory configuration	8 GB
Memory size per slot	8 GB, 16 GB, and 32 GB
Memory configurations supported	<ul style="list-style-type: none"><li>• 8 GB: 1 x 8 GB, DDR5, 5600 MT/s, Non-ECC</li><li>• 16 GB: 2 x 8 GB, DDR5, 5600 MT/s, Non-ECC, dual-channel</li><li>• 16 GB: 1 x 16 GB, DDR5, 5600 MT/s, Non-ECC</li><li>• 32 GB: 2 x 16 GB, DDR5, 5600 MT/s, Non-ECC, dual-channel</li></ul>

**Table 5. Memory specifications (continued)**

Description	Values
	<ul style="list-style-type: none"> <li>64 GB: 2 x 32 GB, DDR5, 5600 MT/s, Non-ECC, dual-channel</li> <li>16 GB: 1 x 16 GB, DDR5, 5600 MT/s, ECC</li> <li>32 GB: 2 x 16 GB, DDR5, 5600 MT/s, ECC, dual-channel</li> <li>32 GB: 1 x 32 GB, DDR5, 5200 MT/s, ECC</li> <li>64 GB: 2 x 32 GB, DDR5, 5200 MT/s, ECC, dual-channel</li> </ul>

## Memory matrix

The following table lists the memory configurations supported on your Precision 3280 CFF.

**Table 6. Memory matrix for Non-ECC**

Configuration	Slots	
	DIMM1	DIMM2
8 GB DDR5	8 GB	N/A
16 GB DDR5	8 GB	8 GB
16 GB DDR5	16 GB	N/A
32 GB DDR5	16 GB	16 GB
64 GB DDR5	32 GB	32 GB

**Table 7. Memory matrix for ECC**

Configuration	Slots	
	DIMM1	DIMM2
16 GB DDR5	16 GB	N/A
32 GB DDR5	16 GB	16 GB
32 GB DDR5	32 GB	N/A
64 GB DDR5	32 GB	32 GB

## External ports and slots

The following table lists the external ports of your Precision 3280 CFF.

**Table 8. External ports and slots**

Description	Values
Network port	One RJ45 (1 GbE) Ethernet port
USB ports	Front: <ul style="list-style-type: none"> <li>One USB 3.2 Gen 2x2 (20 Gbps) Type-C port</li> <li>Two USB 3.2 Gen 2 (10 Gbps) with PowerShare ports</li> </ul> Rear: <ul style="list-style-type: none"> <li>One USB 3.2 Gen 1 (5 Gbps) with smart power on port</li> <li>One USB 3.2 Gen 1 (5 Gbps)</li> <li>Three USB 3.2 Gen 2 (10 Gbps) ports</li> </ul>

**Table 8. External ports and slots (continued)**

Description	Values
Audio port	One Universal Audio port
Video port(s)	<ul style="list-style-type: none"> <li>Three DisplayPort 1.4a (HBR2) ports</li> <li>One Optional Port (HDMI 2.1/DisplayPort 1.4a (HBR3)/VGA/USB Type-C with DisplayPort Alt mode)</li> </ul> <p><b>NOTE:</b> Download and install the latest Intel Graphics driver from <a href="#">Dell Support Site</a> to enable multiple displays.</p>
Media-card reader	N/A
Power-adaptor port	One Power-adaptor port
Security-cable slot	One Kensington security-cable slot

## Internal slots

The following table lists the internal slots of your Precision 3280 CFF.

**Table 9. Internal slots**

Description	Values
M.2	<ul style="list-style-type: none"> <li>One M.2 2230 slot for WiFi and Bluetooth card</li> <li>Two M.2 2230/2280 Gen4 PCIe NVMe SSD</li> </ul> <p><b>NOTE:</b> To learn more about the features of different types of M.2 cards, search in the Knowledge Base Resource at <a href="#">Dell Support Site</a>.</p>

## Ethernet

The following table lists the wired Ethernet Local Area Network (LAN) specifications of your Precision 3280 CFF.

**Table 10. Ethernet specifications**

Description	Values
Model number	Intel I219-LM
Transfer rate	10/100/1000 Mbps

## Wireless module

The following table lists the Wireless Local Area Network (WLAN) modules that are supported on your Precision 3280 CFF.

**Table 11. Wireless module specifications**

Description	Option one	Option two
Model number	Intel AX211	Qualcomm WCN6856-DBS
Transfer rate	2400 Mbps	Up to 3571 Mbps
Frequency bands supported	2.4 GHz/5 GHz/6 GHz	2.4 GHz/5 GHz/6 GHz

**Table 11. Wireless module specifications (continued)**

Description	Option one	Option two
	<p><b>i</b> <b>NOTE:</b> The 6 GHz frequency is supported on computers that are installed with the Windows 11 operating system only.</p>	<p><b>i</b> <b>NOTE:</b> The 6 GHz frequency is supported on computers that are installed with the Windows 11 operating system only.</p>
Wireless standards	<ul style="list-style-type: none"> <li>• WiFi 802.11a/b/g</li> <li>• Wi-Fi 4 (WiFi 802.11n)</li> <li>• Wi-Fi 5 (WiFi 802.11ac)</li> <li>• Wi-Fi 6E (WiFi 802.11ax)</li> </ul>	<ul style="list-style-type: none"> <li>• WiFi 802.11a/b/g</li> <li>• Wi-Fi 4 (WiFi 802.11n)</li> <li>• Wi-Fi 5 (WiFi 802.11ac)</li> <li>• Wi-Fi 6E (WiFi 802.11ax)</li> </ul>
Encryption	<ul style="list-style-type: none"> <li>• 64-bit/128-bit WEP</li> <li>• AES-CCMP</li> <li>• TKIP</li> </ul>	<ul style="list-style-type: none"> <li>• 64-bit and 128-bit WEP</li> <li>• AES-CCMP</li> <li>• TKIP</li> </ul>
Bluetooth wireless card	5.3	5.3
	<p><b>i</b> <b>NOTE:</b> The version of the Bluetooth wireless card may vary depending on the operating system that is installed on your computer.</p>	

## Audio

The following table lists the audio specifications of your Precision 3280 CFF.

**Table 12. Audio specifications**

Description	Values	
Audio controller	Realtek ALC3204	
Stereo conversion	24-bit DAC (Digital-to-Analog) and ADC (Analog-to-Digital)	
Internal audio interface	Intel HDA (high-definition audio)	
External audio interface	One Universal Audio port	
Number of speakers	One (optional)	
Internal-speaker amplifier	Integrated in ALC3204 (Class-D 2 W)	
External volume controls	Keyboard shortcut controls	
Speaker output:		
	Average speaker output	2 W
	Peak speaker output	2.2 W
Subwoofer output	Not supported	
Microphone	Not supported	

# Storage

This section lists the storage options on your Precision 3280 CFF.

- M.2 SSD Boot + Optional M.2 SSDs – This configuration enables boot on M.2 NVMe SSD with up to an additional NVMe SSD. No SATA hard drive are configured in this option.
- M.2 SSD storage on slot 2 requires a heat-sink.
- RAID 0/1 available.

**Table 13. Storage specifications**

Storage type	Interface type	Capacity
M.2 2280 SSD	Gen 4 PCIe NVMe, Class 35	256 GB
M.2 2280 SSD	Gen 4 PCIe NVMe, Class 40	Up to 4 TB
M.2 2280 Opal Self-Encrypting SSD	Gen 4 PCIe NVMe, Class 40	Up to 1 TB

# Storage matrix

The following table lists the storage configurations that are supported on your Precision 3280 CFF.

**Table 14. Storage matrix**

Configuration ID	Configuration	M.2 Slot on System board	Second M.2 Slot on System board
1	Internal M.2 SSD Boot	Yes	No
2	Internal M.2 SSD Boot   Optional SSD	Yes	Yes
3	Internal M.2 SSD Boot   Optional SSD	Yes	Yes
4	Internal M.2 SSD Boot   Optional SSD	RAID 0 or 1	RAID 0 or 1
5	Internal M.2 SSD Boot   Optional SSD	RAID 0 or 1	RAID 0 or 1

**NOTE:** M.2 SSD storage on slot 2 requires a heat-sink.

# RAID (Redundant Array of Independent Disks)

For optimal performance when configuring drives as a RAID volume, Dell Technologies recommends drive models that are identical.

**NOTE:** RAID is not supported on Intel Optane configurations.

RAID 0 (Striped, Performance) volumes benefit from higher performance when drives are matched because the data is split across multiple drives: any I/O operations with block sizes larger than the stripe size splits the I/O and become constrained by the slowest of the drives. For RAID 0 I/O operations where block sizes are smaller than the stripe size, whichever drive the I/O operation targets determine the performance, which increases variability and results in inconsistent latencies. This variability is particularly pronounced for write operations, and it can be problematic for applications that are latency sensitive. One such example of this is any application that performs thousands of random writes per second in small block sizes.

RAID 1 (Mirrored, Data Protection) volumes benefit from higher performance when drives are matched because the data is mirrored across multiple drives: all I/O operations must be performed identically to both drives, thus variations in drive performance when the models are different, results in the I/O operations completing only as fast as the slowest drive. While this does not suffer the variable latency issue in small random I/O operations as with RAID 0 across heterogeneous drives, the impact is nonetheless large because the higher performing drive becomes limited in all I/O types. One of the worst examples of constrained performance here is when using unbuffered I/O. To ensure that writes are fully committed to nonvolatile regions of the RAID volume, unbuffered I/O bypasses cache (for example by using the Force Unit Access bit in the NVMe protocol) and



the I/O operation will not complete until all the drives in the RAID volume have completed the request to commit the data. This kind of I/O operation completely negates any advantage of a higher performing drive in the volume.

Care must be taken to match not only the drive vendor, capacity, and class, but also the specific model. Drives from the same vendor, with the same capacity, and even within the same class, can have different performance characteristics for certain types of I/O operations. Thus, matching by model ensures that the RAID volume is comprised of a homogeneous array of drives that deliver all the benefits of a RAID volume without incurring the additional penalties when one or more drives in the volume are lower performing.

Precision 3280 CFF supports RAID with more than one hard drive configuration.

## Power adapter

The following table lists the power adapter specifications of your Precision 3280 CFF.

**Table 15. Power adapter specifications**

Description	Option one	Option two
Type	180 W AC adapter	280 W AC adapter
Connector dimensions:		
External diameter	7.40 mm (0.29 in.)	7.40 mm
Internal diameter	5.10 mm (0.20 in.)	5.10 mm
Input voltage	100 VAC - 240 VAC	100-120 VAC; 200-240 VAC
Input frequency	50 Hz–60 Hz	50 Hz–60 Hz
Input current (maximum)	2.34 A	4 A
Output current (continuous)	9.23 A	14.36 A
Rated output voltage	19.50 VDC	19.50 VDC
Temperature range:		
Operating	0°C-40°C (32°F-104°F)	0°C-40°C (32°F-104°F)
Storage	-40°C-70°C (-40°F-158°F)	-40°C-70°C (-40°F-158°F)
 <b>CAUTION: Operating and storage temperature ranges may differ among components, so operating or storing the device outside these ranges may impact the performance of specific components.</b>		

## GPU—Integrated

The following table lists the specifications of the integrated Graphics Processing Unit (GPU) supported by your Precision 3280 CFF.

**Table 16. GPU—Integrated**

Controller	Memory size	Processor
Intel UHD Graphics 730	Shared system memory	Intel Core i3-14100
Intel UHD Graphics 770	Shared system memory	Intel Core i5-14500 vPro, i5-14600 vPro, i7-14700 vPro, and i9-14900 vPro processors

## Multiple display support matrix

The following table lists the multiple display support matrix for your Precision 3280 CFF.

**Table 17. Multiple display support matrix**

Description	Option 1	Option 2
Integrated Graphics Card	UHD Graphics 730 with 3 Display Port	UHD Graphics 770 with 3 Display Port
Optional Module	<ul style="list-style-type: none"> <li>Optional card with VGA (1920 x 1200 @ 60 Hz)</li> <li>Optional card with DP 1.4a (HBR3) (5120 x 3200 @ 60 Hz)</li> <li>Optional card with HDMI 2.1 (4096 x 2160 @ 60 Hz)</li> <li>Optional card with Type-C (5120 x 3200 @ 60 Hz)</li> </ul>	<ul style="list-style-type: none"> <li>Optional card with VGA (1920 x 1200 @ 60 Hz)</li> <li>Optional card with DP 1.4a (HBR3) (5120 x 3200 @ 60 Hz)</li> <li>Optional card with HDMI 2.1 (4096 x 2160 @ 60 Hz)</li> <li>Optional card with Type-C (5120 x 3200 @ 60 Hz)</li> </ul>
Supported 4K Displays	DP1.4a HBR2, 4096 x 2304 @ 60 Hz	DP1.4a HBR2, 4096 x 2304 @ 60 Hz
Supported 5K Displays	5K tiled resolution (5120x2880) support on DP panels. <i>i</i> <b>NOTE:</b> Requires two DP cables driven through two separate DDIs from the source, and using DP-SST (Single Stream Transport) mechanism.	5K tiled resolution (5120x2880) support on DP panels. <i>i</i> <b>NOTE:</b> Requires two DP cables driven through two separate DDIs from the source, and using DP-SST (Single Stream Transport) mechanism.

## GPU—Discrete

The following table lists the specifications of the discrete Graphics Processing Unit (GPU) supported by your Precision 3280 CFF.

**Table 18. GPU—Discrete**

Controller	Memory size	Memory type
NVIDIA RTX 4000 SFF Ada Generation	20 GB	GDDR6
NVIDIA RTX 2000 Ada Generation	16 GB	GDDR6
NVIDIA T1000 <i>i</i> <b>NOTE:</b> NVIDIA T1000 graphics card requires Fan duct installation.	8 GB	GDDR6
NVIDIA T400	4 GB	GDDR6







## Video port resolution

The following table lists the video port resolution for your Precision 3280 CFF.

**Table 19. Video port resolution**

Graphics card	Video ports	Maximum supported resolution
NVIDIA RTX 4000 SFF Ada Generation	Four DP 1.4 ports	7680 x 4320 @24 bpp at 120 Hz <i>i</i> <b>NOTE:</b> Requires two DPs 1.4a and DSC

**Table 19. Video port resolution (continued)**

Graphics card	Video ports	Maximum supported resolution
		 <b>NOTE:</b> DisplayPort 1.2 Certified, DisplayPort 1.3 and 1.4 ready
NVIDIA RTX 2000 Ada Generation	Four mini-DP 1.4 ports	7680 x 4320 @24 bpp at 120 Hz  <b>NOTE:</b> Requires two DPs 1.4a and DSC  <b>NOTE:</b> DisplayPort 1.2 Certified, DisplayPort 1.3 and 1.4 ready
NVIDIA T1000	Four mini-DP 1.4 ports	7680 x 4320 @24 bpp at 120 Hz  <b>NOTE:</b> Requires three DPs 1.4a and DSC  <b>NOTE:</b> DisplayPort 1.2 Certified, DisplayPort 1.3 and 1.4 ready
NVIDIA T400	Three mini-DP 1.4 ports	7680 x 4320 @24 bpp at 120 Hz  <b>NOTE:</b> Requires two DPs 1.4a and DSC  <b>NOTE:</b> DisplayPort 1.2 Certified, DisplayPort 1.3 and 1.4 ready

## Hardware security

The following table lists the hardware security of your Precision 3280 CFF.

**Table 20. Hardware security**

Hardware security
Kensington security-cable slot
Padlock loop
Chassis intrusion switch
Chassis lock slot support
Lockable cable covers
Supply chain tamper alerts
SafelD including Trusted Platform Module (TPM) 2.0
Smart card keyboard (FIPS)
Microsoft 10 Device Guard and Credential Guard (Enterprise SKU)
Microsoft Windows Bitlocker
Local hard drive data wipe through BIOS (Secure Erase)
Self-encrypting storage drives (Opal, FIPS)
Trusted Platform Module TPM 2.0
China TPM

**Table 20. Hardware security (continued)**

Hardware security
Intel Secure Boot
Intel Authenticate
SafeBIOS: includes Dell Off-host BIOS
Verification, BIOS Resilience, BIOS
Recovery, and additional BIOS Controls

## Environmental

The following table lists the environmental specifications of your Precision 3280 CFF.

**Table 21. Environmental**

Feature	Values
Recyclable packaging	Yes
BFR/PVC—free	No
Vertical orientation packaging support	Yes
MultiPack packaging	Yes (Except Brazil)
Energy-Efficient Power Supply	Standard
ENV0424 compliant	Yes

**NOTE:** Wood-based fiber packaging contains a minimum of 35% recycled content by total weight of wood-based fiber. Packaging that contains without wood-based fiber can be claimed as Not Applicable. The anticipated required criteria for EPEAT 2018.

## Regulatory compliance

The following table lists the regulatory compliance of your Precision 3280 CFF.

**Table 22. Regulatory compliance**

Regulatory compliance
<a href="#">Product Safety, EMC and Environmental Datasheets</a>
<a href="#">Dell Regulatory Compliance Home page</a>
<a href="#">Responsible Business Alliance Policy</a>

## Operating and storage environment

This table lists the operating and storage specifications of your Precision 3280 CFF.

**Airborne contaminant level:** G1 as defined by ISA-S71.04-1985

**Table 23. Computer environment**

Description	Operating	Storage
Temperature range	10°C-35°C (50°F-95°F)	-40°C-65°C (-40°F-149°F)
Relative humidity (maximum)	20% to 85% (non-condensing) (non-condensing, Max dew point temperature = 26°C)	0% to 95% (non-condensing) 5% to 95% (non-condensing, Max dew point temperature = 33°C)
Vibration (maximum)*	0.52 GRMS random at 5 Hz-350 Hz	2.0 GRMS random at 5 Hz-500 Hz
Shock (maximum)	40G Bottom half-sine pulse (2.5 ms)	105G half-sine pulse (2.5 ms)
Altitude range	-15.2 m to 3048 m (4.64 ft to 10,000 ft)	-15.2 m to 10,668 m (4.64 ft to 35,000 ft)
 <b>CAUTION: Operating and storage temperature ranges may differ among components, so operating or storing the device outside these ranges may impact the performance of specific components.</b>		

\* Measured using a random vibration spectrum that simulates the user environment.

† Measured using a 2 ms half-sine pulse.

## Dell support policy

For information about Dell support policy, search in the Knowledge Base Resource at [Dell Support Site](#).

## Dell Optimizer

This section details the Dell Optimizer specifications of your Precision 3280 CFF.

On Precision 3280 CFF with Dell Optimizer, the following features are supported:











- **Express Connect**—Automatically joins the access point with the strongest signal, and directs bandwidth to conferencing applications when in use.
- **ExpressResponse**—Prioritizes the most important applications. Applications open faster and perform better.
- **AudioOptimization**—The audio feature enhances the audio functionality during your online meetings. The audio feature helps filter the background noise, stabilize volume, and prioritize preferred voice streaming during online meetings.

For more information about configuring and using these features, see [Dell Optimizer User Guide](#).

# Working inside your computer

## Safety instructions

Use the following safety guidelines to protect your computer from potential damage and to ensure your personal safety. Unless otherwise noted, each procedure in this document assumes that you have read the safety information that shipped with your computer.



-  **WARNING:** Before working inside your computer, read the safety information that is shipped with your computer. For more safety best practices, see [Dell Regulatory Compliance Home Page](#).
-  **WARNING:** Disconnect your computer from all power sources before opening the computer cover or panels. After you finish working inside the computer, replace all covers, panels, and screws before connecting your computer to an electrical outlet.
-  **CAUTION:** To avoid damaging the computer, ensure that the work surface is flat, dry, and clean.
-  **CAUTION:** To avoid damaging the components and cards, handle them by their edges, and avoid touching the pins and the contacts.
-  **CAUTION:** You should only perform troubleshooting and repairs as authorized or directed by the Dell technical support team. Damage due to servicing that is not authorized by Dell is not covered by your warranty. See the safety instructions that is shipped with the product or at [Dell Regulatory Compliance Home Page](#).
-  **CAUTION:** Before touching anything inside your computer, ground yourself by touching an unpainted metal surface, such as the metal at the back of the computer. While you work, periodically touch an unpainted metal surface to dissipate static electricity which could harm internal components.
-  **CAUTION:** When you disconnect a cable, pull it by its connector or its pull tab, not the cable itself. Some cables have connectors with locking tabs or thumbscrews that you must disengage before disconnecting the cable. When disconnecting cables, keep them evenly aligned to avoid bending the connector pins. When connecting cables, ensure that the connector on the cable is correctly oriented and aligned with the port.
-  **CAUTION:** Press and eject any installed card from the media-card reader.
-  **CAUTION:** Exercise caution when handling rechargeable Li-ion batteries in laptops. Swollen batteries should not be used and should be replaced and disposed properly.
-  **NOTE:** The color of your computer and certain components may differ from what is shown in this document.

## Before working inside your computer

### About this task

-  **NOTE:** The images in this document may differ from your computer depending on the configuration you ordered.

### Steps

1. Save and close all open files and exit all open applications.
2. Shut down your computer. For Windows operating system, click **Start** >  **Power** > **Shut down**.
  -  **NOTE:** If you are using a different operating system, see the documentation of your operating system for shut-down instructions.

3. Disconnect your computer and all attached devices from their electrical outlets.
4. Disconnect all attached network devices and peripherals, such as keyboard, mouse, and monitor from your computer.

 **CAUTION: To disconnect a network cable, first unplug the cable from your computer and then unplug the cable from the network device.**

5. Remove any media card and optical disc from your computer, if applicable.

## Safety precautions

The safety precautions section details the primary steps to be taken before performing any disassembly instructions.

Observe the following safety precautions before you perform any installation or break-fix procedures involving disassembly or reassembly:

- Turn off the computer and all attached peripherals.
- Disconnect the computer from AC power.
- Disconnect all network cables and peripherals from the computer.
- Use an ESD field service kit when working inside any desktop to avoid electrostatic discharge (ESD) damage.
- After removing a computer component, carefully place the removed component on an anti-static mat.
- Wear shoes with non-conductive rubber soles to reduce the chance of getting electrocuted.
- Unplugging, pressing, and holding the power button for 15 seconds should discharge residual power in the system board.

## Standby power

Dell products with standby power must be unplugged before you open the case. Systems equipped with standby power are powered while turned off. The internal power enables the computer to be remotely turned on (Wake-on-LAN) and suspended into a sleep mode and has other advanced power management features.

## Bonding

Bonding is a method for connecting two or more grounding conductors to the same electrical potential. This is done by using a field service electrostatic discharge (ESD) kit. When connecting a bonding wire, ensure that it is connected to bare metal and never to a painted or nonmetal surface. Ensure that the wrist strap is secure and in full contact with your skin. Remove all jewelry such as watches, bracelets, or rings before to grounding yourself and the equipment.

## Electrostatic discharge—ESD protection

ESD is a major concern when you handle electronic components, especially sensitive components such as expansion cards, processors, memory modules, and system boards. A slight charge can damage circuits in ways that may not be obvious, such as intermittent problems or a shortened product life span. As the industry pushes for lower power requirements and increased density, ESD protection is an increasing concern.

Due to the increased density of semiconductors used in recent Dell products, the sensitivity to static damage is now higher than in previous Dell products. For this reason, some previously approved methods of handling parts are no longer applicable.

Two recognized types of ESD damage are catastrophic and intermittent failures.

- **Catastrophic** – Catastrophic failures represent approximately 20 percent of ESD-related failures. The damage causes an immediate and complete loss of device functionality. An example of catastrophic failure is a memory module that has received a static shock and immediately generates a "No POST/No Video" symptom with a beep code that is emitted for missing or non-functional memory.
- **Intermittent** – Intermittent failures represent approximately 80 percent of ESD-related failures. The high rate of intermittent failures means that most of the time when damage occurs, it is not immediately recognizable. The memory module receives a static shock, but the tracing is merely weakened and does not immediately produce outward symptoms that are related to the damage. The weakened trace may take weeks or months to melt, and in the meantime may cause degradation of memory integrity, intermittent memory errors, and so on.

Intermittent failures also called latent or "walking wounded" are difficult to detect and troubleshoot.

Perform the following steps to prevent ESD damage:

- Use a wired ESD wrist strap that is properly grounded. Wireless anti-static straps do not provide adequate protection. Touching the chassis before handling parts does not ensure adequate ESD protection on parts with increased sensitivity to ESD damage.
- Handle all static-sensitive components in a static-safe area. If possible, use anti-static floor pads and workbench pads.
- When unpacking a static-sensitive component from its shipping carton, do not remove the component from the anti-static packing material until you are ready to install the component. Before unwrapping the anti-static packaging, use the anti-static wrist strap to discharge the static electricity from your body.
- Before transporting a static-sensitive component, place it in an anti-static container or packaging.

## ESD Field Service kit

The unmonitored Field Service kit is the most commonly used service kit. Each Field Service kit includes three main components: anti-static mat, wrist strap, and bonding wire.

 **CAUTION: It is critical to keep ESD-sensitive devices away from internal parts that are insulators and often highly charged, such as plastic heat sink casings.**

## Working Environment

Before deploying the ESD Field Service kit, assess the situation at the customer location. For example, deploying the kit for a server environment is different than for a desktop or laptop environment. Servers are typically installed in a rack within a data center; desktops or laptops are typically placed on office desks or cubicles. Always look for a large open flat work area that is free of clutter and large enough to deploy the ESD kit with additional space to accommodate the type of computer that is being repaired. The workspace should also be free of insulators that can cause an ESD event. On the work area, insulators such as Styrofoam and other plastics should always be moved at least 12 inches or 30 centimeters away from sensitive parts before physically handling any hardware components.

## ESD Packaging

All ESD-sensitive devices must be shipped and received in static-safe packaging. Metal, static-shielded bags are preferred. However, you should always return the damaged part using the same ESD bag and packaging that the new part arrived in. The ESD bag should be folded over and taped shut and all the same foam packing material should be used in the original box that the new part arrived in. ESD-sensitive devices should be removed from packaging only at an ESD-protected work surface, and parts should never be placed on top of the ESD bag because only the inside of the bag is shielded. Always place parts in your hand, on the ESD mat, in the computer, or inside an anti-static bag.

## Components of an ESD Field Service kit

The components of an ESD Field Service kit are:

- **Anti-Static Mat** – The anti-static mat is dissipative and parts can be placed on it during service procedures. When using an anti-static mat, your wrist strap should be snug and the bonding wire should be connected to the anti-static mat and to any bare metal on the computer being worked on. Once deployed properly, service parts can be removed from the ESD bag and placed directly on the anti-static mat. ESD-sensitive items are safe in your hand, on the anti-static mat, in the computer, or inside an ESD bag.
- **Wrist Strap and Bonding Wire** – The wrist strap and bonding wire can be either directly connected between your wrist and bare metal on the hardware if the ESD mat is not required, or connected to the anti-static mat to protect hardware that is temporarily placed on the mat. The physical connection of the wrist strap and bonding wire between your skin, the ESD mat, and the hardware is known as bonding. Use only Field Service kits with a wrist strap, anti-static mat, and bonding wire. Never use wireless wrist straps. Always be aware that the internal wires of a wrist strap are prone to damage from normal wear and tear, and must be checked regularly with a wrist strap tester in order to avoid accidental ESD hardware damage. It is recommended to test the wrist strap and bonding wire at least once per week.
- **ESD Wrist Strap Tester** – The wires inside an ESD strap are prone to damage over time. When using an unmonitored kit, it is a best practice to regularly test the strap prior to each service call, and at a minimum, test once per week. A wrist strap tester is the best method for doing this test. If you do not have your own wrist strap tester, check with your regional office to find out if they have one. To perform the test, plug the bonding-wire of the wrist-strap into the tester while it is strapped to your wrist and push the button to test. A green LED is lit if the test is successful; a red LED is lit and an alarm sounds if the test fails.



 **NOTE:** It is recommended to always use the traditional wired ESD grounding wrist strap and protective anti-static mat when servicing Dell products. In addition, it is critical to keep sensitive parts separate from all insulator parts while servicing the computer, and use anti-static bags for transporting sensitive components.

## Transporting sensitive components

When transporting ESD sensitive components such as replacement parts or parts to be returned to Dell, it is critical to place these parts in anti-static bags for safe transport.

## Lifting equipment

Adhere to the following guidelines when lifting heavy equipment:

 **CAUTION: Do not lift greater than 50 pounds. Always obtain additional resources or use a mechanical lifting device.**

1. Get a firm balanced footing. Keep your feet apart for a stable base, and point your toes out.
2. Tighten stomach muscles. Abdominal muscles support your spine when you lift, offsetting the force of the load.
3. Lift with your legs, not your back.
4. Keep the load close. The closer it is to your spine, the less force it exerts on your back.
5. Keep your back upright, whether lifting or setting down the load. Do not add the weight of your body to the load. Avoid twisting your body and back.
6. Follow the same technique in reverse to set the load down.

## After working inside your computer

### About this task

 **CAUTION: Leaving stray or loose screws inside your computer may severely damage your computer.**

### Steps

1. Replace all screws and ensure that no stray screws remain inside your computer.
2. Connect any external devices, peripherals, or cables you removed before working on your computer.
3. Replace any media cards, discs, or any other parts that you removed before working on your computer.
4. Connect your computer and all attached devices to their electrical outlets.
5. Turn on your computer.

## BitLocker

 **CAUTION: If BitLocker is not suspended before updating the BIOS, the BitLocker key is not recognized the next time you reboot the computer. You will then be prompted to enter the recovery key to progress, and the system displays a prompt for the recovery key on each reboot. If the recovery key is not known, this can result in data loss or an operating system reinstall. For more information, see Knowledge Article: [updating the BIOS on Dell systems with BitLocker enabled](#).**

The installation of the following components triggers BitLocker:

- Hard disk drive or solid-state drive
- System board

## Recommended tools

The procedures in this document may require the following tools:

- Phillips screwdriver #0

- Phillips screwdriver #1
- Plastic scribe









## Screw list

**NOTE:** When removing screws from a component, it is recommended to note the screw type and the quantity of screws, and then place them in a screw storage box. This is to ensure that the correct number of screws and correct screw type is restored when the component is replaced.

**NOTE:** Some computers have magnetic surfaces. Ensure that the screws are not left attached to such surfaces when replacing a component.

**NOTE:** Screw color may vary depending on the configuration ordered.

**Table 24. Screw list**

Component	Screw type	Quantity	Screw image
Side cover	#6-32	1	
Riser-card module	M3x3	2	
M.2 2230 SSD (slot-1/slot-2)	M2x3.5	2	
M.2 2280 SSD (slot-1/slot-2)	M2x3.5	1	
WLAN card	M2x3.5	2	
System board	M3x5 M3x4 Standoff	4 1	 
Internal Antenna (location-1/ location-2)	M3x3	2	
Option Module	M3x3	2	

## Major components of Precision 3280 CFF

The following image shows the major components of Precision 3280 CFF.

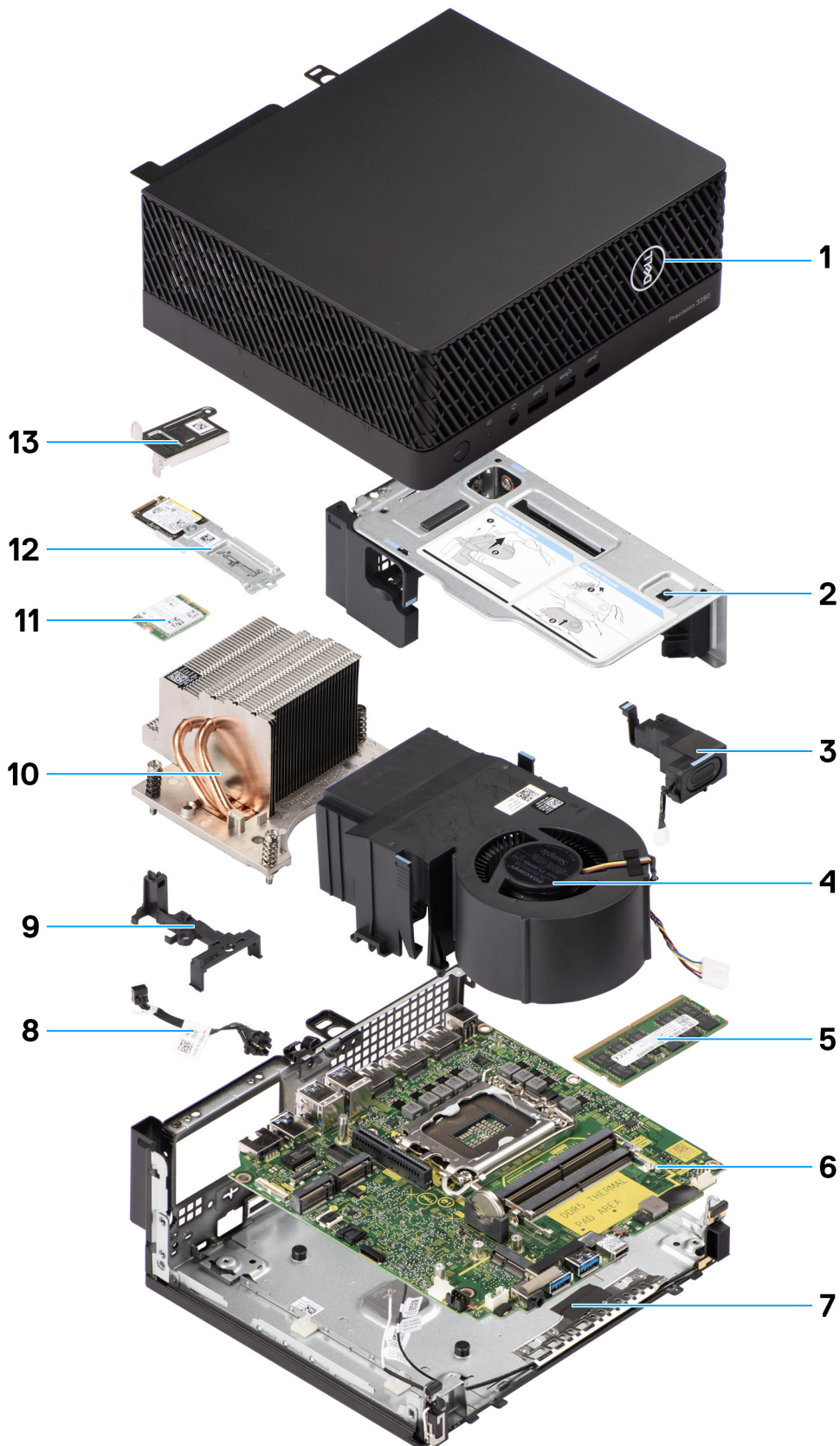

1. Side cover

3. Speaker

5. Memory module

7. Bottom chassis

2. Riser-card bracket

4. Processor fan

6. System board

8. Power button

- 9. Speaker holder
- 11. Wireless card
- 13. Wireless card bracket

- 10. Heat-sink
- 12. M.2 2230 solid-state drive

 **NOTE:** Dell provides a list of components and their part numbers for the original computer configuration purchased. These parts are available according to warranty coverages purchased by the customer. Contact your Dell sales representative for purchase options.

# Removing and installing coin-cell battery

## Removing the coin-cell battery

**⚠ WARNING:** This computer contains a coin-cell battery and requires trained technicians for handling guidance.

**⚠ CAUTION:** Removing the coin-cell battery clears the CMOS and resets BIOS settings.

### Prerequisites

1. Follow the procedure in [before working inside your computer](#).
2. Remove the [side cover](#).
3. Remove the [riser-card module](#).
4. Remove the [speaker](#).

### About this task

The following image indicates the location of the coin-cell battery and provides a visual representation of the removal procedure.

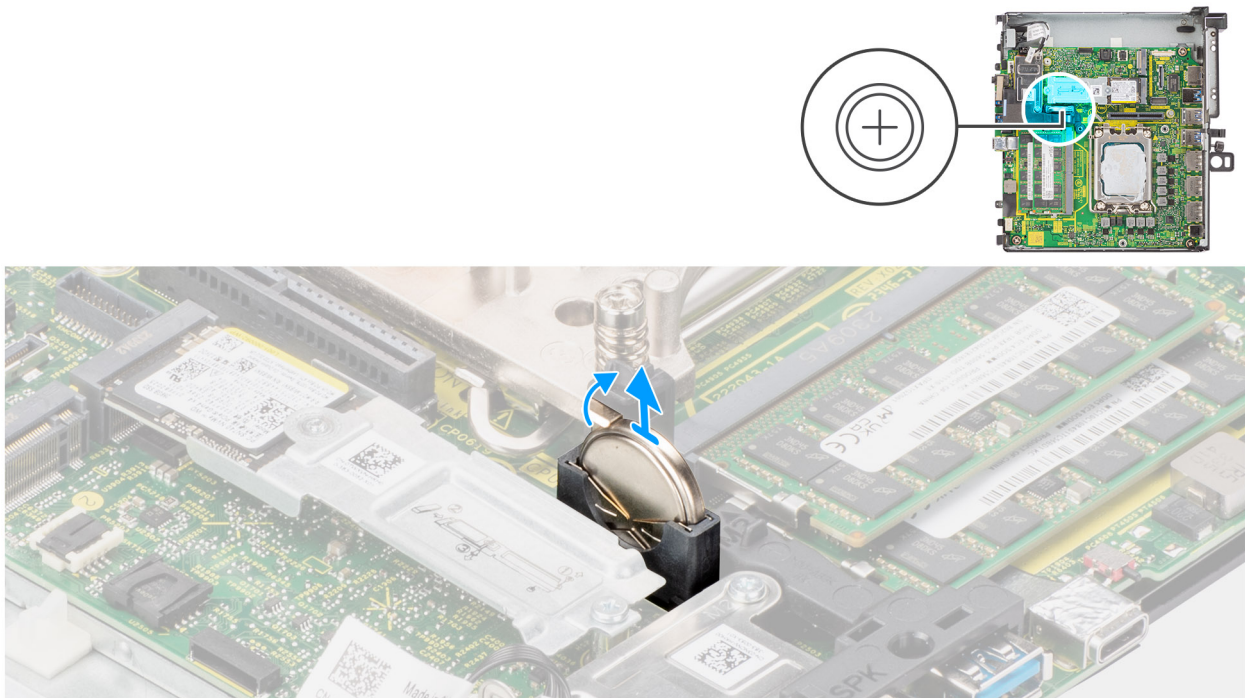

**Figure 8. Removing the coin-cell battery**

### Steps

1. Push the coin-cell battery securing-clip on the coin-cell battery socket to release the coin-cell battery.
2. Remove the coin-cell battery from the system.



# Installing the coin-cell battery

**⚠ WARNING:** This computer contains a coin-cell battery and requires trained technicians for handling guidance.

## Prerequisites

If you are replacing a component, remove the existing component before performing the installation procedure.

## About this task

The following image indicates the location of the coin-cell battery and provides a visual representation of the installation procedure.

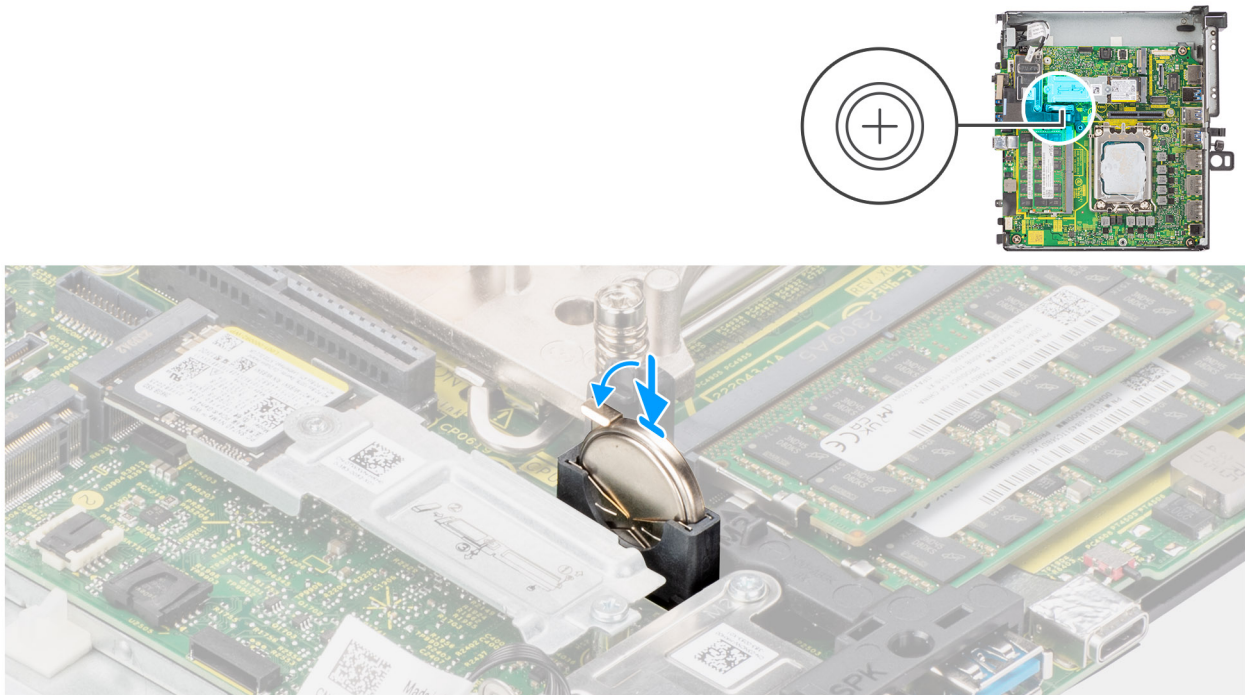

**Figure 9. Installing the coin-cell battery**

## Steps

Insert the coin-cell battery into the socket with the positive side (+) label facing up and snap the battery in the socket.

## Next steps

1. Install the [speaker](#).
2. Install the [riser-card module](#).
3. Install the [side cover](#).
4. Follow the procedure in [after working inside your computer](#).

# Removing and installing Customer Replaceable Units (CRUs)

The replaceable components in this chapter are Customer Replaceable Units (CRUs).

 **CAUTION:** Customers can replace only the Customer Replaceable Units (CRUs) following the safety precautions and replacement procedures.

 **NOTE:** The images in this document may differ from your computer depending on the configuration you ordered.

## Side cover

### Removing the side cover

#### Prerequisites

1. Follow the procedure in [before working inside your computer](#).

 **NOTE:** Ensure that you remove the security cable from the security-cable slot (if applicable).

#### About this task

The following images indicate the location of the side cover and provide a visual representation of the removal procedure.



**1x**  
#6-32



**Figure 10. Removing the side cover**





**Figure 11. Removing the side cover**

**Steps**

1. Loosen the thumbscrew (#6-32) that secures the side cover to the chassis.
2. Slide the side cover towards the front of the system and lift to remove it from the chassis.

## Installing the side cover

**Prerequisites**

If you are replacing a component, remove the existing component before performing the installation procedure.

**About this task**

The following image indicates the location of the side cover and provides a visual representation of the installation procedure.



**1x**  
#6-32



**Figure 12. Installing the side cover**



**Figure 13. Installing the side cover**

**Steps**

1. Align the side cover with the grooves on the chassis.
2. Slide the side cover into the chassis towards the front of the system.
3. Tighten the thumbscrew (#6-32) to secure the side cover to the chassis.

**Next steps**

1. Follow the procedure in [after working inside your computer](#).

## Memory module

### Removing the memory modules

**Prerequisites**

1. Follow the procedure in [before working inside your computer](#).
2. Remove the [side cover](#).

**About this task**

The following images indicate the location of the memory modules and provide a visual representation of the removal procedure.

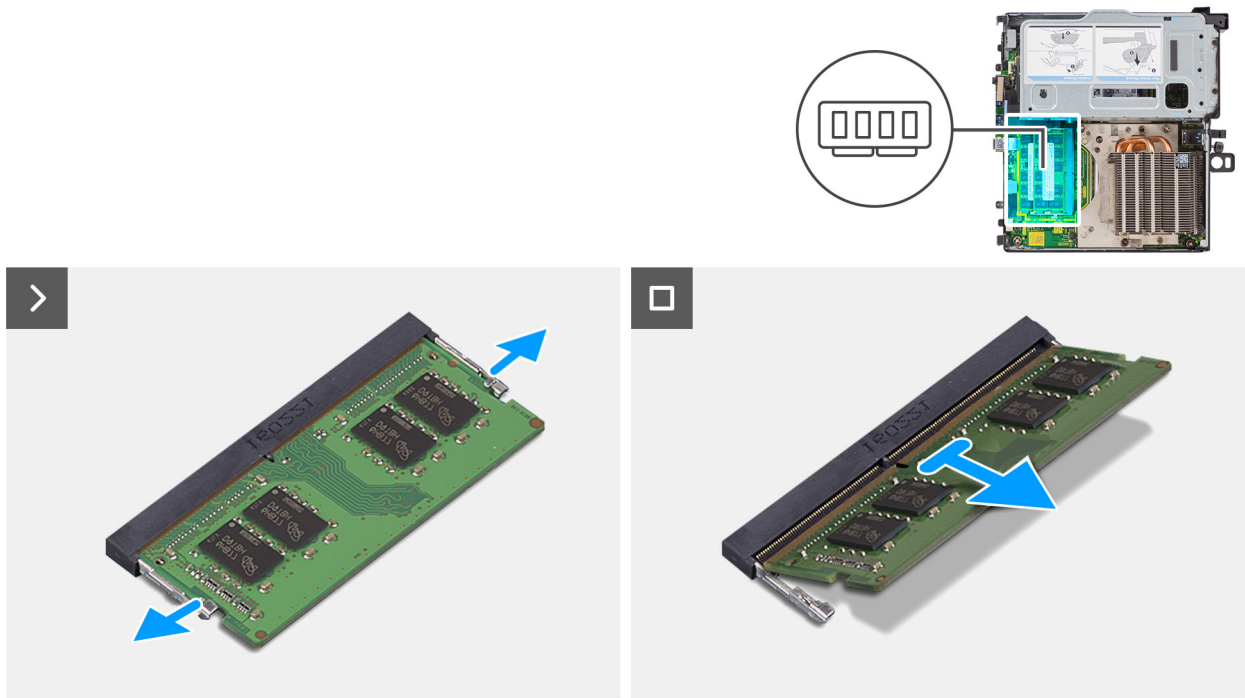

**Figure 14. Removing the memory modules**

**Steps**

1. Place the computer on its side with the left side facing up.
2. Pull the securing clips from both sides of the memory module until the memory module pops up.
3. Slide to remove the memory module from the memory-module slot.

**⚠ CAUTION:** To prevent damage to the memory module, hold the memory module by the edges. Do not touch the components or metallic contacts on the memory module as electrostatic discharge(ESD) can inflict severe damage on the components. To read more about ESD protection, see [ESD protection](#).

**📘 NOTE:** Repeat step 2 to step 3 to remove any other memory module installed in your computer.

**📘 NOTE:** Note the slot and the orientation of the memory module in order to replace it in the correct slot.

## Installing the memory modules

**Prerequisites**

If you are replacing a component, remove the existing component before performing the installation procedure.

**About this task**

The following images indicate the location of the memory modules and provide a visual representation of the installation procedure.

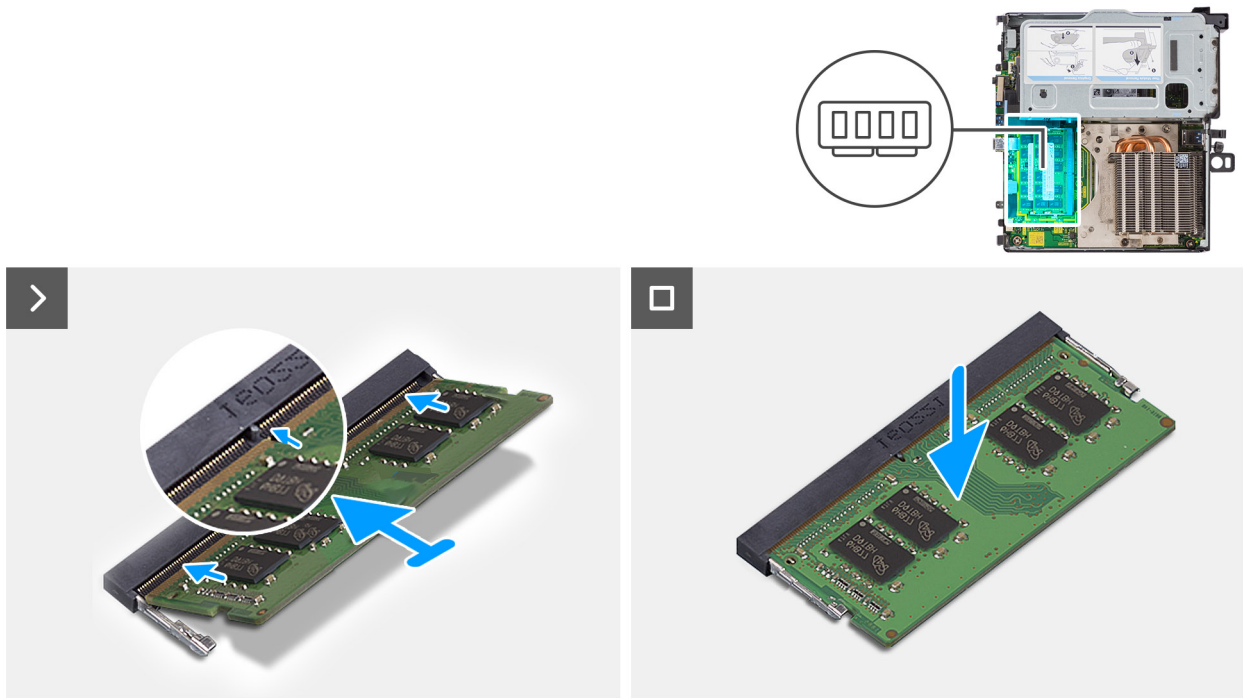

**Figure 15. Installing the memory modules**

**Steps**

1. Align the notch on the memory module with the tab on the memory-module slot.
2. Slide the memory module firmly into the slot at an angle and press the memory module down until it secures into place.

**CAUTION:** To prevent damage to the memory module, hold the memory module by the edges. Do not touch the components or metallic contacts on the memory module as electrostatic discharge(ESD) can inflict severe damage on the components. To read more about ESD protection, see [ESD protection](#).

**NOTE:** The securing clips return to the locked position. If you do not hear the click, remove the memory module and reinstall it.

**NOTE:** Repeat steps 1 to 2 when installing more than one memory module in your computer.

**Next steps**

1. Install the [side cover](#).
2. Follow the procedure in [after working inside your computer](#).

## Riser-card module

### Removing the riser-card module

**Prerequisites**

1. Follow the procedure in [before working inside your computer](#).
2. Remove the [side cover](#).

**About this task**

The following image indicates the location of the riser-card module and provides a visual representation of the removal procedure.





2x  
M3x3

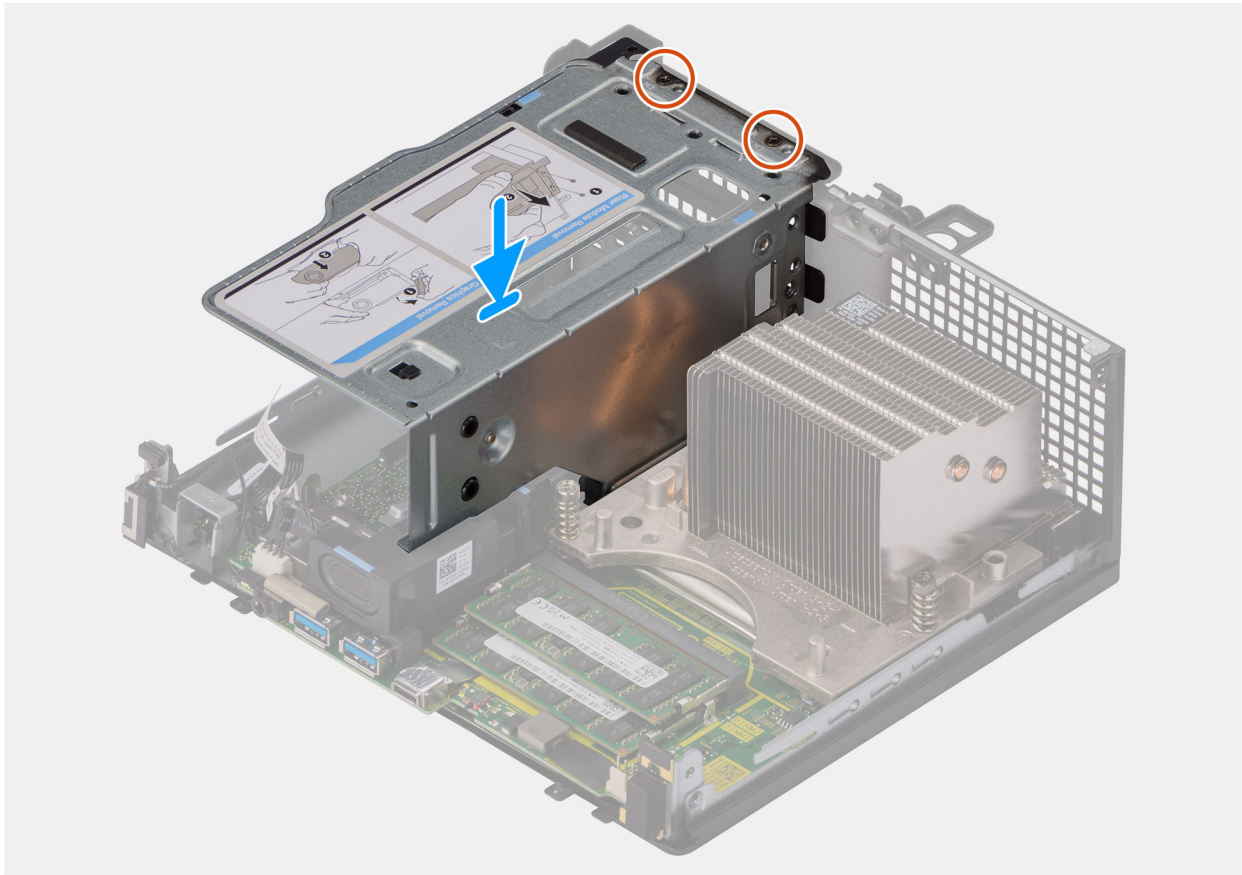
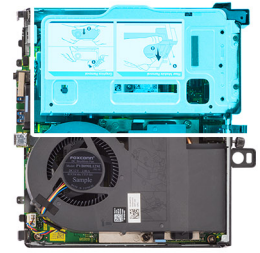

**Figure 16. Removing the riser-card module**

### Steps

1. Remove the two (M3x3) screws that secure the riser-card module to the chassis.
2. Lift the riser-card module away from the computer.

## Installing the riser-card module

### Prerequisites

If you are replacing a component, remove the existing component before performing the installation procedure.

### About this task

The following image indicates the location of the riser-card module and provides a visual representation of the installation procedure.



2x  
M3x3

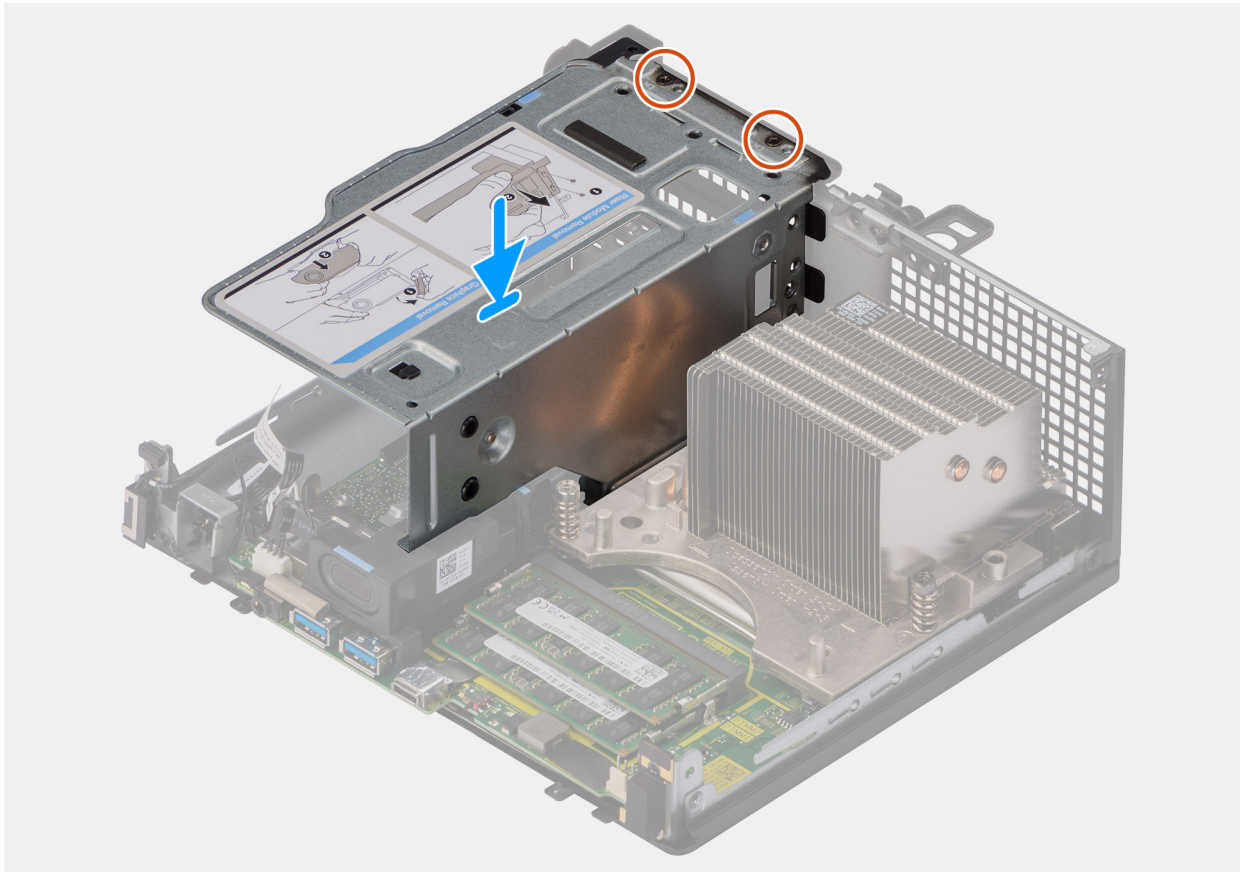
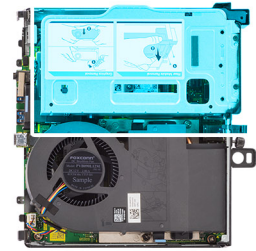

**Figure 17. Installing the riser-card module**

#### Steps

1. Align the screw holes on the riser-card module with the screw holes on the chassis.
2. Replace the two (M3x3) screws to secure the riser-card module to the chassis.

#### Next steps

1. Install the [side cover](#).
2. Follow the procedure in [after working inside your computer](#).

## Solid state drive

### SSD slot 1 and slot 2 cooling matrix

Precision 3280 Compact requires either a bracket or a heat sink for better thermal performance, depending on the SSD configuration. See the table below for appropriate configuration guidelines.

**Table 25. SSD cooling matrix for Precision 3280 Compact**

M.2 SSD type		Heat sink or bracket attachment	
Slot 1	Slot 2	Slot 1	Slot 2
2230		Dummy Bracket	N/A
2280		N/A	N/A
2230	2230	Dummy Bracket	2230 heat sink
2230	2280	Dummy Bracket	2280 heat sink
2280	2230	N/A	2230 heat sink
2280	2280	N/A	2280 heat sink

## Removing the M.2 2230 SSD (slot-1)

### Prerequisites

1. Follow the procedure in [before working inside your computer](#).
2. Remove the [side cover](#).
3. Remove the [riser-card module](#).

### About this task

The following images indicate the location of the SSD and provide a visual representation of the removal procedure.

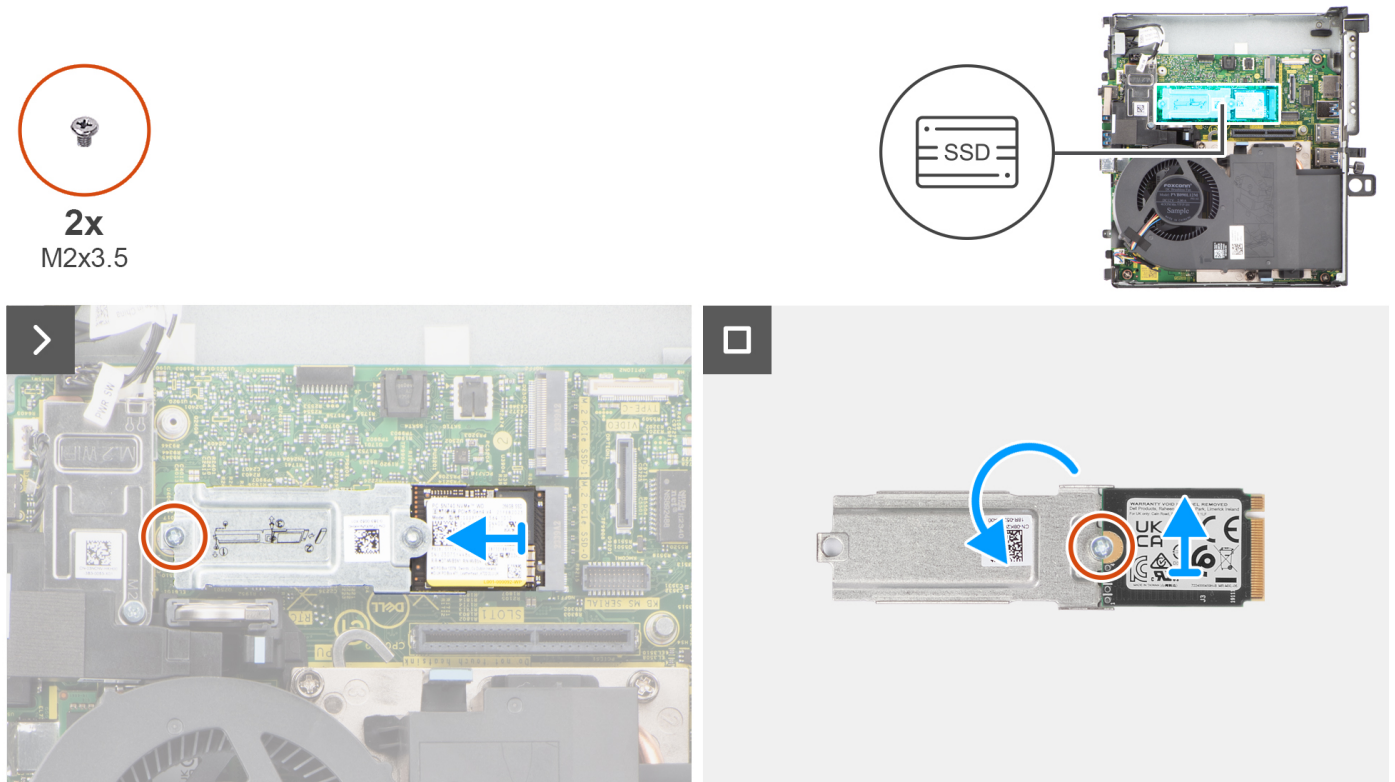

**Figure 18. Removing the M.2 2230 PCIe solid state drive (slot-1)**

### Steps

1. Remove the screw (M2x3.5) that secures the SSD extender bracket to the system board.
2. Slide and lift the SSD extender bracket from the system board.
3. Flip the extender and remove the screw (M2x3.5) that secures the M.2 2230 SSD to the extender bracket.



## Removing the M.2 2230 SSD (slot-2)

### Prerequisites

1. Follow the procedure in [before working inside your computer](#).
2. Remove the [side cover](#).
3. Remove the [riser-card module](#).

### About this task

The following image indicates the location of the SSD and provides a visual representation of the removal procedure.

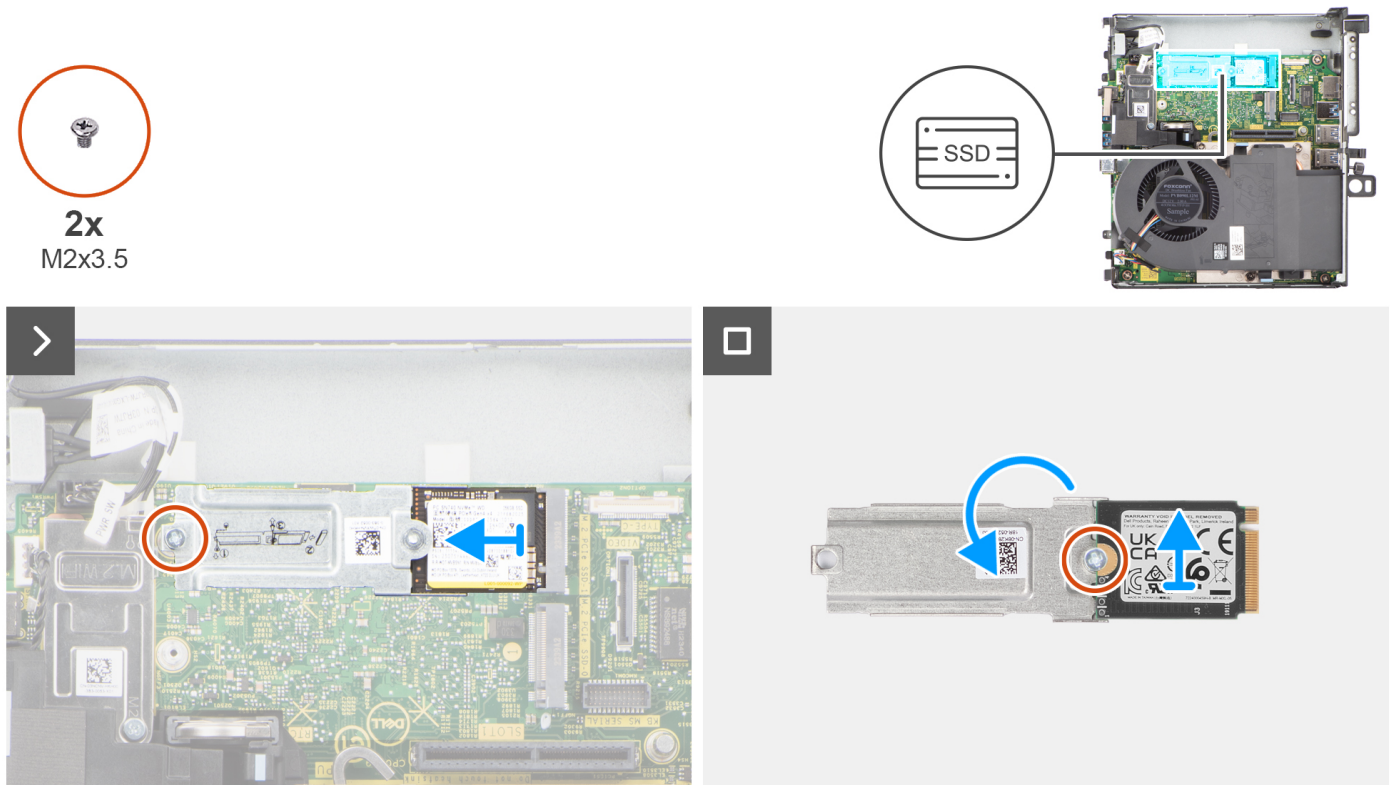

Figure 19. Removing the M.2 2230 PCIe solid state drive (slot-2)

### Steps

1. Remove the screw (M2x3.5) that secures the SSD extender bracket to the system board.
2. Slide and lift the SSD extender bracket from the system board.
3. Flip the extender and remove the screw (M2x3.5) that secures the M.2 2230 SSD to the extender bracket.

## Installing the M.2 2230 SSD (slot-1)

### Prerequisites

If you are replacing a component, remove the existing component before performing the installation procedure.

### About this task

The following image indicates the location of the SSD and provides a visual representation of the installation procedure.



**2x**  
M2x3.5

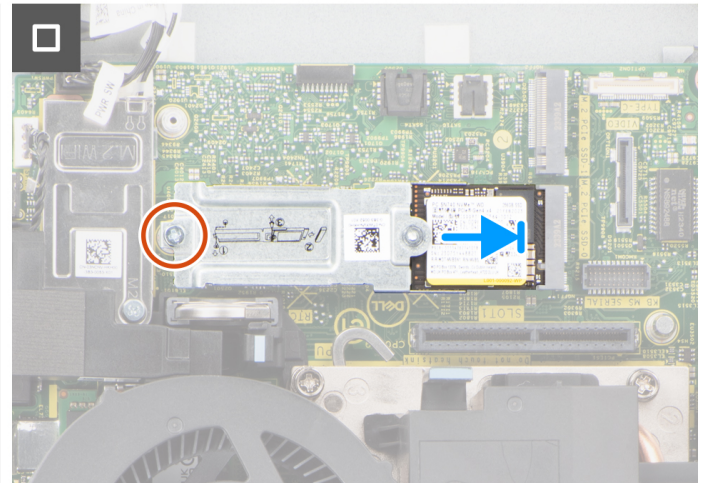
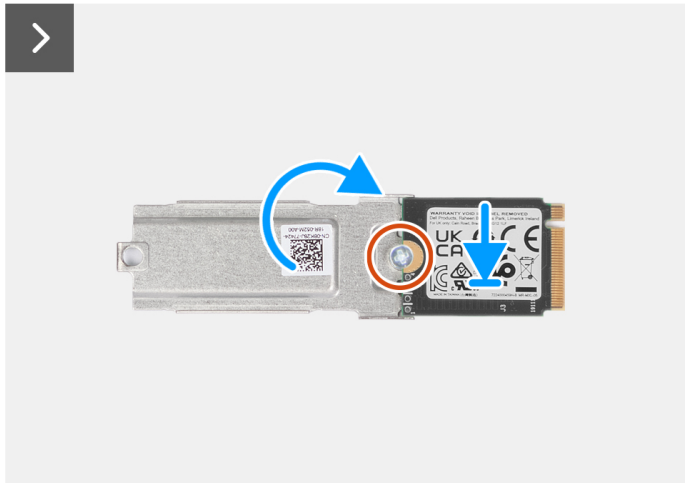
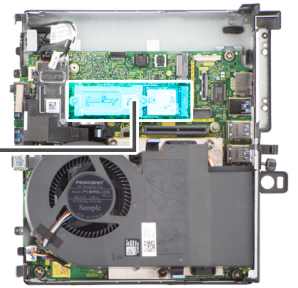
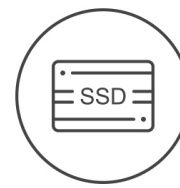

**Figure 20. Installing the M.2 2230 PCIe solid state drive (slot-1)**

### Steps

1. Place the M.2 2230 SSD on the SSD extender bracket.
2. Replace the screw (M2x3.5) that secures the M.2 2230 SSD to the extender bracket.
3. Flip the extender bracket and align the notch with the tab on the SSD connector on the system board.
4. Insert the SSD extender bracket at a 45-degree angle into the M.2 connector on the system board.
5. Replace the screw (M2x3.5) that secures the M.2 2230 SSD extender bracket to the system board.

### Next steps

1. Install the [riser-card module](#).
2. Install the [side cover](#).
3. Follow the procedure in [after working inside your computer](#).

## Installing the M.2 2230 SSD (slot-2)

### Prerequisites

If you are replacing a component, remove the existing component before performing the installation procedure.

### About this task

The following image indicates the location of the SSD and provides a visual representation of the installation procedure.



**2x**  
M2x3.5

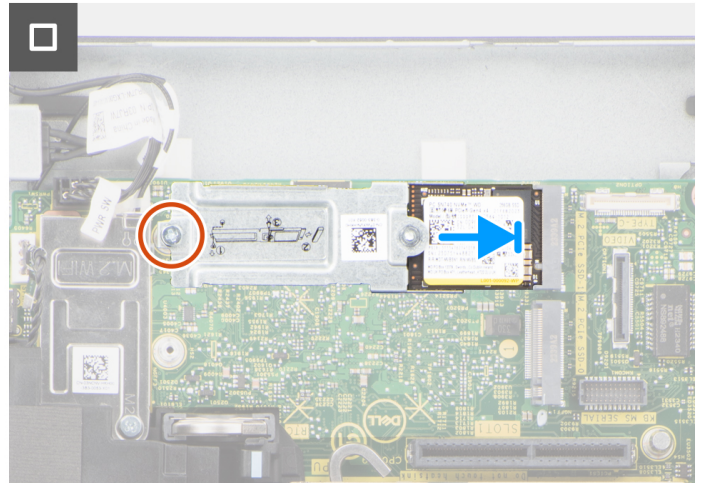
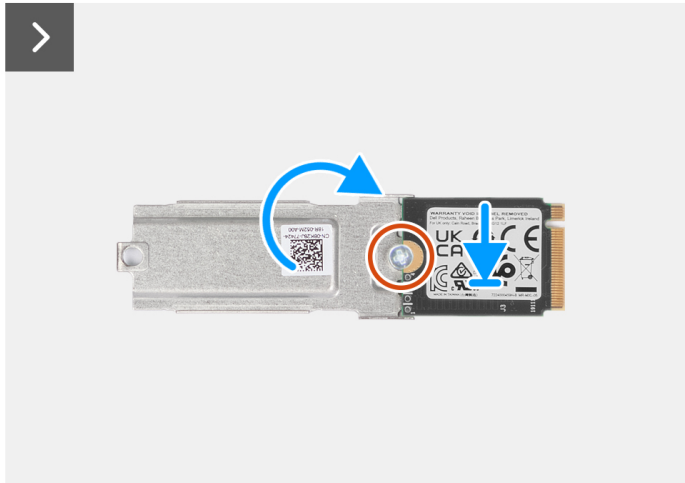
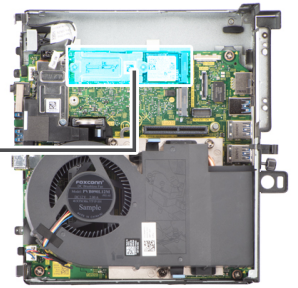
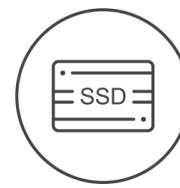

**Figure 21. Installing the M.2 2230 PCIe solid state drive (slot-2)**

### Steps

1. Place the M.2 2230 SSD on the SSD extender bracket.
2. Replace the screw (M2x3.5) that secures the M.2 2230 SSD to the extender bracket.
3. Flip the extender bracket and align the notch with the tab on the SSD connector on the system board.
4. Insert the SSD extender bracket at a 45-degree angle into the M.2 connector on the system board.
5. Replace the screw (M2x3.5) that secures the M.2 2230 SSD extender bracket to the system board.

### Next steps

1. Install the [riser-card module](#).
2. Install the [side cover](#).
3. Follow the procedure in [after working inside your computer](#).

## Removing the M.2 2280 PCIe SSD (slot-1)

### Prerequisites

1. Follow the procedure in [before working inside your computer](#).
2. Remove the [side cover](#).
3. Remove the [riser-card module](#).

### About this task

The following image indicates the location of the SSD and provides a visual representation of the removal procedure.

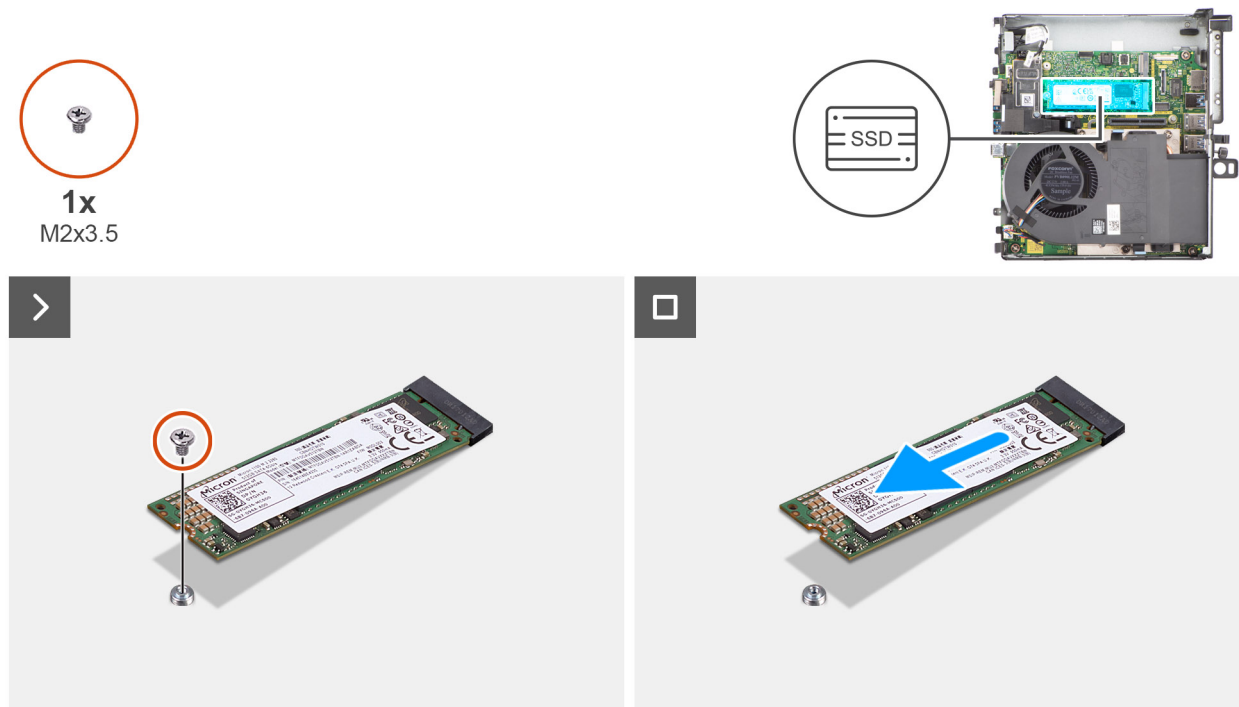

**Figure 22. Removing the M.2 2280 PCIe solid state drive (slot-1)**

**Steps**

1. Remove the screw (M2x3.5) that secures the 2280 SSD to the system board.
2. Slide and lift the 2280 SSD from the M.2 card slot on the system board.

## Removing the M.2 2280 PCIe SSD (slot-2)

**Prerequisites**

1. Follow the procedure in [before working inside your computer](#).
2. Remove the [side cover](#).
3. Remove the [riser-card module](#).

**About this task**

The following image indicates the location of the SSD and provides a visual representation of the removal procedure.

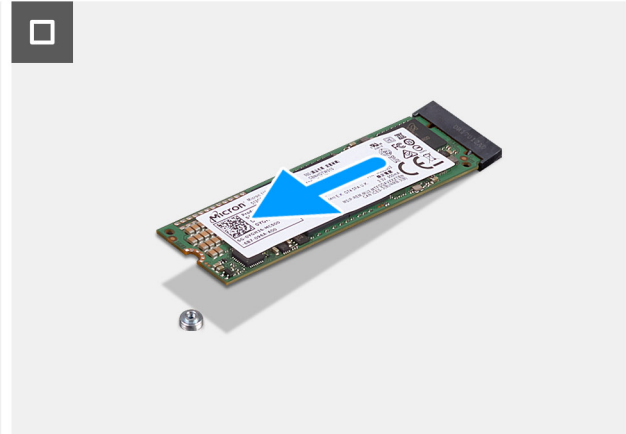
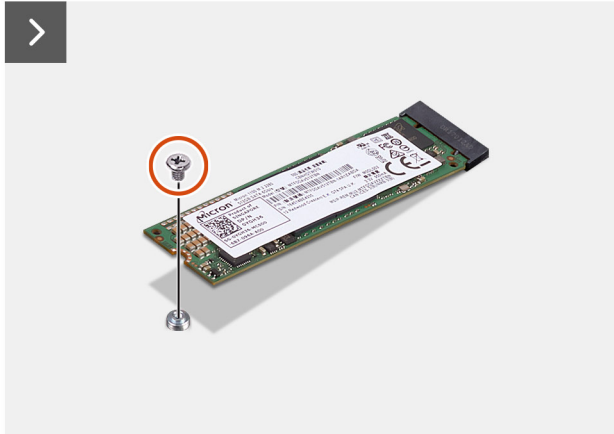
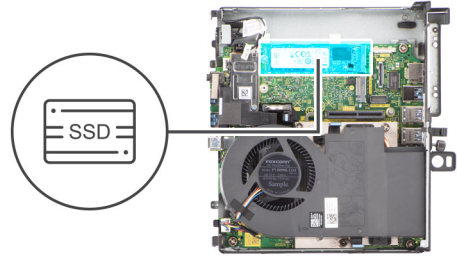

Figure 23. Removing the M.2 2280 PCIe solid state drive (slot-2)

#### Steps

1. Remove the screw (M2x3.5) that secures the 2280 SSD to the system board.
2. Slide and lift the 2280 SSD from the M.2 card slot on the system board.

## Installing the M.2 2280 PCIe SSD (slot-1)

#### Prerequisites

If you are replacing a component, remove the existing component before performing the installation procedure.

#### About this task

The following image indicates the location of the SSD and provides a visual representation of the installation procedure.

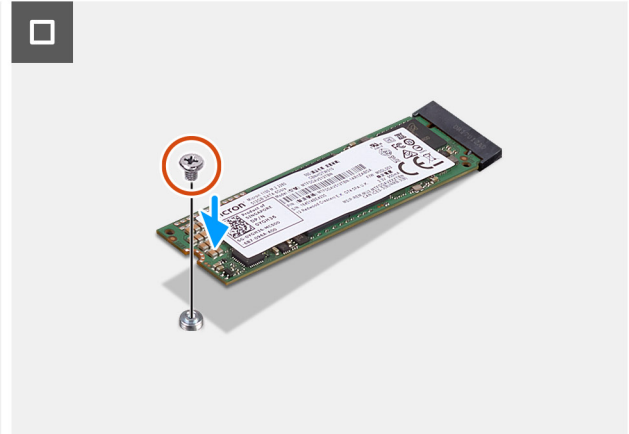
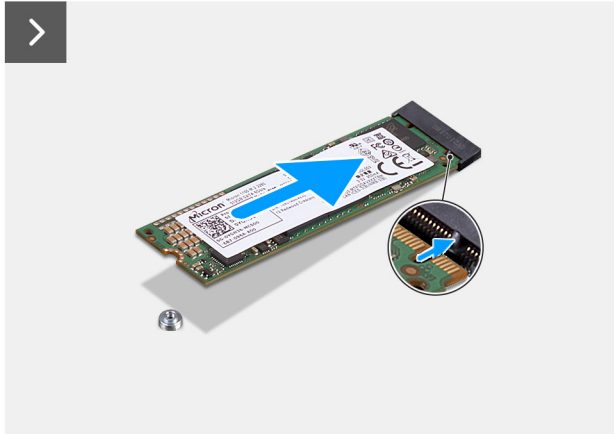
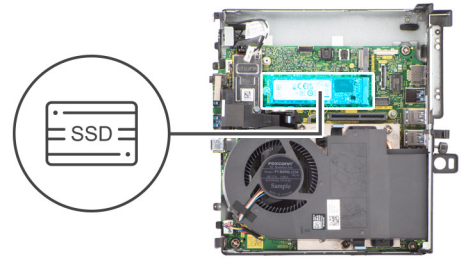

**Figure 24. Installing the M.2 2280 PCIe solid state drive (slot-1)**

**Steps**

1. Align the notch on the 2280 SSD with the tab on the M.2 card slot on the system board.
2. Slide the 2280 SSD into the M.2 card slot on the system board.
3. Replace the screw (M2x3.5) that secures the 2280 SSD to the system board.

**Next steps**

1. Install the [riser-card module](#).
2. Install the [side cover](#).
3. Follow the procedure in [after working inside your computer](#).

## Installing the M.2 2280 PCIe SSD (slot-2)

**Prerequisites**

If you are replacing a component, remove the existing component before performing the installation procedure.

**About this task**

The following image indicates the location of the SSD and provides a visual representation of the installation procedure.



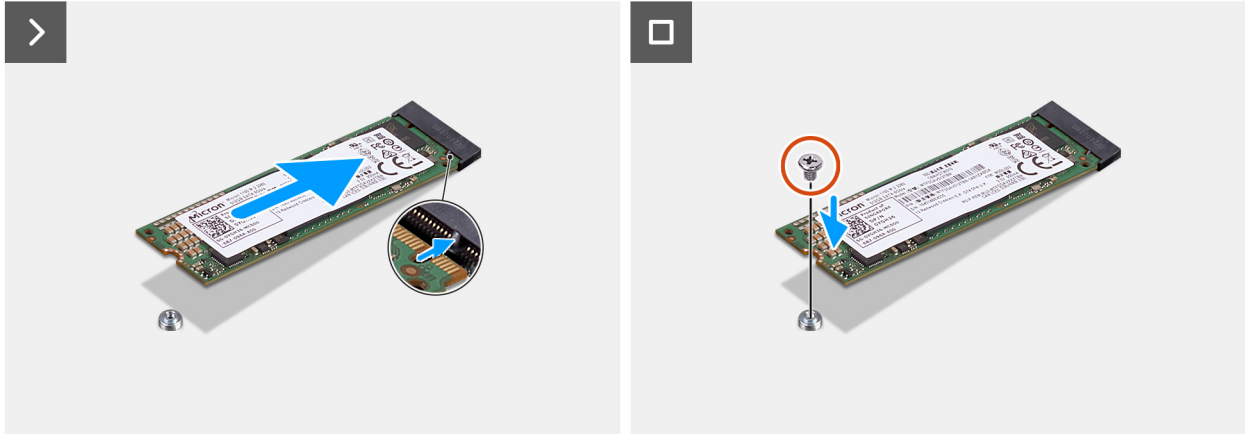
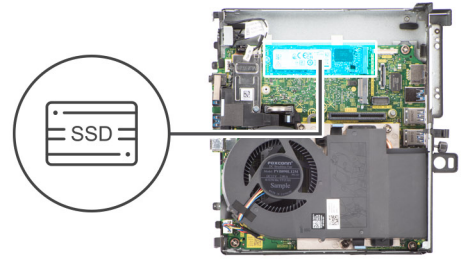

Figure 25. Installing the M.2 2280 PCIe solid state drive (slot-2)

#### Steps

1. Align the notch on the 2280 SSD with the tab on the M.2 card slot on the system board.
2. Slide the 2280 SSD into the M.2 card slot on the system board.
3. Replace the screw (M2x3.5) that secures the 2280 SSD to the system board.

#### Next steps

1. Install the [riser-card module](#).
2. Install the [side cover](#).
3. Follow the procedure in [after working inside your computer](#).

## Installing M.2 2230/2280 SSDs onto a 2230/2280 heat sink module

### Installing the M.2 2230 SSD onto a 2230 SSD heat sink module

#### Prerequisites

If you are replacing a component, remove the existing component before performing the installation procedure.

#### About this task

The following image provides a visual representation of the installation procedure for the M.2 2230 SSD onto a 2230 SSD heat sink module.

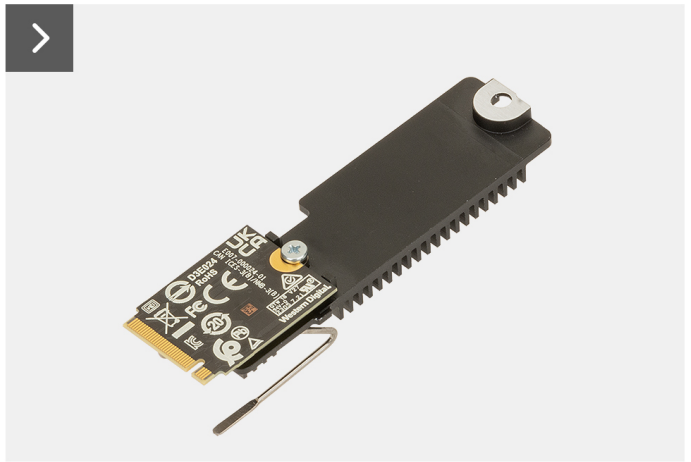
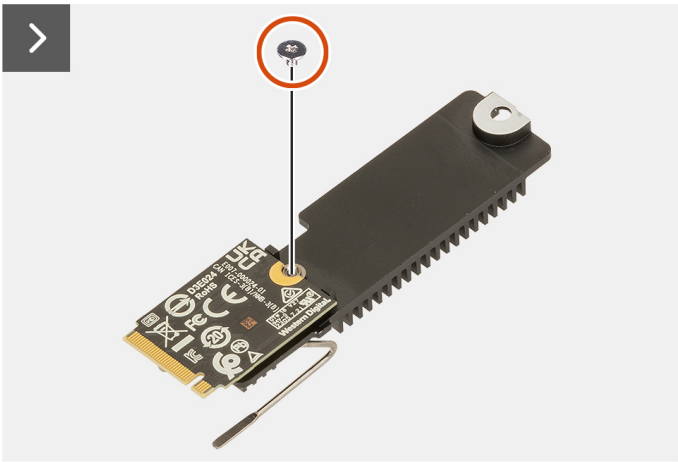
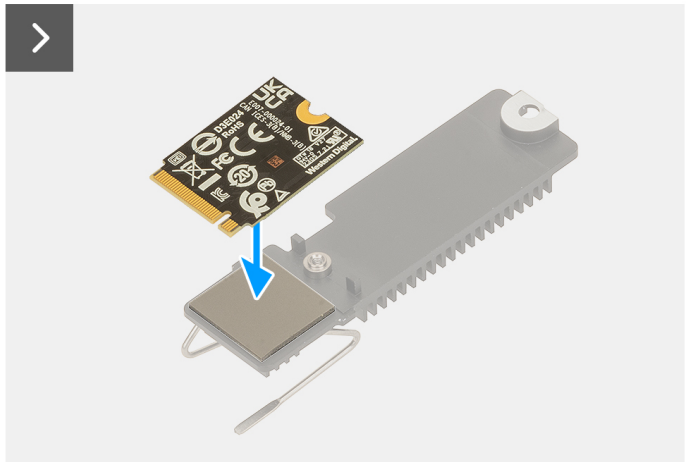
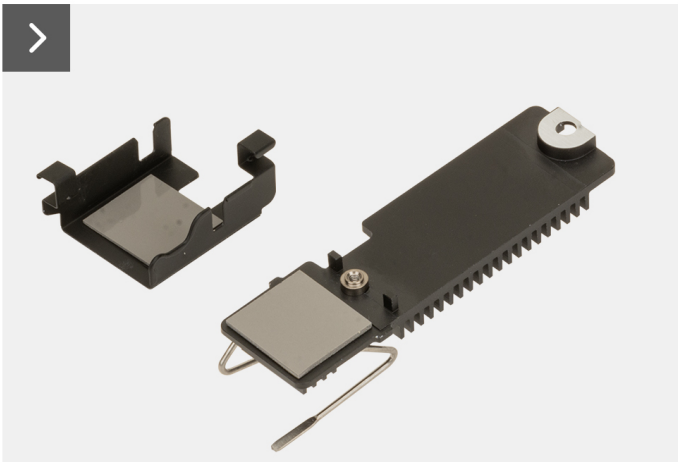
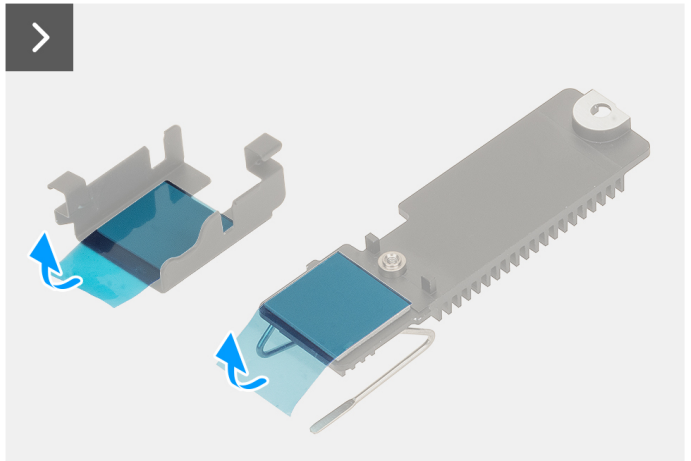
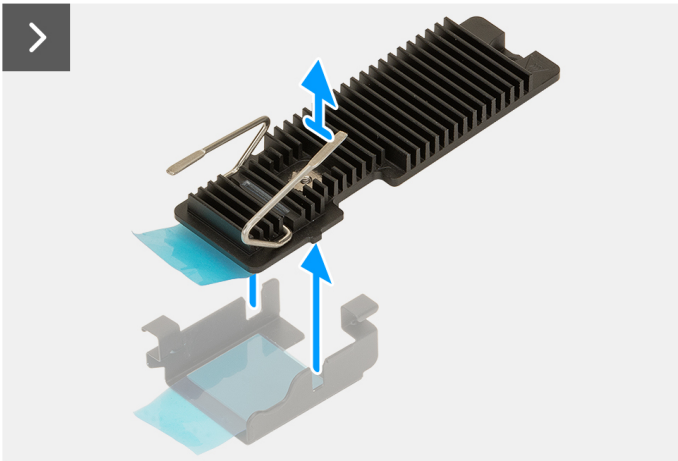
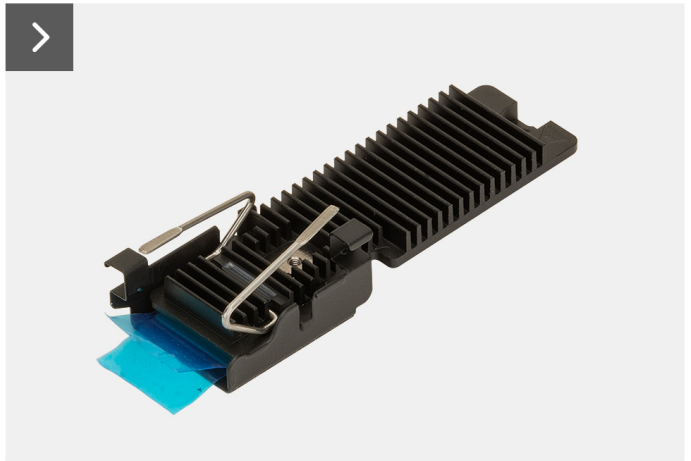
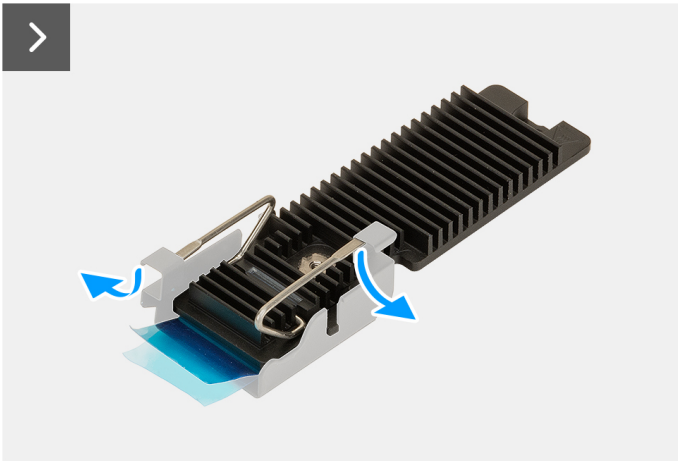



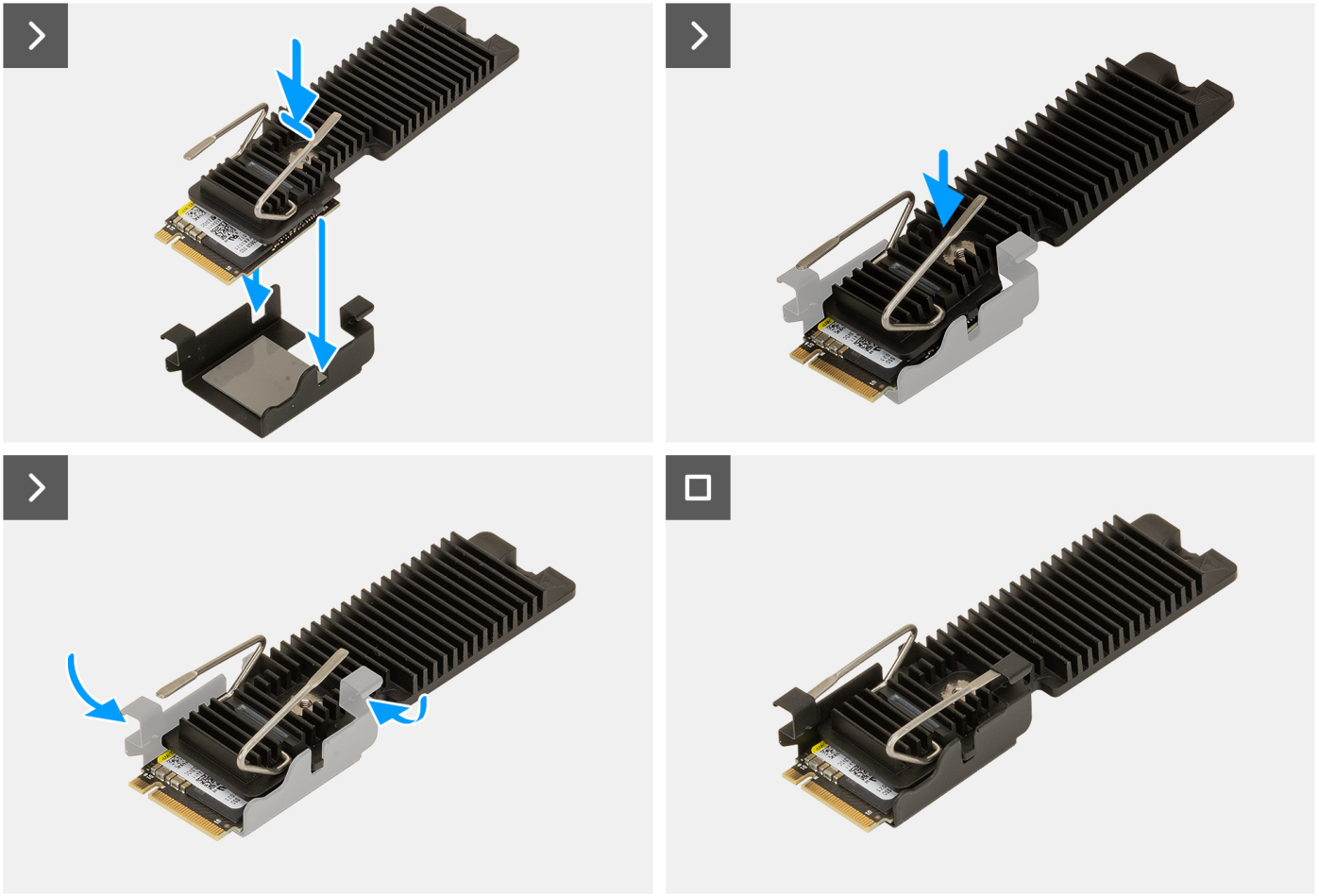

### Steps

1. Press the latch downwards and move it outwards, following the arrow in the figure.
2. Lift the top part of the 2230 heat sink module to expose the adhesive tapes on both parts. Peel off the adhesive tapes from both parts.
3. Place the 2230 SSD onto the thermal area of the heat sink module, ensuring precise alignment as shown in the figure.
4. Use the M2x3.5 screw to secure the M.2 2230 SSD onto the 2230 SSD heat sink module.
5. Place the entire assembly of the 2230 SSD along with the top part onto the other part of the heat sink module. Align it with the grooves as indicated by the arrow marks in the figure.
6. Once properly aligned, use the latch mechanism to press it downwards and lock it securely into place as shown in the figure.

## Installing the M.2 2280 SSD onto a 2280 SSD heat sink module

### Prerequisites

If you are replacing a component, remove the existing component before performing the installation procedure.

### About this task

The following image provides a visual representation of the installation procedure for the M.2 2280 SSD onto a 2280 SSD heat sink module.

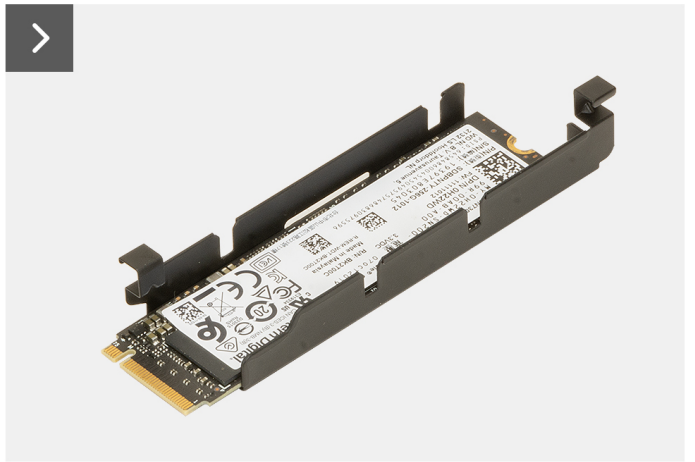
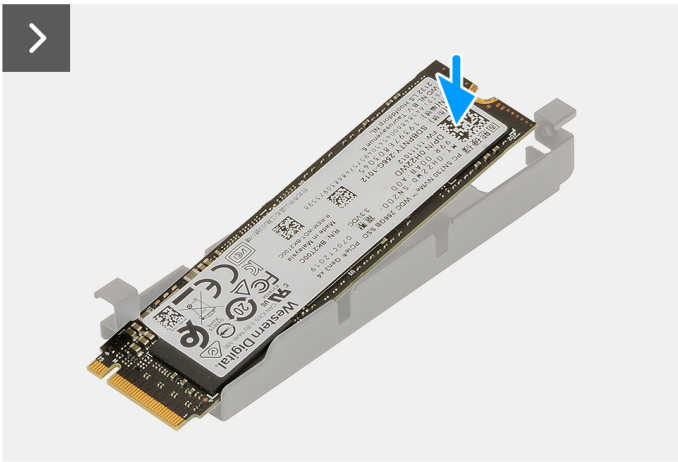
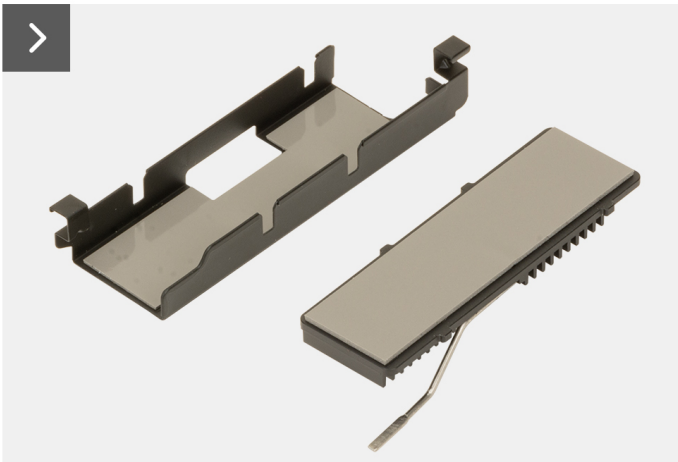
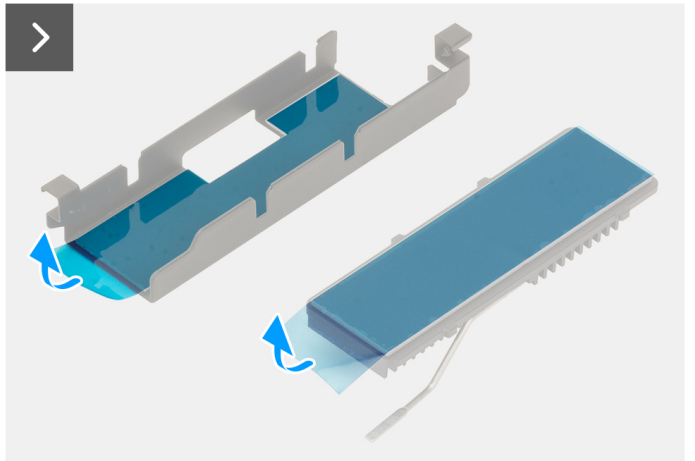
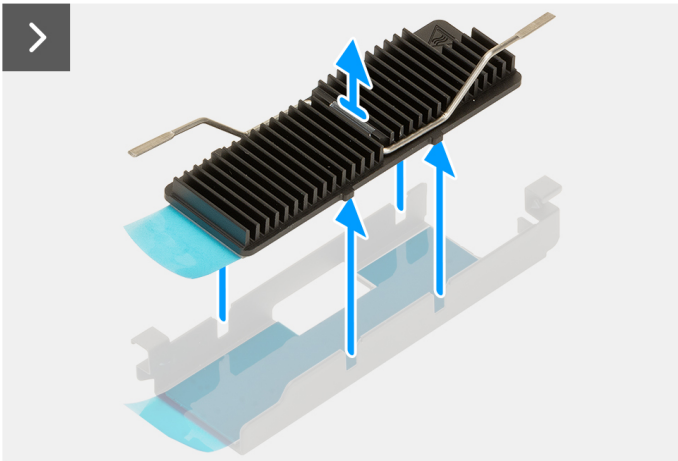
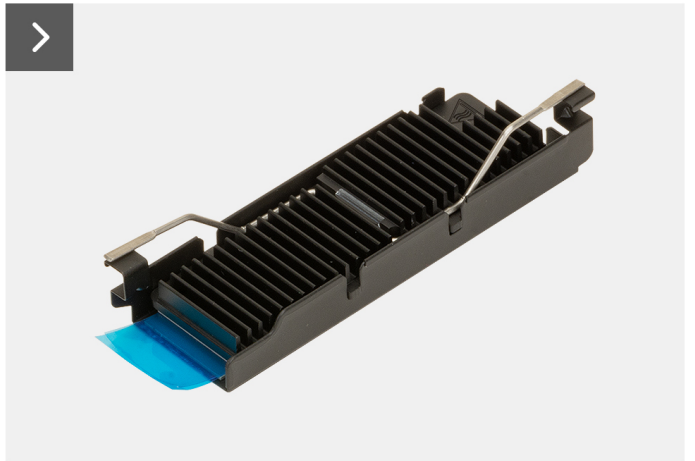
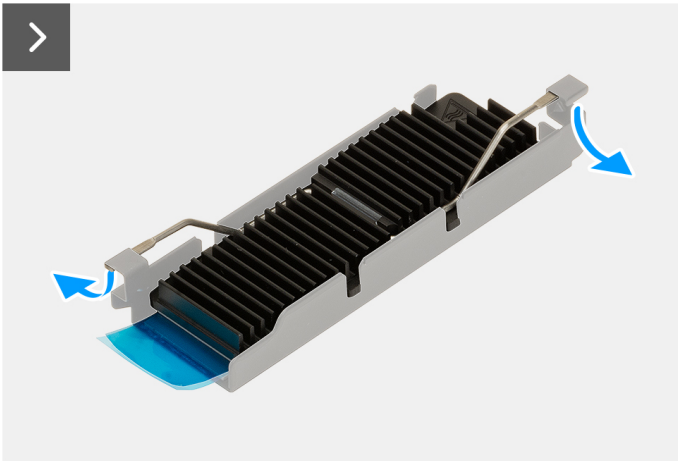

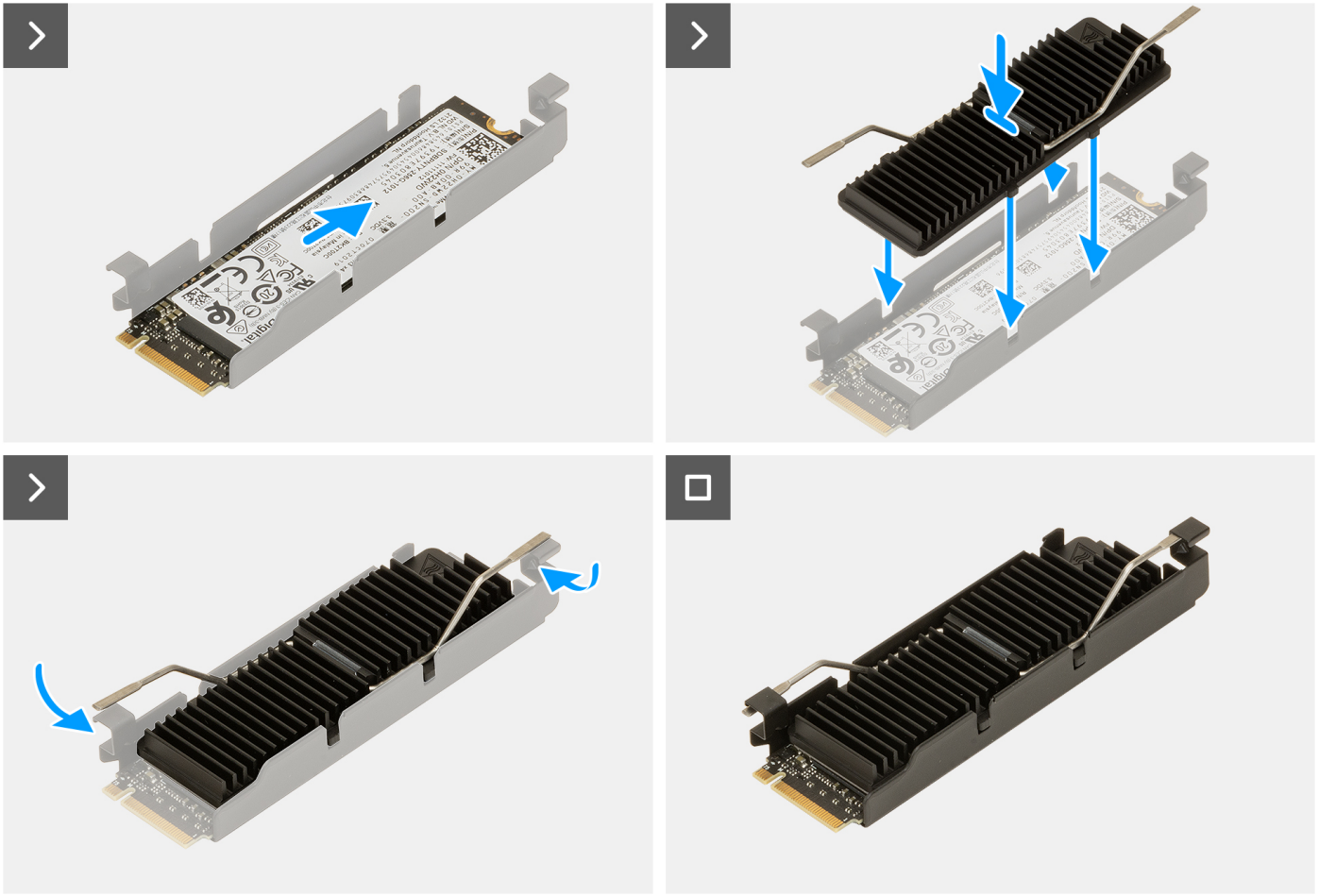

### Steps

1. Press the latch downwards and move it outwards, following the arrow in the figure.
2. Lift the top part of the 2280 heat sink module to expose the adhesive tapes on both parts. Peel off the adhesive tapes from both parts.
3. Place the 2280 SSD onto the thermal area of the bottom part of the heat sink module, ensuring precise alignment as shown in the figure.
4. Align the top part of the 2280 SSD heat sink module with the bottom part using the grooves indicated by the arrow marks in the figure.
5. Once properly aligned, use the latch mechanism to press it downwards and lock it securely into place as shown in the figure.

## Solid state drive with heat sink module

### SSD slot 1 and slot 2 cooling matrix

Precision 3280 Compact requires either a bracket or a heat sink for better thermal performance, depending on the SSD configuration. See the table below for appropriate configuration guidelines.

**Table 26. SSD cooling matrix for Precision 3280 Compact**

M.2 SSD type		Heat sink or bracket attachment	
Slot 1	Slot 2	Slot 1	Slot 2
2230		Dummy Bracket	N/A
2280		N/A	N/A

**Table 26. SSD cooling matrix for Precision 3280 Compact (continued)**

M.2 SSD type		Heat sink or bracket attachment	
2230	2230	Dummy Bracket	2230 heat sink
2230	2280	Dummy Bracket	2280 heat sink
2280	2230	N/A	2230 heat sink
2280	2280	N/A	2280 heat sink

## Removing the M.2 2230 SSD (slot-2) with heat sink module

### Prerequisites

1. Follow the procedure in [before working inside your computer](#).
2. Remove the [side cover](#).
3. Remove the [riser-card module](#).

### About this task

The following image indicates the location of the SSD with the heat sink module and provides a visual representation of the removal procedure.





1x  
M2x3.5

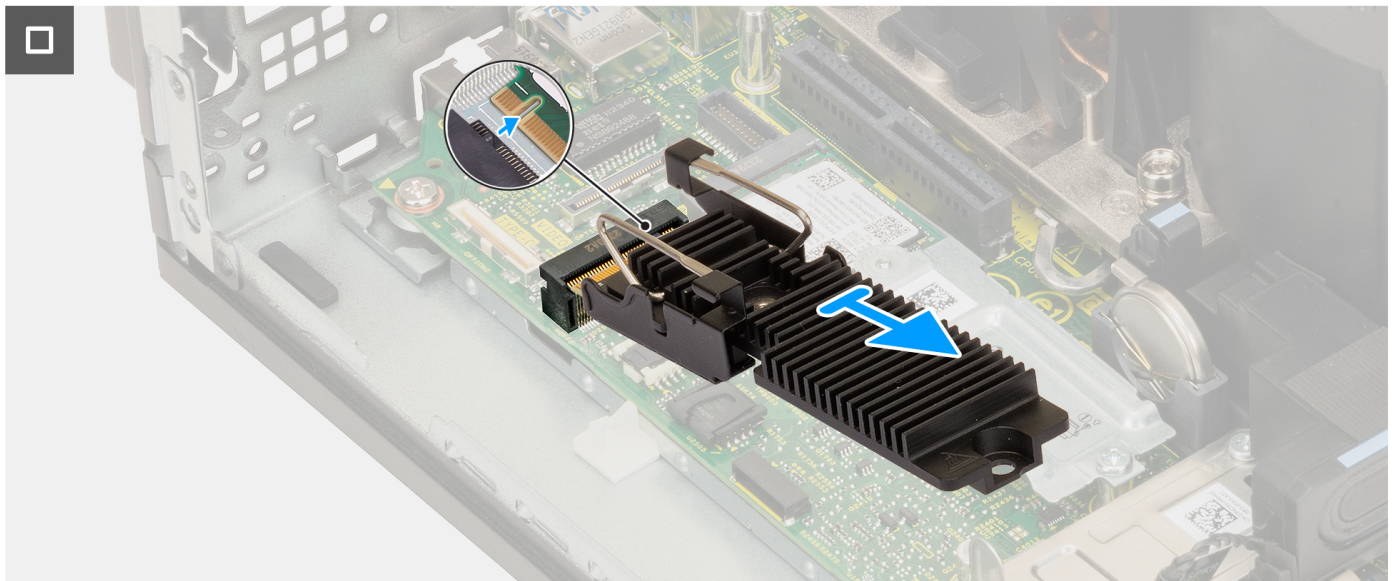
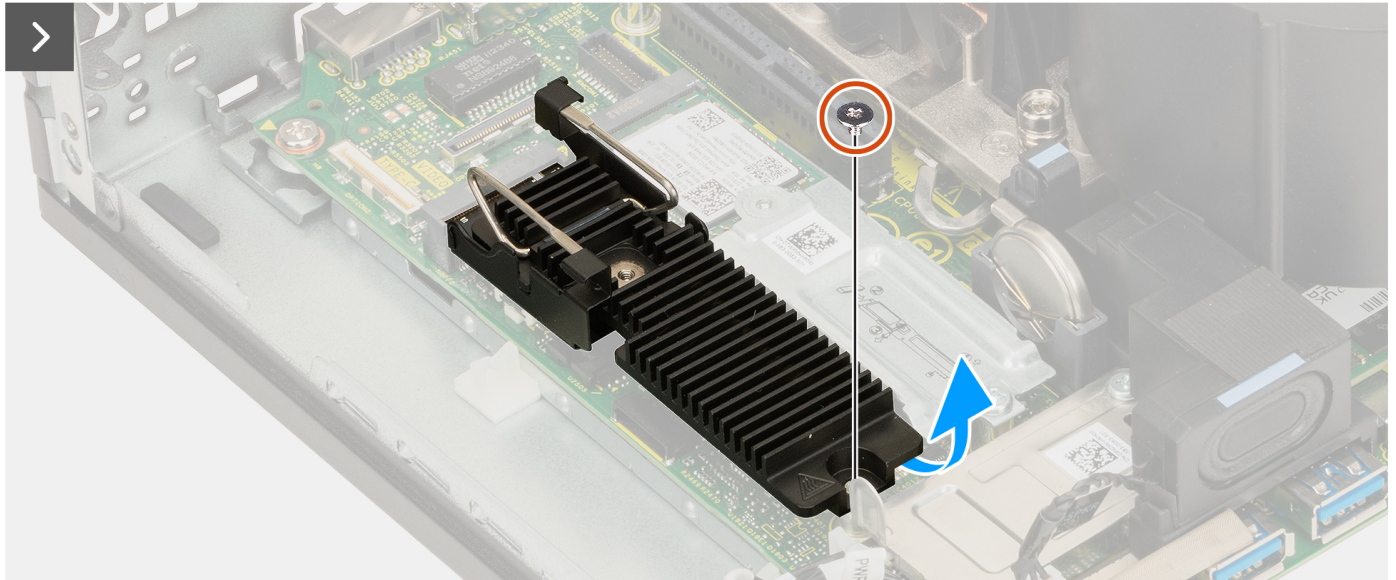
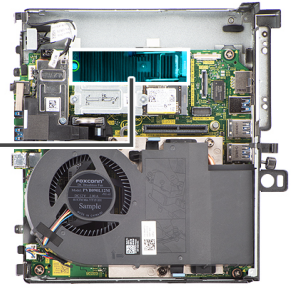

**Figure 26. Removing the M.2 2230 PCIe solid state drive (slot-2) with heat sink module**

**Steps**

1. Remove the screw (M2x3.5) that secures the 2230 SSD heat sink module to the system board.
2. Slide and lift the 2230 SSD heat sink module from M.2 card slot on the system board.



# Installing the M.2 2230 SSD (slot-2) with heat sink module

## Prerequisites

If you are replacing a component, remove the existing component before performing the installation procedure.

## About this task

The following image indicates the location of the SSD with the heat sink and provides a visual representation of the installation procedure.



1x  
M2x3.5

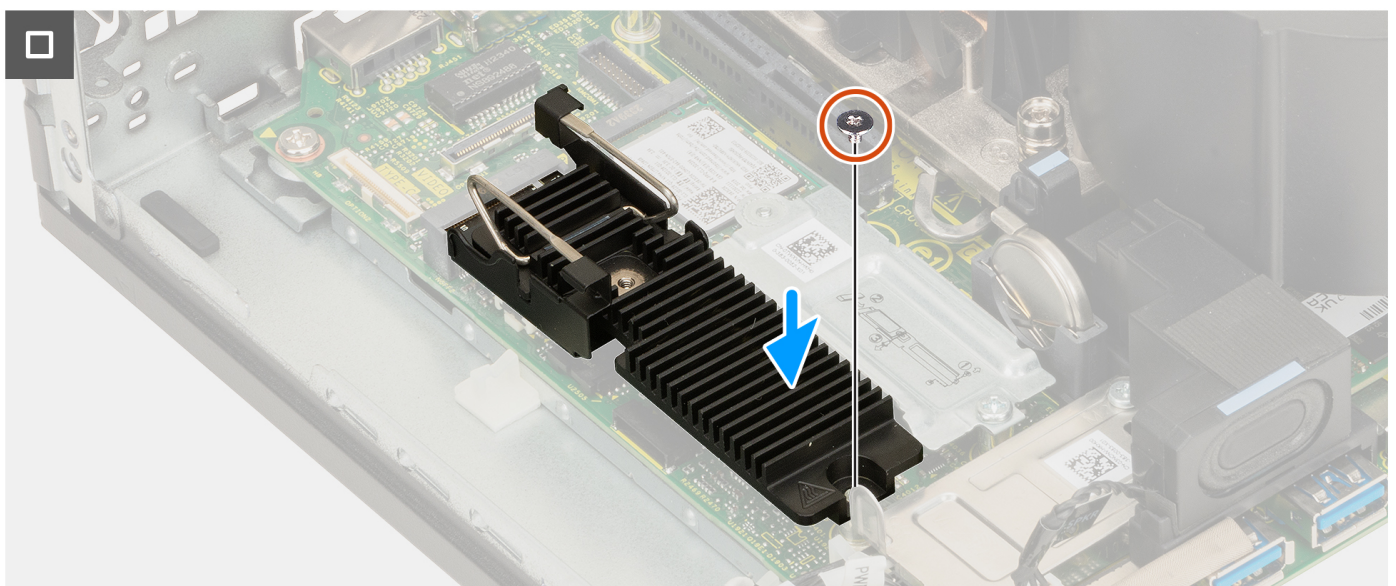
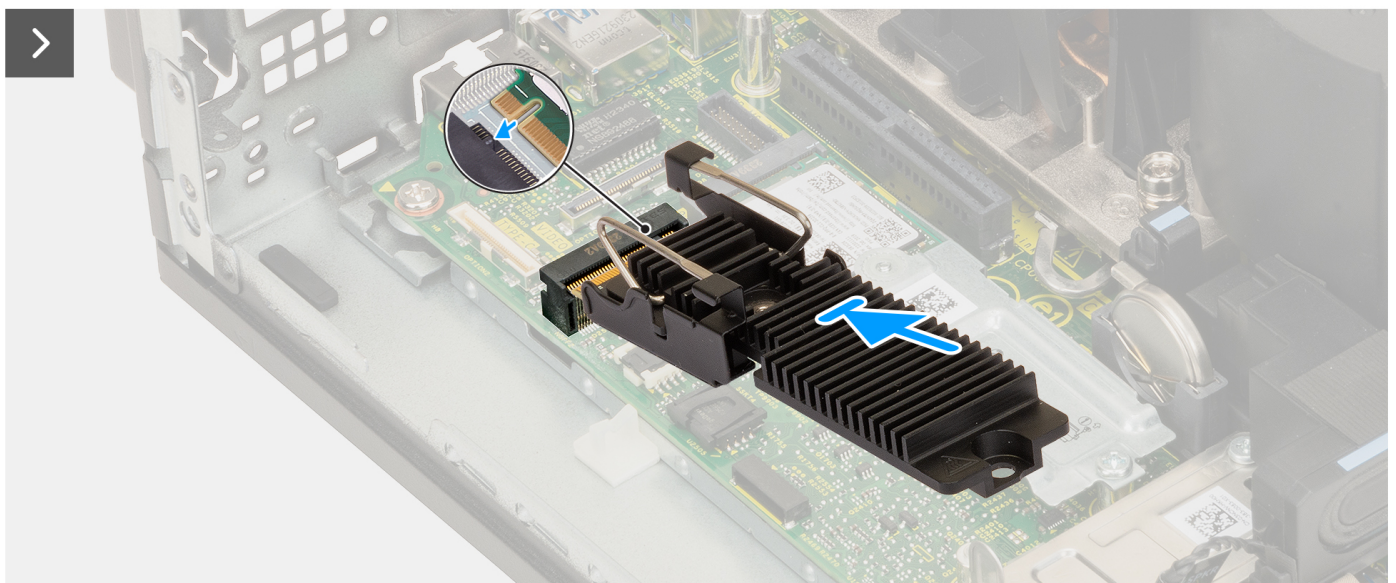
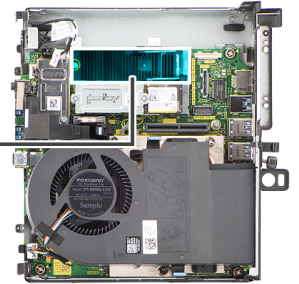

Figure 27. Installing the M.2 2230 PCIe solid state drive (slot-2) with heat sink module

### Steps

1. Align the notch on the 2230 SSD heat sink module with the tab on the M.2 card slot on the system board.
2. Slide the 2230 SSD heat sink module into the M.2 card slot on the system board.
3. Replace the screw (M2x3.5) that secures the M.2 2230 SSD heat sink module to the system board.

### Next steps

1. Install the [riser-card module](#).
2. Install the [side cover](#).
3. Follow the procedure in [after working inside your computer](#).

## Removing the M.2 2280 PCIe SSD (slot-2) with heat sink module

### Prerequisites

1. Follow the procedure in [before working inside your computer](#).
2. Remove the [side cover](#).
3. Remove the [riser-card module](#).

### About this task

The following image indicates the location of the SSD with heat sink module and provides a visual representation of the removal procedure.





1x  
M2x3.5

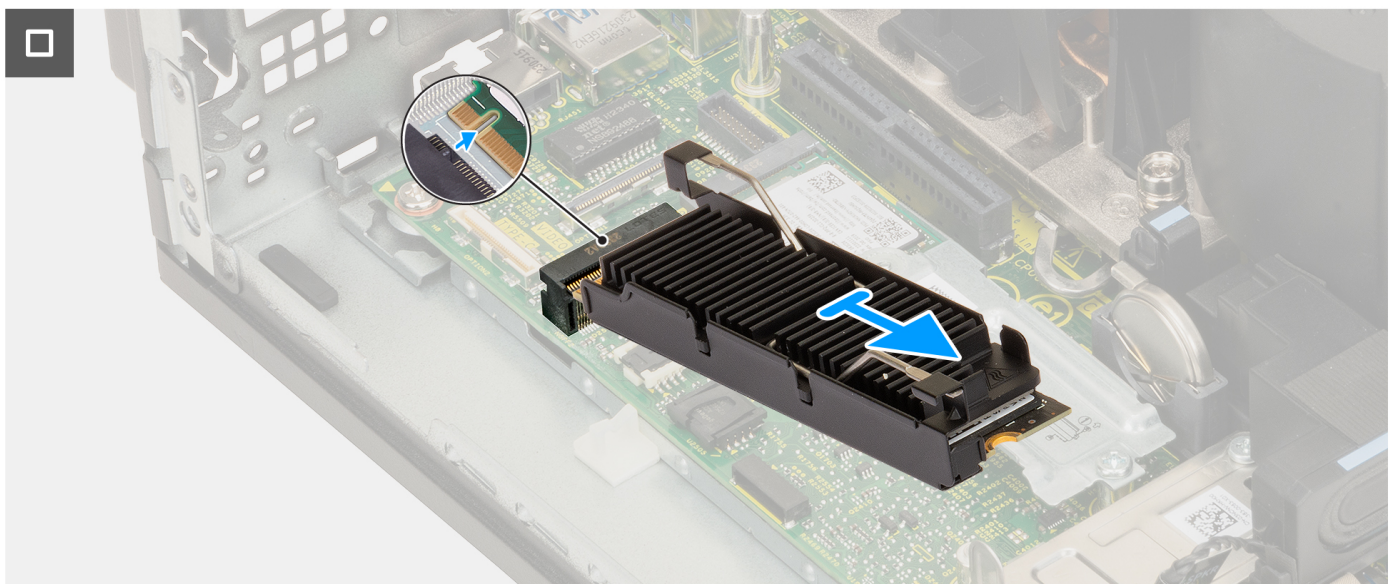
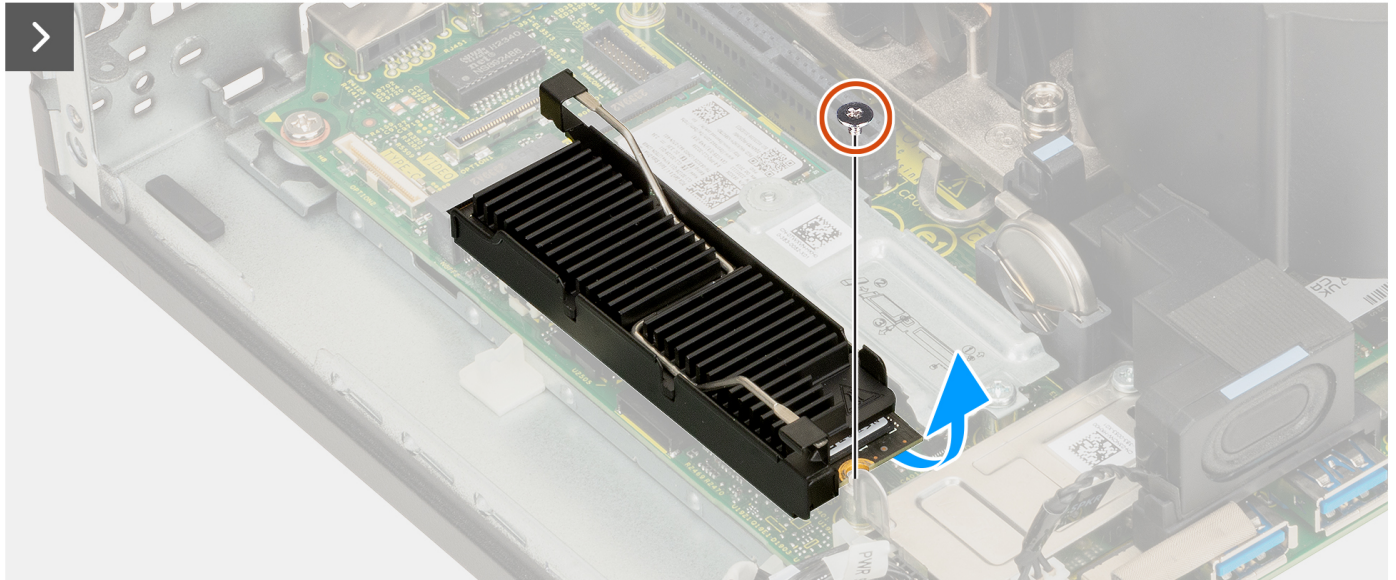
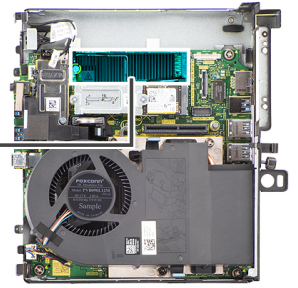

**Figure 28. Removing the M.2 2280 PCIe solid state drive (slot-2) with heat sink module**

#### Steps

1. Remove the screw (M2x3.5) that secures the 2280 SSD heat sink module to the system board.
2. Slide and lift the 2280 SSD heat sink module from the M.2 card slot on the system board.



# Installing the M.2 2280 PCIe SSD (slot-2) with heat sink module

## Prerequisites

If you are replacing a component, remove the existing component before performing the installation procedure.

## About this task

The following image indicates the location of the SSD with heat sink module and provides a visual representation of the installation procedure.

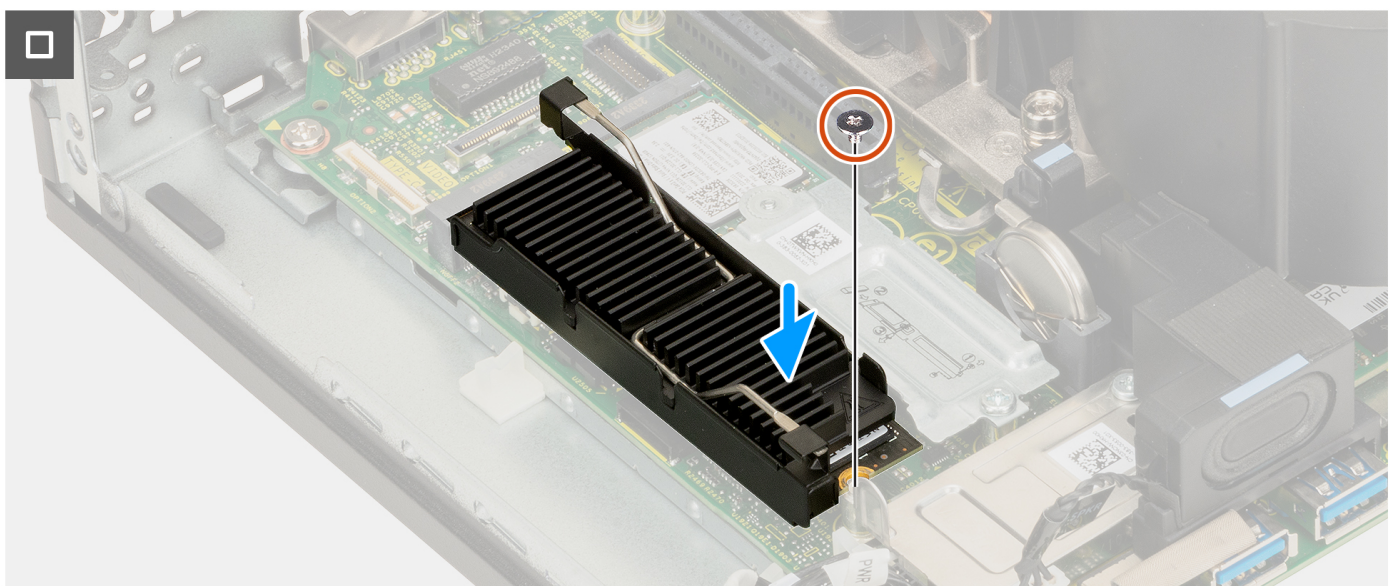
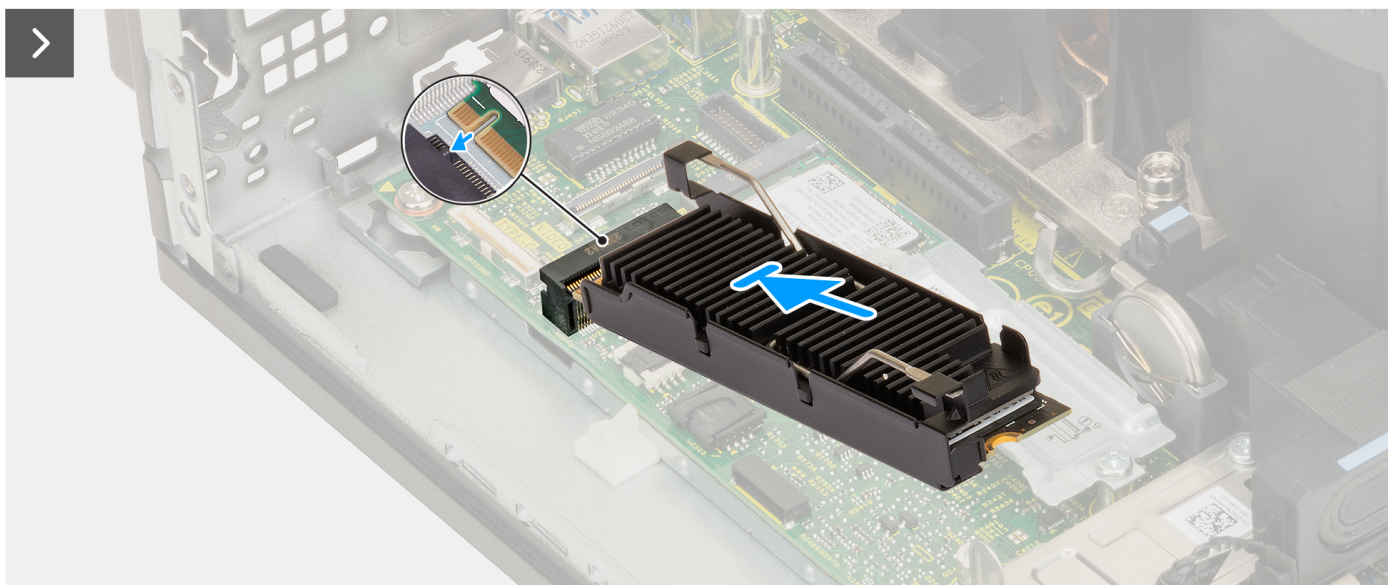
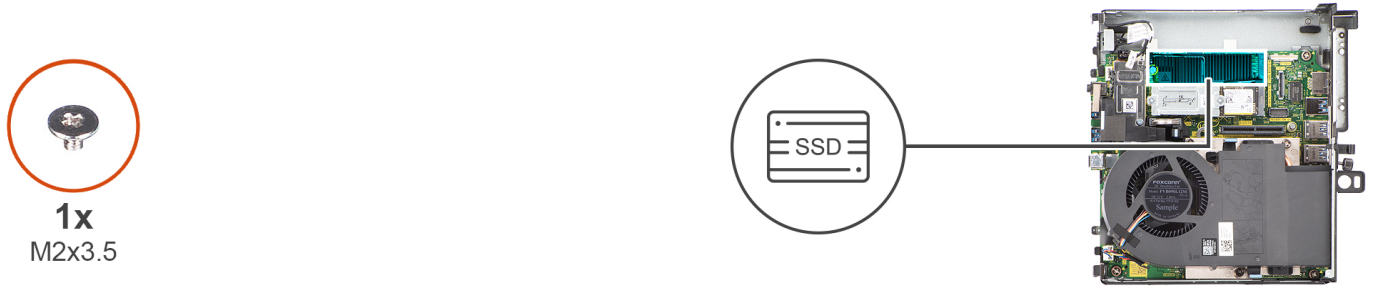

Figure 29. Installing the M.2 2280 PCIe solid state drive (slot-2) with heat sink module

### Steps

1. Align the notch on the 2280 SSD heat sink module with the tab on the M.2 card slot on the system board.
2. Slide the 2280 SSD heat sink module into the M.2 card slot on the system board.
3. Replace the screw (M2x3.5) that secures the 2280 SSD heat sink module to the system board.

### Next steps

1. Install the [riser-card module](#).
2. Install the [side cover](#).
3. Follow the procedure in [after working inside your computer](#).

## WLAN card

### Removing the wireless card

#### Prerequisites

1. Follow the procedure in [before working inside your computer](#).
2. Remove the [side cover](#).
3. Remove the [riser-card module](#).

#### About this task

The following image indicates the location of the wireless card and provides a visual representation of the removal procedure.

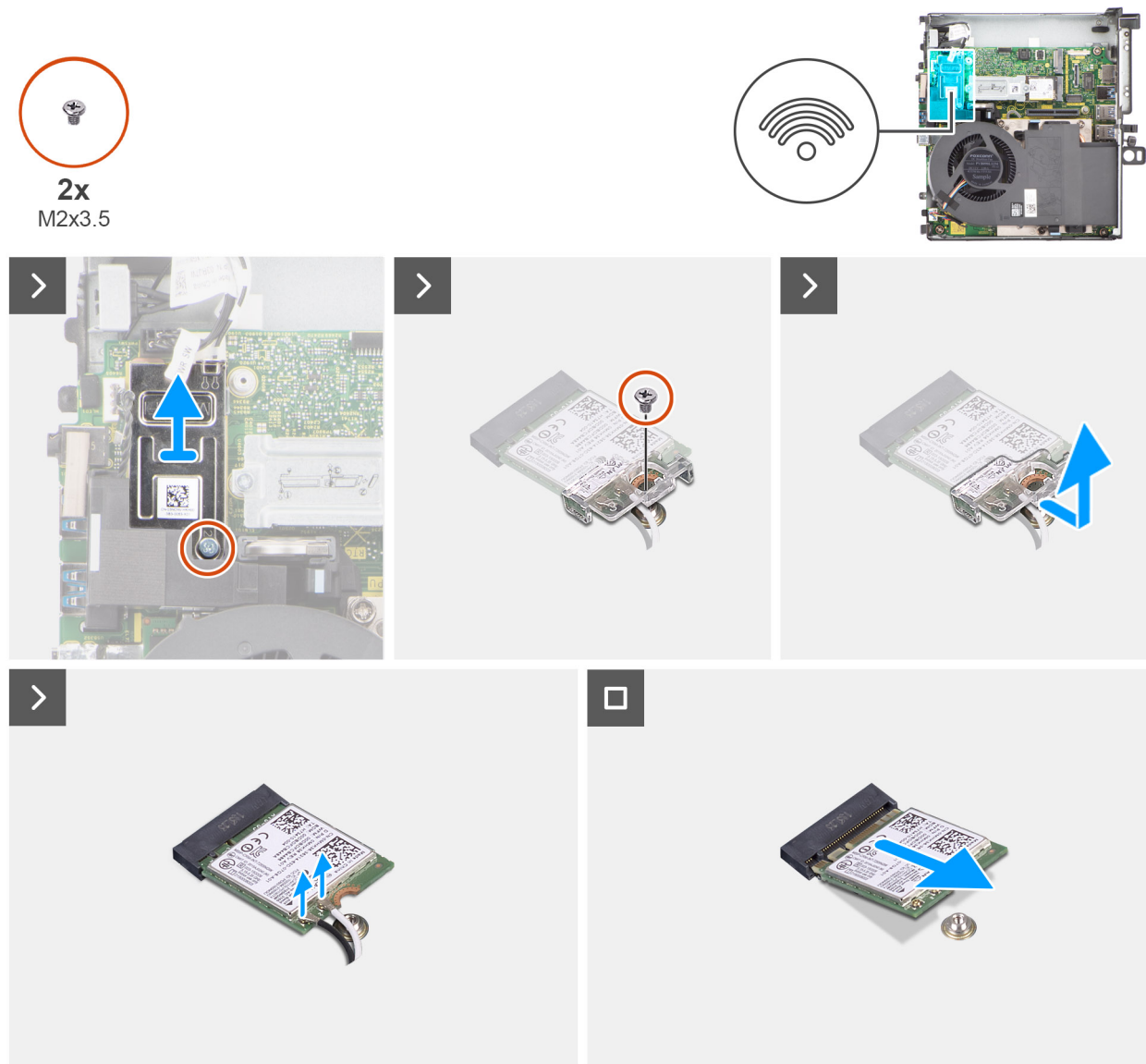

**Figure 30. Removing the wireless card**

**Steps**

1. Remove the screw (M2x3.5) that secures the wireless-card shield to the system board.
2. Lift the wireless-card shield out of the system.
3. Remove the screw (M2x3.5) that secure the wireless-card bracket to the wireless card.
4. Slide and remove the wireless-card bracket off the wireless card.
5. Disconnect the antenna cables from the wireless card.
6. Slide and remove the wireless card from the wireless-card slot.

## Installing the wireless card

**Prerequisites**

If you are replacing a component, remove the existing component before performing the installation procedure.

**About this task**

The following image indicates the location of the wireless card and provides a visual representation of the installation procedure.

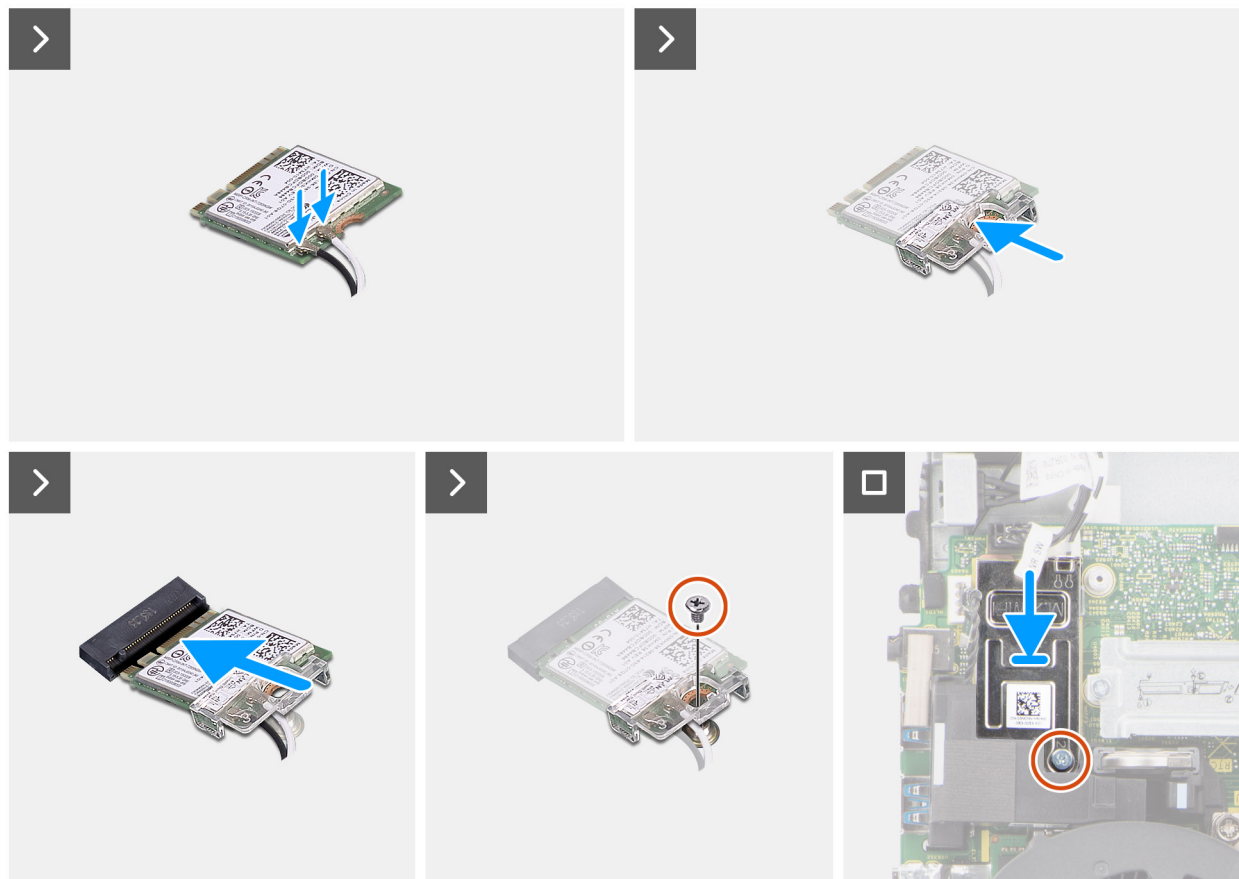
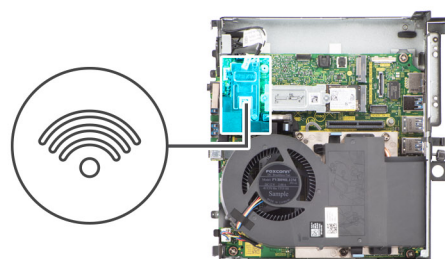

**Figure 31. Installing the wireless card**

**Steps**

1. Connect the antenna cables to the wireless card.  
The following table provides the antenna-cable color scheme for the WLAN card of your system.

**Table 27. Antenna-cable color scheme**

Connectors on the wireless card	Antenna-cable color	Silkscreen marking	
Main	White	MAIN	△ (white triangle)
Auxiliary	Black	AUX	▲ (black triangle)

2. Place the wireless-card bracket on the wireless card.
3. Align the notch on the wireless card with the tab on the wireless-card slot.
4. Slide the wireless card at an angle into the wireless-card slot.
5. Replace the screw (M2x3.5) to secure the wireless card and wireless-card bracket to the system board.
6. Align and place the wireless-card shield on the system board and wireless card.
7. Replace the screw (M2x3.5) to secure the wireless-card shield to the system board.



### Next steps

1. Install the [riser-card module](#).
2. Install the [side cover](#).
3. Follow the procedure in [after working inside your computer](#).

## Speaker

### Removing the speaker

#### Prerequisites

1. Follow the procedure in [before working inside your computer](#).
2. Remove the [side cover](#).
3. Remove the [riser-card module](#).

#### About this task

The following image indicates the location of the speaker and provides a visual representation of the removal procedure.

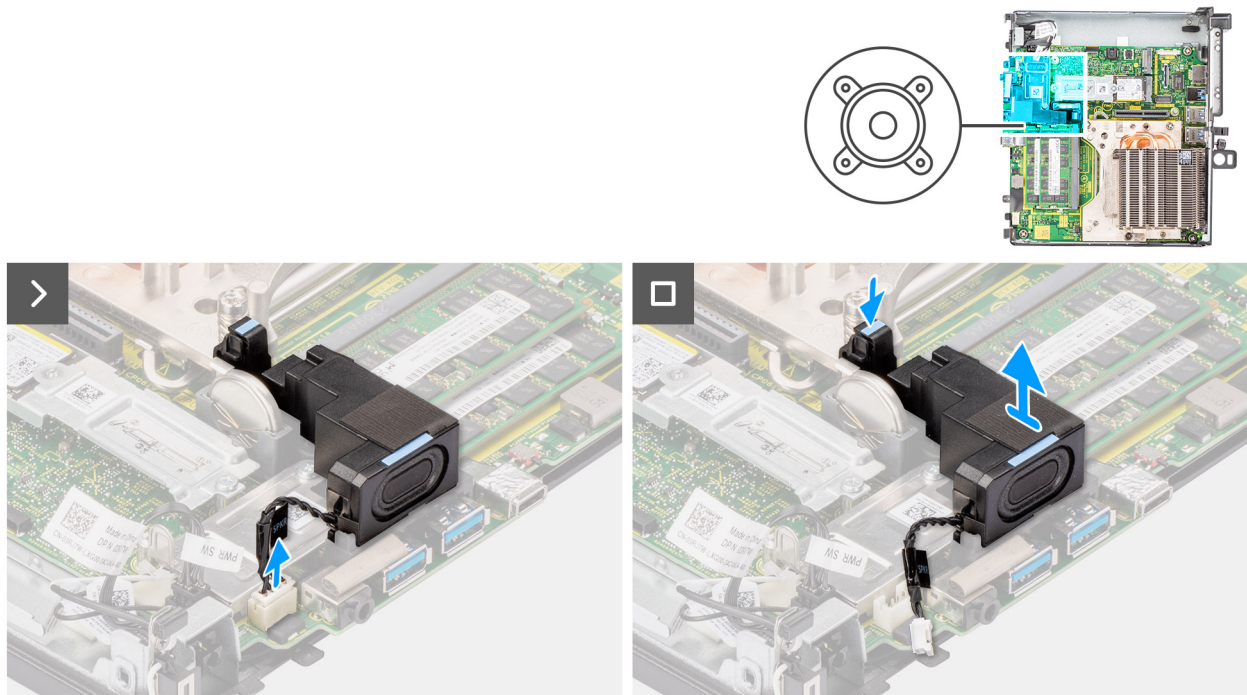

Figure 32. Removing the speaker

#### Steps

1. Disconnect the speaker cable from the connector on the system board.
2. Press the release tab and lift the speaker along with the cable from the system board.

### Installing the speaker

#### Prerequisites

If you are replacing a component, remove the existing component before performing the installation procedure.

### About this task

The following image indicates the location of the speaker and provides a visual representation of the installation procedure.

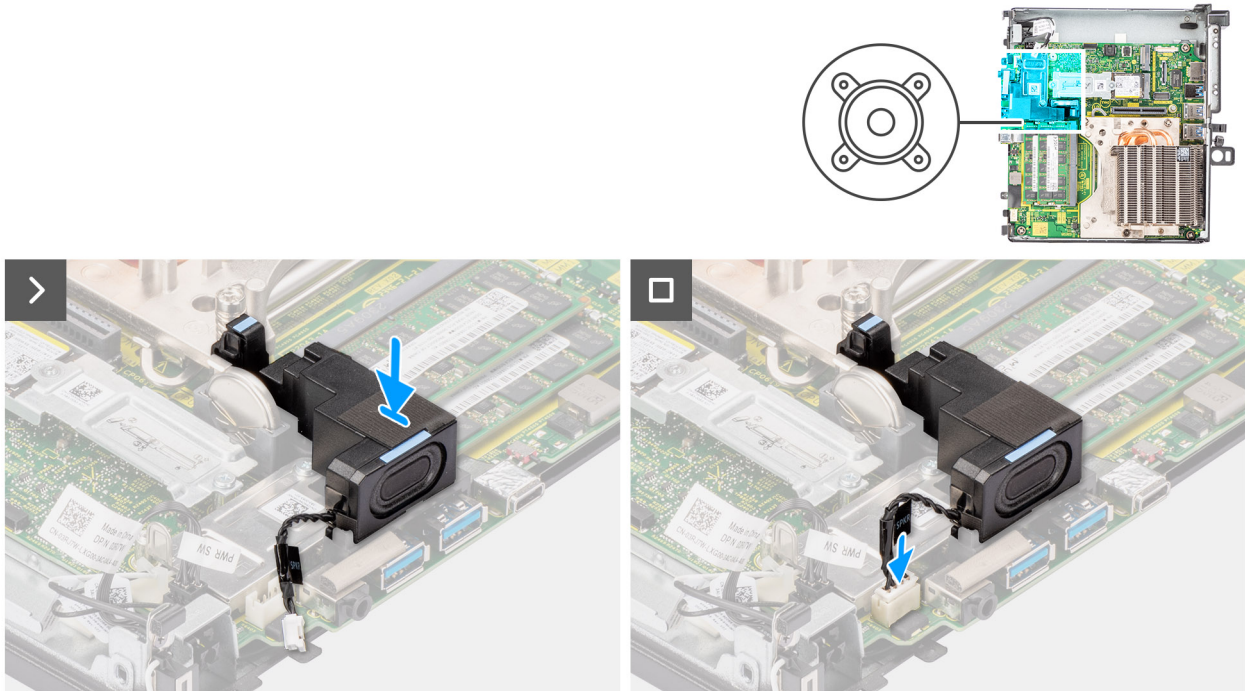

**Figure 33. Installing the speaker**

### Steps

1. Align and insert the speaker into the slot and press it until the release tab clicks.
2. Connect the speaker cable to the connector on the system board.

### Next steps

1. Install the [riser-card module](#).
2. Install the [side cover](#).
3. Follow the procedure in [after working inside your computer](#).

## Graphics card

### Removing the NVIDIA T1000 graphics card

#### Prerequisites

1. Follow the procedure in [before working inside your computer](#).
2. Remove the [side cover](#).
3. Remove the [riser-card module](#).

### About this task

The following image indicates the location of the NVIDIA T1000 graphics card and provides a visual representation of the removal procedure.



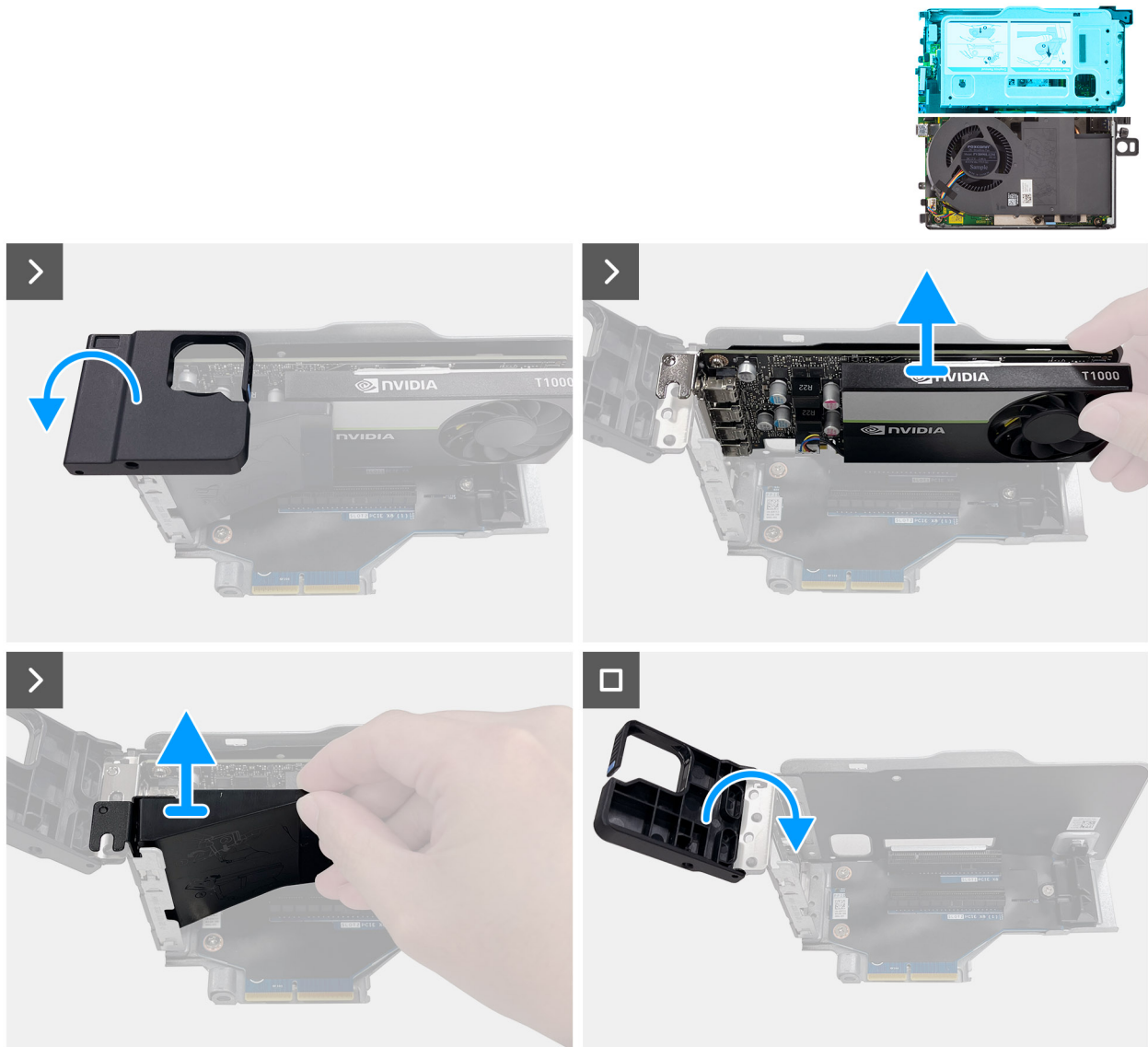

**Figure 34. Removing the NVIDIA T1000 graphics card**

**Steps**

1. Press the retainer arm to release the hook and open the retainer.
2. Slide the air duct assembly upwards along the rail of the riser-card module.
3. Slide the graphics card upwards along the edges of the riser-card module to detach it from the riser-card module.
4. Secure the retainer back into its place.

## Installing the NVIDIA T1000 graphics card

**Prerequisites**

If you are replacing a component, remove the existing component before performing the installation procedure.

**About this task**

The following image indicates the location of the Nvidia T1000 graphics card and provides a visual representation of the installation procedure.

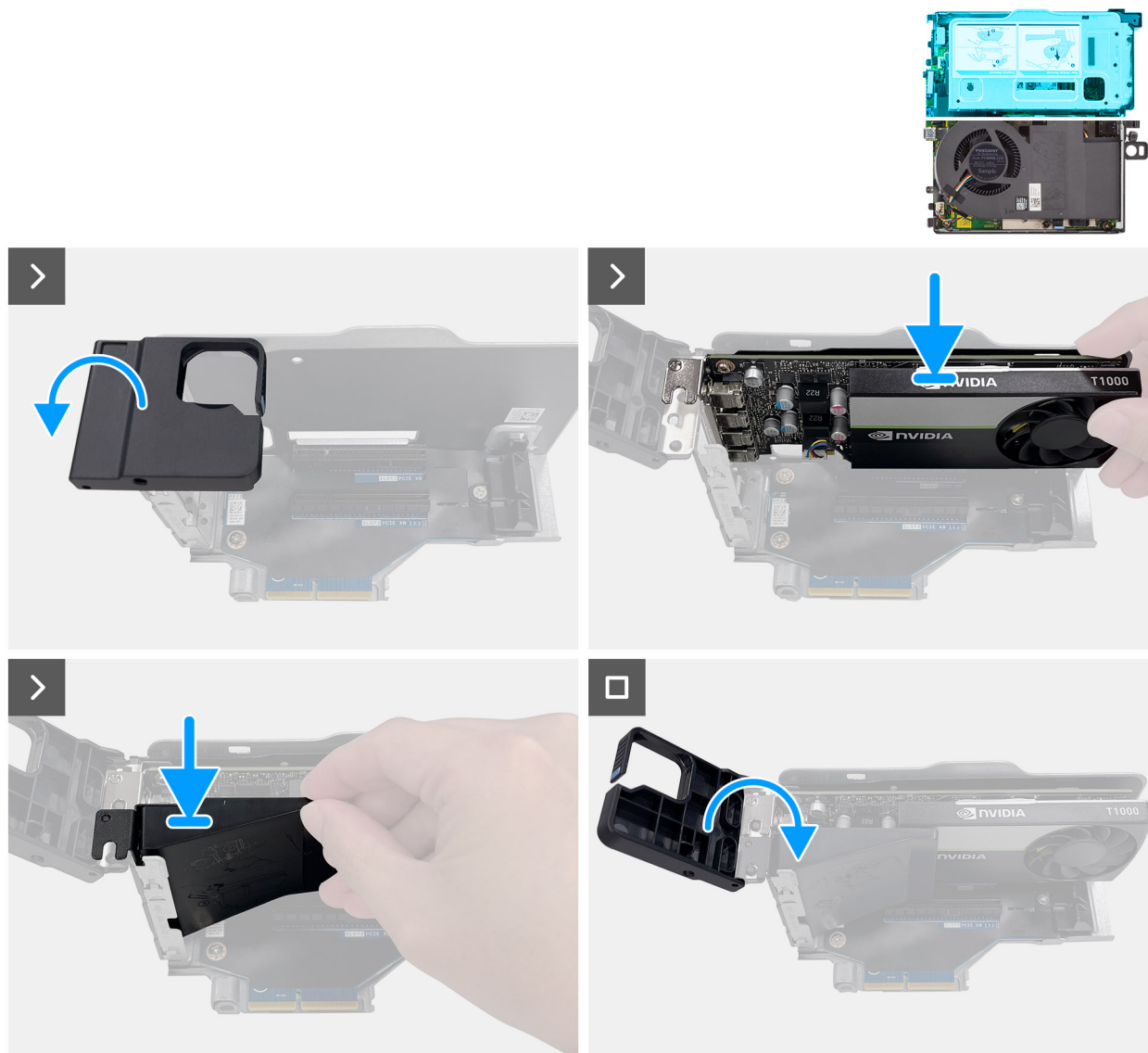

**Figure 35. Installing the NVIDIA T1000 graphics card**

### Steps

1. Press the retainer arm to release the hook and open the retainer.
2. Slide the graphics card downwards into the slot on the riser-card module until it clicks into place securely.
3. Position the air-duct assembly and then slide it into the rail on the riser-card module and push it downwards to secure it.
4. Secure the retainer back into its place.

### Next steps

1. Install the [riser-card module](#).
2. Install the [side cover](#).
3. Follow the procedure in [after working inside your computer](#).

# Removing and installing Field Replaceable Units (FRUs)

The replaceable components in this chapter are Field Replaceable Units (FRUs).

**CAUTION:** The information in this removing and installing FRU's section is intended for authorized service technicians only.

**CAUTION:** To avoid any potential damage to the component or loss of data, ensure that an authorized service technician replaces the Field Replaceable Units (FRUs).

**CAUTION:** Dell Technologies recommends that this set of repairs, if needed, to be conducted by trained technical repair specialists.

**CAUTION:** As a reminder, your warranty does not cover damages that may occur during FRU repairs that are not authorized by Dell Technologies.

**NOTE:** The images in this document may differ from your computer depending on the configuration you ordered.

## Processor fan

### Removing the processor fan

#### Prerequisites

1. Follow the procedure in [before working inside your computer](#).
2. Remove the [side cover](#).

#### About this task

The following images indicate the location of the processor fan and provide a visual representation of the removal procedure.

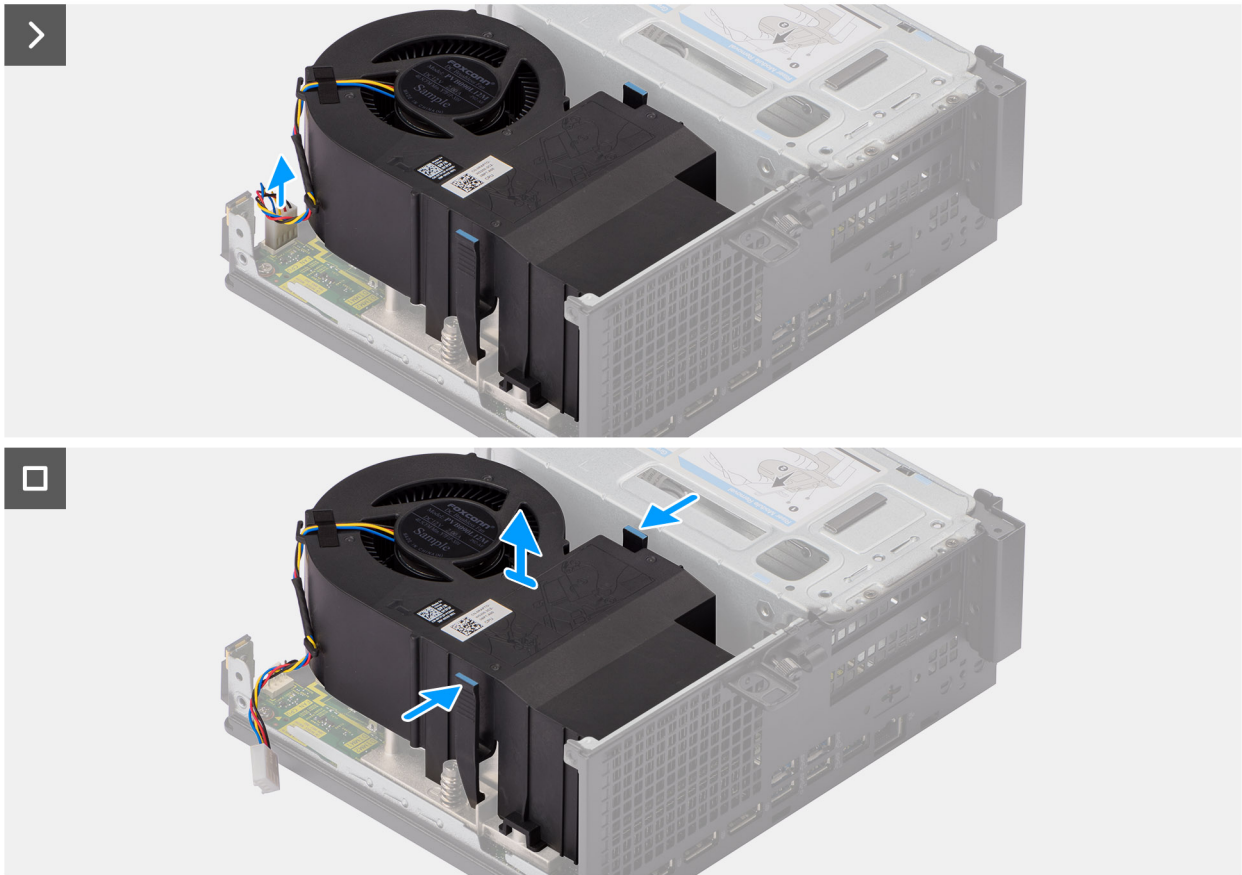
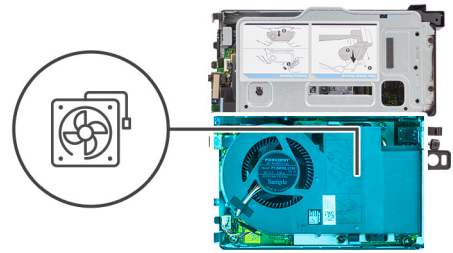

**Figure 36. Removing the processor fan**

**Steps**

1. Disconnect the fan cable from the connector on the system board.
2. Press the blue tabs on both sides of the processor fan and lift the processor fan away from the computer.

## Installing the processor fan

**Prerequisites**

If you are replacing a component, remove the existing component before performing the installation procedure.

**About this task**

The following images indicate the location of the processor fan and provide a visual representation of the installation procedure.

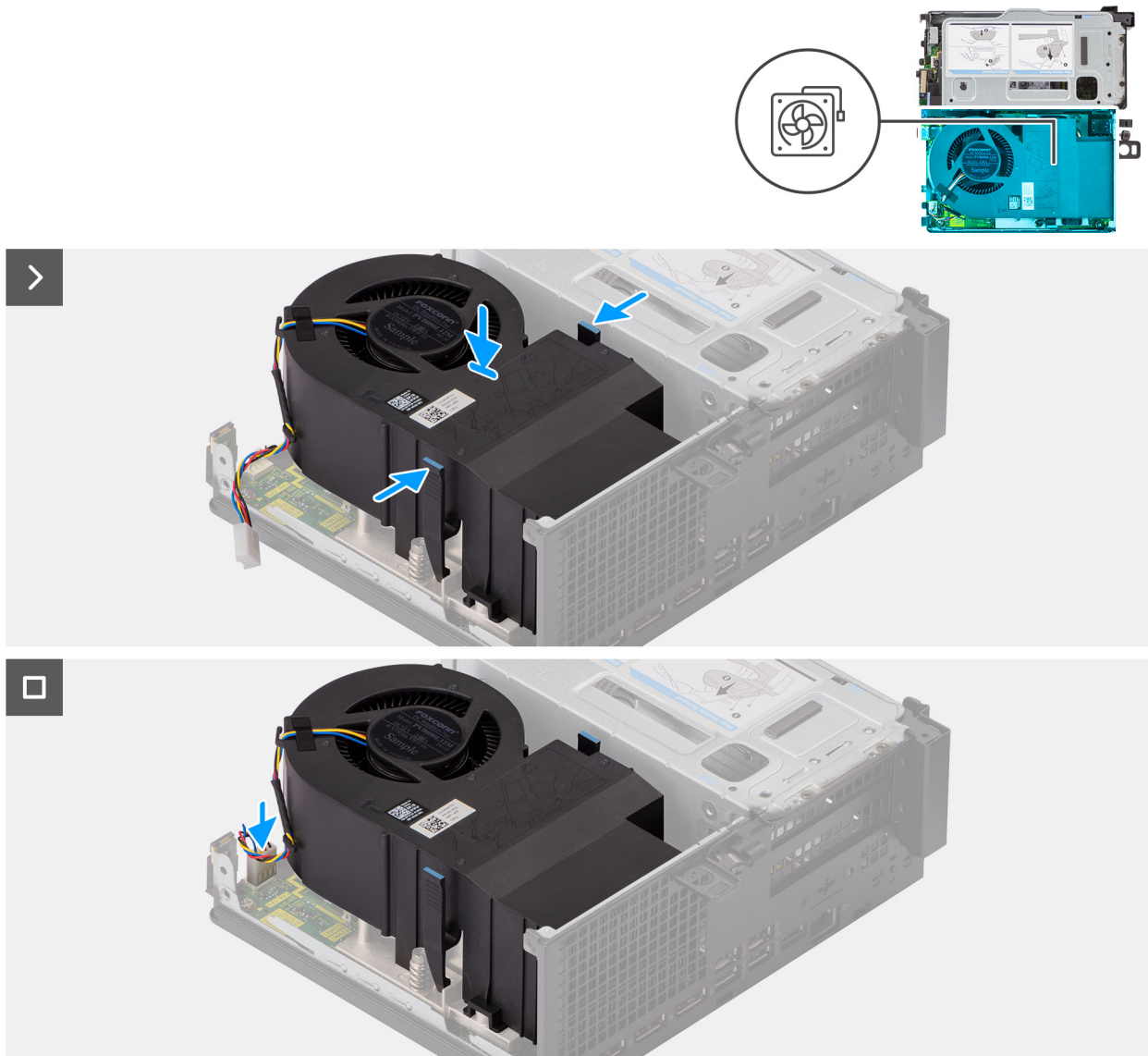

**Figure 37. Installing the processor fan**

#### **Steps**

1. Press the release tab on the processor fan and place it on the computer until it clicks into place.
2. Connect the fan cable to the connector on the system board.

#### **Next steps**

1. Install the [side cover](#).
2. Follow the procedure in [after working inside your computer](#).

## **Heat sink**

### **Removing the heat sink**

#### **Prerequisites**

1. Follow the procedure in [before working inside your computer](#).
2. Remove the [side cover](#).



3. Remove the [processor fan](#).

**About this task**

- NOTE:** The heat sink may become hot during normal operation. Allow sufficient time for the heat sink to cool before you touch it.
- NOTE:** For maximum cooling of the processor, do not touch the heat-transfer areas on the heat sink. The oils in your skin can reduce the heat-transfer capability of the thermal grease.

The following images indicate the location of the heat sink and provide a visual representation of the removal procedure.



3x

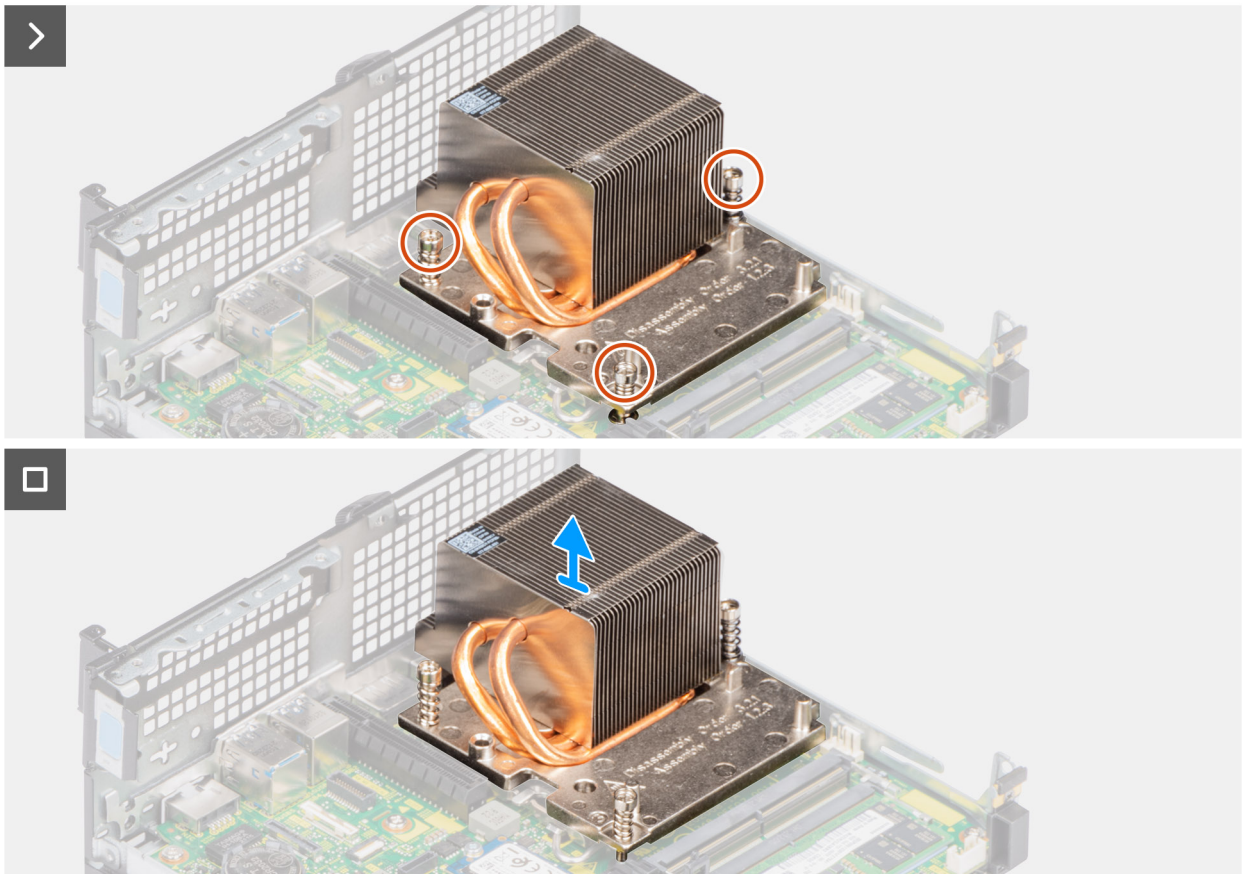
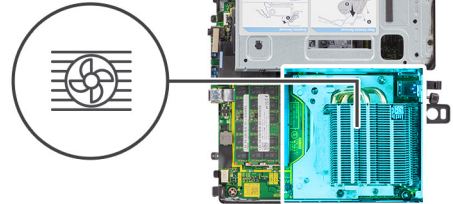

**Figure 38. Removing the heat sink**

**Steps**

1. Loosen the three captive screws in the sequential order (3->2->1) that secure the heat sink to the computer.
2. Lift the heat sink from the system board.



# Installing the heat sink

## Prerequisites

If you are replacing a component, remove the existing component before performing the installation procedure.

## About this task

**NOTE:** If either the processor or the fan and heat-sink assembly is replaced, use the thermal grease that is provided in the kit to ensure that thermal conductivity is achieved.

The following image indicates the location of the heat sink and provides a visual representation of the installation procedure.

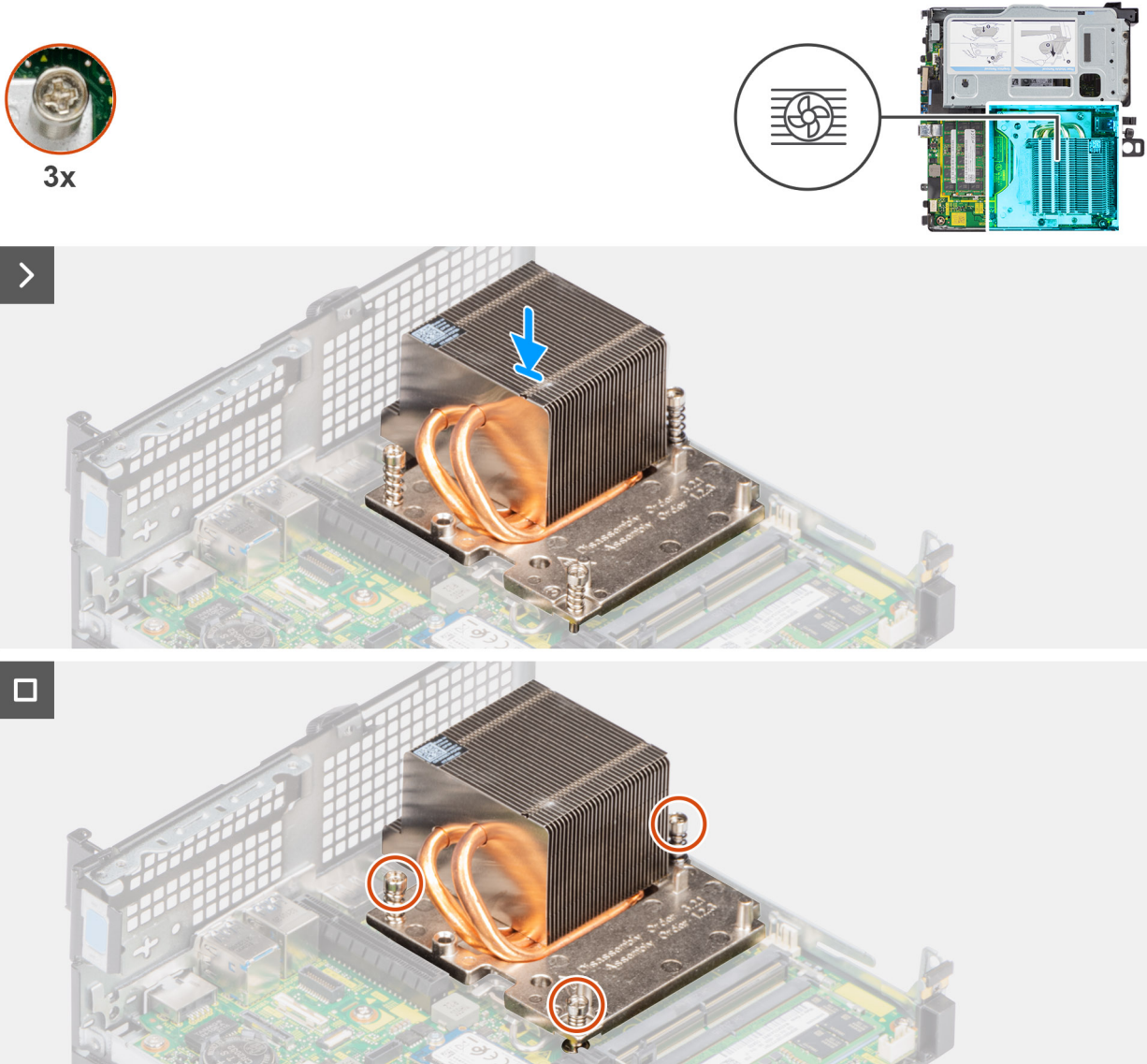

Figure 39. Installing the heat sink

## Steps

1. Align the screw holes on the heat sink with the screw holes on the system board.
2. Tighten the three captive screws in a sequential order (1->2->3) to secure the heat sink to the system board.

## Next steps

1. Install the [processor fan](#).
2. Install the [side cover](#).

3. Follow the procedure in [after working inside your computer](#).

# Processor

## Removing the processor

### Prerequisites

1. Follow the procedure in [before working inside your computer](#).
2. Remove the [side cover](#).
3. Remove the [processor fan](#).
4. Remove the [heat sink](#).

### About this task

The following images indicate the location of the processor and provide a visual representation of the removal procedure.

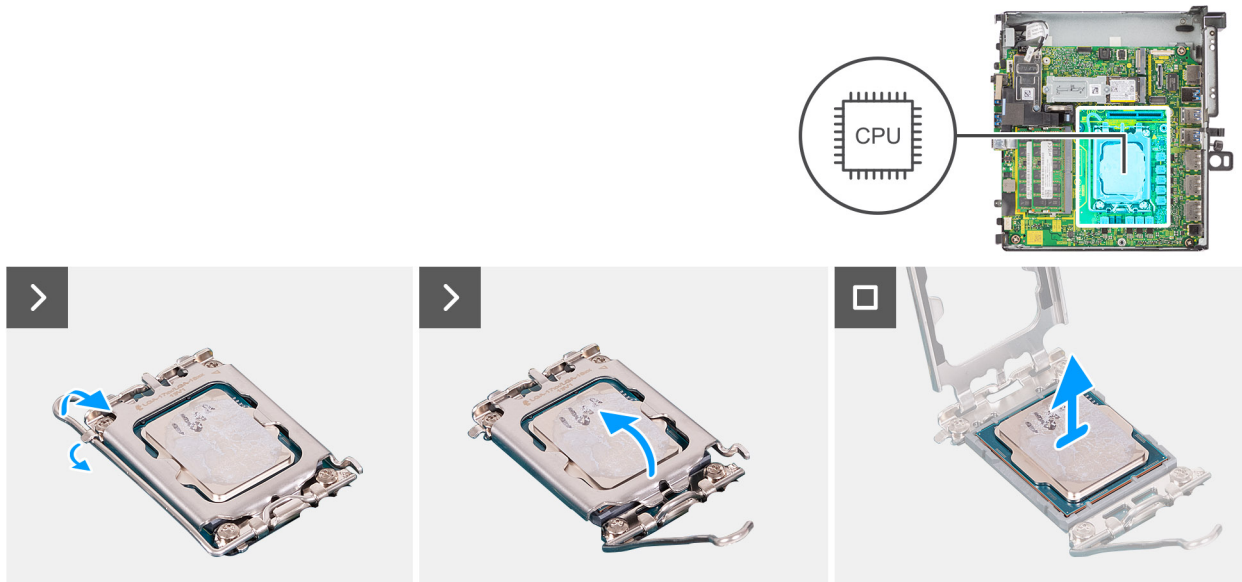

Figure 40. Removing the processor

### Steps

1. Press the release lever down and then push it away from the processor to release it from the securing tab.
2. Extend the release lever completely and open the processor cover.

**CAUTION:** When removing the processor, do not touch any of the pins inside the socket or allow any objects to fall on the pins in the socket.

3. Gently lift the processor from the processor socket.

## Installing the processor

### Prerequisites

If you are replacing a component, remove the existing component before performing the installation procedure.

### About this task

The following images indicate the location of the processor and provide a visual representation of the installation procedure.

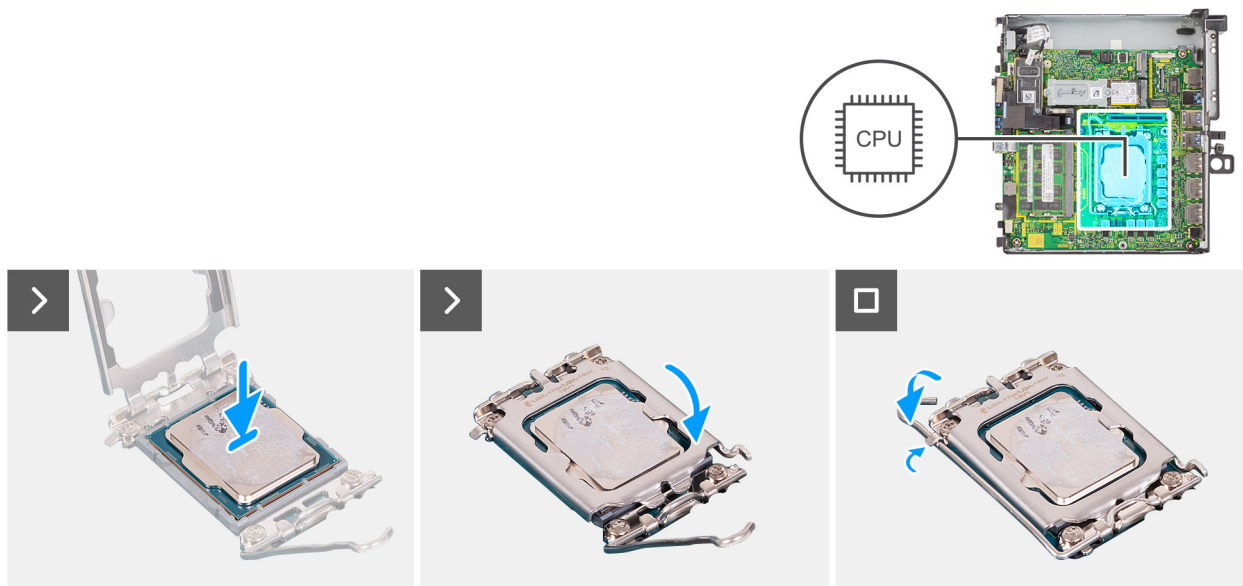

**Figure 41. Installing the processor**

### Steps

1. Ensure that the release lever on the processor socket is fully extended in the open position.
  - NOTE:** The pin-1 corner of the processor has a triangle that aligns with the triangle on the pin-1 corner on the processor socket. When the processor is properly seated, all four corners are aligned at the same height. If one or more corners of the processor are higher than the others, the processor is not seated properly.
2. Align the notches on the processor with the tabs on the processor socket and place the processor in the processor socket.
  - CAUTION:** Ensure that the processor-cover notch is positioned underneath the alignment post.
3. When the processor is fully seated in the socket, pivot the release-lever down and place it under the tab on the processor cover.

### Next steps

1. Install the [heat sink](#).
2. Install the [processor fan](#).
3. Install the [side cover](#).
4. Follow the procedure in [after working inside your computer](#).

## System board

### Removing the system board

#### Prerequisites

1. Follow the procedure in [before working inside your computer](#).
2. Remove the [side cover](#).
3. Remove the [memory modules](#).
4. Remove the [riser-card module](#).
5. Remove the [M.2 2230 SSD \(slot-1\)](#) or [M.2 2230 SSD \(slot-2\)](#).
6. Remove the [M.2 2280 SSD \(slot-1\)](#) or [M.2 2280 SSD \(slot-2\)](#).
7. Remove the [wireless card](#).
8. Remove the [coin-cell battery](#).
9. Remove the [speaker](#).



- 10. Remove the processor fan.
- 11. Remove the heat sink.
- 12. Remove the processor.

**About this task**

The following images indicate the connectors on your system board.

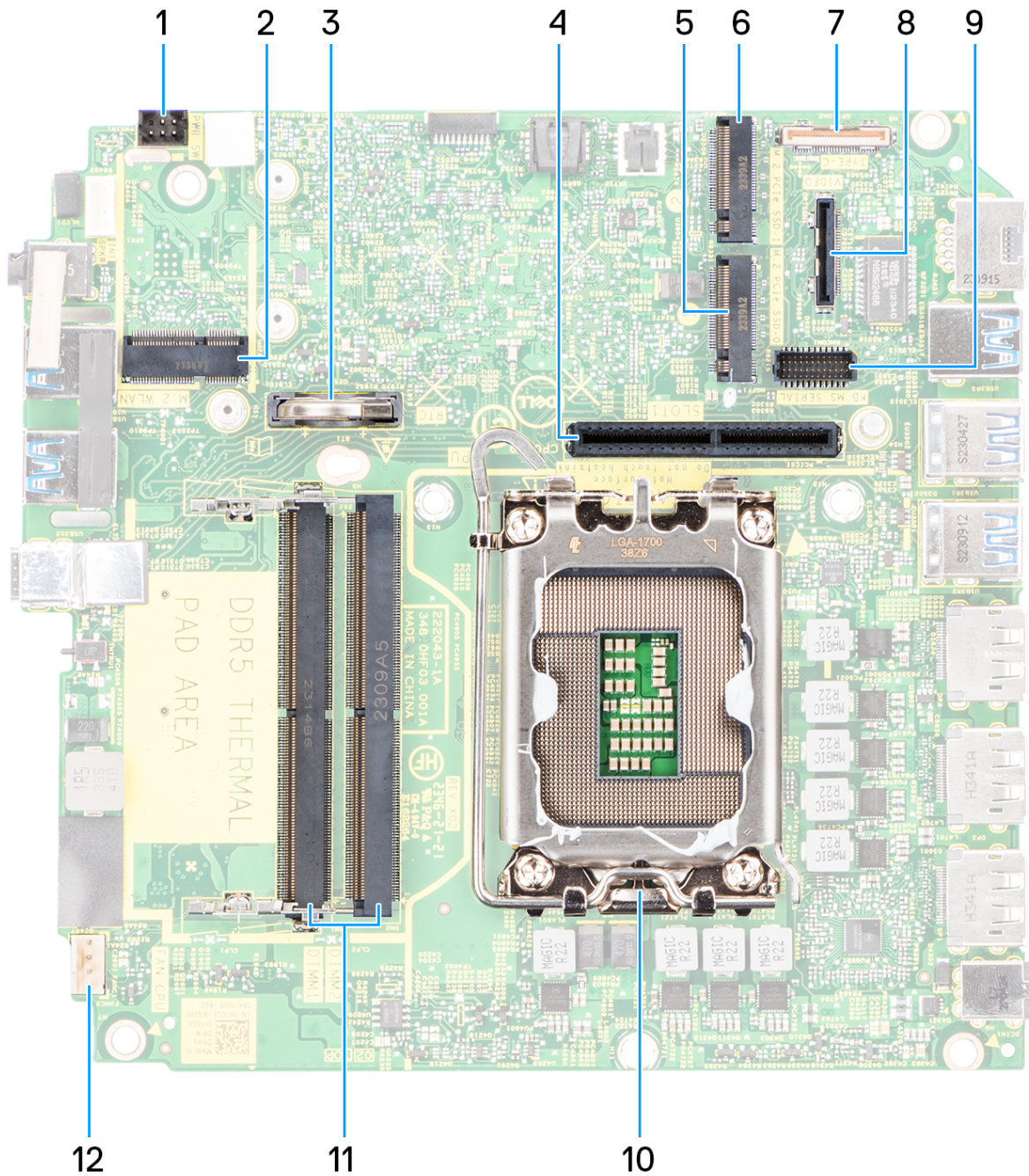

Figure 42. System board callout

Table 28. Precision 3280 CFF system board callouts

No	Connector	Description
1	PWR_SW	Power switch connector

**Table 28. Precision 3280 CFF system board callouts (continued)**

No	Connector	Description
2	M.2 WLAN	WLAN slot
3	RTC	Coin cell battery
4	PCIe riser connector	Riser support two PCIe Gen x8 open end connector(Electrically x8 for slot1, x1 for slot2)
5	M.2 PCIe SSD-0	M.2 PCIe SSD slot
6	M.2 PCIe SSD-1	M.2 PCIe SSD slot
7	TYPE-C	Type-C optional connector (USB 3.2 Gen 2 Type-C Port)
8	VIDEO	Optional video connector(VGA Port/Display Port 1.4a(HBR3)/HDMI 2.1 Port)
9	KB MS SERIAL	Optional PS/2,serial port connector
10	CPU	Processor socket
11	DIMM1 to DIMM2	Memory module connectors
12	FAN CPU	CPU fan connector

The following images indicate the location of the system board and provide a visual representation of the removal procedure.

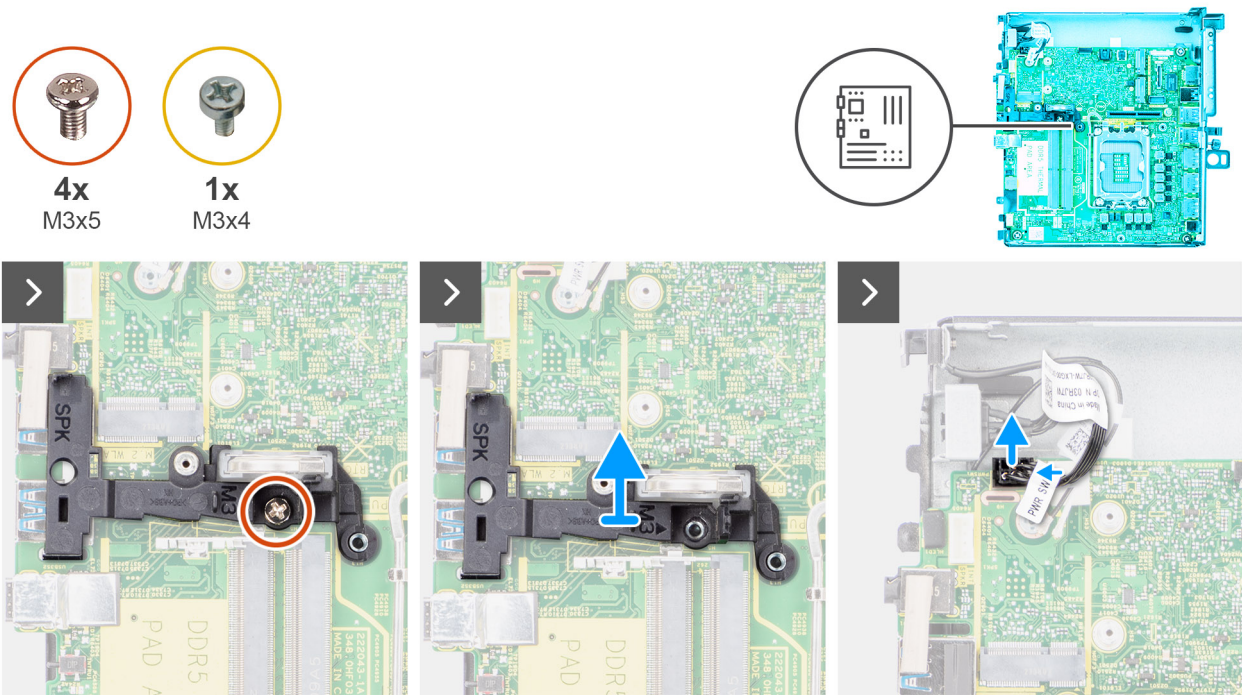

**Figure 43. Removing the system board**



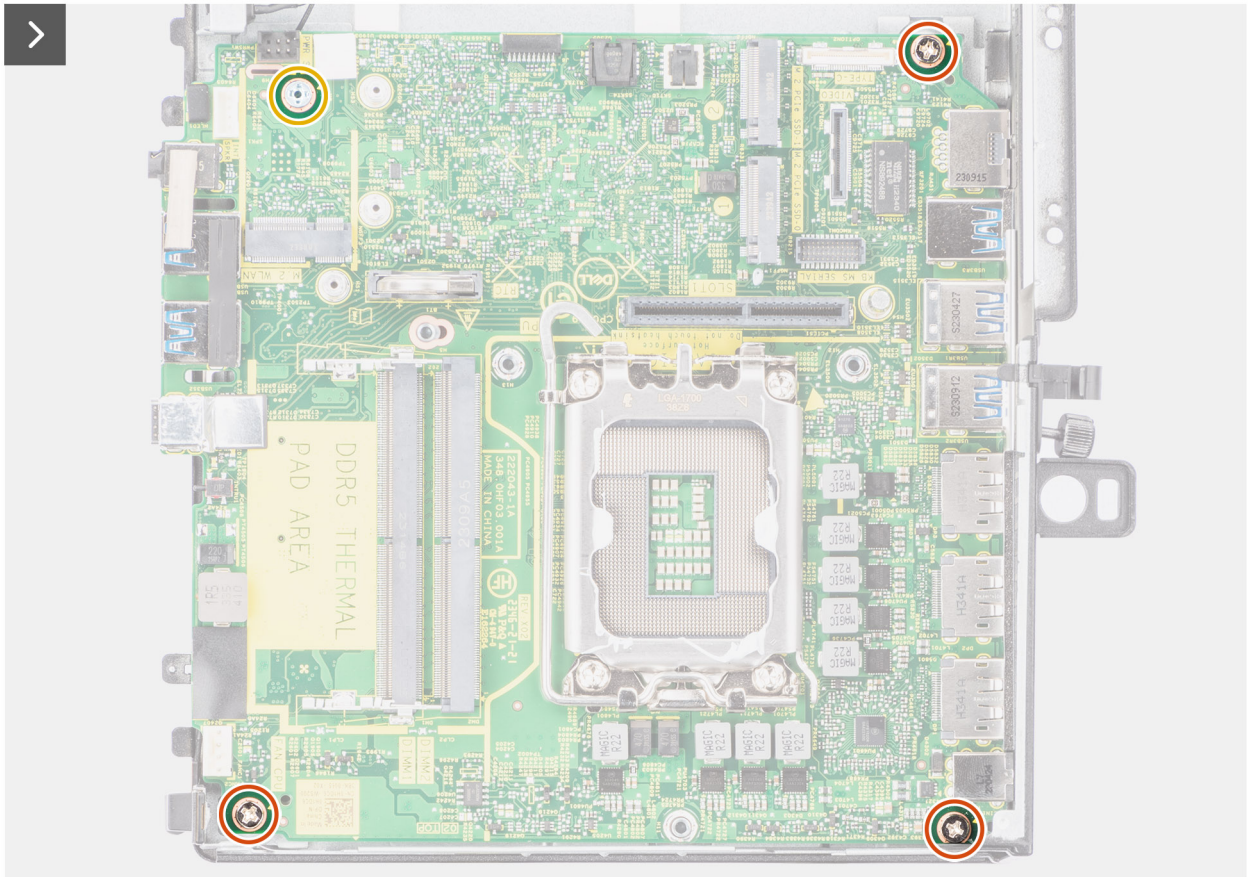
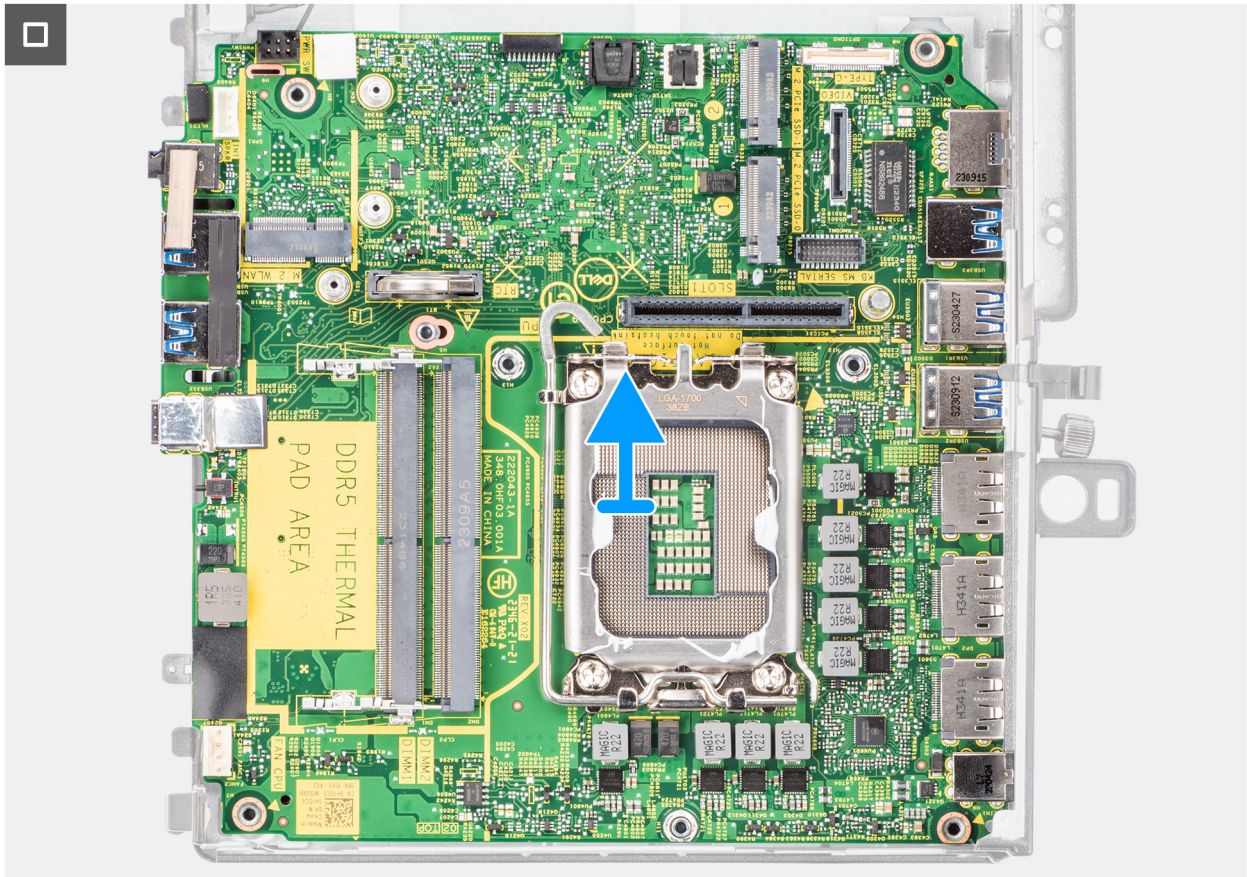

Figure 44. Removing the system board





**Figure 45. Removing the system board**

**Steps**

1. Remove the single screw (M3x5) that secures the speaker holder to the system board.
2. Lift and remove the speaker holder away from the system board.
3. Disconnect the power button cable from its connector on the system board.
4. Remove the screw (M3x4) and three screws (M3x5) that secure the system board to the chassis.
5. Slide and lift the system board away from the chassis.

## Installing the system board

**Prerequisites**

If you are replacing a component, remove the existing component before performing the installation procedure.

**About this task**

The following image indicates the connectors on your system board.

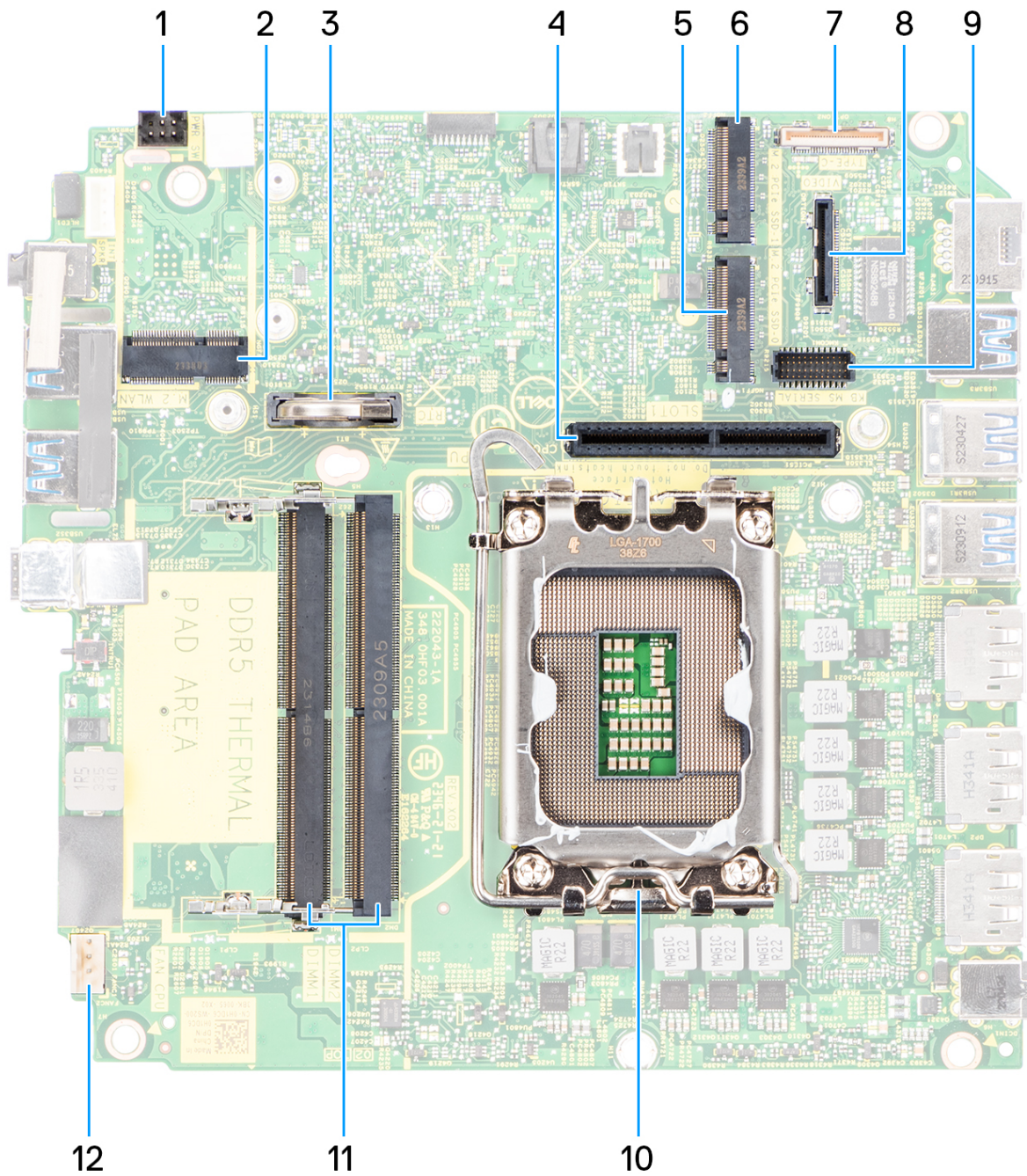

Figure 46. System board callout

Table 29. Precision 3280 CFF system board callouts

No	Connector	Description
1	PWR_SW	Power switch connector
2	M.2 WLAN	WLAN slot
3	RTC	Coin cell battery
4	PCIe riser connector	Riser support two PCIe Gen x8 open end connector(Electrically x8 for slot1, x1 for slot2)
5	M.2 PCIe SSD-0	M.2 PCIe SSD slot



**Table 29. Precision 3280 CFF system board callouts (continued)**

No	Connector	Description
6	M.2 PCIe SSD-1	M.2 PCIe SSD slot
7	TYPE-C	Type-C optional connector (USB 3.2 Gen 2 Type-C Port)
8	VIDEO	Optional video connector(VGA Port/Display Port 1.4a(HBR3)/HDMI 2.1 Port)
9	KB MS SERIAL	Optional PS/2,serial port connector
10	CPU	Processor socket
11	DIMM1 to DIMM2	Memory module connectors
12	FAN CPU	CPU fan connector

The following images indicate the location of the system board and provide a visual representation of the installation procedure.

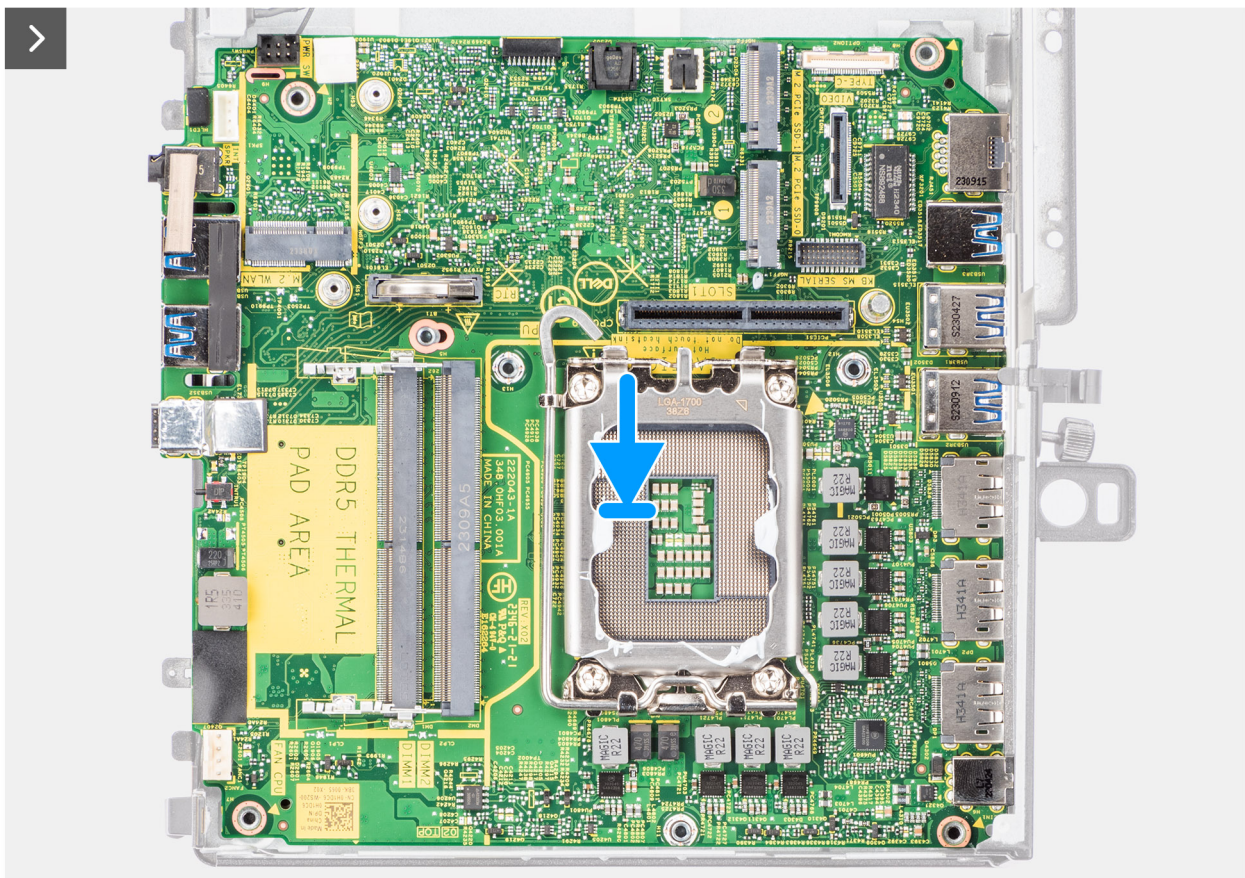

**Figure 47. Installing the system board**

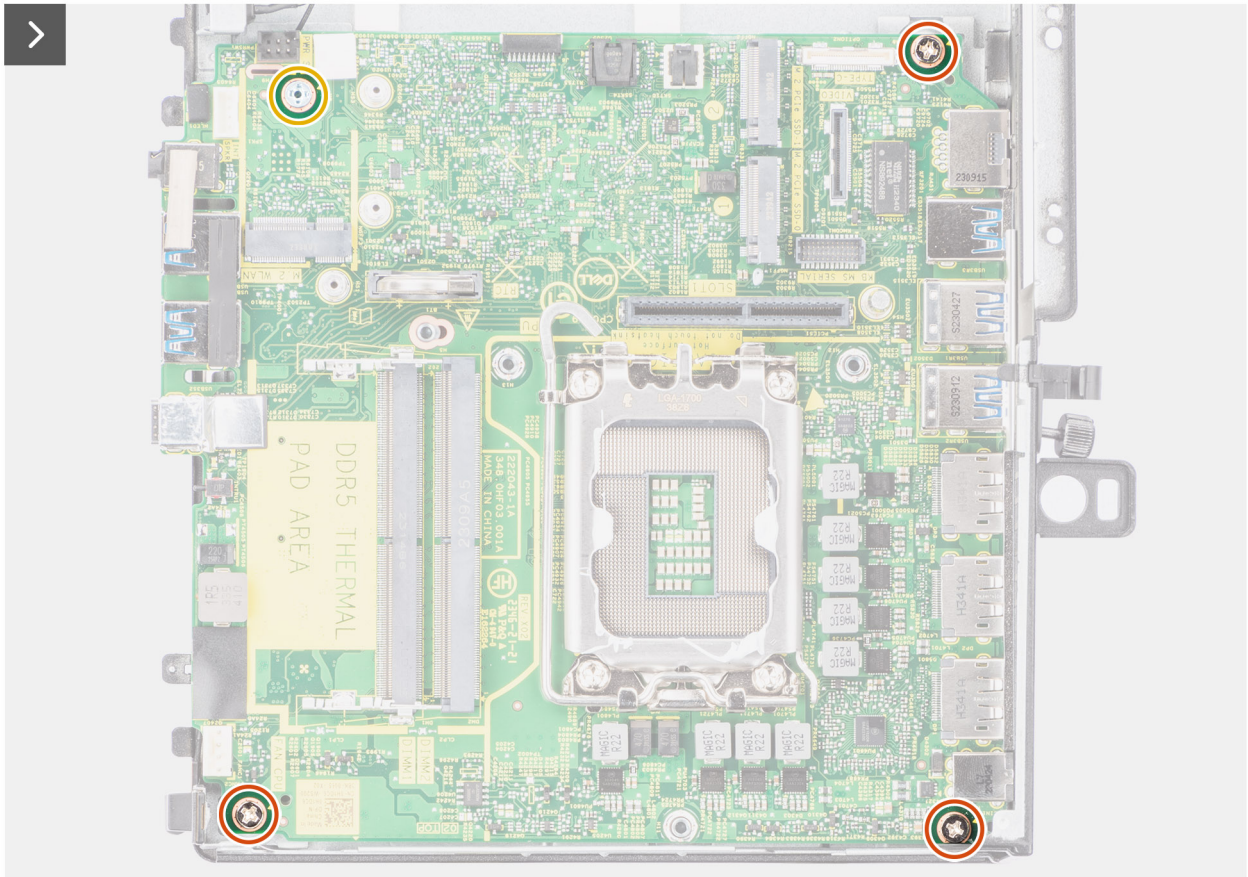

Figure 48. Installing the system board

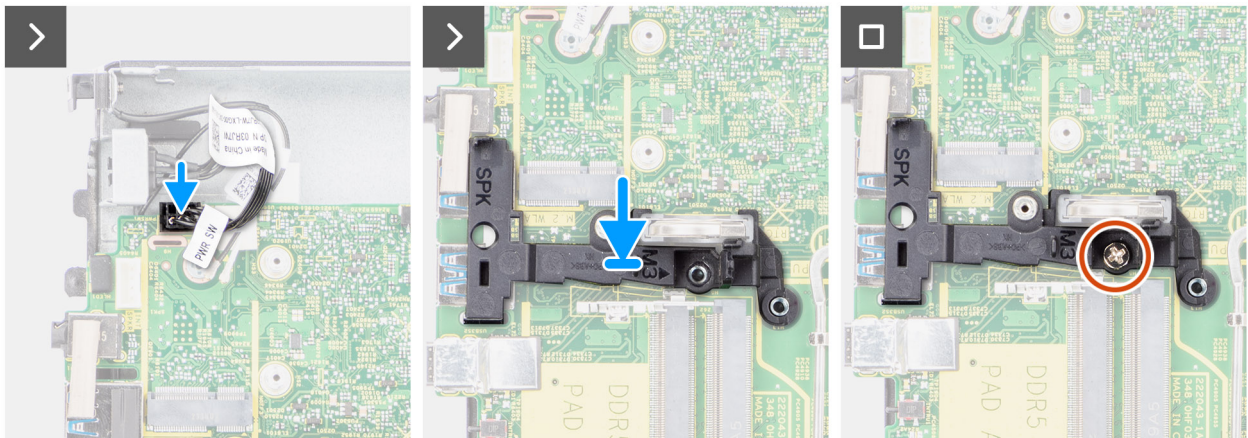

Figure 49. Installing the system board

**Steps**

1. Align the screw holes on the system board with screw holes on the chassis.
2. Replace the three screws (M3x5) and screw (M3x4) to secure the system board to the chassis.
3. Connect the power button cable to its connector on the system board.
4. Align the screw hole on the speaker holder with the screw hole on the system board.
5. Replace the screw (M3x5) to secure the speaker holder to the system board.

**Next steps**

1. Install the [processor](#).



2. Install the [heat sink](#).
3. Install the [processor fan](#).
4. Install the [speaker](#).
5. Install the [coin-cell battery](#).
6. Install the [wireless card](#).
7. Install the [M.2 2280 SSD \(slot-1\)](#) or [M.2 2280 SSD \(slot-2\)](#).
8. Install the [M.2 2230 SSD \(slot-1\)](#) or [M.2 2230 SSD \(slot-2\)](#).
9. Install the [riser-card module](#).
10. Install the [memory modules](#).
11. Install the [side cover](#).
12. Follow the procedure in [after working inside your computer](#).

## Power button

### Removing the power button

#### Prerequisites

1. Follow the procedure in [before working inside your computer](#).
2. Remove the [side cover](#).
3. Remove the [riser-card module](#).

#### About this task

The following images indicate the location of the power button and provide a visual representation of the removal procedure.

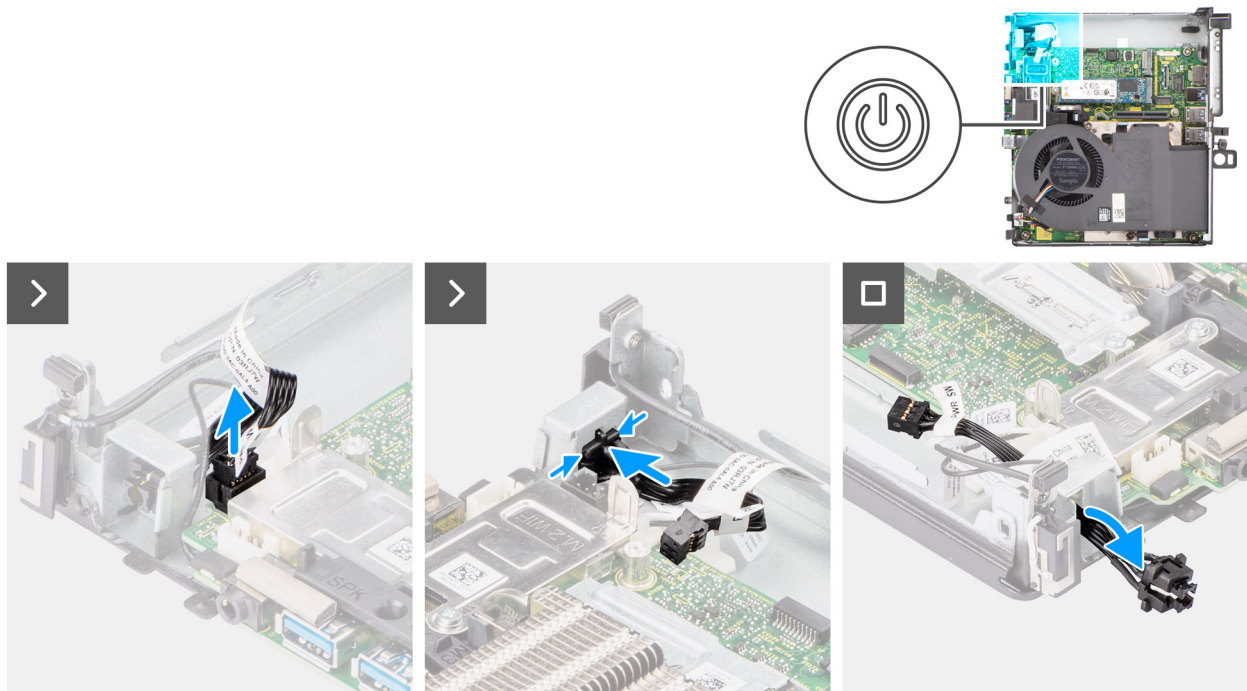

**Figure 50. Removing the power button**

#### Steps

1. Disconnect the power-button cable from the connector on the system board.
2. Press the release tabs on the power-button head and slide the power-button cable out from the front-side chassis of the system.
3. Pull the power-button cable out from the system.

# Installing the power button

## Prerequisites

If you are replacing a component, remove the existing component before performing the installation procedure.

## About this task

The following images indicate the location of the power button and provide a visual representation of the installation procedure.

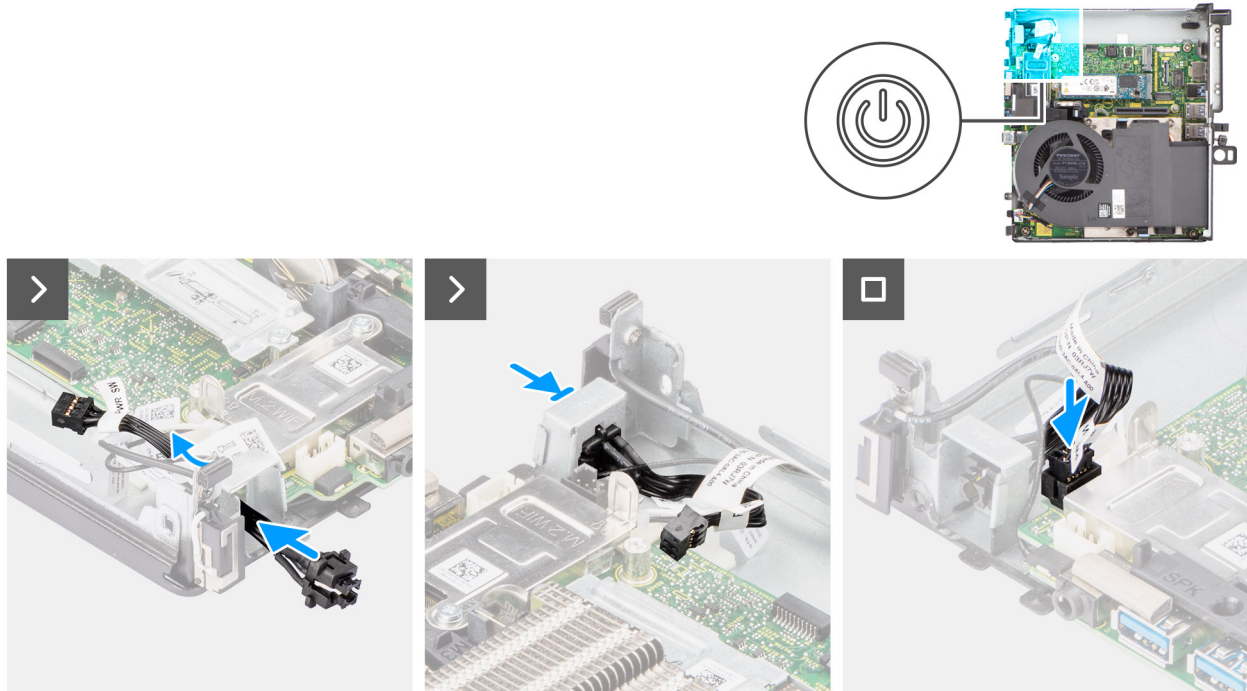

Figure 51. Installing the power button

## Steps

1. Insert the power-button cable into the slot from the front-side of the system, and press the power-button head until it clicks into the place in the chassis.
2. Align and connect the power-button cable to the connector on the system board.

## Next steps

1. Install the [riser-card module](#).
2. Install the [side cover](#).
3. Follow the procedure in [after working inside your computer](#).

# Internal antenna

## Removing the internal antenna—location 1

### Prerequisites

1. Follow the procedure in [before working inside your computer](#).
2. Remove the [side cover](#).
3. Remove the [riser-card module](#).



### About this task

The following images indicate the location of the internal antenna and provide a visual representation of the removal procedure.



Figure 52. Removing the internal antenna—location 1

### Steps

1. Remove the screw (M2x3.5) that secures the wireless-card shield to the system board.
2. Lift the wireless-card shield out of the system.
3. Remove the screw (M2x3.5) that secures the wireless-card bracket to the wireless card.
4. Disconnect the main antenna cable from the wireless card.
5. Remove the antenna cable from the routing guides under the EMI shielding along with the chassis using a plastic scribe.
6. Remove the screw (M3x3) that secures the internal antenna module to the chassis.
7. Pull to remove the internal antenna module away from the chassis.

## Installing the internal antenna—location 1

### Prerequisites

If you are replacing a component, remove the existing component before performing the installation procedure.

**About this task**

The following images indicate the location of the Internal antenna and provide a visual representation of the installation procedure.

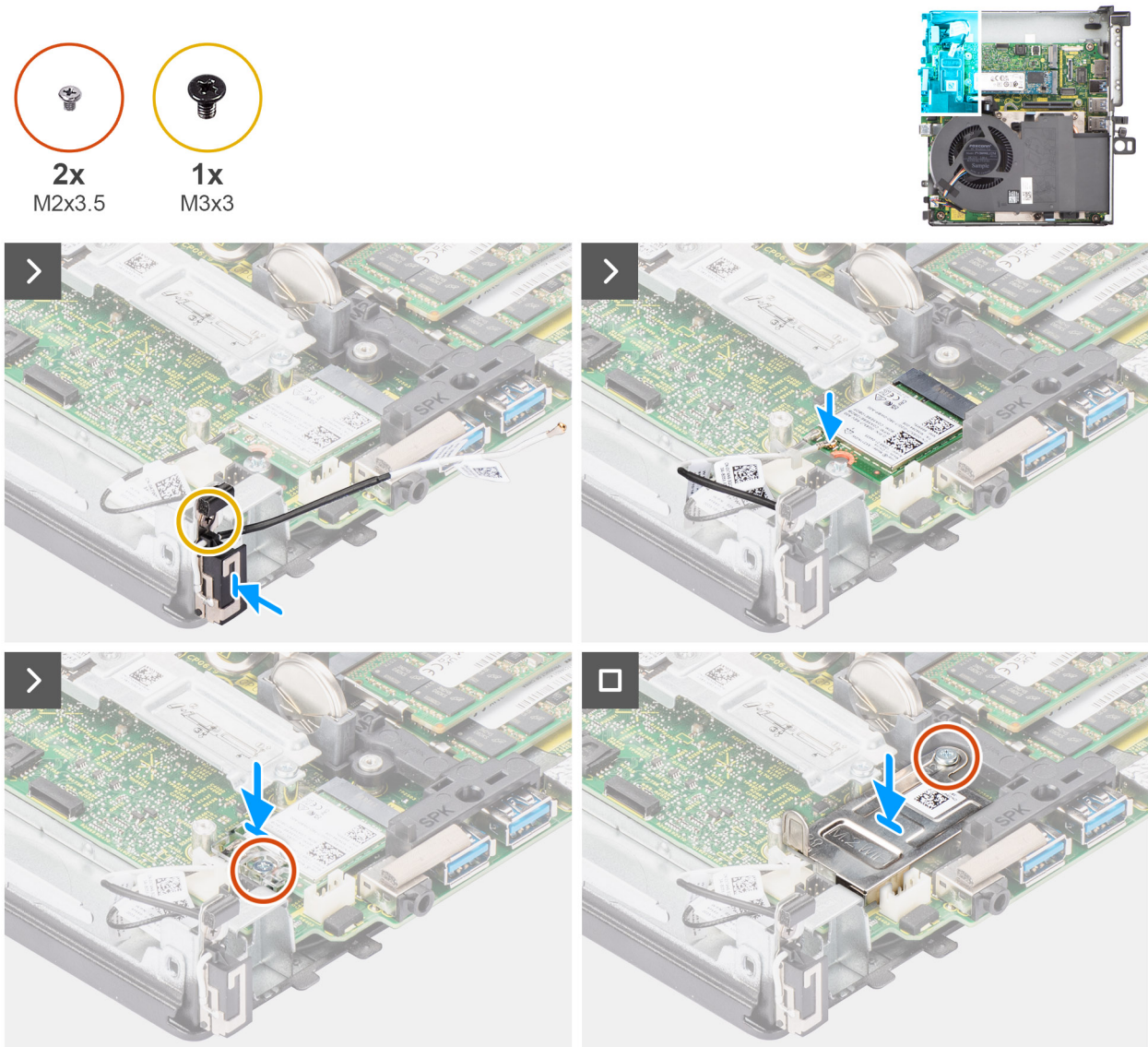

**Figure 53. Installing the internal antenna—location 1**

**Steps**

1. Align and insert the internal antenna module into its slot on the chassis.
2. Replace the screw (M3x3) to secure the internal antenna module to the chassis.
3. Route the antenna cable through the metallic routing guides under the EMI shielding along with the chassis using a plastic scribe.
4. Connect the main antenna cable to the wireless card.

The following table provides the antenna-cable color scheme for the WLAN card of your system.

**Table 30. Antenna-cable color scheme**

Connectors on the wireless card	Antenna-cable color	Silkscreen marking	
Main	White	MAIN	△ (white triangle)

5. Place the wireless-card bracket on the wireless card.

6. Replace the screw (M2x3.5) to secure the wireless card and wireless-card bracket to the system board.
7. Align and place the wireless-card shield on the system board and wireless card.
8. Replace the screw (M2x3.5) to secure the wireless-card shield to the system board.

#### **Next steps**

1. Install the [riser-card module](#).
2. Install the [side cover](#).
3. Follow the procedure in [after working inside your computer](#).

## **Removing the internal antenna—location 2**

#### **Prerequisites**

1. Follow the procedure in [before working inside your computer](#).
2. Remove the [side cover](#).
3. Remove the [riser-card module](#).

#### **About this task**

The following images indicate the location of the internal antenna and provide a visual representation of the removal procedure.





Figure 54. Removing the internal antenna—location 2

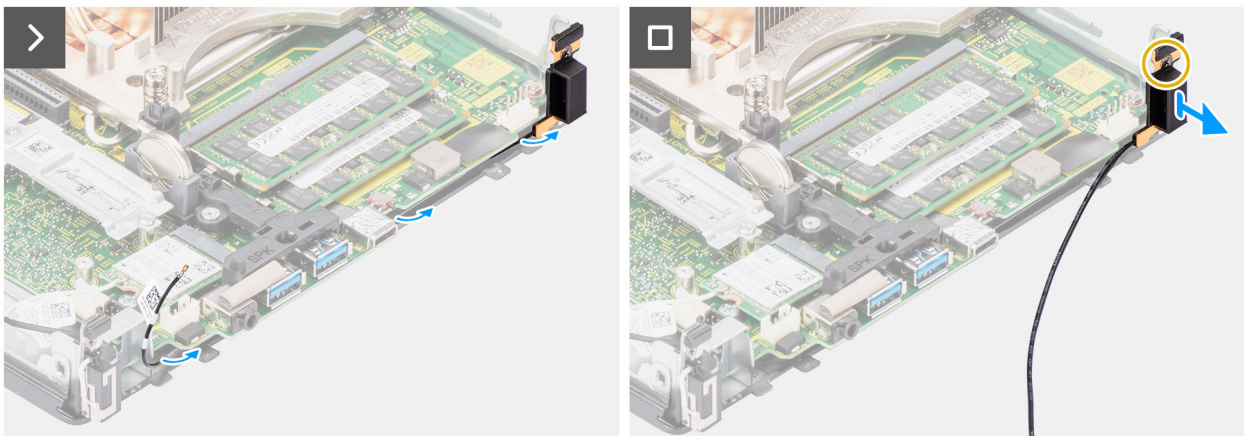

Figure 55. Removing the internal antenna—location 2

**Steps**

1. Pry the metallic routing guide and unroute the antenna cables from the chassis.

2. Remove the single screw (M3x3) that secures the internal antennae to the chassis.
3. Lift and remove the internal antennae away from the computer.
4. Remove the screw (M2x3.5) that secures the wireless-card shield to the system board.
5. Lift the wireless-card shield out of the system.
6. Remove the screw (M2x3.5) that secure the wireless-card bracket to the wireless card.
7. Disconnect the auxiliary antenna cable from the wireless card.
8. Remove the antenna cable from the routing guides in the chassis using a plastic scribe.
9. Remove the screw (M3x3) that secures the internal antenna module to the chassis.
10. Pull to remove the internal antenna module away from the chassis.

## Installing the internal antenna—location 2

### Prerequisites

If you are replacing a component, remove the existing component before performing the installation procedure.

### About this task

The following images indicate the location of the Internal antenna and provides a visual representation of the installation procedure.

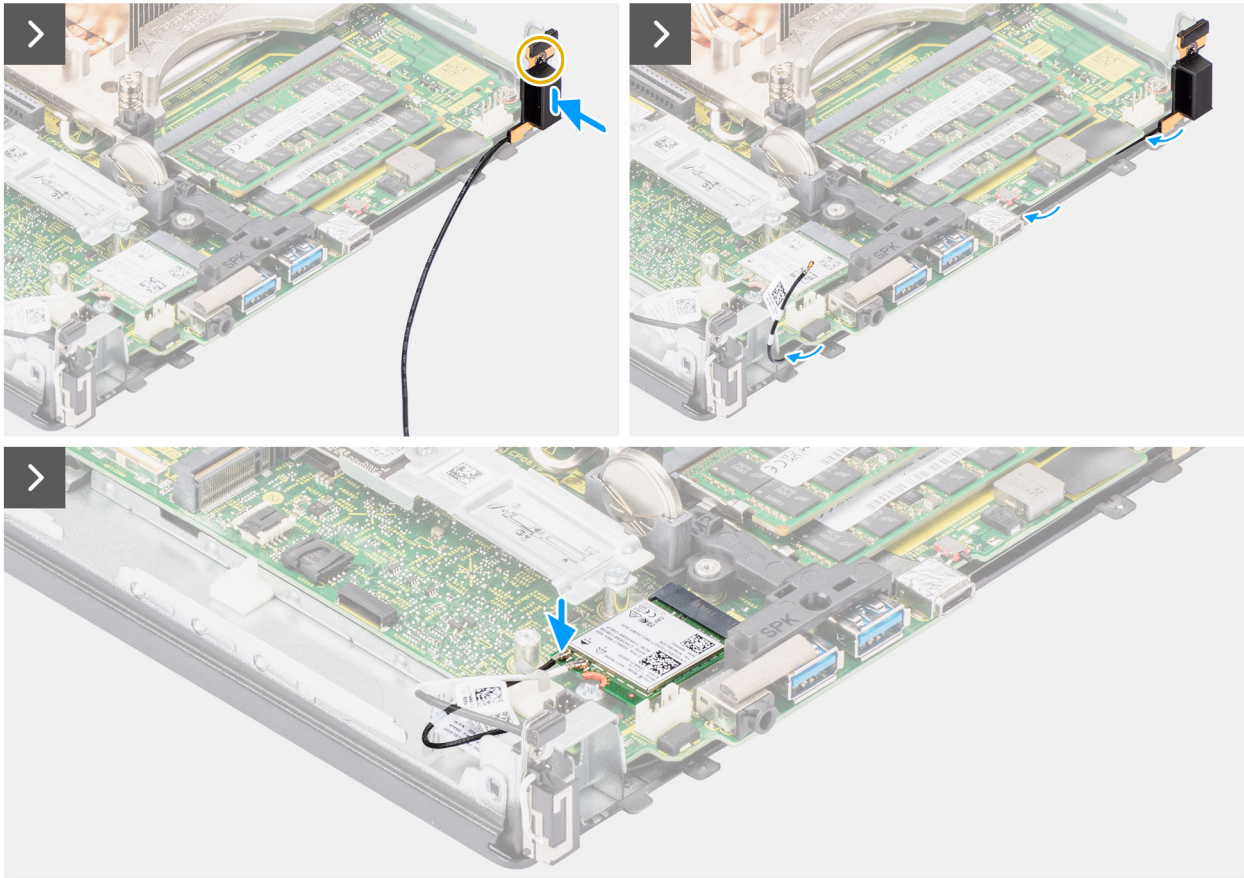

Figure 56. Installing the internal antenna—location 2

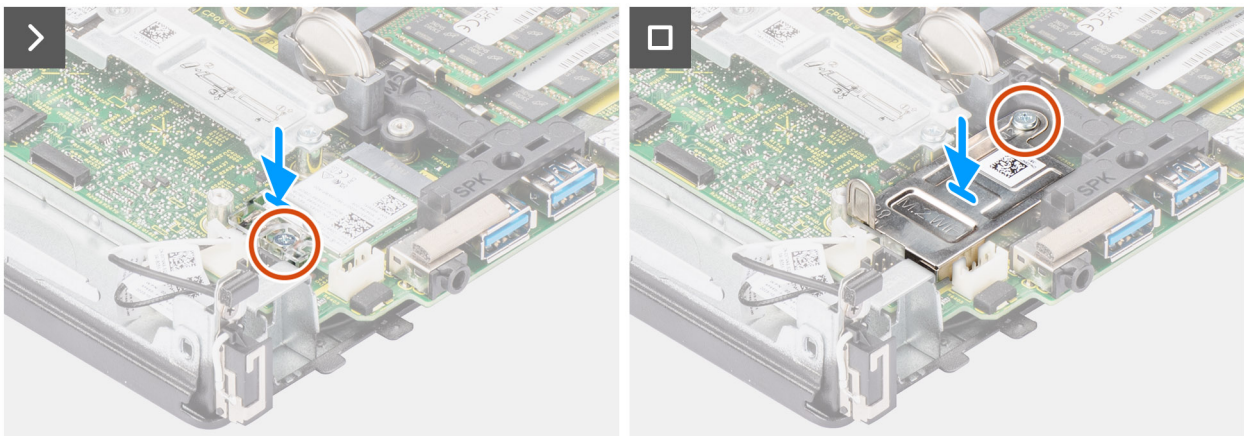

Figure 57. Installing the internal antenna—location 2

**Steps**

1. Replace the single screw (M3x3) to secure the internal antennae to the chassis.



2. Route the auxiliary antenna cable through the metallic routing guide on the chassis.
3. Align and insert the internal antenna module into its slot on the chassis.
4. Replace the screw (M3x3) to secure the internal antenna module to the chassis.
5. Route the auxiliary antenna cable through the metallic routing guide on the chassis using a plastic scribe.
6. Connect the auxiliary antenna cable to the wireless card.

The following table provides the antenna-cable color scheme for the WLAN card of your system.

**Table 31. Antenna-cable color scheme**

Connectors on the wireless card	Antenna-cable color	Silkscreen marking	
Auxiliary	Black	AUX	▲ (black triangle)

7. Place the wireless-card bracket on the wireless card.
8. Replace the screw (M2x3.5) to secure the wireless card and wireless-card bracket to the system board.
9. Align and place the wireless-card shield on the system board and wireless card.
10. Replace the screw (M2x3.5) to secure the wireless-card shield to the system board.

**Next steps**

1. Install the [riser-card module](#).
2. Install the [side cover](#).
3. Follow the procedure in [after working inside your computer](#).

# Software

This chapter details the supported operating systems along with instructions on how to install the drivers.

## Operating system

Your Precision 3280 CFF supports the following operating systems:

- Windows 11 Home, 64-bit
- Windows 11 Pro, 64-bit
- Windows 11 Pro National Education, 64-bit
- Windows 11 Pro for Workstations
- Red Hat Linux 9.4 Enterprise
- Ubuntu Linux 22.04 LTS, 64-bit

## Drivers and downloads

When troubleshooting, downloading, or installing drivers, it is recommended that you read the Dell Knowledge Base article Drivers and Downloads FAQs [000123347](#).

# Technology and components

**NOTE:** Instructions that are provided in the following section are applicable on computers that are shipped with the Windows operating system. Windows is factory-installed with this computer.

## System management features

Dell commercial systems come with several systems management options that are included by default for In-Band management with our Dell Client Command Suite. In-Band management meaning that the Operating System is functional, and the device is connected to a network so that it can be managed. The Dell Client Command Suite of tools can be leveraged individually or with a systems management console like SCCM, LANDESK, KACE.

We also offer Out-of-Band management as an option. Out-of-band management is when the system does not have a functional operating system or is turned off and you still want to be able to manage the system in that state.

## Dell Client Command Suite for in-band systems management

**Dell Client Command Suite** is a free toolkit available for download, for all Latitude Rugged tablets at [dell.com/support](http://dell.com/support), that automates and streamlines systems management tasks, saving time, money, and resources. It consists of the following modules that can be used independently, or with a variety of systems management consoles such as SCCM.

Dell Client Command Suite's integration with VMware Workspace ONE Powered by AirWatch, now allows customers to manage their Dell client hardware from the cloud, using a single Workspace ONE console.

**Dell Command | Deploy** enables easy operating system (OS) deployment across all major OS deployment methodologies and provides numerous system-specific drivers that have been extracted and reduced to an OS-consumable state.

**Dell Command | Configure** is a graphical user interface (GUI) admin tool for configuring and deploying hardware settings in a pre-OS or post-OS environment, and it operates seamlessly with SCCM and Airwatch and can be self-integrated into LANDesk and KACE. Simply, this is all about the BIOS. Command | Configure allows you to remotely automate and configure over 150+ BIOS settings for a personalized user experience.

**Dell Command | PowerShell Provider** can do the same things as Command | Configure, but with a different method. PowerShell is a scripting language that allows customers to create a customized and dynamic configuration process.

**Dell Command | Monitor** is a Windows Management Instrumentation (WMI) agent that provides IT admins with an extensive inventory of the hardware and health-state data. Admins can also configure hardware remotely by using command line and scripting.

**Dell Command | Update (end-user tool)** is factory-installed and allows admins to individually manage and automatically present and install Dell updates to the BIOS, drivers, and software. Command | Update eliminates the time-consuming hunting and pecking process of update installation.

**Dell Command | Update Catalog** provides searchable metadata that allows the management console to retrieve the latest system-specific updates (driver, firmware or BIOS). The updates are then delivered seamlessly to end-users using the customer's systems management infrastructure that is consuming the catalog (like SCCM).

**Dell Command | vPro Out of Band** console extends hardware management to systems that are offline or have an unreachable OS (Dell exclusive features).

**Dell Command | Integration Suite for System Center** - This suite integrates all the key components of the Client Command Suite into Microsoft System Center Configuration Manager 2012 and Current Branch versions.

## Out-of-band systems management

Intel Standard Manageability option **must be configured in our factory at the time of purchase, as it is NOT field upgradable.** It offers out-of-band management and DASH compliance ([Certification Registry](#)).

# BIOS Setup

**CAUTION:** Unless you are an expert computer user, do not change the settings in the BIOS Setup. Certain changes can make your computer work incorrectly.

**NOTE:** Depending on the computer and the installed devices, the options that are listed in this section may or may not be displayed.

**NOTE:** Before you change the settings in BIOS Setup, it is recommended that you note down the original settings for future reference.

Use BIOS Setup for the following purposes:

- Get information about the hardware installed in your computer, such as the amount of RAM and the size of the storage device.
- Change the system configuration information.
- Set or change a user-selectable option, such as the user password, type of hard drive installed, and enable or disable base devices.

## Entering BIOS Setup program

### About this task

Turn on (or restart) your computer and press F2 immediately.

## Navigation keys

**NOTE:** For most of the BIOS Setup options, changes that you make are recorded but do not take effect until you restart the computer.

**Table 32. Navigation keys**

Keys	Navigation
Up arrow	Moves to the previous field.
Down arrow	Moves to the next field.
Enter	Selects a value in the selected field (if applicable) or follows the link in the field.
Spacebar	Expands or collapses a drop-down list, if applicable.
Tab	Moves to the next focus area.
Esc	Moves to the previous page until you view the main screen. Pressing Esc in the main screen displays a message that prompts you to save any unsaved changes and restart the computer.

## One time boot menu

To access the **one time boot menu**, turn on your computer, and then press F2 immediately.

**NOTE:** If your computer fails to enter the boot menu, restart the computer and press F2 immediately.

The one-time boot menu displays the devices that you can boot from, and also displays the option to start diagnostics. The boot menu options are:

- Removable Drive (if available)
- STXXXX Drive (if available)
- **i** **NOTE:** XXX denotes the SATA drive number.
- Optical Drive (if available)
- SATA Hard Drive (if available)
- Diagnostics
- **i** **NOTE:** Choosing **Diagnostics**, will display the **ePSA diagnostics** screen.

The **one time boot menu** also displays the option to access the System Setup screen.

## System setup options

**i** **NOTE:** Depending on your computer and its installed devices, the items that are listed in this section may or may not appear.

**Table 33. System setup options—System information menu**

Overview	
<b>Precision 3280 CFF</b>	
BIOS Version	Displays the BIOS version number.
Service Tag	Displays the Service Tag of the computer.
Asset Tag	Displays the Asset Tag of the computer.
Manufacture Date	Displays the manufacture date of the computer.
Ownership Date	Displays the ownership date of the computer.
Express Service Code	Displays the express service code of the computer.
Ownership Tag	Displays the Ownership Tag of the computer.
Signed Firmware Update	Displays whether the Signed Firmware Update is enabled on your computer.
<b>Processor Information</b>	
Processor Type	Displays the processor type.
Maximum Clock Speed	Displays the maximum processor clock speed.
Minimum Clock Speed	Displays the minimum processor clock speed.
Current Clock Speed	Displays the current processor clock speed.
Core Count	Displays the number of cores on the processor.
Processor ID	Displays the processor identification code.
Processor L2 Cache	Displays the processor L2 Cache size.
Processor L3 Cache	Displays the processor L3 Cache size.
HT Capable	Displays the HT capable information.
64-Bit Technology	Displays whether 64-bit technology is used.
<b>Memory Information</b>	
Memory Installed	Displays the total computer memory installed.
Memory Available	Displays the total computer memory available.
Memory Speed	Displays the memory speed.
Memory Channel Mode	Displays single or dual channel mode.
Memory Technology	Displays the technology that is used for the memory.



**Table 33. System setup options—System information menu (continued)**

<b>Overview</b>	
DIMM 1 Size	Displays the DIMM 1 memory size.
DIMM 2 Size	Displays the DIMM 2 memory size.
<b>Devices Information</b>	
Video Controller	Displays the video controller type of the computer.
Video Memory	Displays the video memory information of the computer.
Wi-Fi Device	Displays the wireless device information of the computer.
Native Resolution	Displays the native resolution of the computer.
Video BIOS Version	Displays the video BIOS version of the computer.
Audio Controller	Displays the audio controller information of the computer.
Bluetooth Device	Displays the Bluetooth device information of the computer.
LOM MAC Address	Displays the LAN On Motherboard (LOM) MAC address of the computer.
dGPU Video Controller	Displays the discrete video controller type of the computer.
Slot 0	Displays the SATA hard drive information of the computer.

**Table 34. System setup options—Boot Configuration menu**

<b>Boot Configuration</b>	
<b>Boot Sequence</b>	
Boot Mode: UEFI only	Displays the boot mode.
Boot Sequence	Displays the boot sequence.
<b>Force PXE On Next Boot</b>	Enable or disable the Force PXE on Next Boot option. By default, the option is not enabled.
<b>Secure Boot</b>	
Enable Secure Boot	Enable or disable the secure boot feature. By default, the option is not enabled.
Secure Boot Mode	Enable or disable to change the secure boot mode options. By default, the <b>Deployed Mode</b> is enabled.
<b>Expert Key Management</b>	
Enable Custom Mode	Enable or disable custom mode. By default, the <b>custom mode</b> option is not enabled.
Custom Mode Key Management	Select the custom values for expert key management.

**Table 35. System setup options—Integrated Devices menu**

<b>Integrated Devices</b>	
<b>Date/Time</b>	Displays the current date in MM/DD/YYYY format and current time in HH:MM:SS AM/PM format.
<b>Audio</b>	
Enable Audio	Enable or disable the integrated audio controller. By default, all the options are enabled.
<b>USB Configuration</b>	<ul style="list-style-type: none"> <li>Enable or disable booting from USB mass storage devices through the boot sequence or boot menu.</li> </ul>

**Table 35. System setup options—Integrated Devices menu (continued)**

Integrated Devices	
	By default, all the options are enabled.
<b>Front USB Configuration</b>	Enable or disable the individual front USB ports. By default, all the options are enabled.
<b>Rear USB Configuration</b>	Enable or disable the individual rear USB ports. By default, all the options are enabled.
<b>Miscellaneous Devices</b>	Enable or disable the PCI Slot By default, the option is enabled.

**Table 36. System setup options—Storage menu**

Storage	
<b>SATA/NVMe Operation</b>	Enable or disable the operating mode of the integrated SATA/NVMe storage device controller. By default, the <b>RAID On</b> option is enabled.
<b>Storage Interface</b>	
Port Enablement	Enable or disable the onboard drives. By default, all the options are enabled.
<b>SMART Reporting</b>	
Enable SMART Reporting	Enable or disable Self-Monitoring, Analysis, and Reporting Technology (SMART) during computer startup. By default, the <b>Enable SMART Reporting</b> option is not enabled.
<b>Drive Information</b>	
<b>SATA-0</b>	
Type	Displays the SATA HDD type information of the computer.
Device	Displays the SATA HDD device information of the computer.
<b>M.2 PCIe SSD-0</b>	
Type	Displays the M.2 PCIe SSD-0 type information of the computer.
Device	Displays the M.2 PCIe SSD-0 device information of the computer.
<b>M.2 PCIe SSD-1</b>	
Type	Displays the M.2 PCIe SSD-1 type information of the computer.
Device	Displays the M.2 PCIe SSD-1 device information of the computer.

**Table 37. System setup options—Display menu**

Display	
<b>Primary Display</b>	
Video Primary Display	Determines the primary display when multiple controllers are available on the computer. By default, the <b>Auto</b> option is enabled.
<b>Full Screen Logo</b>	Enable or disable full screen logo. By default, the option is not enabled.

**Table 38. System setup options—Connection menu**

Connection	
<b>Network Controller Configuration</b>	
Integrated NIC	Controls the on-board LAN controller. By default, the <b>Enabled with PXE</b> option is enabled.
<b>Wireless Device Enable</b>	
WLAN	Enable or disable the internal WLAN device By default, the option enabled.
Bluetooth	Enable or disable the internal Bluetooth device By default, the option enabled.
<b>Enable UEFI Network Stack</b>	
	Enable or disable UEFI Network Stack and controls the on-board LAN Controller. By default, the <b>Auto Enabled</b> option is enabled.
<b>HTTPs Boot Feature</b>	
HTTPs Boot	Enable or disable the HTTPs Boot feature. By default, the <b>HTTPs Boot</b> option is enabled.
HTTPs Boot Mode	With Auto Mode, the HTTPs Boot extracts Boot URL from the DHCP. With Manual Mode, the HTTPs Boot reads Boot URL from the user-provided data. By default, the <b>Auto Mode</b> option is enabled.

**Table 39. System setup options—Power menu**

Power	
<b>USB PowerShare</b>	
Enable USB PowerShare	Enable or disable the USB PowerShare. By default, the <b>Enable USB PowerShare</b> option is enabled
<b>Thermal Management</b>	
	Enables cooling fan and processor heat management to adjust the computer performance, noise, and temperature. By default, the <b>Optimized</b> option is enabled.
<b>USB Wake Support</b>	
Enable USB Wake Support	When enabled, you can use the USB devices like a mouse or keyboard to wake your computer from standby. By default, the option is enabled.
<b>AC Behavior</b>	
AC Recovery	Enables the system to turn on automatically, when AC is inserted. By default, the <b>Power Off</b> option is enabled.
<b>Active State Power Management</b>	
Aspm	Enables or disables the Active State Power Management (ASPM) level By default, the <b>Auto</b> option is enabled.
<b>Block Sleep</b>	
	Enables to block entering sleep (S3) mode in the operating system. By default, the <b>Block Sleep</b> option is disabled.
<b>Deep Sleep Control</b>	
	Enable or disable the Deep Sleep mode support. By default, the <b>Disabled</b> option is enabled.

**Table 39. System setup options—Power menu (continued)**

Power	
<b>Intel Speed Shift Technology</b>	<p>Enable or disable the Intel speed shift technology support.</p> <p>By default, the <b>Intel Speed Shift Technology</b> option is enabled.</p>

**Table 40. System setup options—Security menu**

Security	
<b>TPM 2.0 Security</b>	
TPM 2.0 Security On	<p>Enable or disable TPM 2.0 security options.</p> <p>By default, the <b>TPM 2.0 Security On</b> option is enabled.</p>
Attestation Enable	<p>Enables to control whether the Trusted Platform Module (TPM) Endorsement Hierarchy is available to the operating system.</p> <p>By default, the <b>Attestation Enable</b> option is enabled.</p>
Key Storage Enable	<p>Enables to control whether the Trusted Platform Module (TPM) Storage Hierarchy is available to the operating system.</p> <p>By default, the <b>Key Storage Enable</b> option is enabled.</p>
SHA-256	<p>BIOS and the TPM will use the SHA-256 hash algorithm to extend measurements into the TPM PCRs during BIOS boot.</p> <p>By default, the <b>SHA-256</b> option is enabled.</p>
Clear	<p>Enables to clear the TPM owner information and returns the TPM to the default state.</p> <p>By default, the <b>Clear</b> option is disabled.</p>
PPI ByPass for Clear Commands	<p>Controls the TPM Physical Presence Interface (PPI).</p> <p>By default, the <b>PPI ByPass for clear Commands</b> option is disabled.</p>
<b>Chassis intrusion</b>	
	<p>Controls the chassis intrusion feature.</p> <p>By default, the option is disabled.</p>
<b>SMM Security Mitigation</b>	
	<p>Enable or disable SMM Security Mitigation.</p> <p>By default, the option is enabled.</p>
<b>Data Wipe on Next Boot</b>	
Start Data Wipe	<p>Enable or disable the data wipe on next boot.</p> <p>By default, the option is disabled.</p>
Absolute	<p>Enable or disable or permanently disable the BIOS module interface of the optional Absolute Persistence Module service from Absolute software.</p> <p>By default, the <b>Enable Absolute</b> option is enabled.</p>
UEFI Boot Path Security	<p>Controls whether or not the computer will prompt the user to enter the admin password (if set) when booting to a UEFI boot device from the F12 boot menu.</p> <p>By default, the <b>Always Except Internal HDD</b> option is enabled.</p>
<b>HDD Security</b>	
SED Block SID Authentication	<p>Controls a mechanism used by the BIOS to block the entities from taking ownership of the SED when the drive does not have a password set.</p> <p>By default, the option is enabled.</p>
PPI ByPass for SED Block SID Command	<p>Controls the SED Block SID Physical Presence Interface(PPI).</p> <p>By default, this option is disabled.</p>

**Table 40. System setup options—Security menu (continued)**

Security	
Absolute	Enable or disable or permanently disable the BIOS module interface of the optional Absolute Persistence Module service from Absolute software.  By default, the <b>Enable Absolute</b> option is enabled.
<b>UEFI Boot Path Security</b>	Controls whether or not the computer will prompt the you to enter the admin password when booting to a UEFI boot path device from the F12 boot menu.  By default, the <b>Always Except Internal HDD</b> option is enabled.
<b>Authenticated BIOS Interface</b>	
Enable Authenticated BIOS Interface	Enable or disable the Authenticated BIOS Interface option.  By default, the option is disabled.
<b>Legacy Manageability Interface Access</b>	Allows the platform administrator to control access through the Legacy Manageability Interface when ABI is enabled and provisioned.  By default, the option is enabled.

**Table 41. System setup options—Passwords menu**

Passwords	
<b>Admin Password</b>	Set, change, or delete the administrator password.
<b>System Password</b>	Set, change, or delete the computer password.
<b>M.2 PCIe SSD-0</b>	Set, change, or delete the M.2 PCIe SSD0 password.
<b>Password Configuration</b>	
Upper Case Letter	Reinforces password must have at least one upper case letter.  By default, the option is disabled.
Lower Case Letter	Reinforces password must have at least one lower case letter.  By default, the option is disabled.
Digit	Reinforces password must have at least one digit.  By default, the option is disabled.
Special Character	Reinforces password must have at least one special character.  By default, the option is disabled.
Minimum Characters	Set the minimum characters allowed for password.
<b>Password Bypass</b>	When enabled, this always prompts for computer and internal hard drive passwords when powered on from the off state.  By default, the <b>Disabled</b> option is enabled.
<b>Password Changes</b>	
Allow Non-Admin Password Changes	Enable or disable to change computer and hard drive password without the need for admin password.  By default, the option is enabled.
<b>Admin Setup Lockout</b>	
Enable Admin Setup Lockout	Enables administrators control over how their users can or cannot access BIOS setup.  By default, the option is disabled.
<b>Master Password Lockout</b>	
Enable Master Password Lockout	When enabled, this will disable the master password support.



**Table 41. System setup options—Passwords menu (continued)**

Passwords	
	By default, the option is disabled.
<b>Allow Non-Admin PSID Revert</b>	
Enable Allow Non-Admin PSID Revert	Controls access to the Physical Security ID (PSID) revert of NVMe hard-drives from the Dell Security Manager prompt. By default, the option is disabled.

**Table 42. System setup options—Update, Recovery menu**

Update, Recovery	
<b>UEFI Capsule Firmware Updates</b>	Enable or disable BIOS updates through UEFI capsule update packages. By default, the option is enabled.
<b>BIOS Recovery from Hard Drive</b>	Enables the user to recover from certain corrupted BIOS conditions from a recovery file on the user primary hard drive or an external USB key. By default, the option is enabled.
<b>BIOS Downgrade</b>	
Allow BIOS Downgrade	Enable or disable the flashing of the computer firmware to previous revision is blocked. By default, the option is enabled.
<b>SupportAssist OS Recovery</b>	Enable or disable the boot flow for SupportAssist OS Recovery tool in the event of certain computer errors. By default, the option is enabled.
<b>BIOSConnect</b>	Enable or disable cloud Service OS recovery if the main operating system fails to boot with the number of failures equal to or greater than the value specified by the Auto OS Recovery Threshold setup option and local Service OS does not boot or is not installed. By default, the option is enabled.
<b>Dell Auto OS Recovery Threshold</b>	Controls the automatic boot flow for SupportAssist System Resolution Console and for Dell OS Recovery Tool. By default, the threshold value is set to 2.

**Table 43. System setup options—System Management menu**

System Management	
<b>Service Tag</b>	Display the Service Tag of the computer.
<b>Asset Tag</b>	Create a computer Asset Tag.
<b>Wake on LAN/WLAN</b>	Enable or disable the computer to power on by special LAN signals when it receives a wakeup signal from the WLAN. By default, the <b>Disabled</b> option is selected.
<b>Auto on Time</b>	Enable to set the computer to turn on automatically every day or on a preselected date and time. This option can be configured only if the Auto On Time is set to Everyday, Weekdays, or Selected Days. By default, the option is disabled.
<b>Intel AMT Capability</b>	
Enable Intel AMT Capability	Enable or disable the Intel AMT capability. By default, the <b>Restrict Preboot Access</b> option is enabled.

**Table 43. System setup options—System Management menu (continued)**

System Management	
<b>SERR Messages</b>	Enable or disable SERR messages. By default, the option is enabled.
<b>First Power On Date</b>	
Set Ownership Date	Allows to set the Ownership date. By default, the option is disabled.
<b>Diagnostic</b>	
OS Agent Requests	Enable or disable the Dell OS Agent(s) capability of scheduling onboard diagnostics on a subsequent boot which helps assist in the prevention and resolution of hardware related issues. By default, this option is enabled.
<b>Power-on-Self-Test Automatic Recovery</b>	Enable or disable the Power-on-Self-Test automatic recovery option. By default, the option is enabled.

**Table 44. System setup options—Keyboard menu**

Keyboard	
<b>Keyboard Errors</b>	
Enable Keyboard Error Detection	Enable or disable the keyboard error detection. By default, the option is enabled.
<b>Numlock LED</b>	
Enable Numlock LED	Enable or disable Numlock LED. By default, the option is enabled.
<b>Device Configuration Hotkey Access</b>	
Device Configuration Hotkey Access	Enable or disable users to access device configuration by using hotkeys. By default, the option is enabled.

**Table 45. System setup options—Pre-boot Behavior menu**

Pre-boot Behavior	
<b>Adapter Warnings</b>	
Enable Adapter Warnings	Enable or disable the adapter warning messages. By default, the option is enabled.
<b>Warning and Errors</b>	Enable or disable the action to be done when a warning or error is encountered. By default, the <b>Prompt on Warnings and Errors</b> option is enabled.
<b>Fastboot</b>	Enable to set the speed of the boot process. By default, the <b>Minimal</b> option is enabled.
<b>Extend BIOS POST Time</b>	Set the BIOS POST time. By default, the <b>0 seconds</b> option is enabled.

**Table 46. System setup options—Virtualization menu**

Virtualization	
<b>Intel Virtualization Technology</b>	

**Table 46. System setup options—Virtualization menu (continued)**

<b>Virtualization</b>	
Enable Intel Virtualization Technology (VT)	Specify whether a Virtual Machine Monitor (VMM) can utilize the additional hardware capabilities that are provided by Intel Virtualization Technology.  By default, the option is enabled.
<b>VT for Direct I/O</b>	Specify whether a Virtual Machine Monitor (VMM) can utilize the additional hardware capabilities that are provided by Intel Virtualization Technology for Direct I/O.  By default, the option is enabled.
<b>DMA Protection</b>	
Enable Pre-Boot DMA Support	Controls the Pre-boot DMA protection for both internal and external ports.  By default, the option is enabled.
Enable OS Kernal DMA Support	Controls the Kernal DMA protection for both internal and external ports.  By default, the option is enabled.

**Table 47. System setup options—Performance menu**

<b>Performance</b>	
<b>Multi Core Support</b>	
Active Cores	Enables to change the number of CPU cores available to the operating system.  By default, the <b>All Cores</b> options are enabled.
<b>Intel SpeedStep</b>	
Enable Intel SpeedStep Technology	Enables the computer to dynamically adjust processor voltage and core frequency, decreasing average power consumption and heat production.  By default, the option is enabled.
<b>C-States Control</b>	
Enable C-State Control	Enable or disable additional processor sleep states.  By default, the option is enabled.
<b>Intel Turbo Boost Technology</b>	
Enable Intel Turbo Boost Technology	Enable or disable Intel TurboBoost mode of the processor.  By default, the option is enabled.
<b>Intel Hyper-Threading Technology</b>	
Enable Intel Hyper-Threading Technology	Enable or disable Hyper-Threading in the processor.  By default, the option is enabled.
<b>Pcie Link Speed</b>	
	Enable to select the maximum PCIe link speed attainable by devices with the computer.  By default, the <b>Auto</b> option is enabled.
<b>PCIe Resizable Base Address Register (BAR)</b>	Enable or disable the PCIe resizable base address register support.  By default, the option is disabled.

**Table 48. System setup options—System Logs menu**

<b>System Logs</b>	
<b>BIOS Event Log</b>	
Clear BIOS Event Log	Display BIOS events.

Table 48. System setup options—System Logs menu (continued)

System Logs
By default, the <b>Keep Log</b> option is enabled.

## Updating the BIOS

### Updating the BIOS in Windows

#### About this task

**CAUTION:** If BitLocker is not suspended before updating the BIOS, the next time you reboot the computer it will not recognize the BitLocker key. You will then be prompted to enter the recovery key to progress, and the computer will ask for this on each reboot. If the recovery key is not known this can result in data loss or an unnecessary operating system reinstall. For more information about this subject, search in the Knowledge Base Resource at [Dell Support Site](#).

#### Steps

1. Go to [Dell Support Site](#).
2. Click **Product support**. In the **Search support** box, enter the Service Tag of your computer, and then click **Search**.  
**NOTE:** If you do not have the Service Tag, use the SupportAssist to automatically identify your computer. You can also use the product ID or manually browse for your computer model.
3. Click **Drivers & Downloads**. Expand **Find drivers**.
4. Select the operating system installed on your computer.
5. In the **Category** drop-down list, select **BIOS**.
6. Select the latest version of BIOS, and click **Download** to download the BIOS file for your computer.
7. After the download is complete, browse the folder where you saved the BIOS update file.
8. Double-click the BIOS update file icon and follow the on-screen instructions.  
For more information, search in the Knowledge Base Resource at [Dell Support Site](#).

### Updating the BIOS in Linux and Ubuntu

To update the system BIOS on a computer that is installed with Linux or Ubuntu, see the knowledge base article [000131486](#) at [Dell Support Site](#).

### Updating the BIOS using the USB drive in Windows

#### About this task

**CAUTION:** If BitLocker is not suspended before updating the BIOS, the next time you reboot the computer it will not recognize the BitLocker key. You will then be prompted to enter the recovery key to progress, and the computer will ask for this on each reboot. If the recovery key is not known this can result in data loss or an unnecessary operating system reinstall. For more information about this subject, search in the Knowledge Base Resource at [Dell Support Site](#).

#### Steps

1. Follow the procedure from step 1 to step 6 in [Updating the BIOS in Windows](#) to download the latest BIOS setup program file.
2. Create a bootable USB drive. For more information, search in the Knowledge Base Resource at [Dell Support Site](#).
3. Copy the BIOS setup program file to the bootable USB drive.
4. Connect the bootable USB drive to the computer that needs the BIOS update.

5. Restart the computer and press **F12** .
6. Select the USB drive from the **One Time Boot Menu**.
7. Type the BIOS setup program filename and press **Enter**.  
The **BIOS Update Utility** appears.
8. Follow the on-screen instructions to complete the BIOS update.

## Updating the BIOS from the One-Time boot menu

Update your computer BIOS using the BIOS XXXX.exe file that is copied to a FAT32 USB drive and booting from the One-Time boot menu.

### About this task

**CAUTION:** If BitLocker is not suspended before updating the BIOS, the next time you reboot the computer it will not recognize the BitLocker key. You will then be prompted to enter the recovery key to progress, and the computer will ask for this on each reboot. If the recovery key is not known this can result in data loss or an unnecessary operating system reinstall. For more information about this subject, search in the Knowledge Base Resource at [Dell Support Site](#).

### BIOS Update

You can run the BIOS flash update file from Windows using a bootable USB drive or you can also update the BIOS from the One-Time boot menu on the computer.

You can confirm by booting your computer to the **One Time Boot** Menu to see if BIOS FLASH UPDATE is listed as a boot option . If the option is listed, then the BIOS can be updated using this method..

### Updating from the One-Time boot menu

To update your BIOS from the One-Time boot menu, you need the following:

- USB drive formatted to the FAT32 file system (the drive does not have to be bootable)
- BIOS executable file that you downloaded from the Dell Support website and copied to the root of the USB drive
- AC power adapter must be connected to the computer
- Functional computer battery to flash the BIOS

Perform the following steps to perform the BIOS flash update process from the One-Time boot menu:

**CAUTION:** Do not turn off the computer during the BIOS flash update process. The computer may not boot if you turn off your computer.

### Steps

1. Turn off your computer, insert the USB drive where you copied the BIOS flash update file into a USB port of the computer.
2. Turn on the computer and press to access the **One Time Boot** Menu. Select BIOS Update using the mouse or arrow keys then press Enter.  
The flash BIOS menu is displayed.
3. Click **Flash from file**.
4. Select the external USB device.
5. Select the file and double-click the flash target file, and then click **Submit**.
6. Click **Update BIOS**. The computer restarts to flash the BIOS.
7. The computer will restart after the BIOS flash update is completed.

## System and setup password

**Table 49. System and setup password**

Password type	Description
System password	Password that you must enter to log in to your system.



**Table 49. System and setup password (continued)**

Password type	Description
Setup password	Password that you must enter to access and make changes to the BIOS settings of your computer.

You can create a system password and a setup password to secure your computer.

 **CAUTION:** The password features provide a basic level of security for the data on your computer.

 **CAUTION:** Anyone can access the data that is stored on your computer, when left unattended.

 **NOTE:** System and setup password feature is disabled.

## Assigning a System Setup password

### Prerequisites

You can assign a new System or Admin Password only when the status is in **Not Set**.

### About this task

To enter BIOS System Setup, press F2 immediately after a power-on or reboot.

### Steps

1. In the **System BIOS** or **System Setup** screen, select **Security** and press Enter.  
The **Security** screen is displayed.
2. Select **System/Admin Password** and create a password in the **Enter the new password** field.  
Use the following guidelines to assign the system password:
  - A password can have up to 32 characters.
  - At least one special character: "( ! " # \$ % & ' \* + , - . / : ; < = > ? @ [ \ ] ^ \_ ` { | } )"
  - Numbers 0 to 9.
  - Upper case letters from A to Z.
  - Lower case letters from a to z.
3. **Confirm new password** type the system password that you entered earlier in the field and click **OK**.
4. Press Esc and save the changes as prompted by the message.
5. Press Y to save the changes.  
The computer restarts.

## Deleting or changing an existing system password or setup password

### Prerequisites

Ensure that the **Password Status** is Unlocked (in the System Setup) before attempting to delete or change the existing system password and/or setup password. You cannot delete or change an existing system password or setup password if the **Password Status** is Locked.

### About this task

To enter the System Setup, press F2 immediately after a power-on or reboot.

### Steps

1. In the **System BIOS** or **System Setup** screen, select **System Security** and press Enter.  
The **System Security** screen is displayed.
2. In the **System Security** screen, verify that the **Password Status** is Unlocked.

3. Select **System Password**. Update or delete the existing system password, and press Enter or Tab.
4. Select **Setup Password**. Update or delete the existing setup password, and press Enter or Tab.
  -  **NOTE:** If you change the system password and/or setup password, reenter the new password when prompted. If you delete the system password and/or setup password, confirm the deletion when prompted.
5. Press Esc. A message prompts you to save the changes.
6. Press Y to save the changes and exit from **System Setup**.  
The computer restarts.

## Clearing CMOS settings

### About this task

 **CAUTION:** Clearing CMOS settings reset the BIOS settings on your computer.

### Steps

1. Remove the [side cover](#).
2. Remove the [riser cover](#).
3. Remove the [coin-cell battery](#).
4. Wait for one minute.
5. Replace the [coin-cell battery](#).
6. Replace the [riser cover](#).
7. Replace the [side cover](#).

## Clearing BIOS (System Setup) and System passwords

### About this task

To clear the computer or BIOS passwords, contact Dell technical support as described at [Contact Support](#). For more information, go to [Dell Support Site](#).

 **NOTE:** For information about how to reset Windows or application passwords, see the documentation accompanying Windows or your application.

# Troubleshooting

## Dell SupportAssist Pre-boot System Performance Check diagnostics

### About this task

SupportAssist diagnostics (also known as system diagnostics) performs a complete check of your hardware. The Dell SupportAssist Pre-boot System Performance Check diagnostics is embedded with the BIOS and launched by the BIOS internally. The embedded system diagnostics provides options for particular devices or device groups allowing you to:

- Run tests automatically or in an interactive mode.
- Repeat the tests.
- Display or save test results.
- Run thorough tests to introduce additional test options to provide extra information about one or more failed devices.
- View status messages that inform you the tests are completed successfully.
- View error messages that inform you of problems encountered during testing.

 **NOTE:** Some tests for specific devices require user interaction. Always ensure that you are present at the computer when the diagnostic tests are performed.

For more information, see the knowledge base article [000180971](#).

## Running the SupportAssist Pre-Boot System Performance Check

### Steps

1. Turn on your computer.
2. As the computer boots, press the F12 key as the Dell logo appears.
3. On the boot menu screen, select the **Diagnostics** option.
4. Click the arrow at the bottom left corner.  
Diagnostics page is displayed.
5. Click the arrow in the lower-right corner to go to the page listing.  
The items that are detected are listed.
6. To run a diagnostic test on a specific device, press Esc and click **Yes** to stop the diagnostic test.
7. Select the device from the left pane and click **Run Tests**.
8. If there are any issues, error codes are displayed.  
Note the error code and validation number and contact Dell.

## Power-Supply Unit Built-in Self-Test

Built-in Self-Test (BIST) helps determine if the power-supply unit is working. To run self-test diagnostics on the power-supply unit of a desktop or all-in-one computer, search in the Knowledge Base Resource at [Dell Support Site](#).

# System-diagnostic lights

This section lists the system-diagnostic lights of your Precision 3280 CFF.

**Table 50. System-diagnostic lights**

Blinking pattern		Problem description	Suggested resolution
Amber	White		
1	2	Unrecoverable SPI Flash Failure	Replace the system board.
2	1	CPU failure	<ul style="list-style-type: none"> <li>Run the Dell Support Assist/Dell Diagnostics tool.</li> <li>If problem persists, replace the system board.</li> </ul>
2	2	System board failure (included BIOS corruption or ROM error)	<ul style="list-style-type: none"> <li>Flash latest BIOS version</li> <li>If problem persists, replace the system board.</li> </ul>
2	3	No memory/RAM detected	<ul style="list-style-type: none"> <li>Confirm that the memory module is installed properly.</li> <li>If problem persists, replace the memory module.</li> </ul>
2	4	Memory/RAM failure	<ul style="list-style-type: none"> <li>Reset and swap memory modules among the slots.</li> <li>If problem persists, replace the memory module.</li> </ul>
2	5	Invalid memory installed	<ul style="list-style-type: none"> <li>Reset and swap memory modules among the slots.</li> <li>If problem persists, replace the memory module.</li> </ul>
2	6	System board/Chipset Error	Replace the system board.
3	1	CMOS battery failure	<ul style="list-style-type: none"> <li>Reset the main battery connection.</li> <li>If problem persists, replace the main battery.</li> </ul>
3	2	PCI or Video card/chip failure	Replace the system board.
3	3	BIOS Recovery image not found	<ul style="list-style-type: none"> <li>Flash latest BIOS version</li> <li>If problem persists, replace the system board.</li> </ul>
3	4	BIOS Recovery image found but invalid	<ul style="list-style-type: none"> <li>Flash latest BIOS version</li> <li>If problem persists, replace the system board.</li> </ul>
3	5	Power rail failure	<ul style="list-style-type: none"> <li>EC ran into power sequencing failure.</li> <li>If problem persists, replace the system board.</li> </ul>
3	6	Flash corruption detected by SBIOS.	<ul style="list-style-type: none"> <li>Press power button for over 25 seconds to do</li> </ul>

**Table 50. System-diagnostic lights (continued)**

Blinking pattern		Problem description	Suggested resolution
Amber	White		
			<p>RTC reset. If problem persists, replace the system board.</p> <ul style="list-style-type: none"> <li>• Disconnect all power source (AC, battery, coin cell) and drain flea power by pressing and holding down power button 3~5 seconds to ensure all power are drained.</li> <li>• Run "BIOS recovery from USB", and the instructions are in the website <a href="#">Dell support</a>.</li> <li>• If problem persists, replace the system board.</li> </ul>
3	7	Timeout waiting on ME to reply to HECI message.	<ul style="list-style-type: none"> <li>• Timeout waiting on ME to reply to HECI message</li> <li>• If problem persists, replace the system board.</li> </ul>
4	2	CPU Power Cable Connection Issue	

## Recovering the operating system

When your computer is unable to boot to the operating system even after repeated attempts, it automatically starts Dell SupportAssist OS Recovery.

Dell SupportAssist OS Recovery is a stand-alone tool that is preinstalled in Dell computers running Windows operating system. It consists of tools to diagnose and troubleshoot issues that may occur before your computer boots to the operating system. It enables you to diagnose hardware issues, repair your computer, back up your files, or restore your computer to its factory state.

You can also download it from the Dell Support website to troubleshoot and fix your computer when it fails to boot into the primary operating system due to software or hardware failures.

For more information about the Dell SupportAssist OS Recovery, see *Dell SupportAssist OS Recovery User's Guide* at [Serviceability Tools at the Dell Support Site](#). Click **SupportAssist** and then, click **SupportAssist OS Recovery**.

## Real Time Clock—RTC reset

The Real Time Clock (RTC) reset function allows you or the service technician to recover the recently launched model Dell Latitude and Precision systems from **No POST/No Boot/No Power** situations. You can initiate the RTC reset on the system from a power-off state only if it is connected to AC power. Press and hold the power button for 25 seconds. The system RTC reset occurs after you release the power button.

**NOTE:** If AC power is disconnected from the system during the process or the power button is held longer than 40 seconds, the RTC reset process gets aborted.

The RTC reset will reset the BIOS to Defaults, un-provision Intel vPro and reset the system date and time. The following items are unaffected by the RTC reset:

- Service Tag
- Asset Tag
- Ownership Tag
- Admin Password
- System Password



- HDD Password
- Key Databases
- System Logs

 **NOTE:** The IT administrator's vPro account and password on the system will be un-provisioned. The system needs to go through the setup and configuration process again to reconnect it to the vPro server.

The below items may or may not reset based on your custom BIOS setting selections:

- Boot List
- Enable Legacy Option ROMs
- Secure Boot Enable
- Allow BIOS Downgrade

## Backup media and recovery options

It is recommended to create a recovery drive to troubleshoot and fix problems that may occur with Windows. Dell provides multiple options for recovering the Windows operating system on your Dell computer. For more information, see [Dell Windows Backup Media and Recovery Options](#).

## Wi-Fi power cycle

### About this task

If your computer is unable to access the Internet due to Wi-Fi connectivity issues, reset your Wi-Fi device by performing the following steps:

### Steps

1. Turn off the computer.
2. Turn off the modem.

 **NOTE:** Some Internet service providers (ISPs) provide a modem and router combo device.

3. Turn off the wireless router.
4. Wait for 30 seconds.
5. Turn on the wireless router.
6. Turn on the modem.
7. Turn on the computer.

# Getting help and contacting Dell

## Self-help resources

You can get information and help on Dell products and services using these self-help resources:

**Table 51. Self-help resources**

Self-help resources	Resource location
Information about Dell products and services	<a href="#">Dell Site</a>
Tips	
Contact Support	In Windows search, type <code>Contact Support</code> , and press Enter.
Online help for operating system	<a href="#">Windows Support Site</a> <a href="#">Linux Support Site</a>
Access top solutions, diagnostics, drivers and downloads, and learn more about your computer through videos, manuals, and documents.	Your Dell computer is uniquely identified using a Service Tag or Express Service Code. To view relevant support resources for your Dell computer, enter the Service Tag or Express Service Code at <a href="#">Dell Support Site</a> .  For more information about how to find the Service Tag for your computer, see <a href="#">Locate the Service Tag on your computer</a> .
Dell knowledge base articles	<ol style="list-style-type: none"> <li>1. Go to <a href="#">Dell Support Site</a>.</li> <li>2. On the menu bar at the top of the Support page, select <b>Support &gt; Support Library</b>.</li> <li>3. In the Search field on the Support Library page, type the keyword, topic, or model number, and then click or tap the search icon to view the related articles.</li> </ol>

## Contacting Dell

To contact Dell for sales, technical support, or customer service issues, see [Dell Support Site](#).

 **NOTE:** Availability of the services may vary depending on the country or region, and product.

 **NOTE:** If you do not have an active Internet connection, you can find contact information about your purchase invoice, packing slip, bill, or Dell product catalog.