

# Vigor2765/2766 Series

# VDSL2/G.Fast Security Router

## Quick Start Guide

(Wireless models)

Guide Version: **1.3**

Region: United Kingdom & Ireland

For updates and support, visit [www.draytek.co.uk](http://www.draytek.co.uk)

**August 2021 / Firmware V4.2.3\_BT**

**Note: Product specification is subject to continuous evolution which may not always be reflected in current documentation. For the formal specification and details of the supported features of your product, please refer only to the web site at [www.draytek.co.uk](http://www.draytek.co.uk)**

### Regional and Network Compatibility

For all models, please check that you have been supplied with a device intended for your geographic region and networks. Hardware and software varies by region, as well as local support and warranty services. To be sure of compatibility and local support, ensure that you are buying the correct product through authorized channels. The outside of the product's box will state the region compatibility (e.g. "Applied Region: UK"). If you are unsure, check with DrayTek or your supplier. The use of unofficial components (e.g. PSUs) or adapting interfaces or the use of unauthorized software/firmware may cause malfunction, product damage or personal danger and invalidates your warranty and access to support services.

## Safety and Warranty Information

### Safety Instructions

- Read the installation guide thoroughly before you set up the router.
- The router is a complicated electronic unit that may be repaired only be authorized and qualified personnel. Do not try to open or repair the router yourself.
- Do not place the router in a damp or humid place, e.g. a bathroom.
- Do not stack the routers.
- The router should be used in a sheltered area, within a temperature range of 0 to +40 Celsius.
- Do not expose the router to direct sunlight or other heat sources. The housing and electronic components may be damaged by direct sunlight or heat sources.
- Do not deploy the cable for LAN connection outdoor to prevent electronic shock hazards.
- Keep the package out of reach of children.
- When you want to dispose of the router, please follow local regulations on conservation of the environment.

### Warranty

We warrant to the original end user (purchaser) that the router will be free from any defects in workmanship or materials for a period of two (2) years from the date of purchase from a DrayTek authorized dealer in the UK/Ireland. Please keep your purchase receipt in a safe place as it serves as proof of date of purchase. During the warranty period, and upon proof of purchase, should the product have indications of failure due to faulty workmanship and/or materials, we will, at our discretion, repair or replace the defective products or components, without charge for either parts or labour, to whatever extent we deem necessary to restore the product to proper operating condition. Any replacement will consist of a new or re-manufactured functionally equivalent product of equal value, and will be offered solely at our discretion. This warranty will not apply if the product is modified, misused, tampered with, damaged by external factors, used with unapproved accessories or subjected to abnormal working conditions. Warranty applies to hardware only, not software or firmware. Defects which do not significantly affect the usability of the product will not be covered by the warranty. We reserve the right to revise the manual and online documentation and to make changes from time to time in the contents hereof without obligation to notify any person of such revision or changes.

## External Power Supply (Power Adapter) Information

	1	2	3	4	5	6	7	8	9
A Manufacturer	CWT	CWT	CWT	CWT	CWT	APD	APD	APD	APD
B Address	No. 222, Sec. 2, Nankan Rd., Lujhu Township, Taoyuan County 338, Taiwan	No. 222, Sec. 2, Nankan Rd., Lujhu Township, Taoyuan County 338, Taiwan	No. 222, Sec. 2, Nankan Rd., Lujhu Township, Taoyuan County 338, Taiwan	No. 222, Sec. 2, Nankan Rd., Lujhu Township, Taoyuan County 338, Taiwan	No. 222, Sec. 2, Nankan Rd., Lujhu Township, Taoyuan County 338, Taiwan	No. 5, Lane 83, Lung-Sou St., Taoyuan City 330, Taiwan	No. 5, Lane 83, Lung-Sou St., Taoyuan City 330, Taiwan	No. 5, Lane 83, Lung-Sou St., Taoyuan City 330, Taiwan	No. 5, Lane 83, Lung-Sou St., Taoyuan City 330, Taiwan
C Model identifier	2ABB012F UK 2ABB012F EU	2ABB018F UK 2ABB018F EU	2ABL024F UK 2ABL024F EU	2ABL030F UK 2ABL030F EU	2ABN036F UK 2ABN036F EU	WA-12M12FG WA-12M12FK	WB-18D12FG WB-18D12FK	WA-24Q12FG WA-24Q12FK	WA-36A12FG WA-36A12FK
D Input voltage	100-240V	100-240V	100-240V	100-240V	100-240V	100-240V	100-240V	100-240V	100-240V
E Input AC frequency	50/60Hz	50/60Hz	50/60Hz	50/60Hz	50/60Hz	50/60Hz	50/60Hz	50/60Hz	50/60Hz
Output voltage DC	12.0V	12.0V	12.0V	12.0V	12.0V	12.0V	12.0V	12.0V	12.0V
F Output current	1.0A	1.5A	2.0A	2.5A	3.0A	1.0A	1.5A	2.0A	3.0A
G Output power	12.0W	18.0W	24.0W	30.0W	36.0W	12.0W	18.0W	24.0W	36.0W
H Average active efficiency	84.9%	86.2%	87.6%	87.8%	89.8%	83.7%	85.4%	88.6%	88.2%
I Efficiency at low load 10%	73.6%	78.0%	81.3%	83.3%	83.7%	74.5%	80.5%	86.4%	85.4%
J No-load power consumption	0.07W	0.07W	0.07W	0.07W	0.07W	0.07W	0.10W	0.07W	0.10W

For more updates & information, please visit [www.draytek.co.uk](http://www.draytek.co.uk). The external power supply used for each product will be model dependent.



### Join the UK mailing list

Users in the UK & Ireland can sign up to our mailing list which goes out approximately 4 times per year with products news, updates, hints & tips and offers. For details, please visit [www.draytek.co.uk/list](http://www.draytek.co.uk/list)

### Firmware & Tools Updates

Due to the continuous evolution of DrayTek technology and emerging risks, router firmware updates may be issued. Please consult the DrayTek web site for more information on newest firmware, tools and documents: [www.draytek.co.uk](http://www.draytek.co.uk) (For UK/Ireland)



## Declaration of Conformity

Hereby, DrayTek Corporation declares that the radio equipment type Vigor2765 is in compliance with Regulation SI 2017 No. 1206.

The full text of the UKCA Declaration of Conformity is available at the following internet address:

<https://www.draytek.com.tw/ftp/Vigor2765/Document/UKCA/>

<https://www.draytek.com.tw/ftp/Vigor2766/Document/UKCA/>

Manufacturer: DrayTek Corp.

Address: No. 26, Fushing Rd., Hukou, Hsinchu Industrial Park, Hsinchu 303, Taiwan

Product: Vigor2765/2766 Wireless Series

Importer: SEG, 11 Capital Business Park, Borehamwood, Herts, WD6 1GW

Frequency Information for UK area:

2.4G WLAN	2412MHz - 2472 MHz, max. TX power: 19.79dBm *1
5G WLAN	5160MHz - 5340 MHz, max. TX power: 22.74dBm *2 5480MHz - 5720 MHz, max. TX power: 29.88dBm
	Requirements in UK. 5150MHz~5350MHz is for indoor use only.

(\*1: for 2.4G WLAN model; \*2: for 5G WLAN model)

This product is designed for DSL and 2.4GHz /5GHz WLAN network use in the UK & Ireland.



## Declaration of Conformity

Hereby, DrayTek Corporation declares that the radio equipment type Vigor2765 is in compliance with Directive 2014/53/EU.

The full text of the EU declaration of conformity is available at the following internet address:

<http://www.draytek.com.tw/ftp/Vigor2765/Document/CE/>

<http://www.draytek.com.tw/ftp/Vigor2766/Document/CE/>

Manufacturer: DrayTek Corp.

Address: No. 26, Fushing Rd., Hukou, Hsinchu Industrial Park, Hsinchu 303, Taiwan

Product: Vigor2765/2766 Wireless Series

Importer: SEG, 11 Capital Business Park, Borehamwood, Herts, WD6 1GW

Frequency Information for Europe area:

2.4G WLAN	2412MHz - 2472 MHz, max. TX power: 19.79dBm *1
5G WLAN	5160MHz - 5340 MHz, max. TX power: 22.74dBm *2 5480MHz - 5720 MHz, max. TX power: 29.88dBm
	Requirements in AT/BE/BG/CZ/DZ/DK/EE/FR/DE/IS/IE/IT/EL/ES/ CY/LV/LI/LT/LU/HU/MT/NL/NO/PL/PT/RO/SI/SK/TR/FI/SE/CH/ HR. 5150MHz~5350MHz is for indoor use only.

(\*1: for 2.4G WLAN model; \*2: for 5G WLAN model)

This product is designed for DSL and 2.4GHz / 5GHz WLAN network **throughout the EC region.**

## **Table of Contents**

<b>1. Package Contents.....</b>	<b>1</b>
<b>2. Panel Explanation.....</b>	<b>2</b>
2.1 Vigor2765ac/Vigor2766ac.....	2
2.2 Vigor2765Vac/Vigor2766Vac.....	4
<b>3. Hardware Installation .....</b>	<b>6</b>
3.1 Connecting up the Vigor Router.....	6
3.2 Wall-Mounting the Vigor 2765 .....	7
<b>4. Setup &amp; Configuration.....</b>	<b>8</b>
4.1 Accessing the Router Web Interface.....	8
4.2 WAN1 – ADSL & VDSL Connection Setup .....	11
4.2.1 PPPoE connection with FTTC VDSL2 .....	11
4.2.2 DHCP / Static IP connection with FTTC VDSL2 .....	14
4.2.3 PPPoA connection with ADSL / ADSL2+.....	17
4.3 WAN2 – Ethernet Connection Setup.....	18
4.3.1 Enabling the Ethernet WAN Port .....	19
4.3.2 PPPoE.....	20
4.3.3 Static or Dynamic IP.....	21
4.4 WAN3 / WAN4 – 3G / 4G USB Modem Setup .....	23
4.4.1 PPP Mode .....	23
4.4.2 DHCP Mode .....	25
<b>5. Getting Further Help.....</b>	<b>26</b>
5.1 Additional Feature Setup.....	26
5.2 Keep up to date with our mailing list .....	26
5.3 Firmware Updates .....	27
5.4 Security & Router Best Practice.....	27

# 1. Package Contents



**DrayTek Vigor router**

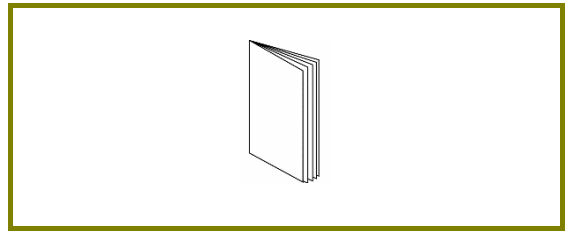

**Quick Start Guide**  
(This document)

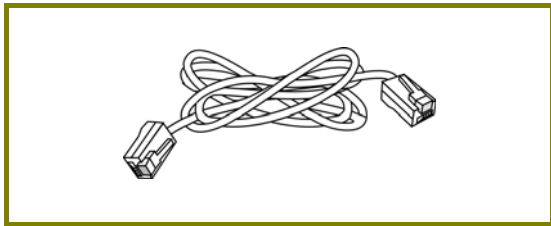

**RJ-45 Cable (Ethernet)**  
(Connects to your PC or Switch)

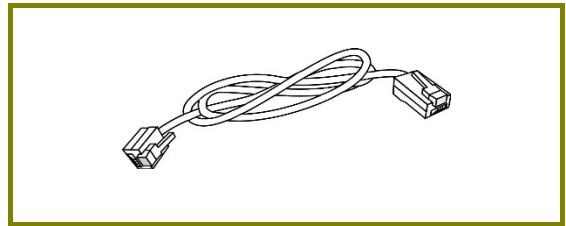

**RJ-11 to RJ-11 Cable**  
(Connects to your DSL line)

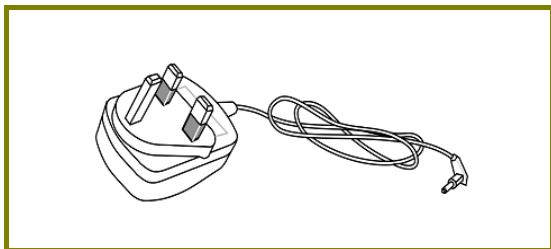

**UK Power Adapter**

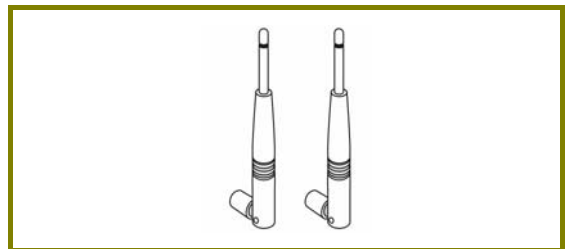

**Antenna**

The maximum power consumption is *17-23 Watts*.



---

**Important  
Note**

---





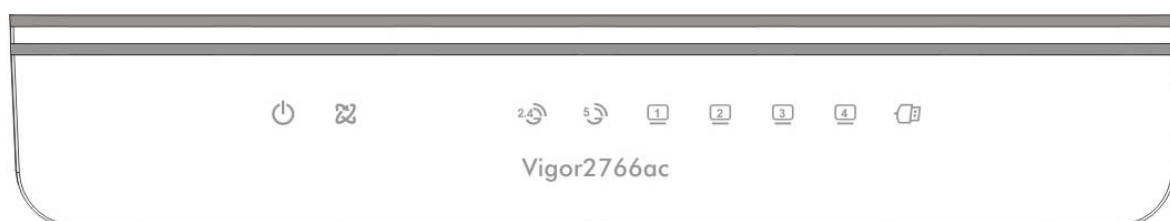
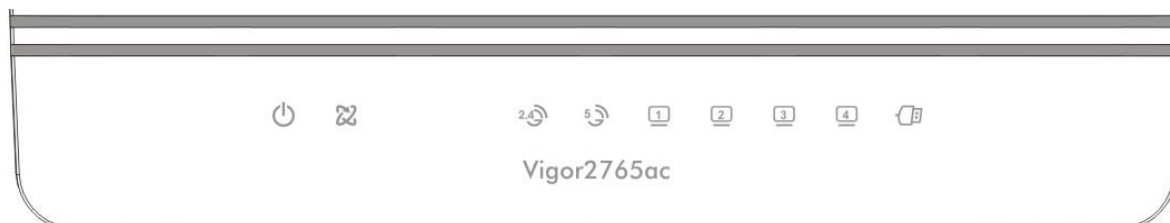

Remove the protective film from the router before use to ensure ventilation.

---

## 2. Panel Explanation

### 2.1 Vigor2765ac/Vigor2766ac





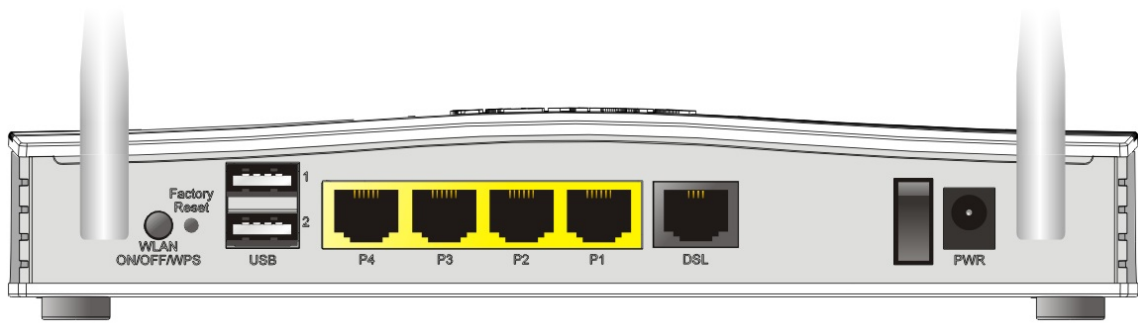





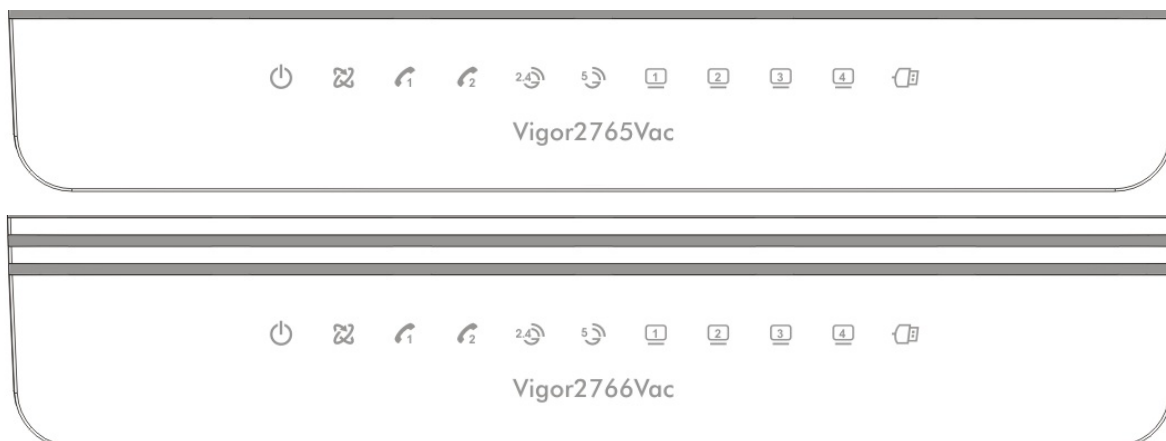

LED	Status	Explanation
 (Activity)	Blinking	The router is ready and operating normally
	Off	The router is powered off
 (DSL)	On	DSL connection synchronised
	Blinking (Slowly)	DSL connection not currently synchronizing or not detected
	Blinking (Quickly)	DSL connection is synchronising
 (Wireless LAN On/Off/WPS)	On (Green)	2.4GHz Access Point is active
	Blinking (Green)	Data is being transmitted on the router's 2.4 GHz wireless interface
	Blinking (Orange)	WPS pairing mode is active for two minutes
	Off	2.4GHz Access Point is turned off
 (Wireless LAN On/Off/WPS)	On (Green)	5GHz Access Point is active
	Blinking (Green)	Data is being transmitted on the router's 5GHz wireless interface
	Blinking (Orange)	WPS pairing mode is active for two minutes
 (LAN1/2/3/4)	On	Ethernet LAN (RJ45) is connected
	Blinking	Data is transmitting (sending/receiving)
	Off	Ethernet LAN is disconnected
 (USB)	On	USB device is connected and ready for use
	Blinking	Data is being transmitted over USB



Interface	Description
WLAN ON/OFF/WPS	<p>Press for less than 2 seconds to switch toggle the router's wireless interfaces:</p> <p>For example,</p> <ul style="list-style-type: none"> <li>● 2.4G (On) and 5G (On) - Default state.</li> <li>● 2.4G (Off) and 5G (On) - press and release the button once.</li> <li>● 2.4G (On) and 5G (Off) - press and release the button twice.</li> <li>● 2.4G (Off) and 5G (Off) - press and release the button three times.</li> </ul> <p>When WPS is enabled in the router's web interface, press this button for more than 2 seconds to enable WPS pairing mode.</p>
Factory Reset	<p>Restore the default settings.</p> <p>Usage: Turn on the router (ACT LED is blinking). Press gently and hold for more than 5 seconds. When the ACT LED blinks rapidly, release the button. Then the router will restart with the factory default configuration</p>
USB1~USB2	Connector for a USB 3G/4G modem, storage, printer or USB Thermometer
P1~P4	<p>RJ-45 Gigabit Ethernet connectors for local network devices.</p> <p>LAN port P4 can be configured as the Ethernet WAN port, see Section 5.3 for details</p>
DSL	RJ-11 connector for ADSL or VDSL line
I/O	Power Switch. Turns the unit on (I) or off (O)
PWR	Connector for the power adapter

## 2.2 Vigor2765Vac/Vigor2766Vac



LED	Status	Explanation
 (Activity)	Blinking	The router is ready and operating normally
	Off	The router is powered off
 (DSL)	On	DSL connection synchronised
	Blinking (Slowly)	DSL connection not currently synchronising or not detected
	Blinking (Quickly)	DSL connection is synchronising
 	On	The phone connected to this port is off-hook
	Off	The phone connected to this port is on-hook
	Blinking	A phone call is incoming
 (Wireless LAN On/Off/WPS)	On (Green)	2.4GHz Access Point is active
	Blinking (Green)	Data is being transmitted on the router's 2.4 GHz wireless interface
	Blinking (Orange)	WPS pairing mode is active for two minutes
	Off	2.4GHz Access Point is turned off
 (Wireless LAN On/Off/WPS)	On (Green)	5GHz Access Point is active
	Blinking (Green)	Data is being transmitted on the router's 5GHz wireless interface
	Blinking (Orange)	WPS pairing mode is active for two minutes
	Off	5GHz Access Point is turned off
  (LAN1/2/3/4)	On	Ethernet LAN (RJ45) is connected
	Blinking	Data is transmitting (sending/receiving)
	Off	Ethernet LAN is disconnected
 (USB)	On	USB device is connected and ready for use
	Blinking	Data is being transmitted over USB



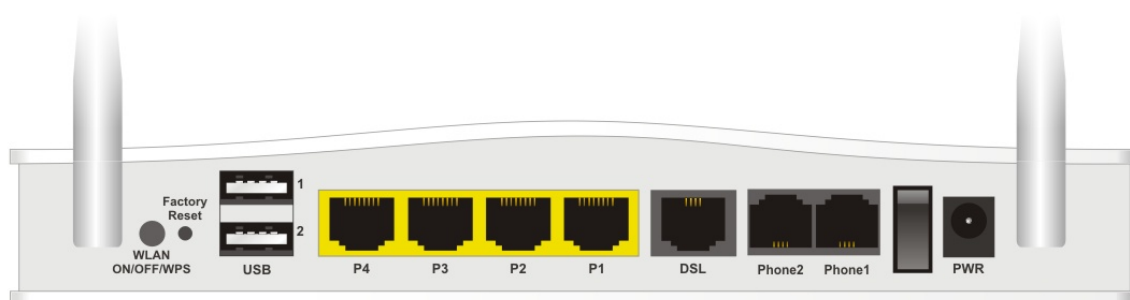

Interface	Description
WLAN ON/OFF/WPS	<p>Press for less than 2 seconds to switch toggle the router's wireless interfaces:</p> <p>For example,</p> <ul style="list-style-type: none"> <li>● 2.4G (On) and 5G (On) - Default state.</li> <li>● 2.4G (Off) and 5G (On) - press and release the button once.</li> <li>● 2.4G (On) and 5G (Off) - press and release the button twice.</li> <li>● 2.4G (Off) and 5G (Off) - press and release the button three times.</li> </ul> <p>When WPS is enabled in the router's web interface, press this button for more than 2 seconds to enable WPS pairing mode.</p>
Factory Reset	<p>Restore the default settings.</p> <p>Usage: Turn on the router (ACT LED is blinking). Press gently and hold for more than 5 seconds. When the ACT LED blinks rapidly, release the button. Then the router will restart with the factory default configuration</p>
USB1~USB2	Connector for a USB 3G/4G modem, storage, printer or USB Thermometer
P1~P4	<p>RJ-45 Gigabit Ethernet connectors for local network devices.</p> <p>LAN port P4 can be configured as the Ethernet WAN port, see Section 5.3 for details</p>
DSL	RJ-11 connector for ADSL or VDSL line
Phone2/Phone1	RJ-11 connectors for VoIP usage with analogue telephones
I/O	Power Switch. Turns the unit on (I) or off (O)
PWR	Connector for the power adapter

### 3. Hardware Installation

#### 3.1 Connecting up the Vigor Router

Here we take Vigor2765ac as an example.

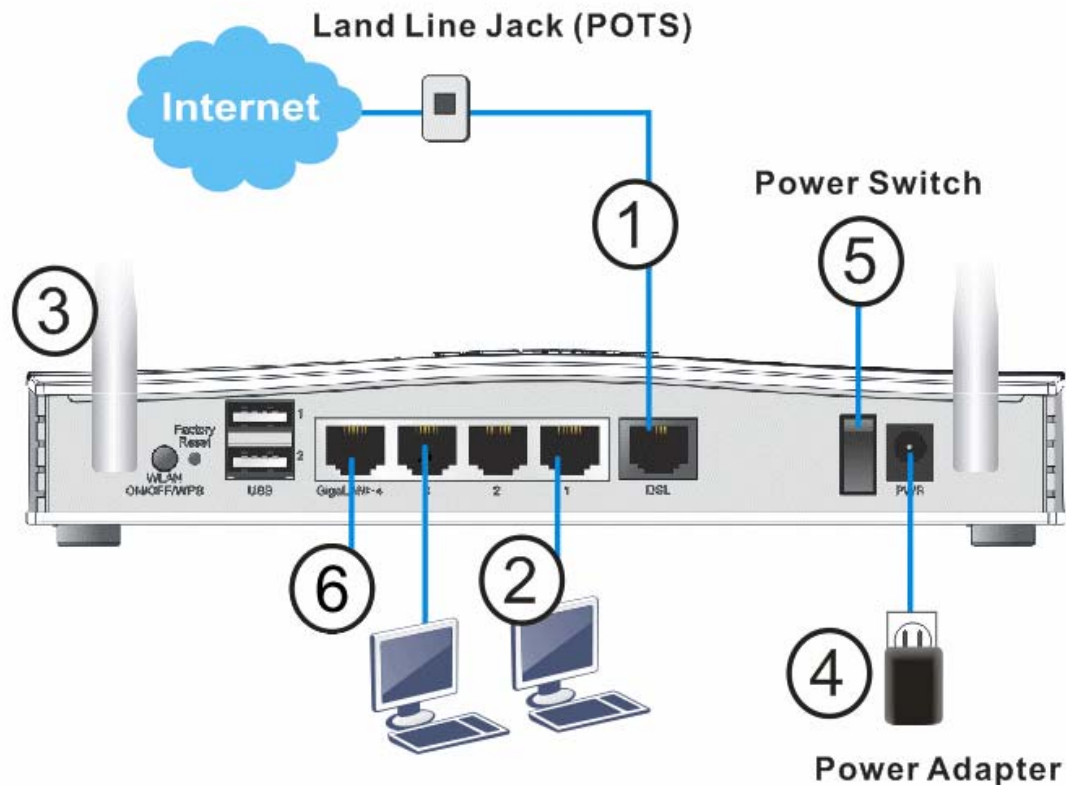

1. **ADSL/VDSL Connections:** Connect the DSL port to the Modem or DSL port of the external splitter/microfilter (not supplied) with the RJ-11 line cable. In some cases, your RJ-11 DSL socket will be built-into your phone line socket on the wall and you won't have a separate microfilter/splitter.
2. **LAN Connections:** Connect a LAN port of the router to your computer or switch.
3. **Wireless Antennas:** Connect the wireless antennas to the router
4. **Power Supply:** Connect the power adapter to the Vigor 2765's PWR socket on the rear and plug the power adapter into a suitable mains socket. Turn the Vigor 2765 on using its power switch.
5. The router will start up. After completing the system test, the ACT LED will light up and start blinking once per second to indicate that it is ready for use. For more detailed information of LED status, please refer to section 3.1 Front Panel Overview.
6. **Ethernet-based Internet Connections:** LAN port P4 can be switched to operate as the Ethernet WAN port. This must be configured in the router's web interface before it can operate in this mode - Section 5.3 of this Quick Start Guide details how to do that.

### 3.2 Wall-Mounting the Vigor Router

DrayTek Vigor 2765/2766 series routers have keyhole type mounting slots on the underside to hang the router on, using screws attached to a wall or other surface.

1. Drill two holes on the wall. The distance between the holes shall be 168mm.
2. Fit screws into the wall using the appropriate type of wall plug
3. With the screws installed, the router can be slotted into place

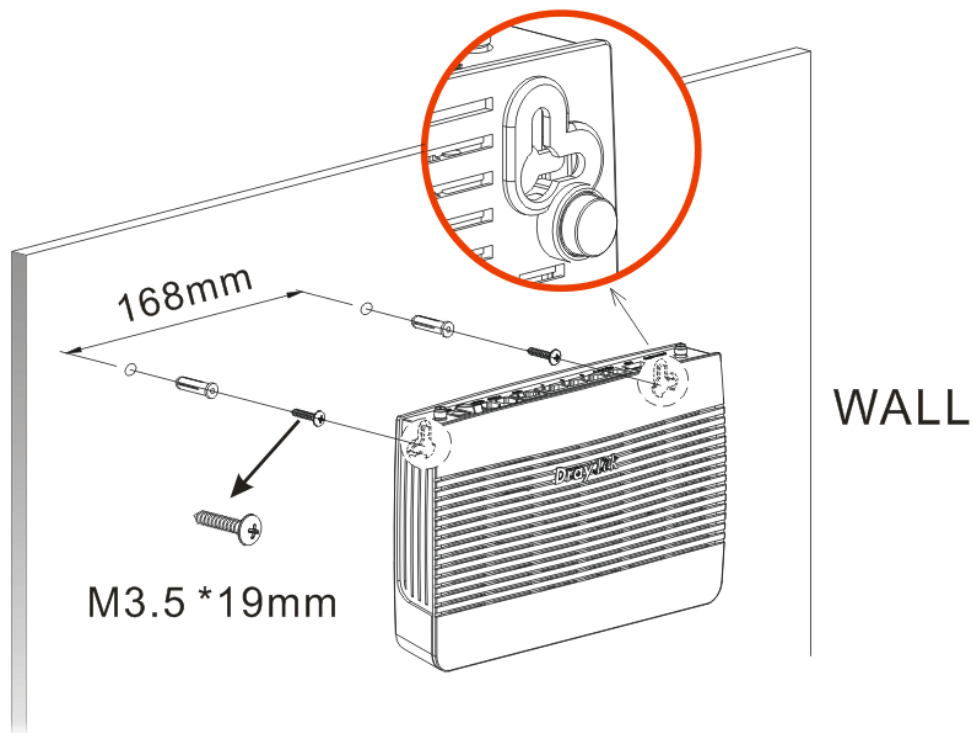

Note

The recommended drill diameter is 6.5mm (1/4").

## 4. Setup & Configuration

This section provides examples of how to initially access the router and configure internet access for the most common types of Internet connection in the UK.

If the instructions in this quick start guide do not allow you to get online with your ISP or type of Internet connection, there are additional guides available from the Product Knowledgebase on [www.draytek.co.uk](http://www.draytek.co.uk).



### Note

To access the router, your PC will need to either get its IP address using DHCP or have an IP address in the 192.168.1.x range.

For details on how to change this, please refer to the "Trouble Shooting" section in the User Guide.

### 4.1 Accessing the Router Web Interface

Open a web browser on your PC and type `https://192.168.1.1`.

The `https://` prefix ensures that your connection is encrypted using SSL so that your session data cannot be intercepted. Without that prefix, your data passes in clear text.

You may get a warning from your browser (IE, Chrome, Edge, Safari etc.) about your server (the router) having an invalid certificate. Your browser will demand further confirmation or exception before allowing access. The warnings will look something like these examples.

An example of how to access the router via HTTPS with Mozilla Firefox:

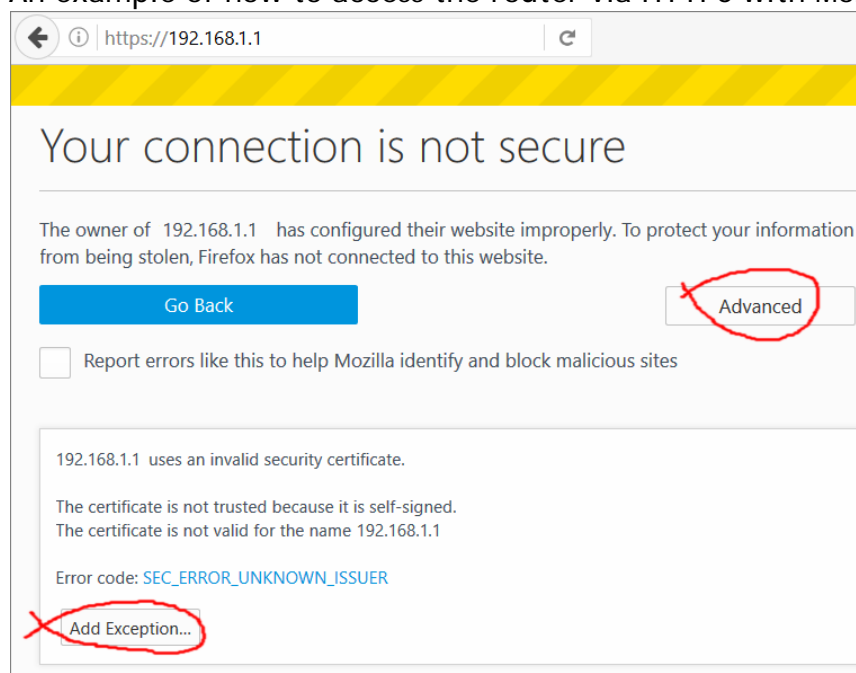

An example from Microsoft Edge, click "Continue to this webpage" to proceed:

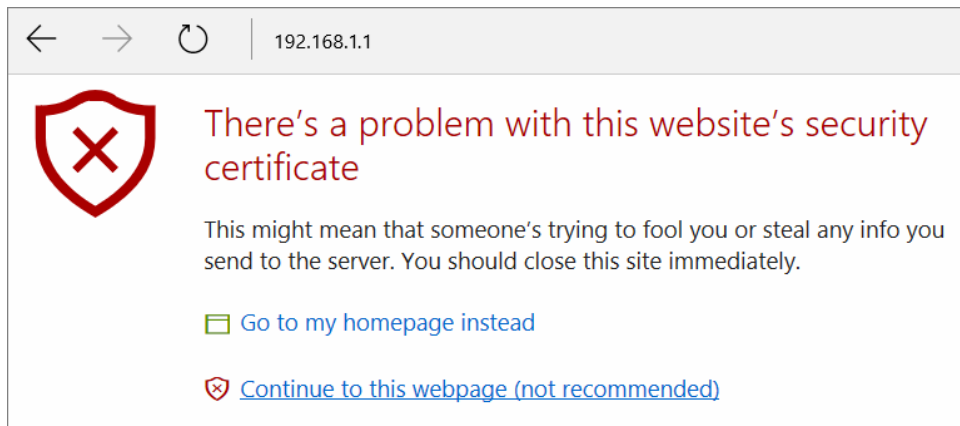

Most other browsers will present equivalent warnings. In each case, following the prompts/links will allow you to access the router's web interface. It is still encrypted with SSL/TLS.



---

**Note**

This warning appears because the router's default certificate is 'self-signed' rather than issued to you by a certificate authority who has verified your identity.

A self-signed certificate means that you cannot verify the identity of the server, but as it's your own local router, that shouldn't be an issue - your connection is still encrypted.

---

The router login prompt will then request a username and password to allow access. [Here we take Vigor2765 as an example.](#)



The factory default login details are:

Username: admin

Password: admin



### Note

If you cannot access the web interface, please go to the “Trouble Shooting” section in the User Guide to determine the cause of and solve your problem.

Upon successful login, the router will display the **Dashboard**, which shows a summary of the router model, WAN status, front panel port status and other information:

**System Information**

Model Name	Vigor2765ac	System Up Time	0:02:34
Router Name	DrayTek	Current Time	Sat Jan 01 2000 00:02:21
Firmware Version	r87406_beta	Build Date/Time	Dec 20 2019 14:33:40
DSL Version	08-08-00-0F-00-07	LAN MAC Address	00-1D-AA-40-D8-90

**IPv4 LAN Information**

	IP Address	DHCP		IP Address	DHCP
LAN1	192.168.1.1/24	v	LAN2	192.168.2.1/24	v
IP Routed Subnet	192.168.0.1/24	v			

**IPv4 Internet Access**

	Line / Mode	IP Address	MAC Address	Up Time
WAN1	VDSL2 / PPPoE	Disconnected	00-1D-AA-40-D8-91	00:00:00
WAN2	Ethernet / ---	Disconnected	00-1D-AA-40-D8-92	00:00:00
WAN3	USB / ---	Disconnected	00-1D-AA-40-D8-93	00:00:00

**Interface**

DSL	Connected : Down Stream : 0Kbps / Up Stream : 0Kbps
WAN	Connected : 0, WAN1 WAN2 WAN3
LAN	Connected : 0, Port1 Port2 Port3 Port4
WLAN	Connected : 0
WLAN5G	Connected : 0
USB	Connected : 0, USB 1, USB 2

**Quick Access**

- System Status
- Dynamic DNS
- TR-069
- IM/P2P Block
- Schedule
- SysLog / Mail Alert
- RADIUS
- Firewall Object Setting
- Data Flow Monitor



### Note

We recommend configuring a secure password when first logging in to the router’s administration interface.

The router’s administration password can be changed from [System Maintenance] > [Administrator Password]

## 4.2 WAN1 – ADSL & VDSL Connection Setup

The WAN1 interface of the Vigor 2765 router can connect to VDSL2 / 35b and ADSL2+ lines.

If your Internet connection uses VDSL2 and your ISP has supplied you with a Username and Password to connect to the Internet, go to section

### 4.2.1 PPPoE connection with FTTC VDSL2

If your Internet connection uses VDSL2 and your ISP does not supply or require a Username and Password to connect to the Internet, go to section

### 4.2.2 DHCP / Static IP connection with FTTC VDSL2

If your Internet connection uses ADSL or ADSL2+ and your ISP has supplied you with a Username and Password to connect to the Internet, go to section

### 4.2.3 PPPoA connection with ADSL / ADSL2+

### 4.2.1 PPPoE connection with FTTC VDSL2

1. Go to [WAN] > [General Setup] and click on the WAN1 link:

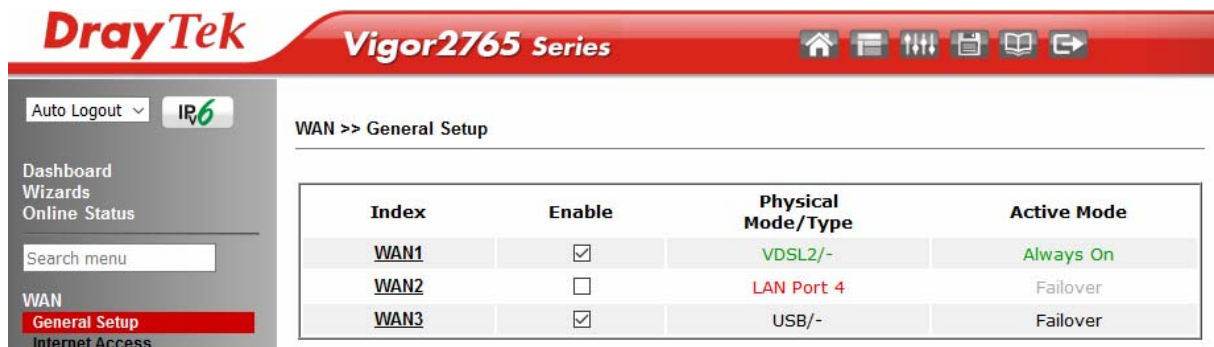

DrayTek Vigor2765 Series

WAN >> General Setup

Index	Enable	Physical Mode/Type	Active Mode
<u>WAN1</u>	<input checked="" type="checkbox"/>	VDSL2/-	Always On
<u>WAN2</u>	<input type="checkbox"/>	LAN Port 4	Failover
<u>WAN3</u>	<input checked="" type="checkbox"/>	USB/-	Failover

2. On the settings page:

- Set the Enable option to Yes to activate the WAN1 connection
- Set the Active Mode to Always On
- Enable the Service - VLAN Tag insertion
- Set the Tag value setting to 101
- DSL mode can be set to "VDSL2 only" but this is not required



#### Note

The VLAN tag value of 101 is required to connect to ISPs that operate on the Openreach VDSL2 network, if your ISP operates on a different VDSL2 network, this tag value may differ. Please check with your ISP or the DrayTek UK Knowledgebase for ISP specific guides.

WAN >> General Setup

**WAN 1**

Enable:	Yes ▾	
Display Name:	<input type="text"/>	
Physical Mode:	VDSL2	
DSL Mode:	Auto ▾	
DSL Modem Code:	AnnexA_779517_773F01 ▾	
Line Speed(Kbps):		
DownLink	<input type="text" value="0"/>	
UpLink	<input type="text" value="0"/>	
Active Mode:	Always On ▾	
VLAN Tag insertion	Customer	Service
<b>ADSL</b>	Disable ▾ Tag value Priority <input type="text" value="0"/> <input type="text" value="0"/> (0~4095) (0~7)	
<b>VDSL2</b>	Disable ▾ Tag value Priority <input type="text" value="0"/> <input type="text" value="0"/> (0~4095) (0~7)	Enable ▾ Tag value Priority <input type="text" value="101"/> <input type="text" value="0"/> (0~4095) (0~7)

Click OK on that page to apply the changes.

3. Go to [WAN] > [Internet Access]

Set the WAN1 Access Mode to PPPoE / PPPoA, then click the Details Page button to proceed:

WAN >> Internet Access

Index	Physical Mode	Access Mode	
WAN1	ADSL / VDSL2	PPPoE / PPPoA ▾	Details Page
WAN2	Ethernet	None ▾	Details Page
WAN3	USB	None ▾	Details Page

4. On the PPPoE / PPPoA settings tab:

Select the Enable radio button at the top of the page to ensure that the PPPoE interface is enabled.

In the ISP Access Setup section, input the ISP username into the Username field and password in the Password field.

If your ISP has provided a static IP address, that can be specified by setting the Fixed IP setting to Yes and entering the IP in the Fixed IP Address field.



WAN 1

PPPoE / PPPoA	MPoA / Static or Dynamic IP	IPv6
<input checked="" type="radio"/> Enable <input type="radio"/> Disable		
<b>ADSL Modem Settings</b> Multi-PVC channel: <input type="text" value="Channel 1"/> VPI: <input type="text" value="0"/> VCI: <input type="text" value="38"/> Encapsulating Type: <input type="text" value="VC MUX"/> Protocol: <input type="text" value="PPPoA"/> Modulation: <input type="text" value="Multimode"/>		
<b>ISP Access Setup</b> Username: <input type="text" value="23456@HG01.btclick.com"/> Password: <input type="password" value="....."/> More Options <input type="button" value="+"/>		
<b>PPP/MP Setup</b> PPP Authentication: <input type="text" value="PAP or CHAP"/> IP Assignment (IPCP): <input type="radio"/> Static <input checked="" type="radio"/> Dynamic Fixed IP Address: <input type="text"/> <input type="button" value="WAN IP Alias"/>		
<b>Dial-Out Schedule</b> Index(1-15) in <u>Schedule</u> Setup: None => None => None => None		
<b>PPPoE Pass-through</b> <input type="checkbox"/> For Wired LAN <sup>2</sup> <input type="checkbox"/> For Wireless LAN		

Click OK on this page to apply the changes and the router will then prompt to restart. Click the OK button to restart the router.

- Once the router has restarted, the [Online Status] > [Physical Connection] page will display the VDSL information and PPP connection status, if the WAN1 section shows an IP address, it has connected to the internet successfully:

Auto Logout IPv6

Dashboard  
Quick Start Wizard  
Online Status  
**Physical Connection**  
Virtual WAN

WAN  
LAN  
NAT  
Firewall  
User Management  
Objects Setting  
CSM  
Bandwidth Management  
Applications  
VPN and Remote Access  
Certificate Management  
Wireless LAN  
SSL VPN  
USB Application  
System Maintenance  
Diagnostics  
External Devices

Support Area  
Product Registration

Online Status

---

Physical Connection System Uptime: 0:8:44

IPv4		IPv6	
LAN Status			
IP Address	TX Packets	RX Packets	Primary DNS: 194.72.0.98
192.168.1.1	0	0	Secondary DNS: 213.120.234.26
WAN 1 Status <span style="float: right;">&gt;&gt; Drop PPPoA</span>			
Enable	Line	Name	Mode
Yes	VDSL2		PPPoE
IP	GW IP	TX Packets	TX Rate(Bps)
217.34.6.35	217.42.145.215	224580	805
		RX Packets	RX Rate(Bps)
		339568	963
WAN 2 Status			
Enable	Line	Name	Mode
Yes	Ethernet		---
IP	GW IP	TX Packets	TX Rate(Bps)
---	---	0	0
		RX Packets	RX Rate(Bps)
		0	0
WAN 3 Status			
Enable	Line	Name	Mode
Yes	USB		---
IP	GW IP	TX Packets	TX Rate(Bps)
---	---	0	0
		RX Packets	RX Rate(Bps)
		0	0
VDSL2 Information (VDSL2 Firmware Version: 8B0F07_A/B/C)			
Profile	State	UP Speed	Down Speed
17A	SHOWTIME	20000 (Kbps)	80000 (Kbps)
		SNR Upstream	SNR Downstream
		15 (0.1dB)	6 (0.1dB)



#### Note

If the WAN 1 IP address displayed begins with 172.16.x.x, it's possible that the ISP has not accepted the supplied Username and Password for the Internet connection.

Check that the ISP Access Setup - Username and Password match the details supplied by your ISP.

## 4.2.2 DHCP / Static IP connection with FTTC VDSL2

1. Go to [WAN] > [General Setup] and click on the WAN1 link:

DrayTek Vigor2765 Series

Auto Logout

Dashboard  
Wizards  
Online Status

Search menu

WAN  
General Setup  
Internet Access

WAN >> General Setup

Index	Enable	Physical Mode/Type	Active Mode
<a href="#">WAN1</a>	<input checked="" type="checkbox"/>	VDSL2/-	Always On
<a href="#">WAN2</a>	<input type="checkbox"/>	LAN Port 4	Failover
<a href="#">WAN3</a>	<input checked="" type="checkbox"/>	USB/-	Failover

2. On the settings page:

- Set the Enable option to Yes to activate the WAN1 connection
- Set the Active Mode to Always On
- Enable the Service - VLAN Tag insertion
- Set the Tag value setting to 101
- DSL mode can be set to "VDSL2 only" but this is not required



#### Note

The VLAN tag value of 101 is required to connect to ISPs that operate on the Openreach VDSL2 network, if your ISP operates on a different VDSL2 network, this tag value may differ. Please check with your ISP or the DrayTek UK Knowledgebase for ISP specific guides.

WAN >> General Setup

**WAN 1**

Enable:	Yes ▾	
Display Name:	<input type="text"/>	
Physical Mode:	VDSL2	
DSL Mode:	Auto ▾	
DSL Modem Code:	AnnexA_779517_773F01 ▾	
Line Speed(Kbps):		
DownLink	<input type="text" value="0"/>	
UpLink	<input type="text" value="0"/>	
Active Mode:	Always On ▾	

VLAN Tag insertion	Customer	Service
<b>ADSL</b>	Disable ▾ Tag value <input type="text" value="0"/> Priority <input type="text" value="0"/> (0~4095) (0~7)	
<b>VDSL2</b>	Disable ▾ Tag value <input type="text" value="0"/> Priority <input type="text" value="0"/> (0~4095) (0~7)	Enable ▾ Tag value <input type="text" value="101"/> Priority <input type="text" value="0"/> (0~4095) (0~7)

Click OK on that page to apply the changes.

3. Go to [WAN] > [Internet Access]

Set the WAN1 Access Mode to MPoA / Static or Dynamic IP, then click the Details Page button to proceed:

Auto Logout ▾

Dashboard  
Wizards  
Online Status

**WAN**

General Setup

**Internet Access**

Multi-PVC/VLAN

WAN Budget

LAN

WAN >> Internet Access

**Internet Access**

Index	Physical Mode	1 Access Mode	2
WAN1	ADSL / VDSL2	MPoA / Static or Dynamic IP ▾	Details Page
WAN2	Ethernet	None ▾	Details Page
WAN3	USB	None ▾	Details Page

4. In the MPoA / Static or Dynamic IP settings:

Select the Enable option and select Obtain an IP address automatically which will obtain an IP from the ISP using DHCP.

If your ISP has provided a static IP range, with a Network address and a Subnet Mask, specify that with the Specify an IP address option.

**WAN 1**

Enable    Disable

---

**ADSL Modem Settings**

Multi-PVC channel:

Encapsulation:

VPI:

VCI:

Modulation:

---

**IP Network Settings**

Obtain an IP address automatically  
 More Options

Specify an IP address  
 IP Address:   
 Subnet Mask:

---

**WAN Connection Detection**

Mode:

---

**MTU**

(Max:1500)  

---

**RIP Routing**

Enable RIP

---

**Bridge Mode**

Enable Bridge Mode  
 Enable Full Bridge Mode  
 Bridge Subnet:

---

**MAC Address**

Default MAC Address

Click OK on this page to apply the changes and the router will then prompt to restart. Click the OK button to restart the router.

- Once the router has restarted, the [Online Status] > [Physical Connection] page will display the VDSL information and DHCP connection status, if the WAN1 section shows an IP address, it has connected to the internet successfully:

Auto Logout

Dashboard

Quick Start Wizard

Online Status

Physical Connection

Virtual WAN

---

WAN

LAN

NAT

Firewall

User Management

Objects Setting

CSM

Bandwidth Management

Applications

VPN and Remote Access

Certificate Management

Wireless LAN

SSL VPN

USB Application

System Maintenance

Diagnostics

External Devices

---

Support Area

Product Registration

**Online Status**

---

**Physical Connection** System Uptime: 0:8:44

IPv4		IPv6	
LAN Status	Primary DNS: 194.72.0.98	Secondary DNS: 213.120.234.26	
IP Address	TX Packets	RX Packets	
192.168.1.1	0	0	

---

**WAN 1 Status** >> Release

Enable	Line	Name	Mode	Up Time		
Yes	VDSL2		DHCP Client	0:06:58		
IP	GW IP	TX Packets	TX Rate(Bps)	RX Packets	RX Rate(Bps)	
217.34.6.35	217.42.145.215	224580	805	339568	963	

---

**WAN 2 Status**

Enable	Line	Name	Mode	Up Time		
Yes	Ethernet		---	00:00:00		
IP	GW IP	TX Packets	TX Rate(Bps)	RX Packets	RX Rate(Bps)	
---	---	0	0	0	0	

---

**WAN 3 Status**

Enable	Line	Name	Mode	Up Time	Signal
Yes	USB		---	00:00:00	-
IP	GW IP	TX Packets	TX Rate(Bps)	RX Packets	RX Rate(Bps)
---	---	0	0	0	0

---

**VDSL2 Information** (VDSL2 Firmware Version: 8B0F07\_A/B/C )

Profile	State	UP Speed	Down Speed	SNR Upstream	SNR Downstream
17A	SHOWTIME	20000 (Kbps)	80000 (Kbps)	15 (0.1dB)	6 (0.1dB)

### 4.2.3 PPPoA connection with ADSL / ADSL2+

1. Go to [WAN] > [Internet Access]

Set the WAN1 Access Mode to PPPoE / PPPoA and click the Details Page button to proceed:

WAN >> Internet Access

Index	Physical Mode	Access Mode	
WAN1	ADSL / VDSL2	PPPoE / PPPoA	<a href="#">Details Page</a>
WAN2	Ethernet	None	<a href="#">Details Page</a>
WAN3	USB	None	<a href="#">Details Page</a>

2. On the PPPoE / PPPoA settings tab:

The details for the VPI and VCI settings for ADSL should be correct for UK usage, with 0 and 38 being the defaults. In most cases, it will not be necessary to change these.

The Modulation setting can be left on its default of Multimode which will auto-detect the correct ADSL type to use.

WAN >> Internet Access

WAN 1

PPPoE / PPPoA | MPoA / Static or Dynamic IP | IPv6

Enable  Disable

**ADSL Modem Settings**

Multi-PVC channel: Channel 1

VPI: 0

VCI: 38

Encapsulating Type: VC MUX

Protocol: PPPoA

Modulation: Multimode

**ISP Access Setup**

Username: ?3456@HG01.btclick.com

Password: ●●●●●●●●

More Options +

**PPP/MP Setup**

PPP Authentication: PAP or CHAP

IP Assignment (IPCP):  Static  Dynamic

Fixed IP Address: [ ]

[WAN IP Alias](#)

**Dial-Out Schedule**

Index(1-15) in [Schedule](#) Setup:

None => None

=> None => None

**PPPoE Pass-through**

For Wired LAN<sup>2</sup>

For Wireless LAN

Select the **Enable** radio button at the top of the page to ensure that the PPPoA interface is enabled.

Enter the ISP credentials into the **Username** and **Password** fields.

If your ISP has provided a static IP address, that can be specified by setting the **Fixed IP** setting to **Yes** and entering the IP in the **Fixed IP Address** field.

Click **OK** on this page to apply the changes and the router will then prompt to restart. Click the **OK** button to restart the router.

- Once the router has restarted, the **[Online Status] > [Physical Connection]** page will display the ADSL information and PPP connection status, if the WAN1 section shows an IP address, it has connected to the internet successfully:

Auto Logout IP6

Dashboard  
Quick Start Wizard  
Online Status  
**Physical Connection**  
Virtual WAN

---

WAN  
LAN  
NAT  
Firewall  
User Management  
Objects Setting  
CSM  
Bandwidth Management  
Applications  
VPN and Remote Access  
Certificate Management  
Wireless LAN  
SSL VPN  
USB Application  
System Maintenance  
Diagnostics  
External Devices

---

Support Area  
Product Registration

**Online Status**

---

**Physical Connection** System Uptime: 0:8:44

IPv4		IPv6	
<b>LAN Status</b>		Primary DNS: 194.72.0.98	
Secondary DNS: 213.120.234.26			
IP Address	TX Packets	RX Packets	
192.168.1.1	0	0	

---

**WAN 1 Status** >> Drop PPPoA

Enable	Line	Name	Mode	Up Time	
Yes	VDSL2		PPPoE	0:07:41	
IP	GW IP	TX Packets	TX Rate(Bps)	RX Packets	RX Rate(Bps)
217.34.6.35	217.42.145.215	224580	805	339568	963

---

**WAN 2 Status**

Enable	Line	Name	Mode	Up Time	
Yes	Ethernet		---	00:00:00	
IP	GW IP	TX Packets	TX Rate(Bps)	RX Packets	RX Rate(Bps)
---	---	0	0	0	0

---

**WAN 3 Status**

Enable	Line	Name	Mode	Up Time	Signal
Yes	USB		---	00:00:00	-
IP	GW IP	TX Packets	TX Rate(Bps)	RX Packets	RX Rate(Bps)
---	---	0	0	0	0

---

**VDSL2 Information** (VDSL2 Firmware Version: 8B0F07\_A/B/C)

Profile	State	UP Speed	Down Speed	SNR Upstream	SNR Downstream
17A	SHOWTIME	20000 (Kbps)	80000 (Kbps)	15 (0.1dB)	6 (0.1dB)



**Note**

If the WAN 1 IP address displayed begins with 172.16.x.x, it's possible that the ISP has not accepted the supplied Username and Password for the Internet connection.

Check that the ISP Access Setup - Username and Password match the details supplied by your ISP.

### 4.3 WAN2 – Ethernet Connection Setup

The WAN2 interface of the Vigor 2765 router can connect to an ISP supplied router or another network with an Internet connection.

The Ethernet WAN port is shared with the LAN port P4 and must be configured to operate in WAN mode as shown in section 5.3.1 **Enabling the Ethernet WAN Port**

If you are using a modem and your ISP has supplied you with a Username and Password to connect to the Internet, see section 5.3.2 **PPPoE**

If the router is connected to a modem and the ISP does not supply or require a Username and Password to connect to the Internet, or you are connecting to another router or network, see section 5.3.3 **Static or Dynamic IP**

### 4.3.1 Enabling the Ethernet WAN Port

The Vigor 2765 series router uses port P4 to connect to an Ethernet based Internet connection. In its default state, the port P4 operates as a standard LAN port and the WAN2 (Ethernet WAN) options cannot be selected in the router's web interface.

To enable the router's Ethernet WAN port on port P4 instead of LAN mode:

1. Go to [WAN] > [General Setup] and click WAN2

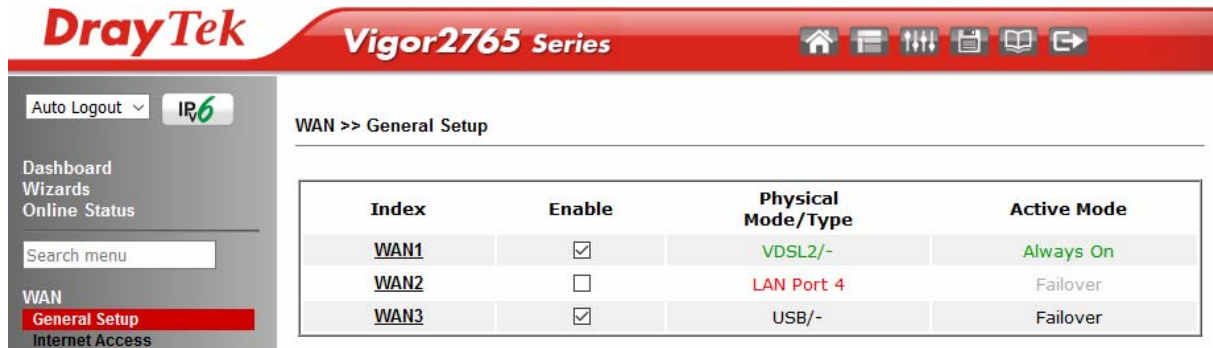

Index	Enable	Physical Mode/Type	Active Mode
WAN1	<input checked="" type="checkbox"/>	VDSL2/-	Always On
WAN2	<input type="checkbox"/>	LAN Port 4	Failover
WAN3	<input checked="" type="checkbox"/>	USB/-	Failover

2. In its default state, the Enable option is set to No, which uses port P4 as a standard LAN port:



WAN 2

Enable: No

Display Name:

Physical Mode: Ethernet

Physical Type: Auto negotiation

Active Mode: Failover

3. Set the Enable option for WAN2 to Yes, this enables the other options on this page.  
Set the Active Mode to Always On to make the Ethernet port the active Internet connection.

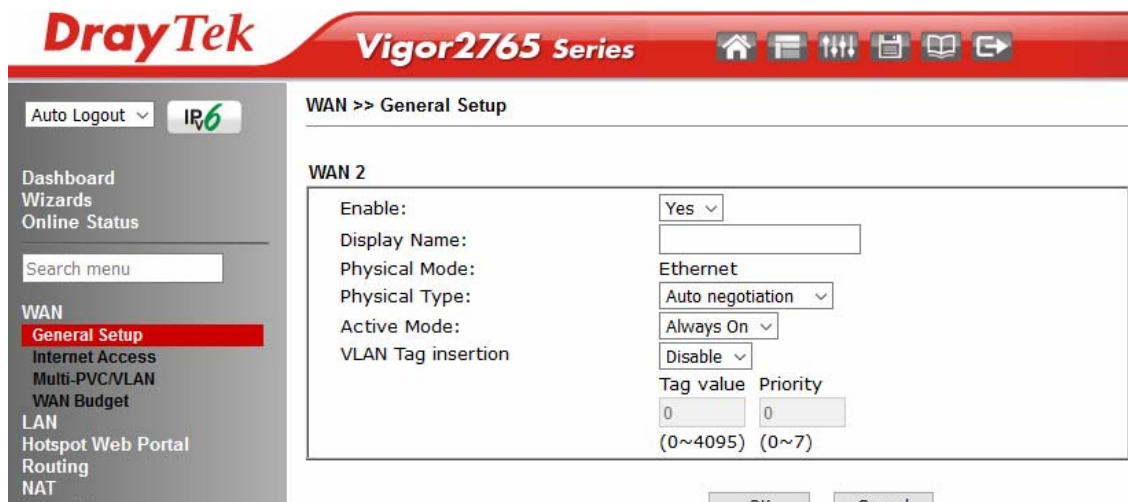

WAN 2

Enable: Yes

Display Name:

Physical Mode: Ethernet

Physical Type: Auto negotiation

Active Mode: Always On

VLAN Tag insertion: Disable

Tag value: 0 Priority: 0  
(0~4095) (0~7)

OK Cancel

- Click OK to apply the change and the router will prompt to restart. Click OK to restart the router.

System Maintenance >> Reboot System

Reboot System

Do you want to reboot your router ?

Using current configuration  
 Using factory default configuration

OK

Once the router has restarted, the WAN2 - Ethernet WAN interface can be configured on the router, as shown in the following two sections.



**Note**

To reconfigure port P4 for LAN use, go to [WAN] > [General Setup] > [WAN2] and set the Enable option to No.

Once the router has been restarted to apply the change, the port will operate in LAN mode.

### 4.3.2 PPPoE

This connection method will typically be used with a modem such as the Vigor 130 VDSL2 modem, which passes through the PPPoE connection from the ISP to the router.

- Go to [WAN] > [Internet Access]

Firstly set the WAN2 Access Mode to PPPoE, then click the Details Page button to proceed:

Index	Display Name	Physical Mode	Access Mode	
WAN1		ADSL / VDSL2	None	Details Page
WAN2		Ethernet	PPPoE	Details Page
WAN3		USB	None	Details Page

- In the PPPoE settings tab:

Select the Enable radio button at the top of the page to ensure that the PPPoE interface is enabled.

Input the username into the Username field and password in the Password field, as required. The Service Name does not need to be specified.

If your ISP has provided a static IP address, that can be specified by setting the Fixed IP setting to Yes and entering the IP in the Fixed IP Address field.



**WAN 2**

PPPoE	Static or Dynamic IP	PPTP/L2TP	IPv6
<input checked="" type="radio"/> Enable <input type="radio"/> Disable			
<b>ISP Access Setup</b> Service Name (Optional) <input type="text"/> Username <input type="text" value="A123456@HG00.btclick.c"/> Password <input type="password" value="....."/> Index(1-15) in <u>Schedule</u> Setup: => <input type="text"/> , <input type="text"/> , <input type="text"/> , <input type="text"/>		<b>PPP/MP Setup</b> PPP Authentication <input type="text" value="PAP or CHAP"/> Idle Timeout <input type="text" value="-1"/> second(s) <b>IP Address Assignment Method (IPCP)</b> <input type="text" value="WAN IP Alias"/> Fixed IP: <input type="radio"/> Yes <input checked="" type="radio"/> No (Dynamic IP) Fixed IP Address <input type="text"/> <hr/> <input checked="" type="radio"/> Default MAC Address <input type="radio"/> Specify a MAC Address	

Click OK on that page to save the settings and the router will then prompt to restart, allow it to restart to properly apply the changes.

Once the router has restarted, log back into the web interface and select [Online Status] > [Physical connection], if it has connected, the relevant WAN Interface status text will be in green along with an IP address which indicates that the connection is active and ready for use.

### 4.3.3 Static or Dynamic IP

1. Go to [WAN] > [Internet Access]

Firstly set the WAN2 Access Mode to Static or Dynamic IP, then click the Details Page button to proceed:

WAN >> Internet Access

Index	Display Name	Physical Mode	Access Mode	
WAN1		ADSL / VDSL2	None	Details Page
WAN2		Ethernet	Static or Dynamic IP	Details Page
WAN3		USB	None	Details Page

2. In the Static or Dynamic IP settings:

Select the Enable option and select Obtain an IP address automatically which will obtain an IP from the ISP with DHCP.

If your ISP has provided a static IP range, with a Network address and a Subnet Mask, specify that with the Specify an IP address option.

WAN 2

PPPoE	Static or Dynamic IP	PPTP/L2TP	IPv6
<input checked="" type="radio"/> Enable <input type="radio"/> Disable			
<b>Keep WAN Connection</b> <input type="checkbox"/> Enable PING to keep alive PING to the IP <input type="text"/> PING Interval <input type="text"/> minute(s)		<b>WAN IP Network Settings</b> <b>WAN IP Alias</b> <input checked="" type="radio"/> Obtain an IP address automatically Router Name <input type="text"/> * Domain Name <input type="text"/> * <input type="checkbox"/> DHCP Client Identifier * Username <input type="text"/> Password <input type="text"/> <input type="radio"/> Specify an IP address IP Address <input type="text"/> Subnet Mask <input type="text"/> Gateway IP Address <input type="text"/>	
<b>WAN Connection Detection</b> Mode <input type="text"/> ARP Detect			
<b>MTU</b> <input type="text"/> 1500 (Max:1500) Path MTU Discovery <input type="text"/> Detect			

Click **OK** on this page to apply the changes and the router will then prompt to restart. Click to restart the router.

Once the router has restarted, log back into the web interface and select **[Online Status] > [Physical connection]**, if it has connected, the relevant **WAN Interface** status text will be in green along with an IP address which indicates that the connection is active and ready for use.

## 4.4 WAN3 / WAN4 – 3G / 4G USB Modem Setup

The 3G / 4G USB modem facility can be used either as a primary Internet connection or as a backup that will only activate when other WAN interfaces are offline. It allows a supported USB modem to provide internet access through the router.

The list of supported modems can be found under:  
[USB Application] > [Modem Support List]

or on the DrayTek UK site:

<https://www.draytek.co.uk/support/guides/usb-3g-4g-modem-support-list>

There are two USB modem connection modes available:

**PPP mode** is used where the modem provides a dial-up interface and would typically require software to perform dialing and provide status information and diagnostics when used with a PC.

**DHCP mode** is used where the modem operates as a virtual network adapter / router and will usually have diagnostics and usage information shown in a web interface.

When configuring the 3G / 4G modem, the router will require the correct **APN** (Access Point Name) details and a username and password with some ISPs. If those details are not set, the mobile network may reject the connection attempts of the router, which will result in the router showing no signal / no IP address.

### 4.4.1 PPP Mode

To set up the USB WAN for PPP mode, go to [WAN] > [Internet Access]  
Select **3G/4G USB Modem (PPP mode)** from the drop-down box

Click the **Details Page** button to continue:

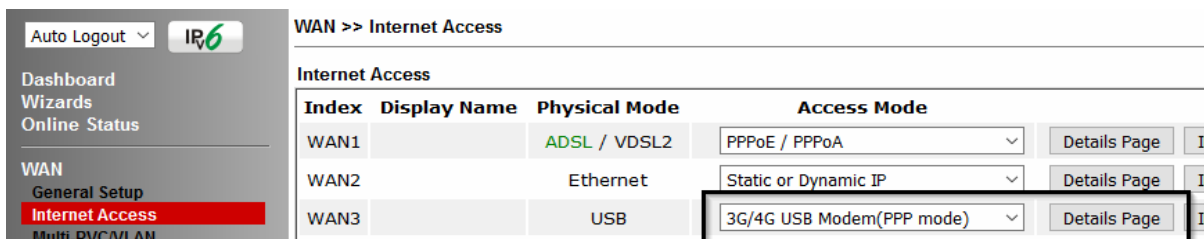

WAN >> Internet Access

Internet Access

Index	Display Name	Physical Mode	Access Mode	
WAN1		ADSL / VDSL2	PPPoE / PPPoA	Details Page
WAN2		Ethernet	Static or Dynamic IP	Details Page
WAN3		USB	3G/4G USB Modem(PPP mode)	Details Page

In the USB WAN settings, select the **Enable** option to enable the WAN interface.

The Modem String values typically do not need to be changed.

Enter the **PPP Username** and **PPP Password** if your ISP requires these to authenticate.

Enter a **SIM PIN** code only if your SIM card has a PIN set on it, otherwise leave this blank.

WAN 3

3G/4G USB Modem(PPP mode) | 3G/4G USB Modem(DHCP mode) | IPv6 | [Modem Support List](#)

3G/4G USB Modem(PPP mode)  Enable  Disable

SIM PIN code

Modem Initial String   
(Default:AT&FE0V1X1&D2&C1S0=0)

APN Name

Modem Initial String2

Modem Dial String   
(Default:ATDT\*99#, CDMA:ATDT#777, TD-SCDMA:ATDT\*98\*1#)

Service Name  (Optional)

PPP Username  (Optional)

PPP Password  (Optional)

PPP Authentication

To set the APN Name, enter the APN required by the SIM card / network into the APN Name field and click the **Apply** button:

3G/4G USB Modem(PPP mode)  Enable  Disable

SIM PIN code

Modem Initial String   
(Default:AT&FE0V1X1&D2&C1S0=0)

APN Name

Modem Initial String2

Modem Dial String

This will move the APN Name into the Modem Initial String to indicate that it has been saved.

3G/4G USB Modem(PPP mode)  Enable  Disable

SIM PIN code

Modem Initial String   
(Default:AT&FE0V1X1&D2&C1S0=0)

APN Name

Modem Initial String2

Modem Dial String

Click **OK** to save and apply the changes.

If the modem is detected successfully, the WAN interface should be able to connect. Status information can be viewed on the **[Online Status] > [Physical Connection]** section as WAN3. If there is a successful connection, the WAN interface text will show in green and will show an IP address.

## 4.4.2 DHCP Mode

To set up the USB WAN for DHCP mode, go to [WAN] > [Internet Access]  
Select 3G/4G USB Modem (DHCP mode) from the drop-down box  
Click the Details Page button to continue:

Index	Display Name	Physical Mode	Access Mode	
WAN1		ADSL / VDSL2	PPPoE / PPPoA	Details Page
WAN2		Ethernet	Static or Dynamic IP	Details Page
WAN3		USB	3G/4G USB Modem(DHCP mode)	Details Page

In the USB WAN settings, select the **Enable** option to enable the WAN interface.  
Enter a **SIM PIN** code only if your SIM card has a PIN set on it, otherwise leave this blank.

**Network Mode** defaults to 4G/3G/2G which will auto-select the network type to connect to and will use whichever mode the base station recommends. Setting this to a specific mode will force that connection type, for instance "4G Only" will connect using 4G specifically

The APN Name will typically not need to be set with a USB modem that uses DHCP mode, however if the modem cannot connect then enter the APN for the SIM card used in the modem.

WAN >> Internet Access

**WAN 3**

3G/4G USB Modem(PPP mode) | 3G/4G USB Modem(DHCP mode) | IPv6 | [Modem Support List](#)

Enable  Disable

SIM PIN code

Network Mode  (Default:4G/3G/2G)

APN Name

LTE hardware version ---

**WAN Connection Detection**

Mode

MTU  (Default:1500)

Path MTU Discovery

Authentication

Username  (Optional)

Password  (Optional)

Click **OK** to save and apply the changes.

If the modem is detected successfully, the WAN interface should be able to connect. Status information can be viewed on the [Online Status] > [Physical Connection] section as **WAN3**. If there is a successful connection, the WAN interface text will show in green and will show an IP address.

## 5. Getting Further Help

If the router does not appear to be operating correctly or you cannot get online to the Internet, please visit our web site ([www.draytek.co.uk](http://www.draytek.co.uk)) for further troubleshooting advice or to contact our support technicians. Always have your serial number to hand.

Users in the UK/Ireland using qualifying products should visit for support options including email support, telephone support, our help knowledgebase and access to the UK user support forums.

If you are **outside** of the UK/Ireland, please contact your own local supplier, email to [support@draytek.com](mailto:support@draytek.com) or visit [www.draytek.com/support](http://www.draytek.com/support)

For warranty service, in the first instance, please contact the support services, as listed above, for help in diagnosing or eliminating the problem or issue. The support department can arrange repair or service if then deemed necessary.

The standard Vigor 2765 series warranty is 'Return to base' (RTB) unless you have VigorCare which provides enhanced services (see [www.draytek.co.uk/vigorcure](http://www.draytek.co.uk/vigorcure)).

You should keep your proof of purchase (original invoice) safely in case warranty or other service is ever required.

### 5.1 Additional Feature Setup

This is a quick setup guide to get you online with your new router. Your Vigor 2765 series router is capable of very much more and has a plethora of other features.

These are covered in the main user manual, which is available on the Downloads page:

<https://www.draytek.co.uk/support/downloads>

The online knowledgebase has additional information on how to configure the router's Internet connectivity and more advanced features:

<https://www.draytek.co.uk/support/product-knowledgebase>

### 5.2 Keep up to date with our mailing list

Now that you have your DrayTek product, you should keep up to date with product updates (firmware), security advisories and other product news, advice or special offers. Users in the UK/Ireland can subscribe to our mailing list. For details and to subscribe, please visit

In other countries or regions, please contact your local distributor/supplier for local options.

## 5.3 Firmware Updates

It is strongly recommended that you keep your router firmware up to date with the latest version in order to have all of the latest security and feature improvements.

Always obtain firmware from official sources, i.e. (for UK/Ireland users).

There are two firmware file types:

.all - upgrade retaining all previous settings

.rst - upgrade and reset to factory default

It is recommended to take a configuration backup prior to upgrading the firmware.

## 5.4 Security & Router Best Practice

Your router is the gateway to an entire business network and data. Even the best security equipment requires correct usage in order to ensure that its features are effective.

There are many simple practices that every router user should adopt to help reduce the risk to their network or business as well as some very common and simple mistakes that people habitually make - simple mistakes which could then be exploited by others.

We've produced our free guide "**Router Best Practice**" which contains essential information for anyone installing, configuring or using a broadband router or wireless LAN.

Available to download: <https://www.draytek.co.uk/best>