

Xerox® C230 Color Printer Quick Reference Guide



Print

Printing from a Computer

 **Note:** For labels, card stock, and envelopes, set the paper size and type in the printer before printing the document.

1. From the document that you are trying to print, open the Print dialog.
2. If necessary, adjust the settings.
3. Print the document.

Printing From a Mobile Device

Printing from a Mobile Device using Mopria™ Print Service

 **Note:** This feature is available only in some printer models.

Mopria Print Service is a mobile printing solution for mobile devices running on Android™ version 10.0 or later. It allows you to print directly to any Mopria-certified printer.

 **Note:** Make sure that you download the Mopria Print Service application from the Google Play™ store and enable it in the mobile device.

1. From your Android mobile device, launch a compatible application or select a document from your file manager.
2. Tap  > **Print**.
3. Select a printer, and then adjust the settings, if necessary.

4. Tap .

Printing from a Mobile Device using AirPrint®

 **Note:** This feature is available only in some printer models.

The AirPrint software feature is a mobile printing solution that allows you to print directly from Apple devices to an AirPrint-certified printer.

- Make sure that the Apple device and the printer are connected to the same network. If the network has multiple wireless hubs, then make sure that both devices are connected to the same subnet.
 - This application is supported only in some Apple devices.
1. From your mobile device, select a document from your file manager or launch a compatible application.

2. Tap  > **Print**.



3. Select a printer, and then adjust the settings, if necessary.
4. Print the document.

Printing from a Mobile Device using Wi-Fi Direct®

 **Note:** This feature is available only in some printer models.

Wi-Fi Direct is a printing service that lets you print to any Wi-Fi Direct-ready printer.

 **Note:** Make sure that the mobile device is connected to the printer wireless network. For more information, see [Connecting a Mobile Device to the Printer](#).

1. From your mobile device, launch a compatible application or select a document from your file manager.
2. Depending on your mobile device, do one of the following:
 - Tap  > **Print**.
 - Tap  > **Print**.
 - Tap  > **Print**.
3. Select a printer, and then adjust the settings, if necessary.
4. Print the document.

Maintain the Printer

Replacing a Print Cartridge

 **Note:** If the tray is extended, then remove it before replacing a cartridge.

1. Open the front door, then firmly push it down.

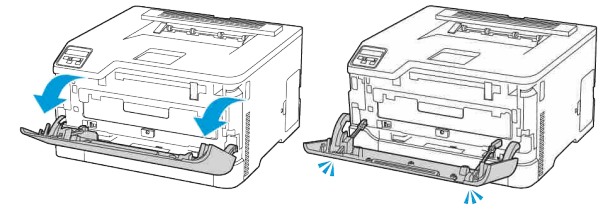

2. Pull out the print cartridge tray.

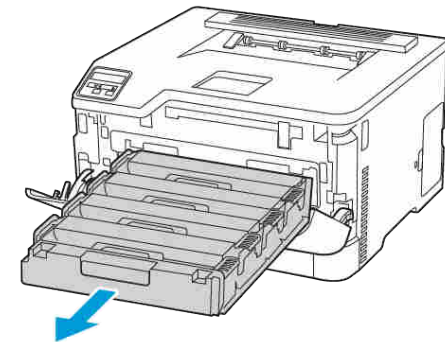

3. Remove the used print cartridge.

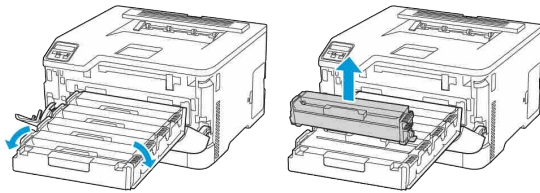

4. Unpack the new print cartridge.

Warning—Potential Damage: Do not expose the underside of the print cartridge to direct light. Extended exposure to light may cause print quality problems.

Warning—Potential Damage: Do not touch the underside of the print cartridge. Doing so may affect the quality of future print jobs.



5. Insert the new print cartridge.

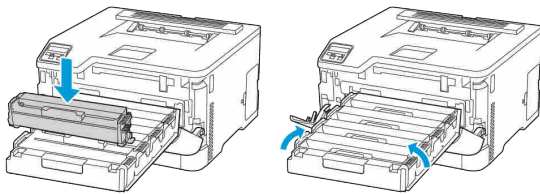

6. Insert the print cartridge tray, and then close the door.

Replacing the Waste Toner Bottle

1. Remove the used waste toner bottle.

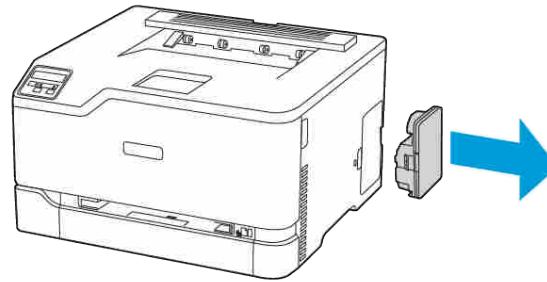

 **Note:** To avoid spilling the toner, place the bottle in an upright position.

2. Unpack the new waste toner bottle.
3. Insert the new waste toner bottle.

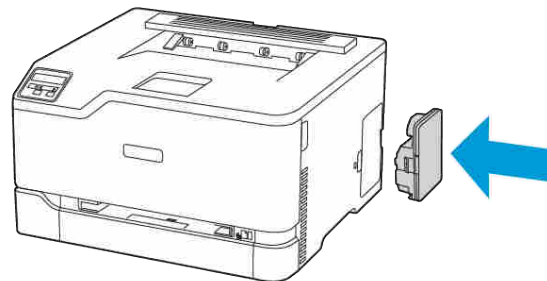

Loading the Tray

 **CAUTION—TIPPING HAZARD:** To reduce the risk of equipment instability, keep the tray closed until needed.

1. Remove the tray.

 **Note:** To avoid paper jams, do not remove the tray while the printer is busy.

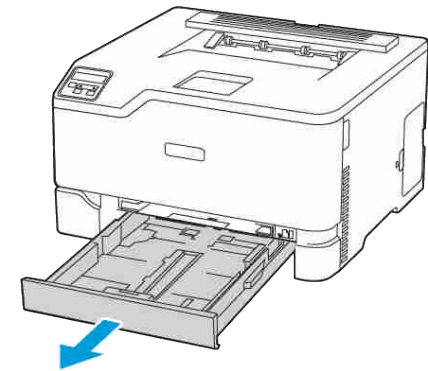

2. Flex, fan, then align the paper edges before loading.



3. Load the paper stack with the printable side face-up.
 - Load letterhead face-up with the header toward the back of the tray for one-sided printing.
 - Load letterhead face-down with the header toward the front of the tray for two-sided printing.
 - Do not slide paper into the tray.

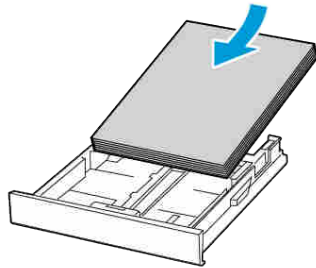

4. To avoid paper jams, make sure that the stack height is below the maximum paper fill indicator.

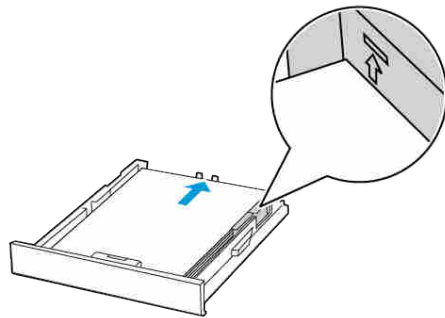

5. Adjust the guides to match the size of the paper that you are loading.

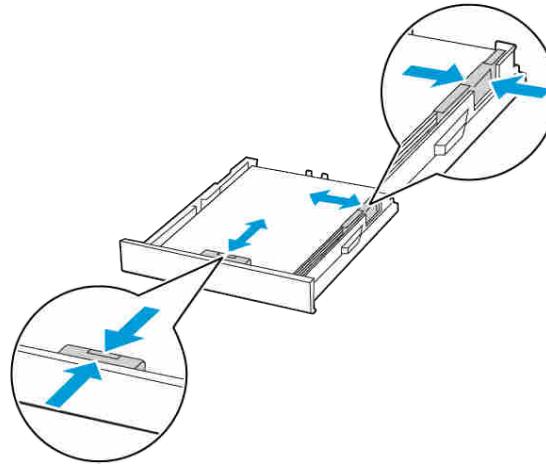

6. Insert the tray.
7. If necessary, set the paper size and paper type from the control panel to match the paper loaded.

Loading the Manual Feeder

1. Adjust the guide to match the size of the paper that you are loading.

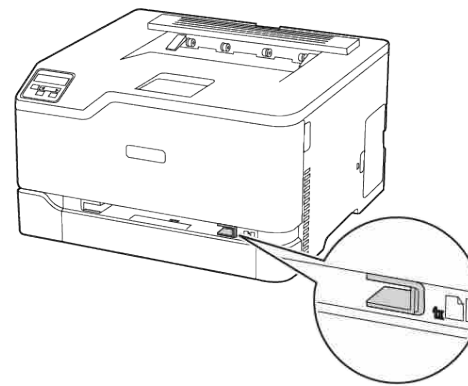

2. Load a sheet of paper with the printable side face-up.
 - Load letterhead with the printable side faceup and the top edge entering the printer first for one-sided printing.

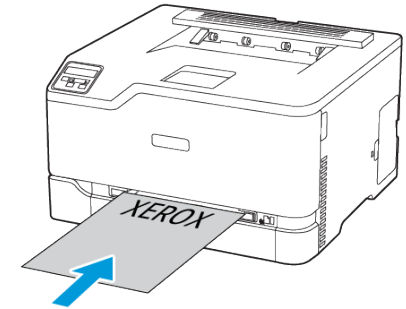

- Load letterhead with the printable side face-down and the top edge entering the printer last for two-sided printing.

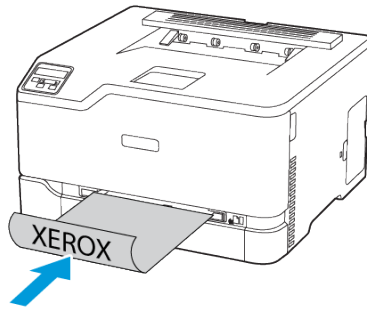

- Load envelope with the flap side down and against the right side of the paper guide.

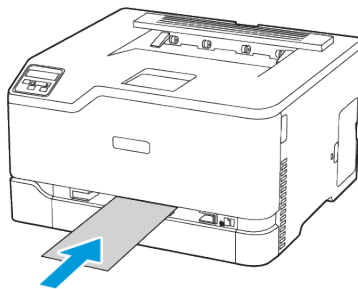

3. Feed the paper until its leading edge gets pulled in.
 - To avoid paper jams, do not force paper into the manual feeder.
 - Before loading another sheet, wait for a message to appear on the display.

Setting the Paper Size and Type

1. From the control panel, navigate to **Settings > PaperTray > Configuration > Paper Size/Type**, then select a paper source.

For non-touch-screen printer models, press  to navigate through the settings.

2. Set the paper size and type.

Updating Firmware

Some applications require a minimum device firmware level to operate correctly.

For more information on updating the device firmware, contact your representative.

1. Open a web browser, and then type the printer IP address in the address field.
 - View the printer IP address on the printer home screen. The IP address appears as four sets of numbers separated by periods, such as 123.123.123.123.
 - If you are using a proxy server, then temporarily disable it to load the web page correctly.
2. Click **Settings > Device > Update Firmware**.
3. Do either of the following:
 - Click **Check for updates > I agree, start update**.
 - Upload the flash file.
 1. Browse to the flash file.
 2. Click **Upload > Start**.

Configuring Wi-Fi Direct

Wi-Fi Direct is a Wi-Fi-based peer-to-peer technology that allows wireless devices to connect directly to a Wi-Fi Direct-enabled printer without using an access point (wireless router).

1. From the control panel, navigate to **Settings > Network/Ports > Wi-Fi Direct**.
For non-touch-screen printer models, to navigate through the settings, press **OK**.

2. Configure the settings.

- **Enable Wi-Fi Direct:** Enables the printer to broadcast its own Wi-Fi Direct network.
- **Wi-Fi Direct Name:** Assigns a name for the Wi-Fi Direct network.
- **Wi-Fi Direct Password:** Assigns the password for negotiating the wireless security when using the peer-to-peer connection.
- **Show Password on Setup Page:** Shows the password on the Network Setup Page.
- **Auto-Accept Push Button Requests:** Lets the printer accept connection requests automatically.

 **Note:** Accepting push-button requests automatically is not secured.

- By default, the Wi-Fi Direct network password is not visible on the printer display. To show the password, enable the password peek icon. From the control panel, navigate to **Settings > Security > Miscellaneous > Enable Password/PIN Reveal**.
- To know the password of the Wi-Fi Direct network without showing it on the printer display, from the control panel navigate to **Settings > Reports > Network > Network Setup Page**.

Connecting a Mobile Device to the Printer

Before connecting your mobile device, make sure that Wi-Fi Direct has been configured. For more information, see [Configuring Wi-Fi Direct](#).

Connecting Using Wi-Fi Direct

 **Note:** These instructions apply only to Android mobile devices.

1. From the mobile device, go to the settings menu.
2. Enable **Wi-Fi**, and then tap **Wi-Fi Direct**.
3. Select the printer Wi-Fi Direct name.
4. Confirm the connection on the printer control panel.

Connecting Using Wi-Fi

1. From the mobile device, go to the settings menu.
2. Tap **Wi-Fi**, and then select the printer Wi-Fi Direct name.

 **Note:** The string DIRECT-xy, where x and y are two random characters, is added before the Wi-Fi Direct name.

3. Enter the Wi-Fi Direct password.

Connecting the Printer to a Wi-Fi Network

 **Note:** This feature is available only in some printer models.

Before you begin, make sure that:

- Active Adapter is set to Auto. From the control panel, navigate to **Settings > Network/Ports > Network Overview > Active Adapter**.
For non-touch-screen printer models, to navigate through the settings, press **OK**.
- The Ethernet cable is not connected to the printer.

Using the Wireless Setup Wizard in the Printer

- These instructions apply only to some printer models.
 - Before using the wizard, make sure that the printer firmware is updated.
1. From the home screen, touch the **Wi-Fi** icon, then touch **Set up now**.
 2. Select a Wi-Fi network, and then type the network password.
 3. Touch **Done**.

Using the Printer Control Panel

1. From the control panel, navigate to **Settings > Network/Ports > Wireless > Setup On Printer Panel**.
For non-touch-screen printer models, to navigate through the settings, press **OK**.
2. Select a Wi-Fi network, and then type the network password.
For Wi-Fi-network-ready printer models, a prompt to set up the Wi-Fi network appears during initial setup.

Clearing Jams

Avoiding Jams

Load Paper Properly

- Make sure that the paper lies flat in the tray.

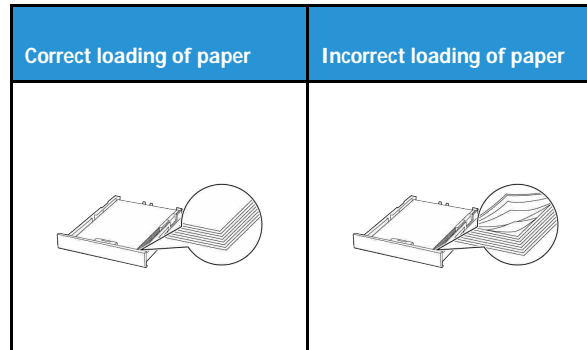

- Do not load or remove a tray while the printer is printing.
- Do not load too much paper. Make sure that the stack height is below the maximum paper fill indicator.
- Do not slide paper into the tray. Load paper as shown in the illustration.

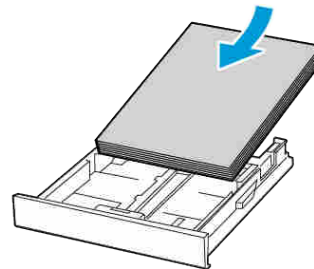

- Make sure that the paper guides are positioned correctly and are not pressing tightly against the paper or envelopes.
- Push the tray firmly into the printer after loading paper.

Use Recommended Paper

- Use only recommended paper or specialty media.
- Do not load paper that is wrinkled, creased, damp, bent, or curled.
- Flex, fan, and align the paper edges before loading.

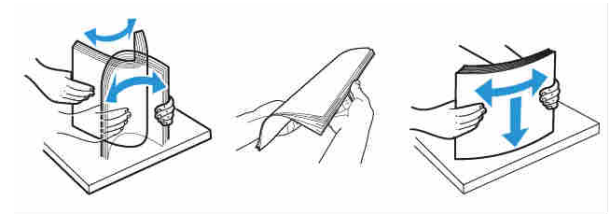

- Do not use paper that has been cut or trimmed by hand.
- Do not mix paper sizes, weights, or types in the same tray.
- Make sure that the paper size and type are set correctly on the computer or printer control panel.
- Store paper according to manufacturer recommendations.

Identifying Jam Locations

- When Jam Assist is set to **On**, the printer might attempt to flush blank pages or pages with partial prints after a jammed page has been cleared. Check your printed output for blank pages.
- When Jam Recovery is set to **On** or **Auto**, the printer reprints jammed pages.

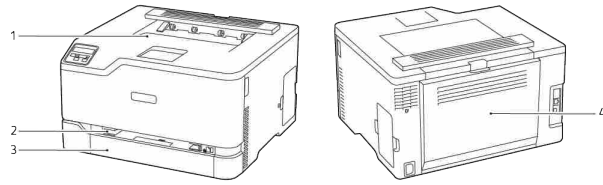

- 1. Standard output tray
- 2. Manual feeder
- 3. Standard tray
- 4. Door B

Paper Jam in the Standard Tray

1. Open door B.



CAUTION—HOT SURFACE: The inside of the printer might be hot. To reduce the risk of injury from a hot component, allow the surface to cool before touching it.

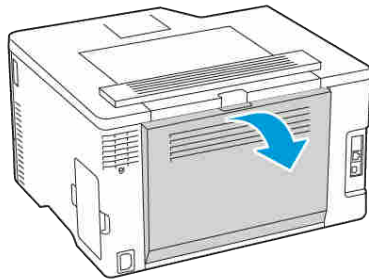

2. Remove the jammed paper.



Note: Make sure that all paper fragments are removed.

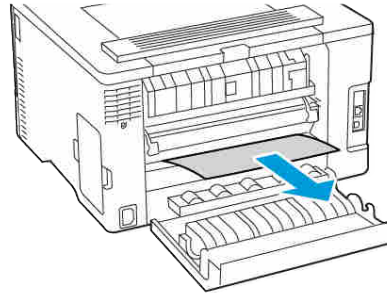

3. Close the door.
4. Remove the tray and the manual feeder.

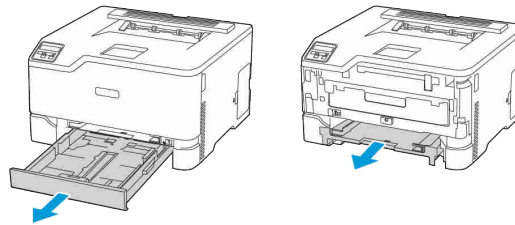

5. Remove the jammed paper.



Note: Make sure that all paper fragments are removed.

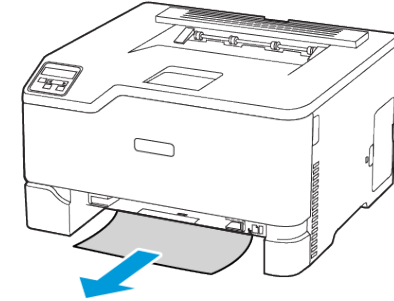

6. Insert the manual feeder and the tray.

Paper Jam in the Optional Tray

1. Open door B.



CAUTION—HOT SURFACE: The inside of the printer might be hot. To reduce the risk of injury from a hot component, allow the surface to cool before touching it.

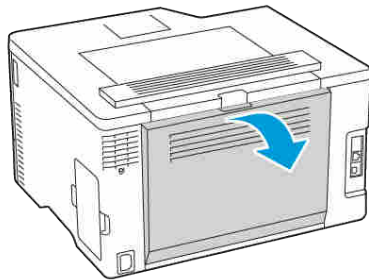

2. Remove the jammed paper.



Note: Make sure that all paper fragments are removed.

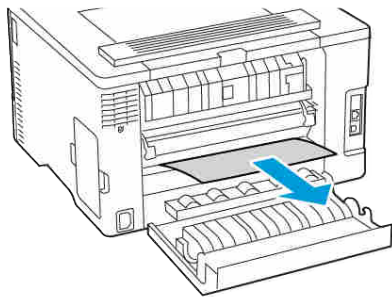

3. Close the door.
4. Open door E.

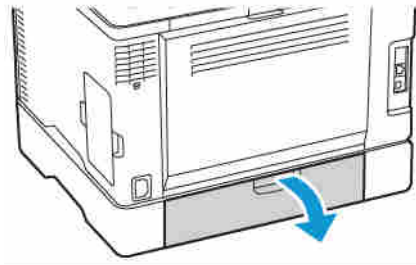

5. Remove the jammed paper.



Note: Make sure that all paper fragments are removed.

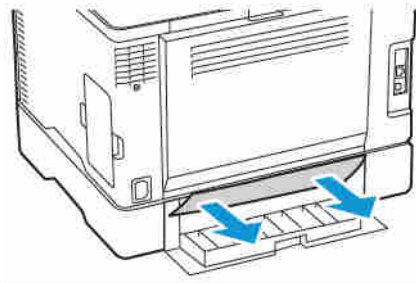

6. Close the door.
7. Remove the optional tray.



8. Remove the jammed paper.



Note: Make sure that all paper fragments are removed.

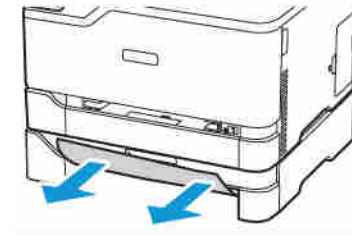

9. Insert the tray.

Paper Jam in the Standard Output Tray

Remove the jammed paper.



Note: Make sure that all paper fragments are removed.

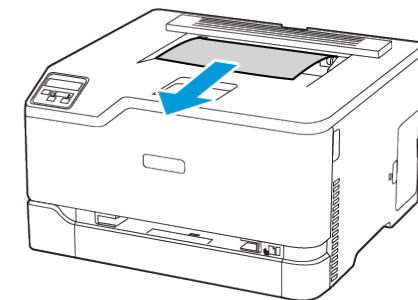

Paper Jam in the Manual Feeder

1. Remove the tray and the manual feeder.

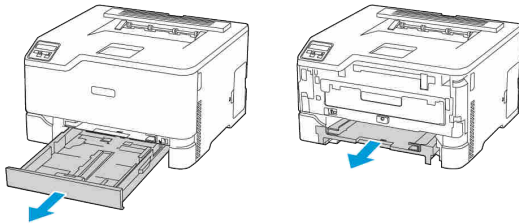

2. Remove the jammed paper.

 **Note:** Make sure that all paper fragments are removed.

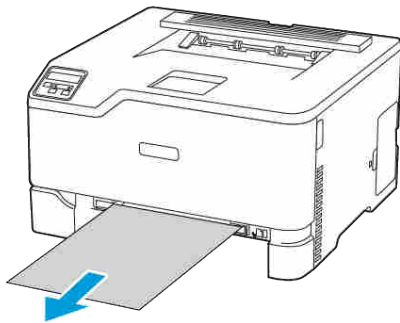

3. Insert the manual feeder and the tray.

Paper Jam in Door B

1. Open door B.



CAUTION—HOT SURFACE: The inside of the printer might be hot. To reduce the risk of injury from a hot component, allow the surface to cool before touching it.

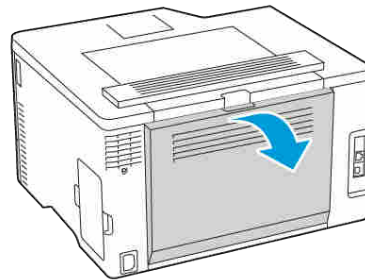

2. Remove the jammed paper from any of the following areas:

 **Note:** Make sure that all paper fragments are removed.

- Fuser area

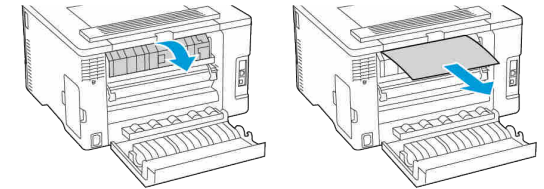

- Below the fuser area

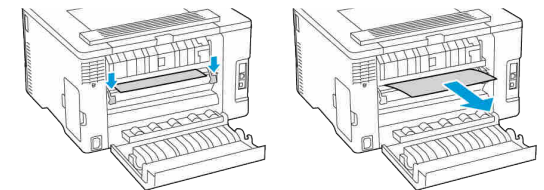

- Duplex unit

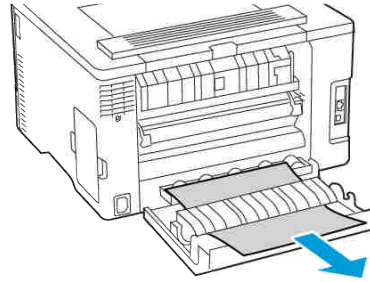

3. Close the door.

© 2021 Xerox Corporation. All rights reserved. Xerox® is a trademark of Xerox Corporation in the United States and other countries.

Apple®, iPad®, iPhone®, iPod®, iPod touch®, AirPrint® and the AirPrint Logo® are trademarks or registered trademarks of Apple Inc. in the U.S. and other countries. Google Cloud Print™ web printing service, Gmail™ webmail service, and Android™ mobile technology platform are trademarks of Google, Inc. Microsoft®, Windows Vista®, Windows®, Windows Server®, and OneDrive® are registered trademarks of Microsoft Corporation in the United States and other countries. Mopria is a trademark of the Mopria Alliance. Wi-Fi CERTIFIED Wi-Fi Direct® is a trademark of the Wi-Fi Alliance. All other trademarks are the property of their respective owners. 702P08609

BR32747

607E39340