



OWNER'S MANUAL

# LG CineBeam Laser 4K

DLP Projector

---

Please read the safety information carefully before using this product.

HU85LS

[www.lg.com](http://www.lg.com)

P/NO: SAC37813545 (2010-REV01)

Copyright © 2019 LG Electronics Inc. All Rights Reserved.

# CONTENTS

|  |           |
|--|-----------|
| <b>LICENSES</b>                                | <b>3</b>  |
| <b>Open Source Software Notice Information</b> | <b>4</b>  |
| <b>SAFETY PRECAUTIONS</b>                      | <b>5</b>  |
| <b>PREPARATION</b>                             | <b>17</b> |
| <b>INSTALLATION</b>                            | <b>24</b> |
| <b>MAGIC LIGHTING REMOTE</b>                   | <b>30</b> |
| <b>CONNECTING DEVICES</b>                      | <b>36</b> |
| <b>SPECIFICATIONS</b>                          | <b>40</b> |
| <b>SYMBOLS</b>                                 | <b>45</b> |
| <b>TROUBLESHOOTING</b>                         | <b>46</b> |

# LICENSES

Supported licenses may differ by model. For more information about licenses, visit [www.lg.com](http://www.lg.com).



The terms HDMI, HDMI High-Definition Multimedia Interface, and the HDMI Logo are trademarks or registered trademarks of HDMI Licensing Administrator, Inc.

Manufactured under license from Dolby Laboratories. Dolby, Dolby Vision, Dolby Audio, Dolby Atmos, and the double-D symbol are trademarks of Dolby Laboratories.

For DTS patents, see <http://patents.dts.com>. Manufactured under license from DTS Licensing Limited. DTS, the Symbol, & DTS and the Symbol together, DTS 2.0 Channel, DTS 2.0+Digital Out, DTS-HD, and DTS Virtual:X are registered trademarks or trademarks of DTS, Inc. in the United States and/or other countries. © DTS, Inc. All Rights Reserved.

*USB Type-C™ and USB-C™ are trademarks of USB Implementers Forum.*

POWERED BY

# QUICKSET®

**HEVC** Advance™  
Covered by Patents at [patentlist.hevcadvance.com](http://patentlist.hevcadvance.com)

## ! NOTE

- Images shown in this manual may differ from your projector.
- Your projector's OSD (On Screen Display) may differ slightly from that shown in this manual.

# Open Source Software Notice Information

To obtain the source code under GPL, LGPL, MPL, and other open source licenses, that is contained in this product, please visit <http://opensource.lge.com>.

In addition to the source code, all referred license terms, warranty disclaimers and copyright notices are available for download.

LG Electronics will also provide open source code to you on CD-ROM for a charge covering the cost of performing such distribution (such as the cost of media, shipping, and handling) upon email request to [opensource@lge.com](mailto:opensource@lge.com).

This offer is valid for a period of three years after our last shipment of this product.

This offer is valid to anyone in receipt of this information.

# SAFETY PRECAUTIONS

Please take note of the safety instructions to prevent any potential accident or misuse of the projector.

Child injuries can be prevented by following these simple safety precautions.

The precautions should be followed in the same manner when you store or move your existing projector.

- Safety precautions are given in two forms, i.e., **WARNING** and **CAUTION** as detailed below.

 **WARNING:** Failure to follow the instructions may cause serious injury and even death.

 **CAUTION:** Failure to follow the instructions may cause personal injury or product damage.

- Read the owner's manual carefully and keep it on hand.



The lightning flash with arrowhead symbol, within an equilateral triangle, is intended to alert the user to the presence of uninsulated dangerous voltage within the product's enclosure that may be of sufficient magnitude to constitute a risk of electric shock to persons.



The exclamation point within an equilateral triangle is intended to alert the user to the presence of important operating and maintenance (servicing) instructions in the literature accompanying the appliance.

## **WARNING/CAUTION**

- TO REDUCE THE RISK OF FIRE AND ELECTRIC SHOCK, DO NOT EXPOSE THIS PRODUCT TO RAIN OR MOISTURE.

**Read these instructions. Keep these instructions.  
Heed all warnings. Follow all instructions.**

## **Indoor Installation**

### **WARNING**

**Do not install products including projectors and remote controls in the following places:**

- Any place exposed to direct sunlight;
  - Any humid place such as bathroom;
  - Any place near hot objects such as flammables and stoves;
  - Any place where oil, oil mist, and steam can reach such as a worktop or places near a humidifier;
  - Any place where water can splash like a vase or the aquarium;
  - Any place that is dusty or exposed to wind and rain;
  - Any place that is under the air conditioner or is directly exposed to the wind from the air conditioner;
  - Any place near flammable materials such as flammable sprays, etc.; or
  - Any cupboard, bookcase shelf or cabinet without a fixture installed and any place where a pet can access.
- It may cause an electric shock, fire, malfunction, deformation or falling.

**Be careful the projector does not fall or is dropped when connecting an external device.**

- It may cause injury or damage to the product.

**Keep the following precautions in mind to prevent the temperature rise inside the projector:**

- Install the air vents at least 30 cm away from the wall.
- Do not install the product in a place where it cannot be ventilated, such as on a bookcase or in a closet.
- Do not install the product on carpet or cushion.
- Make sure that the air vents are not blocked with tablecloths, curtains, etc.
- It may cause a fire.

**For places where oil or oil mist can reach, do not install the product on a wall or ceiling.**

- The product may be damaged and fall.

**Do not allow a child to hang or climb on the installed projector.**

- The projector may fall and cause injury or death.

**When installing the product on the ceiling, observe the following precautions to prevent the projector from falling:**

- Contact the Customer Support Center for installation.
- Tighten the product by using the mounting equipment and M4 x 8 mm (M6 x 10 mm, 1/4-20UNC x 5.5 mm) screws that are approved by a professional technician.
- Do not use adhesive, lubricant, oil, etc. when using the mounting equipment.
- Do not tighten the screws with an excessive force since the projector may fall due to breakage of the screw connection part. (the recommended torque: 5-8 kgf.cm)
- A failure to follow the precautions may result in injury or death and product damage due to the fall of the product.

 **CAUTION**

**When moving the projector, be sure to turn off the power switch and disconnect the power plug, antenna cable and the connection cord between the devices.**

- A failure to do so may cause damage to the projector or the cord, resulting in a fire or electric shock.

**Do not install the projector on a shaky shelf, a slanted place, a place subject to vibrations, a place where the projector is not fully supported or on a fabric such as tablecloths.**

- It may cause injury as the projector falls or tips over, or it may cause a malfunction of the projector.

**To prevent damage to the power cord or plug, do not install the projector where the cord can be walked on.**

- It may cause a fire or electric shock.

**When installing the projector, do not install it too close to the wall.**

- The cable connection may be deteriorated or the projector and its cables may be damaged.

**When installing the projector on a cabinet or a shelf, make sure that the front end of the bottom of the projector does not come out.**

- The projector may fall due to the unbalance of the center of gravity and cause injury to people or a malfunction.



## When in Use

### WARNING

**When thunder or lightning strikes, unplug the power cord and do not touch the antenna wire.**

- It may cause an electric shock.

**If there is a gas leak from the gas lines, do not touch the outlet and be sure to vent by opening the window.**

- Sparks may be caused and lead to a fire or burns.

**When using the product with an external device such as a game console connected, keep the length of the connection line enough.**

- The product may fall over and cause injury or product damage.

**Do not scratch or give an impact on the projector with metallic materials or objects.**

- It may cause injury to people or damage to the product.

**Do not insert metallic objects including coins, hairpins or a piece of iron or flammable objects such as paper or matches into the projector.**

- It may cause a fire or electric shock.

**When replacing the batteries used for the remote control, be careful not to let children eat them and keep the batteries out of reach of children.**

- If a child swallows the battery, consult a doctor immediately.

**Keep the plastic wrapping of the product out of the reach of children.**

- If a child misuses it, it may suffocate the child.

**Do not touch near the vents during the operation or immediately after the power is turned off as they generate intense heat.**

- The heat does not indicate a defect or a problem of the projector when it is operating so use it with confidence.

**Do not look into the front of the lens when the projector is operating. Strong light is projected from the product which can cause injury to your eyes.**

**Never try to disassemble or modify the projector yourself. Always seek a qualified service technician or consult your dealer or local Service Center for inspection, adjustment or repairs.**

- It may cause a fire or electric shock.

 CAUTION

**Do not use any product that uses high voltage electricity near the projector. (e.g. An electric fly swatter)**

- It may cause a malfunction.

**Do not place any liquid containers such as a vase, pot, cup, cosmetics or medicine, decorations such as candles or any heavy objects on top of the projector.**

- Doing so may cause a fire, electric shock and injury due to failing.

**The surface of the AC adapter is hot, so be careful not to put the surface against your skin or let the children touch the surface during use. (Except for the models that do not use an adapter)**

**Do not hold or move the projector upside down by grabbing only the power cord, signal cable, or projection mirror.**

- Doing so may damage the product or cause an electric shock or fire.

**Even if the projector is turned off with the remote control or the button, the power is not completely cut off if the power cord is plugged in.**

**If you use headphones or earphones, do not use them at high volume or for a long period of time. (It applies only to the models that support headphones (earphones).)**

- Doing so may damage your hearing.

**Do not start the projector when the volume is high.**

- A loud volume can cause hearing loss.

**Do not use or store the projector outdoors for an extended period of time.**

**Do not touch the projector's lens or give an impact on it.**

- It may cause damage to the product.

**Do not block the light from the projector lens with a person, book or other objects.**

- If the light from the projector shines on an object for a long time, it can cause fire due to the heat of such light. Also, the reflected light can heat the lens and cause damage to the projector.

**Do not mix old and new batteries together.**

- It may cause battery rupture or fire due to liquid leakage or may cause electrical shock.

**When replacing the batteries, make sure that they are properly installed according to the polarities (+, -).**

- Battery rupture or leakage may lead to fire, explosion, injury or contamination (damage) of the surrounding area.

**Do not expose the batteries to direct sunlight, fireplace, electric heater, high temperature above 60 °C, excessively humid places or excessive heat.**

- It can cause an explosion or fire.

**Do not throw or disassemble the battery.**

- It can cause a fire and explosion due to battery damage.

**Do not carelessly throw away old batteries.**

- It can cause an explosion or fire. The disposal method may vary by country and region. Dispose of it in an appropriate manner.

**Risk of fire or explosion if the battery is replaced by an incorrect type.**

## **Power**



**Make sure the power plug is securely plugged in to prevent it from shaking.**

- If the connection is unstable, it may cause a fire.

**Do not plug too many devices into one multi-power outlet.**

- This may result in fire due to the power outlet overheating.

**Do not insert a metal object such as chopsticks into the other end of the power plug while it is plugged into a wall outlet. Also, do not touch the power plug immediately after unplugging it from the outlet.**

- It can cause an electric shock.

**Connect the power plug to a grounded outlet or multi-tap. (Except for any device without ground connection)**

- A failure to do so may cause an electric shock due to a malfunction or electrical short.

**Never touch the power plug with wet hands.**

- It may cause an electric shock.

**Disconnect the power plug from the outlet when you are not using the projector for a long time or absent.**

- Dust collects and may cause an electric shock and fire caused by a short circuit due to heat, ignition and insulation/degradation.

**The Power Plug is the disconnecting device. In case of an emergency, the Power Plug must remain readily accessible.**

**If any of the following occurs, it could be a malfunction of the product, so you must immediately turn the projector off, unplug the power cord from the outlet, and contact the service center:**

- When the product is damaged;
  - When the product fails;
  - When there is a foreign substance inside the product; or
  - When the product smokes or smells.
- It may cause a fire or electric shock.

 **CAUTION**

**Do not unplug or plug the power plug from/in the outlet while the power switch is on. (Do not use the power plug as a switch.)**

- It may cause a fire or malfunction.

**When removing the AC adapter or power cord, be sure to hold the plug part.**

- A failure to do so may cause a fire or damage to the product.

**Do not damage the AC adapter, power cord or power plug, place heavy objects on them or give an impact on them.**

- It may cause a fire, electric shock or damage to the product.

**Attach the power cord and AC adapter connected to the projector in a way that they are fully seated.**

- Poor contact can cause a malfunction of the product and fire.

**If there is dust on the pin part of the power plug or the outlet, clean it thoroughly.**

- It may cause a fire.

**Keep the power cord away from heat sources.**

- The coating of the cord may melt and cause a fire or electric shock.

**Use only the authorized power cord or AC adapter supplied by LG Electronics. Do not use any other products.**

- It may cause a malfunction of the product, fire or electric shock.

## Cleaning

### WARNING

**Do not spray water directly onto the projector when cleaning it.**

- It may cause a fire or electric shock.

### CAUTION

**How to clean the projector**

- Disconnect the plug from the outlet before cleaning.
- Do not wipe the optical system (the lens and mirror) immediately after the power is turned off.
- Do not spray the water with a sprayer on the product or wipe the product with a damp cloth.
- Wipe the product gently with a soft cloth.
- Do not use any detergents, automotive or industrial polishes, abrasives, waxes, benzenes or alcohols.
- It may cause a fire, electric shock or damage to the projector (deformation, corrosion, and breakage).

**How to clean the lens**

- Clean the lens if any dust or smudge appears on the surface of the lens.
- Clean the surface of the lens with an air sprayer or a soft, dry cloth.
- To remove dust or stains on the lens, use a compressed air duster, cotton swab, or soft cloth to gently wipe the lens.
- Never clean the lens when the projector is operating or immediately after the projector is turned off.
- Do not use any detergents, automotive or industrial polishes, abrasives, waxes, benzenes, alcohols, water, etc. on the lens, as they will damage the projector.

**Consult your dealer or the service center for cleaning the interior of the product once a year.**

- If you do not clean the interior of the projector for a long time while dust collects, it may cause a fire or malfunction.

## Laser

### WARNING

- You risk being exposed to laser radiation if you manipulate or alter the product in a way not specified in the user manual.
- Be sure not to let infants or people with diseases directly watch the light source.

### CAUTION

- This product is a class 1 laser device that meets IEC 60825-1.

### **Built-in laser standard (class 4 laser module)**

- Blue
  - Wavelength: 448 nm - 462 nm
  - Light output: approx. 95 W x 2
- Red
  - Wavelength: 636 nm - 642 nm
  - Light output: approx. 2.5 W x 12

### **Product Laser Class Label**

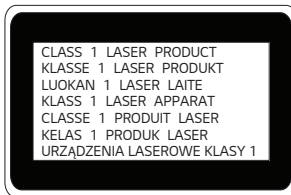

The laser class label of product is attached to the bottom of the product.



# PREPARATION

The pictures may differ slightly from the actual product.

## Accessories

Accessories included with the projector are show below.

Accessories are subject to change without prior notice.

New accessories may be added or old ones removed.

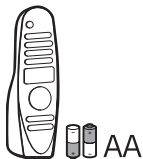

Magic Lighting Remote  
Two AA Batteries



Owner's Manual



Power cord



Edge guards

- When connecting an HDMI or USB cable, or connecting a USB flash drive to the HDMI or USB port, use a product that has a width of 18 mm or less and a height of 10 mm or less. If the USB cable or USB flash drive does not fit the USB ports of the projector, use an extension cable that supports USB 2.0.

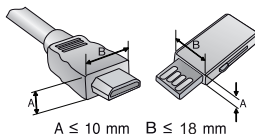

- When connecting two USB devices at the same time, each one should have bezels less than 8.5 mm thick.
- Use a certified cable with the HDMI logo attached.
- If you do not use a certified HDMI cable, the screen may not display or a connection error may occur. (Recommended HDMI cable types)
  - Ultra High-Speed HDMI®/™ Cable (3 m or less)

## Optional Extras

To purchase optional accessories, visit an electronics store or online shopping site or contact the retail store where you purchased the product. Optional accessories are subject to change without prior notice.



Projection Screen



HDMI Cable



USB-C Cable



Optical Cable

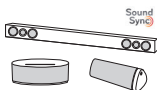

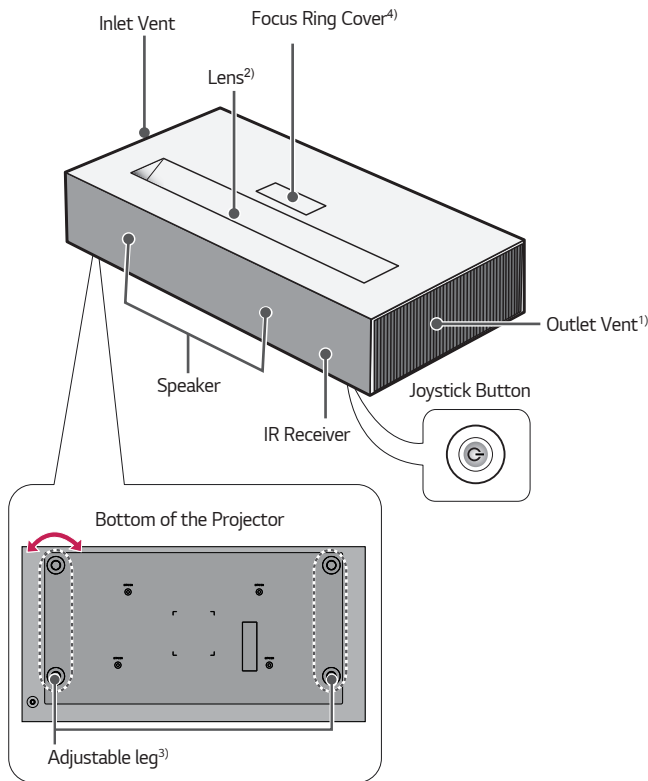

LG Audio Device

## Parts and Components

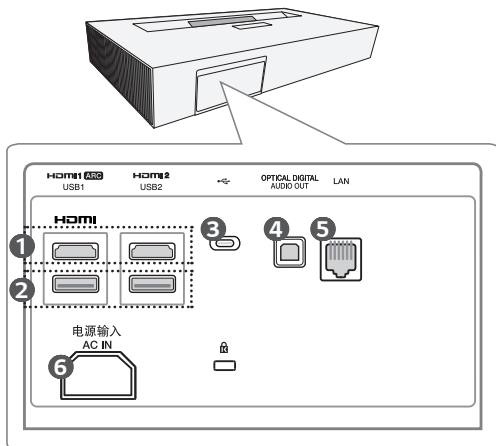

- 1) Due to the high temperature of vent area, do not get close to the vent area.
- 2) Do not touch the lens when using the projector. The lens may be damaged.  
(Keep lens away from sharp objects.)
- 3) Turn the adjustable leg left or right to adjust the angle.
- 4) Be careful not to get your fingers caught when closing the projector's door.  
(This may cause injury to people or a malfunction of the product.)



- 1 **HDMI** Port
- 2 USB 2.0 Port
- 3  (USB-C Port)
- 4 **OPTICAL DIGITAL AUDIO OUT** Port
- 5 **LAN** Port
- 6 电源输入 **AC IN** (AC IN Port)

## Using the Joystick Button

You can operate the projector by pressing the button or moving the joystick left, right, up, or down.

### Basic functions



#### **Power On**

When the projector is turned off, place your finger on the joystick button, press it once, and release it.



#### **Power Off (Press and Hold)**

Press and hold the joystick button for more than 3 seconds while the projector is on.



#### **Volume Control**

Place your finger over the joystick button and move it left or right, you can adjust the volume level.



#### **Up/Down/ Left/Right**

If you move the joystick up, down, left, or right, you can move the cursor to select the menu items.





### **! NOTE**

- When moving the joystick button up, down, left or right, be careful not to move the button while it is being pressed. The volume may not be adjusted and the cursor may not move when the joystick button is pressed and moved.

## **Adjusting the menu**

When the projector is turned on, press the joystick button one time.

You can adjust the menu items (🔌, 📺, ✕, ⚙️) moving the joystick button left, right, up, or down. Move to the desired menu item, and then press the joystick button once to select it.

-  Turns the power off.
-  Changes the input source.
-  Clears on-screen displays and returns to projector viewing.
-  Displays the Settings menu.

## Projector Status Indicators

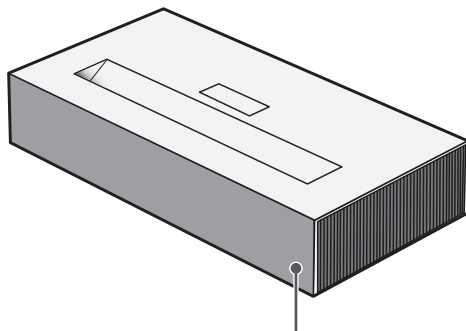

LED Power Indicator

| LED Power Indicator |   |
|---------------------|---|
| <b>Red</b>          | Power standby state                           |
| <b>Off</b>          | The projector is operating with the power on. |

# INSTALLATION

## How to use the edge guards

It prevents any damage to the product and injury when being attached to sharp edges of the product.

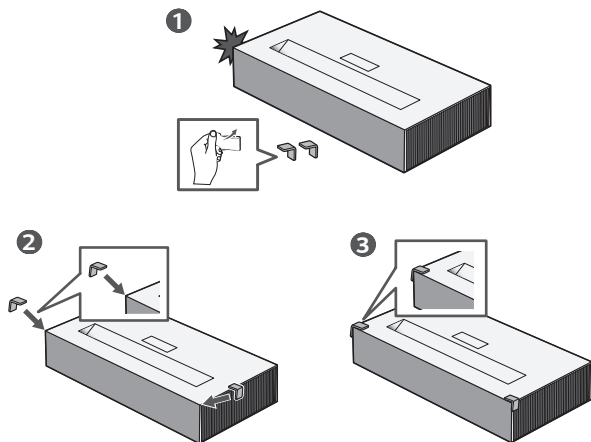



## Projection Distance per Screen Size

- 1** Place the projector on a sturdy, level surface, together with the PC or audio/video source.
- 2** Place the projector an appropriate distance away from the screen. The distance between the projector and the screen determines the actual size of the image.
- 3** Position the projector so that the lens is at a right angle to the screen. If the projector is not at a right angle, the projected image will look distorted. To correct the distortion, use the Edge Adjustment function.
- 4** Connect the power cord of the projector and the connected device to the wall outlet.

## Ratio of upward projection: 120 %

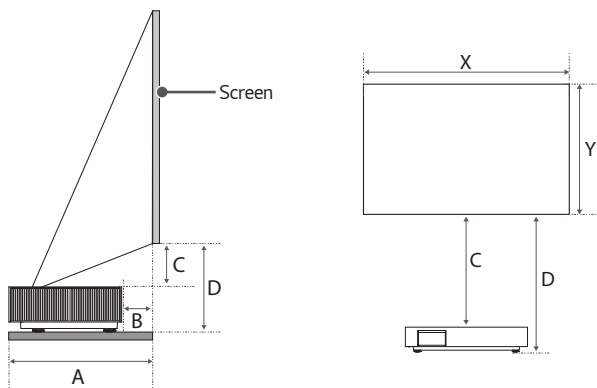

| Screen Size |      | Horizontal Size (X) x<br>Vertical Size (Y) | A   | B   | C   | D   |
|-------------|------|--|-----|-----|-----|-----|
| inches      | mm   | mm   | mm  | mm  | mm  | mm  |
| 90          | 2286 | 1992 x 1121                                | 403 | 56  | 182 | 321 |
| 95          | 2413 | 2103 x 1183                                | 424 | 77  | 195 | 334 |
| 100         | 2540 | 2214 x 1245                                | 445 | 98  | 207 | 346 |
| 105         | 2667 | 2324 x 1308                                | 466 | 119 | 220 | 358 |
| 110         | 2794 | 2435 x 1370                                | 488 | 141 | 232 | 371 |
| 115         | 2921 | 2546 x 1432                                | 509 | 162 | 245 | 383 |
| 120         | 3048 | 2657 x 1494                                | 530 | 183 | 257 | 396 |

The projection distance may vary depending on the installation conditions.

**NOTE**

- If the projected image looks distorted or bent, check to see if the screen is installed properly.

## Focus of the Screen Image

When an image appears on the screen, check if it is in focus and fits the screen properly.

**1** Press  (**Edge Adjustment**) button on the remote control to execute the [Edge Adjustment] function.

**2** Move the projector to the left or right to check that the projection fits on the screen.

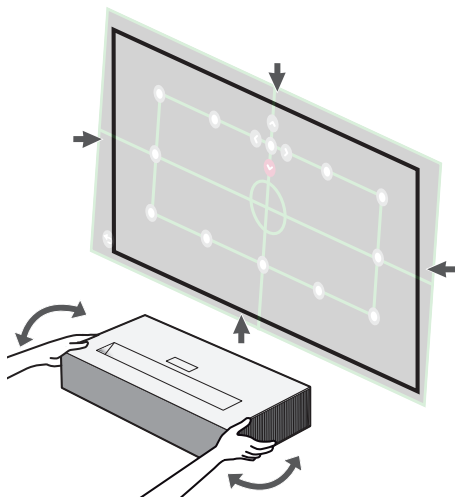

**3** To adjust the focus of the image, slowly adjust the focus ring to the left or right while looking at the top center of the screen. You can adjust the focus most effectively when the left and right screen are balanced. When adjusting the focus on the screen, do not let the product shake.

- Before using the focus ring, press the lower left corner of the focus ring cover once to open the cover. Please open the focus ring cover before using the focus ring.

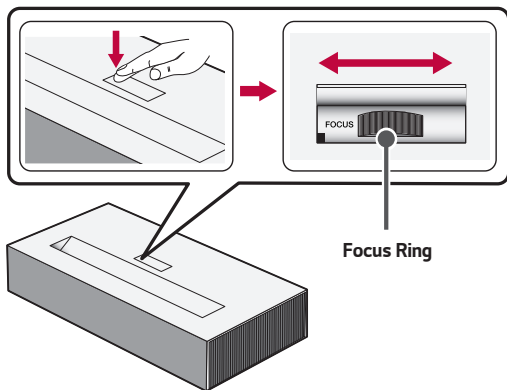

**4** If the angle of the projection is not perpendicular, use the [Edge Adjustment] function. (Use the Up/Down/Left/Right buttons on the remote control to adjust the top/bottom/left/right of each angular point.)

## Kensington Security System

- This projector has a Kensington Security Standard connector as an anti-theft mechanism. Connect a Kensington Security System cable as shown below.
- For more information on installation and use of the Kensington Security System, refer to the user's guide provided with the Kensington Security System.
- The Kensington Security System is an optional accessory.
- What is Kensington?

Kensington is a company that provides safety systems for laptops and other electronic devices. Website: <http://www.kensington.com>

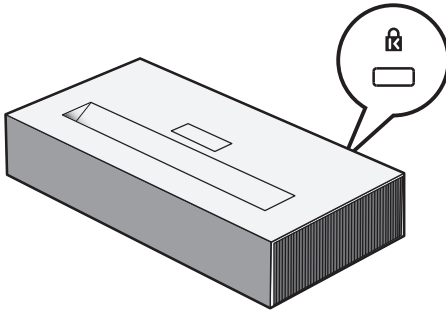

# MAGIC LIGHTING REMOTE

If the battery low message appears while using the Projector, replace the batteries.

As shown in the figure, press the top of the battery cover and slide it down the cover. Insert two new and identical batteries (1.5 V, AA type) with + and - poles pointing in the correct direction in the remote control.

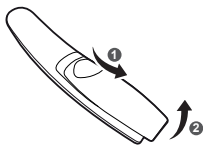

**\* : To use the button, press and hold for more than 3 seconds.**

## ⚠ CAUTION

- Do not mix new batteries with old ones.

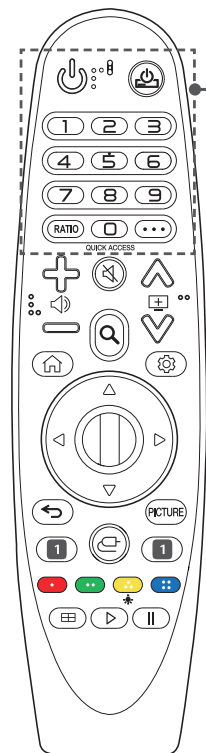

### ⏻ (POWER)

Turns the Projector on or off.



You can turn your set-top box on or off by adding the set-top box to the universal remote control for your Projector.

### Number buttons

Enters numbers.



Accesses the [QUICK HELP].

### RATIO

Changes the aspect ratio of the screen per pressing of the button.

### QUICK ACCESS \*

Edits QUICK ACCESS.

(QUICK ACCESS is a feature that allows you to enter a specified app directly by pressing and holding the number buttons.)

### ... (MORE ACTIONS)

Displays more remote control functions.

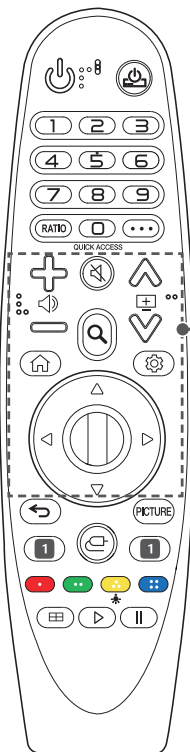

Adjusts the volume level.



**(MUTE)**

Mutes all sounds.



**(MUTE) \***

Accesses the [Accessibility] menu.



**(Search)**

Search for content such as movies and other videos, or perform a web search by entering your search terms in the search box.



Moves to the previous/next page.



Accesses the Home menu.



Displays the list used previously.



**(Q. Settings)**

Accesses the Quick Settings.



**(Q. Settings) \***

Displays the [All Settings] menu.



**(Up/Down/Left/Right)**

Press the up, down, left or right button to scroll the menu. If you press  $\triangle$   $\nabla$   $\triangleleft$   $\triangleright$  buttons while the pointer is in use, the pointer will disappear from the screen and the Magic Lighting Remote will operate like a general remote control. To display the pointer on the screen again, shake the Magic Lighting Remote to the left and right.



**Wheel (OK)**

Press the center of the Wheel button to select a menu. You can change pages by using the Wheel button.

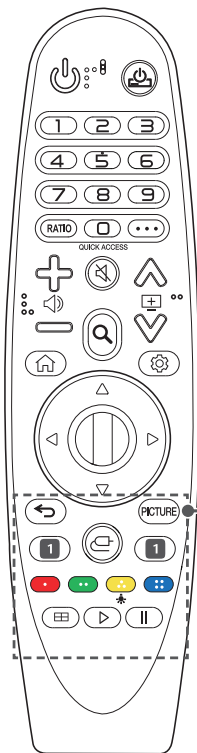
**(Back)**

Returns to the previous screen.

**(Back) \***

Clears on-screen displays and returns to last input viewing.

**PICTURE**

Changes the picture mode.

**1 Streaming Service buttons**

Connects to the Video Streaming Service.

**(INPUT)**

Changes the input source.

**(INPUT) \***

Accesses the [Home Dashboard].



These access special functions in some menus.



The remote control buttons light up so that you can use the remote control in the dark.

If the remote control does not move, the pointer disappears and the remote control light turns off in about 5 seconds.

The lighting function is applied when the product is shipped, and if you press and hold the  button for more than 5 seconds, the **(POWER)** button flashes twice and you can turn the lighting function on or off.**(Edge Adjustment)**

Execute [Edge Adjustment].

**Control buttons**

Controls media contents.





## To Register the Magic Lighting Remote

You must pair the Magic Lighting Remote with the projector to use it.

Pair the Magic Lighting Remote prior to use as follows.

- 1 Put batteries into the Magic Lighting Remote and turn the Projector on.
  - 2 Point the Magic Lighting Remote at your projector and press the  **Wheel (OK)** on the remote control.
- If the projector fails to register the Magic Lighting Remote, try again after turning the projector off and back on.

## To Re-register the Magic Lighting Remote

- 1 Press the  and  buttons at the same time, for five seconds, to unpair the Magic Lighting Remote with your projector.
  - 2 Press the  **Wheel (OK)** button towards the projector to re-register the Magic Lighting Remote.
- Pressing and holding the **PICTURE** button will let you cancel and re-register Magic Lighting Remote at once.

## Using the Magic Lighting Remote

- If you shake the Magic Lighting Remote left and right or turn its wheel while pointing it at the projector, a pointer will appear on the projector screen. If you move the remote control in the direction you want, the pointer follows the movement.

Move the pointer to the location you want and press the **Wheel (OK)** button to execute the function.

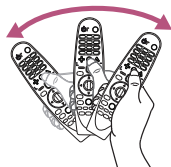
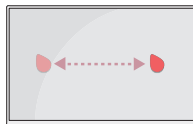

### Setting the Pointer of Magic Lighting Remote

 →  → [Accessibility] → [Pointer Options]

- You can set the pointer speed and size you want while it is on the screen.
  - [Tracking Speed]: Sets the pointer speed.
  - [Pointer Size]: Selects the pointer size.
- If the pointer has not been used for a certain period of time, it will disappear. When the pointer disappears from the screen, shake the Magic Lighting Remote right and left.  
The pointer will disappear if you press the up, down, left, right buttons, and the remote will work as a conventional remote.
- If the pointer is not responding smoothly, you can reset the pointer by moving it to the edge of the screen.
- Use the remote control within the specified range (within 10 m). You may experience communication failures when using the device outside the coverage area or if there are obstacles within the coverage area.
- You may experience communication failures depending on the accessories. Devices such as a microwave oven and wireless LAN operate in the same frequency band (2.4 GHz) as the Magic Lighting Remote. This may cause communication failures.
- Impacts can cause the Magic Lighting Remote to malfunction.
- Take care not to bump into nearby furniture, electronic equipment, or other people when using the Magic Lighting Remote.

# CONNECTING DEVICES

You can connect various external devices to the projector.

## Connecting with a HDMI Cable

Various functions are available after connecting a DVD, PC, laptop, etc. with an HDMI cable.

With an HDMI cable, you can enjoy high quality picture and sound.

Using a HDMI cable, connect the **HDMI** port of the projector to the HDMI output port of the device to connect. Both video and audio are output at the same time.

-  (**INPUT**) → [Home Dashboard] → [INPUTS] → [HDMI1]/[HDMI2]

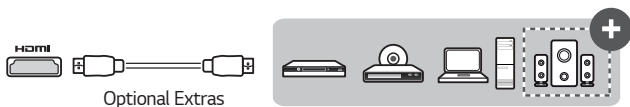

### **NOTE**

#### **ARC (Audio Return Channel)**

- External audio devices that support SIMPLINK and ARC must be connected using **HDMI1 ARC** port. ()
- When connected with a high-speed HDMI® cable, external audio devices that support ARC output or SPDIF work with the SIMPLINK function without the need for an additional optical audio cable.

#### **When connecting PC/laptop**

- The projector supports Plug and Play. Your PC will automatically detect the projector and requires no driver installation.

## Connecting with a USB-C Cable

Connect the USB-C terminal of the projector to the USB-C output terminal of a PC/laptop or smartphone using a USB-C cable.

Contact the manufacturer of your device to see if this feature is supported. Only the smartphones that support USB-C will work.

-  (**INPUT**) → [Home Dashboard] → [INPUTS] → [USB-C]

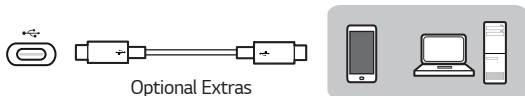

### **NOTE**

- PD (Power Delivery) and DP Alternate Mode are supported.
  - A USB-C gender changer may be necessary depending on the cable used if using PD (Power Delivery).
- The function may not operate properly depending on the connected device's specifications, USB-C cable status, or surroundings.
- The USB PD (for power supply) function may not operate according to the specifications of the connected equipment.
- Check the resolution of the connected devices before using the DP Alternate Mode function.

## Connecting a Digital Amp

Using an optical cable, connect the digital audio input port of a digital amp to the **OPTICAL DIGITAL AUDIO OUT** port of the projector. The output of an amp with a digital converter must be set to the desired audio format. When using a HDMI cable to connect a home theater or when connecting an optical output to an external audio device, set [Sound Out] to [Optical]. If a projector, home theater, or the speaker of an external audio device is operating at the same time, there will be an echo.

OPTICAL DIGITAL  
AUDIO OUT



Optional Extras

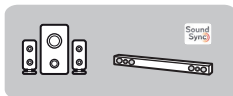

### ! NOTE

- Refer to the user manual of the audio device to connect.
- When connecting this product to other devices, make sure to turn off and unplug all the devices.
- The audio output of this product has wide-ranging audio bandwidth, so the receiver volume must be adjusted properly. Speakers can be damaged by unexpected high frequencies.
- Connecting the **OPTICAL DIGITAL AUDIO OUT** port of the projector to the digital audio input port of a digital amp and the audio input port of the projector to the analog audio output port of the digital amp can cause sound oscillation due to the closed loop. Remove one of the two connections to prevent this. (This also applies to home theater devices.)

## Connecting a smart device (smartphone, tablet, etc.)

☰ (INPUT) → [Home Dashboard] → [INPUTS] → [HDMI1]/[HDMI2]

- The picture may look different from the actual product.

Connect a smart device to the projector using a cable<sup>1)</sup> and set the external input of the projector to HDMI. The smart device screen will then be displayed through the projector. You can connect with any HDMI input port.

For model-specific instructions regarding use of the wired connection, please check with the smart device manufacturer.

Supported smart devices may change depending on the circumstances of each manufacturer.

1) Examples of how to connect a cable to different smart devices (cable purchased separately).

### Slimport supported devices

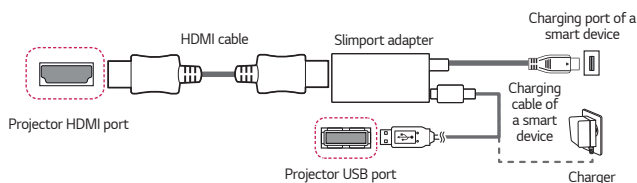

### Apple Lightning Digital AV adapter supported devices

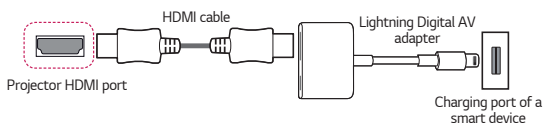

### Apple 30-pin Digital AV adapter supported devices

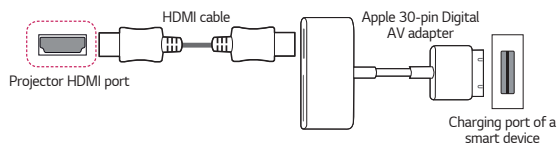

# SPECIFICATIONS

| MODEL  | HU85LS (HU85LS-EU)   |                           |
|--|--|---------------------------|
| <b>Resolution (Pixel)</b>                          | 3840 (Horizontal) × 2160 (Vertical) <sup>1)</sup>                  |                           |
| <b>Aspect ratio</b>                                | 16:9 (Horizontal:Vertical)   |                           |
| <b>Projection distance</b><br>– <b>Screen size</b> | 403 mm to 530 mm<br>– 2286 mm to 3048 mm (90 inches to 120 inches) |                           |
| <b>Ratio of upward projection</b>                  | 120 %  |                           |
| <b>Power consumption</b>                           | 350 W  |                           |
| <b>Power</b>                                       | AC 100 - 240 V, 50/60 Hz, 3.5 A                                    |                           |
| <b>Audio Output</b>                                | 5 W + 5 W  |                           |
| <b>Height</b>                                      | 128 mm (without foot), 139 mm (with foot)                          |                           |
| <b>Width</b>                                       | 680 mm   |                           |
| <b>Depth</b>                                       | 347 mm   |                           |
| <b>Weight</b>                                      | 12.2 kg  |                           |
| <b>USB Device</b>                                  | <b>USB 2.0 Standard-A</b>  | Output: 5 V, 0.5 A (Max.) |
|  | <b>USB Type-C</b>  | Output: 5 V, 1 A (Max.)   |
| <b>Environment Condition</b>                       | <b>Temperature</b>   |                           |
|  | <b>Operation</b>   | 0 °C to 40 °C             |
|  | <b>Storage</b>   | -20 °C to 60 °C           |
|  | <b>Relative Humidity</b>   |                           |
|  | <b>Operation</b>   | 0 % to 80 %               |
|  | <b>Storage</b>   | 0 % to 85 %               |

- Contents in this manual may be changed without prior notice due to upgrade of product functions.

1) 4K UHD resolution with 8.3 million discrete pixels projected by XPR (Expanded Pixel Resolution) video processing.



## HDMI (DTV) / USB-C (DTV) Supported Mode

| Resolution   | Horizontal Frequency (kHz) | Vertical Frequency (Hz) |
|--------------|----------------------------|-------------------------|
| 640 x 480    | 31.46                      | 59.94                   |
| 640 x 480    | 31.5                       | 60.00                   |
| 720 x 480    | 31.47                      | 59.94                   |
| 720 x 480    | 31.5                       | 60.00                   |
| 720 x 576    | 31.25                      | 50.00                   |
| 1280 x 720   | 44.96                      | 59.94                   |
| 1280 x 720   | 45                         | 60.00                   |
| 1280 x 720   | 37.5                       | 50.00                   |
| 1920 x 1080i | 28.12                      | 50.00                   |
| 1920 x 1080i | 33.72                      | 59.94                   |
| 1920 x 1080i | 33.75                      | 60.00                   |
| 1920 x 1080p | 26.97                      | 23.97                   |
| 1920 x 1080p | 27.00                      | 24.00                   |
| 1920 x 1080p | 33.71                      | 29.97                   |
| 1920 x 1080p | 33.75                      | 30.00                   |
| 1920 x 1080p | 56.25                      | 50.00                   |
| 1920 x 1080p | 67.43                      | 59.94                   |
| 1920 x 1080p | 67.5                       | 60.00                   |
| 1920 x 1080p | 112.5                      | 100                     |
| 1920 x 1080p | 134.86                     | 119.88                  |
| 1920 x 1080p | 135.00                     | 120                     |

| <b>Resolution</b> | <b>Horizontal Frequency (kHz)</b> | <b>Vertical Frequency (Hz)</b> |
|-------------------|-----------------------------------|--------------------------------|
| 3840 x 2160p      | 53.95                             | 23.98                          |
| 3840 x 2160p      | 54                                | 24.00                          |
| 3840 x 2160p      | 56.25                             | 25.00                          |
| 3840 x 2160p      | 61.43                             | 29.97                          |
| 3840 x 2160p      | 67.5                              | 30.00                          |
| 3840 x 2160p      | 112.5                             | 50.00                          |
| 3840 x 2160p      | 134.86                            | 59.94                          |
| 3840 x 2160p      | 135                               | 60.00                          |
| 4096 x 2160p      | 53.95                             | 23.98                          |
| 4096 x 2160p      | 54                                | 24.00                          |
| 4096 x 2160       | 56.25                             | 25.00                          |
| 4096 x 2160       | 61.43                             | 29.97                          |
| 4096 x 2160       | 67.5                              | 30.00                          |
| 4096 x 2160       | 112.5                             | 50.00                          |
| 4096 x 2160       | 134.86                            | 59.94                          |
| 4096 x 2160       | 135                               | 60.00                          |

## HDMI (PC) / USB-C (PC) Supported Mode

| Resolution  | Horizontal Frequency (kHz) | Vertical Frequency (Hz) |
|-------------|----------------------------|-------------------------|
| 640 x 350   | 31.46                      | 70.09                   |
| 720 x 400   | 31.46                      | 70.08                   |
| 640 x 480   | 31.46                      | 59.94                   |
| 800 x 600   | 37.87                      | 60.31                   |
| 1024 x 768  | 48.36                      | 60.00                   |
| 1360 x 768  | 47.71                      | 60.01                   |
| 1152 x 864  | 54.34                      | 60.05                   |
| 1280 x 1024 | 63.98                      | 60.02                   |
| 1920 x 1080 | 67.5                       | 60                      |
| 1920 x 1080 | 135                        | 120                     |
| 3840 x 2160 | 54                         | 24.00                   |
| 3840 x 2160 | 56.25                      | 25.00                   |
| 3840 x 2160 | 67.5                       | 30.00                   |
| 4096 x 2160 | 53.95                      | 23.97                   |
| 4096 x 2160 | 54                         | 24                      |

- If an invalid signal is input into the projector, it will not be displayed properly on the screen or a message such as [No Signal] or [Invalid Format] will be displayed.
- The projector supports the DDC1/2B type as the Plug and Play function (Auto-recognition of PC monitor).
- 3840 x 2160 is recommended as the best picture quality in the PC mode.







## Other specifications

**Risk Group 2**

**CAUTION** Possibly hazardous optical radiation emitted from this product. Do not stare at operating lamp. May be harmful to the eye.

This label is attached to the bottom of the product and language may differ.

# SYMBOLS

|   |                                     |
|---|-------------------------------------|
|  | Refers to alternating current (AC). |
|  | Refers to direct current (DC).      |
|  | Refers to class II equipment.       |
|  | Refers to stand-by.                 |
|  | Refers to "ON" (power).             |
|  | Refers to dangerous voltage.        |

# TROUBLESHOOTING

Please check the list below when you experience the following symptoms during use of the product. It may not be a failure.

## Checklist for Safety (please check a long-used projector for safety issues.)

Does your device have any of the following issues?

- The projector does not display anything on the screen or output sound when it is turned on.
- The product emits smoke or a burning smell.
- Water or foreign substances are present inside the product.
- Part of the projected image is cut out.
- A strange noise (crackling or sparking sound) regularly occurs from inside the projector.
- The projector still displays the screen or outputs sound when it is turned off.
- There are other errors or failures.

In this case, stop using the product.

- For safety, turn off the power switch and remove the plug from the socket.
- Contact the place of purchase or authorized service center for product inspection.
- Do not attempt to repair the product yourself.

## Abnormal behavior

- There is a coloured dot (bright dots, dark dots, stationary dots, and/or flickering dots) on the screen.
  - This projector was produced with high precision technology. However, a tiny dark or bright dot may appear on the screen. This is a common occurrence due to the production process, and it does not indicate a functional failure.
- The remote control may not work properly where a lamp with electronic stabilizer or a three-wavelength lamp is installed.
  - In this case, replace the lamp with electronic stabilizer or the three-wavelength lamp with international standard products to ensure the remote control works properly.





# ABOUT LG PROJECTOR

---

Image shown may differ from your projector.

Your projector's OSD (On Screen Display) may differ slightly from that shown in this manual.

[ ] : the buttons and the text to be displayed on the projector screen.



# CONTENTS

|                                       |           |
|---------------------------------------|-----------|
| <b>ABOUT LG PROJECTOR</b>             | <b>3</b>  |
| <b>HOW TO OPERATE THE PROJECTOR</b>   | <b>9</b>  |
| <b>HOW TO USE VARIETY OF CONTENTS</b> | <b>17</b> |
| <b>CONNECT OTHER DEVICES</b>          | <b>23</b> |
| <b>BENEFITS OF SMART PROJECTOR</b>    | <b>52</b> |
| <b>TOUR LIST OF SETTINGS</b>          | <b>56</b> |
| <b>TO UPDATE SOFTWARE</b>             | <b>86</b> |
| <b>TROUBLESHOOTING</b>                | <b>87</b> |

# ABOUT LG PROJECTOR

## Home Tutorial

### Using the Home feature of the LG Projector

You can open the Home screen by pressing the  button on your remote control. You can combine frequently used apps on a single screen and use whichever you want at any time.

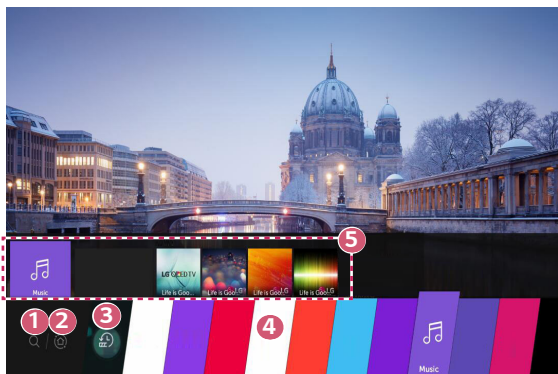

- 1 Launch [Search].
- 2 Move to the [Home Dashboard].  
You can select or control a device (mobile, external device, etc.) connected to the projector.

3 Move to the recently used app.  
Long-press the  button on the remote control or focus the [Recents].  
You can run or close a recently used app in the list provided in the preview area at the top.

4 You can run, move, and delete all the apps installed on your projector.







5 Focus on each App area. It provides the preview at the top.  
You can check or run useful features of each app and recommended content on the preview without entering into the app.

- Some apps may not provide the preview.

- The availability of and access to contents and services in LGE device are subject to change at any time without prior notice.

## Manage LG Projector Home

You can view a list of all apps installed on your projector, change their positions, or delete them.

- 1** Select the app you want to edit, and press and hold the  **Wheel (OK)** or  **OK** button on the Remote Control. This will activate the app edit mode.  
Or you can select the edit mode button at the far right corner of the Home list to enter the app edit mode.
- 2** To move the app to your desired position, go to the position and press the  **Wheel (OK)** or  **OK** button. To delete an app, select the **X** above the app.
  - You can move and delete as many apps as you wish before exiting the edit mode.
  - You can also move apps with the /  buttons on your remote control.
- 3** After the editing is done, press the **X** at the top right to exit the app edit mode.
  - The default projector app cannot be edited.

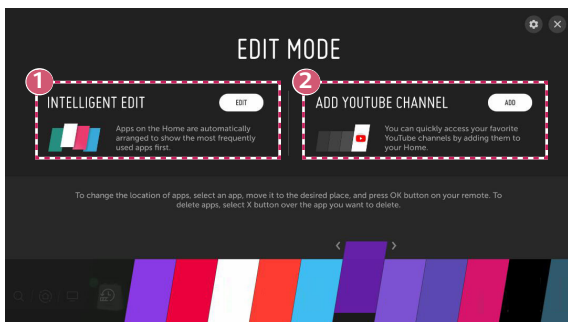



- 1 You can automatically arrange the app list in the order of most frequently used based on your accumulated app usage pattern.
- 2 You can add your favourite video service channel to the list.
  - This feature is available only when the network is connected.
  - Some models may not be supported.

# Network Setting



## Network Setting

If you configure settings for the network, you can use various services such as online contents and applications.

### Setting a Wired Network

- 1 Connect the LAN port of the projector and the router using a LAN cable. The router should be connected to the Internet beforehand.
- 2 Press the  (**Q. Settings**) button on the remote control and select  → [Connection] → [Wired Connection (Ethernet)].
  - If the router supports DHCP, the projector is automatically connected to the network when you connect the projector to the network with a LAN cable.

### Setting a Wireless Network

- 1 Turn on the power of the router connected to the Internet.
- 2 Press the  (**Q. Settings**) button on the remote control and select  → [Connection] → [Wi-Fi Connection].
- 3 When the network search is complete, the list of networks available for connection is shown.
- 4 Select a network to connect. If your Wireless Router is password protected, enter the password configured for the router.

**Network Setting Warnings**

- Use standard LAN cable (connect to Cat7 or higher with RJ45 connector, 10 Base-T, or 100 Base TX LAN port).
- Resetting the modem may fix some network connection problems. Turn the power OFF, disconnect and reconnect it, and then turn the power on to solve the problem.
- LG Electronics is not responsible for any network connection problems or any faults, malfunctions, or errors caused by network connection.
- The network connection may not work properly because of network settings or the Internet service provider.
- DSL service must use a DSL modem; and cable service must use a cable modem. Since only a limited number of network connections may be available, projector network setting may not be used depending on the contract with Internet service provider. (If the contract does not allow more than one device per line, only the already-connected PC may be used.)
- A wireless network can experience interference from other devices that use the 2.4 GHz frequency (wireless phone, Bluetooth device, or microwave oven). Although interference can also happen when using the 5 GHz frequency, it is less likely to occur.
- The wireless environment can make wireless network service run slowly.
- Failure to turn off all local home networks may cause excessive traffic on some devices.
- The access point device must support wireless connections and wireless connection feature must be enabled on the device to have AP (access point) connection. Contact the service provider for availability of wireless connections on the access point.
- Check SSID and security settings of the AP. Refer to the appropriate documentation for SSID and security settings of the AP.
- Invalid settings of network devices (wired/wireless line sharer, hub) can cause the projector to operate slowly or not operate properly. Install the devices correctly according to the appropriate manual and network.
- The connection method may differ depending on the AP manufacturer.

# HOW TO OPERATE THE PROJECTOR

## To View More Features of the Remote Control

You can control more features or external devices connected to your projector by using the buttons displayed on your projector screen.

- 1 Press the **⋮** button on the remote control.
- 2 Using the remote control, select your desired button on [More Actions] displayed on your projector screen.

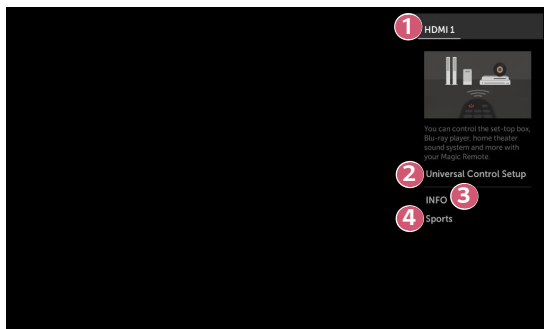

- 1 When you select a device, the [More Actions] turns into the remote control for the device.  
If a sound bar is connected, the [More Actions] can be used as a remote control for the sound bar.
  - You need Magic Lighting Remote to use universal remote control function.



- 2 With the Magic Lighting Remote, you can control Set-Top Boxes, Blu-ray Players, Home Theater systems, etc.
  - 3 It displays the information for the program you are watching, external input, photographs, music, video, etc. on the screen.
  - 4 You can set the video/sound mode for watching sports games.
- The types of buttons appearing on the [More Actions] vary, depending on the region and the type of connected device.
  - Some models may not be supported.

## Universal Remote Control

With the Magic Lighting Remote, you can control Set-Top Boxes, Blu-ray Players, Home Theater systems, etc.

### Automatically Setting the Universal Remote Control

Connect the devices to be set to the projector's HDMI input, and turn the power of the device on.

The projector will scan the connected device to automatically set the universal remote control without manual setting.

- After setting the universal remote control, you may need to do some additional user settings.
- It may take several seconds to complete the settings for the universal remote control.
- In some models, you can set the universal remote control only after converting to an input of a connected device.
- Depending on the connected device, the automatic setting feature for universal remote control (automatic device connection) may not be supported.

## Manually Setting the Universal Remote Control

If the universal remote control is not automatically set or it is connected to the AV input/Component input, you can manually set it.

**1** Select the  (**Q. Settings**) →  → [Connection] → [Device Connector].

**2** Select the type of the device you want to set.

**3** Complete the settings for the universal remote control according to the guidance on the screen.

You can change or cancel the universal remote control settings.

- This feature can only be used with the Magic Lighting Remote. (The provided remote control differ depending upon model.)
- Some models may not be supported.
- AV input/Component input ports are available in certain models only.
- When changing the settings, check that the device to be changed is turned on.
- You can set up the universal remote control with the latest updated information.
- The manual setting feature for universal remote control is not supported for a game console.
- Some buttons may not work depending upon the model of the external device.
- Place the device near the projector for seamless operation.
- If there is an obstacle in front of the device, it may not be able to receive the signal properly. If the device is in a drawer, open the drawer.

## Launching Apps through [QUICK ACCESS]

### Using apps quickly and easily with [QUICK ACCESS]

Press and hold a number button on the remote control to open an app or to activate an external input registered to the button.

#### Setting the [QUICK ACCESS]

- 1** Launch the app or input you wish to assign.
- 2** Press and hold the number button (1~8) you want to register.  
No. 9 is fixed to [QUICK HELP].
- 3** When the registration pop-up window appears, select [Yes].
  - If you press and hold a number button that has already been registered, the registered function will be performed.
  - To see the items that can be registered, select a number that has not been registered in the [EDIT QUICK ACCESS] mode.
  - If you are in a mode where [QUICK ACCESS] cannot run, no action will be performed.
  - If you delete a registered app, [QUICK ACCESS] will be deregistered as well.

### Checking and editing [QUICK ACCESS]





Press and hold the number 0 button on the remote control.  
The [QUICK ACCESS] edit screen appears.



- 1 Selecting a number that has already been registered allows deregistering it.
- 2 When you select a number that has not been registered, items that can be registered will be shown.
- 3 An item that has been registered to a different number is indicated with a check mark.
- 4 You can view a brief instruction for this function.

## Using SIMPLINK

You can conveniently control and use various multimedia devices connected through HDMI with the projector's remote control.

- 1** Connect the SIMPLINK HDMI Output port to the projector's HDMI IN port with an HDMI® cable.
- 2** Press the  (Q. Settings) button on the remote control and select  → [Connection] → [HDMI Device Settings].
- 3** Set [SIMPLINK (HDMI-CEC)] to [On].
- 4** Configure the [Auto Power Sync] settings to [On] or [Off]. (If [Auto Power Sync] is set to [On], turning on a SIMPLINK-linked device will turn the projector on. When you turn off the projector, the device will also be turned off.)
- 5** Turn on the connected device. When the projector automatically connects to the device, the input will switch. If the device is not automatically connected to the projector, click the  button.
  - This feature works only with devices with the  logo. Check for the SIMPLINK logo on the external device. There may be a problem using the device if the device does not meet the required specifications.
  - A high-speed HDMI® cable with CEC (Consumer Electronics Control) function is required to use SIMPLINK. Pin 13 of the high-speed HDMI® cable is used for data transfer between devices.
  - If you want to output sound to the external audio equipment connected through the HDMI® cable, set [SIMPLINK (HDMI-CEC)] to [On].

**Supported SIMPLINK Functions**

- **Instant Play**

When you start a multimedia device, you can immediately watch content from the device on the projector without having to control anything.

- **Controlling devices with the projector remote control**

Enables the user to control multimedia devices with the projector remote control to watch content.

- The pointer function of the Magic Lighting Remote can be limited.

- **Main Power Off**

If [Auto Power Sync] is set to [On] in the [HDMI Device Settings] settings and the projector is turned off, the devices connected to your projector via SIMPLINK will also be turned off.

- This feature is only available in certain devices.

- **Main Power On**

If [Auto Power Sync] is set to [On] in the [HDMI Device Settings] settings, turning on a SIMPLINK-linked device will turn the projector on.

- If [SIMPLINK (HDMI-CEC)] is set to [Off], [Auto Power Sync] cannot be set to [On].
- Some models may not be supported.

# HOW TO USE VARIETY OF CONTENTS

## LG Content Store

You can quickly and conveniently browse for TV Shows, Movies, and more to watch immediately.

You can also download and use apps from various categories such as education, entertainment, lifestyle, news, and games.

**1** Press the  button on the remote control.

**2** Launch the [LG Content Store] application.

- Depending on the model, the provided contents may differ or some features may be limited.
- Exercise caution when in used by children. Children may have access to inappropriate online content through this product.

You can block inappropriate online content by restricting access to some apps.

- Restrictions can be set in  (**Q. Settings**) →  → [Safety] → [Application Locks].

### Recommended Content on the Main Screen



You can view recommendations for the most popular content and apps in each category on the [LG Content Store] main screen. Choose a piece of content to watch it, or choose an app to download it.

- Some models may not be supported.
- This feature is available only when the network is connected.





## Creating LG Account

In [Account Management], you can use your email address to create a new LG account.

- 1** Press the  (**Q. Settings**) button on the remote control and select  → [General] → [Account Management].
- 2** Select [CREATE ACCOUNT]. Read and accept the Terms of Service.
- 3** Enter an ID and a password. Your ID must be your email address.
- 4** Enter your birthday.
- 5** Select [OK]. Go to your email to verify your email address. Please verify your email before the time expires.
- 6** Log in with your new account to start using the service.
  - Some models may not be supported.
  - Internet connection is required to create an account.
  - Required information may vary depending upon the country.
  - You may be restricted from the service depending upon your age.

## Managing your LG Account

You can manage the information of your LG account.

- 1 Press the  (**Q. Settings**) button on the remote control.
- 2 Go to  → [General] → [Account Management] to log in.

### Personal Information

You can view or edit your information of the account currently logged in.

You can change the password or press [EDIT] to edit your personal information.



- Some models may not be supported.

## Search Content

### [Search]

[Search] allows you to find and use a variety of content and information. You can search for files, including image, video, and audio files.

### Searching for Content

- 1 Press the  button on the remote control.
- 2 Launch .
- 3 Search for a variety of content and information by typing in your desired search terms.

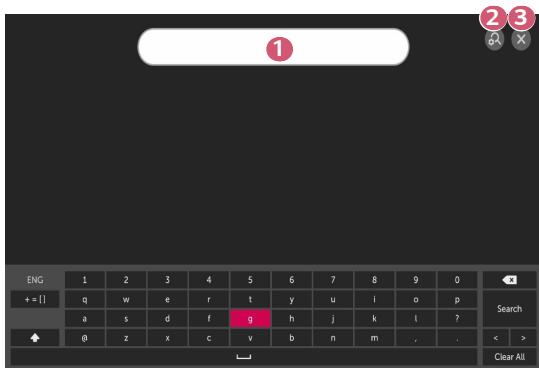

- 1 Enter your desired search term.
  - 2 Change the settings of the features provided by [Search].
  - 3 Exit the search.
- Some apps provide a feature that lets you search within your projector. If you run a search in such apps, the search will be carried out in [Search].
  - Search results may vary depending on the region, network settings, and whether you have agreed to the terms and conditions.

## Use App & Contents



### Installing Apps

You can install various apps on your projector from the [LG Content Store].

- 1** Press the  button on the remote control.
- 2** Launch the [LG Content Store] application.
- 3** Select your desired category from the categories shown at the top of the screen. The list of available apps in the selected category will be shown.
- 4** Select an app to set up from the list.
- 5** Read the details of the app and then press [Install].
- 6** When the installation is complete, you can run the app immediately.
  - Available categories may vary depending on the country or service status.
  - If the storage on your projector is insufficient, you can install the apps by connecting an external memory device.
  - Some USB storage devices may not be supported or may not work properly.
  - USB drivers containing apps from other LG TVs or LG Projectors may not be used.
  - You can delete apps you have downloaded in the [APPS] item's [My Apps].

## **Watching VOD Content**

You can immediately enjoy dramas, movies, and more with real-time streaming.

- 1** Press the  button on the remote control.
- 2** Launch the [LG Content Store] application.
- 3** Select your desired category from the categories shown at the top of the screen, such as TV Shows and Movies. The list of available content in the selected category will be shown.
- 4** Select an item from the list.
- 5** You can play your desired content.  
An app may be required to play the content. If not installed, install the app to play the content.
  - Some models may not be supported.
  - Available categories may vary depending on the country or service status.
  - To see detailed information about the content, select the title in the bottom and the  area.

# CONNECT OTHER DEVICES

## Using [Home Dashboard]

You can select or control a device (mobile, external device, Home IoT Devices, etc.) connected to the projector.

- Press and hold the  button on your remote control.

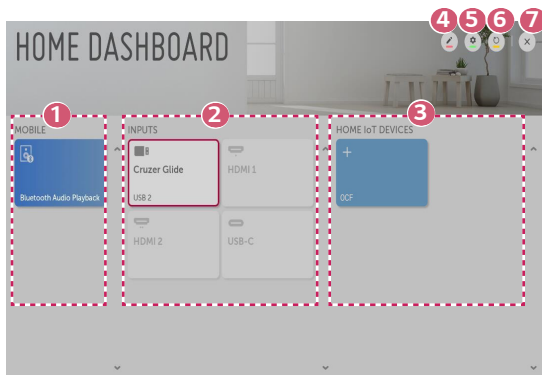

- 1 You can check and select the connected smart device with the LG TV Plus. You can play sound from a smart device connected via Bluetooth.
- 2 You can check and select the external device connected through the external input port or network.
- 3 You can check and control the device connected via the Home IoT.

- 4 You can edit the name or change the icon of a device connected to the Inputs.

You can edit the name of a device connected to the [HOME IoT DEVICES] or [SHOW]/[HIDE] the device.

- Some devices cannot be edited.

- 5 [OCF Connection]: If you set it to be [On], any device that supports OCF will be linked too.

[Notice]: If you turn it [On], you can receive notifications about the status of the Home IoT Devices.

[Device Connector]: You can start the [Device Connector] app.

- 6 It refreshes the device list.

- 7 Exit the [Home Dashboard].

- The configurable items differ depending upon model.

## Mobile Connection

You can use a variety of features by connecting the projector to a smart device.

### Connecting Your Smart Device to a Projector Using the LG TV Plus App

- 1** Download the LG TV Plus app from the app store of your smart device.
- 2** Connect your projector and smart device to the same Wi-Fi network.
- 3** Run the LG TV Plus app installed on your smart device.
- 4** Follow the instructions from LG TV Plus app to connect your smart device to the projector. You can check the connected smart device at [Home Dashboard] of the projector.



## Controlling Your Projector with the LG TV Plus App

You can tap the buttons on your smart device's screen to control the projector.

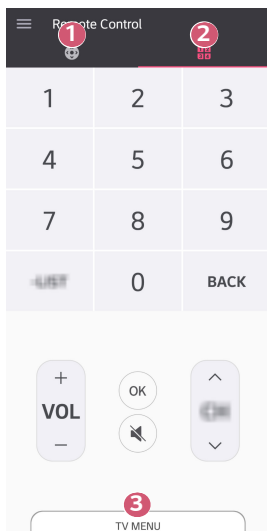

- 1 You can use the same functions as the Magic Lighting Remote's pointer and arrow keys.
  - 2 You can adjust the volume, or make other adjustments without using the remote control.
  - 3 You can open an app installed on your projector or configure settings for functions such as switching input.
- Some controls may be limited in external input mode.
  - The app's screen and functionality are subject to change without prior notice.
  - Available features may differ depending on your country and OS.

## **Share Content with the LG TV Plus App**

You can share and enjoy the content stored on your smart device through your projector.

- 1** Run the LG TV Plus app installed on your smart device.
- 2** Set up your desired content on your projector.

## **Matters That Require Special Attention during Content Share**

- Check your network settings if the Content Share option does not work properly.
- May not work properly on a wireless network. It is recommended that you connect to a wired network.
- May not work properly depending upon the network environment.
- If multiple display devices are connected to one device, the content may not be played properly depending upon server performance.
- Supported features may vary depending on the version and manufacturer of your smart device's operating system.
- To watch the 1080p video through Content Share function, a router that uses 5 GHz frequency is required.  
If a 2.4 GHz router is used, the video may not play properly.
- Captions are only supported on some connected devices.
- When a subtitle file is added later, disable the shared folder and then enable it again.
- The DRM files in the connected device will not play.
- Even for the file format supported by the projector, the supported file format may differ depending upon the connected device environment.
- If there are too many folders or files in a folder, it may not work properly.
- The information on the file imported from the connected device may not be displayed correctly.
- Depending upon the encoding, some streams may not play in Content Sharing mode.

## Share Smartphone Screen

### To see the Mobile Device's screen on the projector

- 1** Enable Screen Share mode on the mobile device.
  - 2** Your projector will be displayed in the list of available devices.
  - 3** Select your projector and request connection.
  - 4** After the connection is established, the projector will display the screen of the connected device.
- For a reliable connection always keep the connected device to your projector updated to the latest OS version.
  - A non-LGE device might not connect even when it is detected.
  - Connect the device to a 5 GHz router because the performance may be affected by your wireless environment.
  - The response rate may vary, depending upon the user's environment.
  - It differs among devices. For more information on the device you want to connect to, refer to its user guide.
  - If connection fails repeatedly, turn off the projector and the device you want to connect to, then turn them back on and try again.

## Playing Sound from a Smart Device through the projector's Speakers

Connect a smart device to the projector via Bluetooth to play sound from the smart device through the projector's speakers.

- 1** Press the  button on the remote control and select [Home Dashboard].
- 2** In the [MOBILE] area, run the [Bluetooth Audio Playback].
- 3** Turn the smart device's Bluetooth on, then select the projector from the list of devices.
- 4** The projector will be connected to the smart device.

## Connecting USB

Connect a USB storage device (USB HDD, USB Flash Drive) to the USB port on the projector to enjoy the content files stored on the USB storage device on your projector.

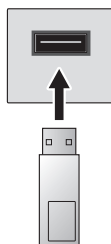

USB Flash Drive

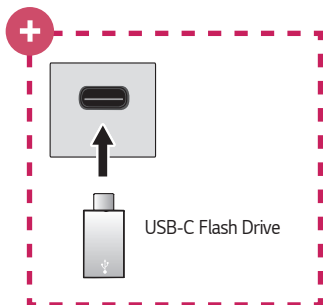





USB-C Flash Drive



### Models with USB-C support only.

- Please check whether USB 2.0 is supported before using USB-C storage devices.
- Certain functions may not work properly depending on USB-C to USB-A cable or gender used.

## Tips for Using a USB storage device

- A USB storage device that has a built-in automatic recognition program or uses its own driver might not be recognizable.
- Some USB storage devices may not be supported or may not work properly.
- If you use a USB extension cable, the USB storage device may not be recognized or may not work properly.
- Please use only USB storage devices formatted with the FAT32 or NTFS file system provided by Windows OS.
- It is recommended that you use an external USB HDD with a rated voltage of 5 V or less and a rated current of 500 mA or less.
- It is recommended that you use a USB hub or hard disk drive with a power supply. (If the power supplied is not sufficient, the USB storage device may not be detected properly.)
- It is recommended that you use a USB stick of 32 GB or less or a USB HDD of 2 TB or less.
- If a USB HDD with power-saving function does not work, turn the hard drive off and on again to make it work properly. See the owner's manual for the USB HDD for more information.
- Data on a USB storage device may be damaged, so it is recommended that you back up any important files. Users are responsible for data management. The manufacturer bears no responsibility.
- Press the  button on the remote control. To remove the USB storage device, press the Eject () button, which appears at the top when you focus on the USB storage device you want to remove. If you disconnect the USB storage device without selecting [EJECT], an error may occur in your projector or storage device.
- For more information on other connection methods, go to  (**Q. Settings**) →  → [Connection] → [Device Connector].
- Press and hold the  button on your remote control. Select the connected USB from [Home Dashboard] → [INPUTS] and select the [FORMAT] button to format the USB storage device. After format, all the data of USB storage device will be deleted and formatted as NTFS or FAT32 file system.
- When connecting a USB storage device, a random file/folder can be created to provide Smart projector services such as the saving and retrieving of thumbnail images.

## [Photo & Video]

### Viewing Photos and Videos

You can view photos and videos using the [Photo & Video] app.

- 1 Press the  button on your remote control.
- 2 Launch the [Photo & Video] application.
- 3 Select your desired storage device.
- 4 Select and view your desired photo or video.



- 1 Select your desired type of content and viewing method.
  - 2 Select and delete your desired content.  
(You cannot delete files that are shared from other devices.)
  - 3 Select the content you want to play. You can only select the same type of content as you first selected.
  - 4 Launch [Search].
- Certain content may not be displayed on the list if the number of all content exceeds 40,000.

## Photo Player

Selecting a photo in the [Photo & Video] app runs the photo player. You can view your saved photos.



- 1 Returns to the entire content list.
- 2 You can play background music by running the music player.
- 3 You can zoom the photos in/out.
- 4 Starts the slide show.
- 5 Rotates photos.
- 6 360-degree photos can be viewed in 360 degrees.
  - Using the 360° VR Play on a normal photo may distort the image.
  - Some models may not be supported.
- 7 You can set the size of a photo or change the speed and effect of a slide show.



## Supported Photo Files

| File type             | Format | Resolution  |
|-----------------------|--------|---|
| .jpeg<br>.jpg<br>.jpe | JPEG   | Minimum: 64 x 64<br>Maximum<br>Normal Type: 15360 (W) x 8640 (H)<br>Progressive Type: 1920 (W) x 1440 (H) |
| .png                  | PNG    | Minimum: 64 x 64<br>Maximum: 5760 (W) x 5760 (H)  |
| .bmp                  | BMP    | Minimum: 64 x 64<br>Maximum: 1920 (W) x 1080 (H)  |

## Video Player

Selecting a video in the [Photo & Video] app runs the video player. You can view your saved videos.

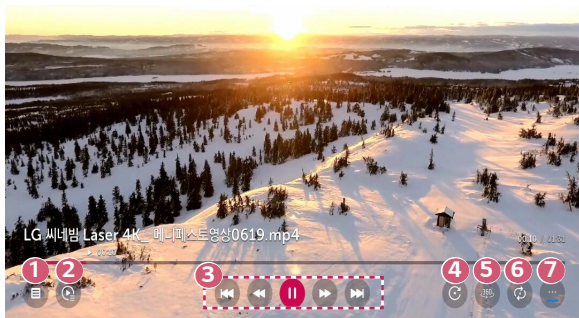

- 1 Returns to the entire content list.
- 2 You can select other content by displaying the playlist while watching a video.
- 3 You can control basic video playback functions.
- 4 Rotates videos.
  - Some models may not be supported.
- 5 360-degree videos can be viewed in 360 degrees.
  - Using the 360° VR Play on a normal video may distort the videos.
  - Some models may not be supported.
- 6 You can do the settings related to play on repeat of the video.
- 7 You can set additional options.

## Setting Additional Options

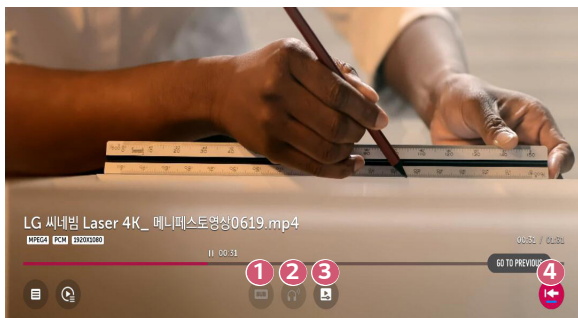

- 1 You can change subtitle settings.
- 2 You can set audio tracks.
- 3 You can set continue watching to resume playing from the last viewed scene.
- 4 Returns to the basic operation screen.

## Supported Video Files

### Maximum data transfer rate:

- Full HD video  
H.264 1920 x 1080@60P BP/MP/HP@L4.2 Maximum 40 Mbps  
HEVC 1920 x 1080@60P Main/Main10@L4.1 Maximum 40 Mbps
- ULTRA HD video (ULTRA HD model only)  
H.264 3840 x 2160@30P BP/MP/HP@L5.1 Maximum 50 Mbps  
HEVC 3840 x 2160@60P Main/Main10@L5.1 Maximum 60 Mbps

### Supported external subtitles:

\*.smi, \*.srt, \*.sub (MicroDVD, SubViewer 1.0/2.0), \*.ass, \*.ssa, \*.txt (TMPlayer), \*.psb (PowerDivX), \*.dcs (DLP Cinema)

### Supported embedded subtitles format:

- Matroska (mkv): Sub Station Alpha (SSA), Advanced Sub Station Alpha (ASS), SRT
- MP4 (mp4): Timed Text

## Supported video codecs

| Extension                  | Codec |   |
|----------------------------|-------|---|
| .asf<br>.wmv               | Video | VC-1 Advanced Profile (except for WMVA), VC-1 Simple and Main Profiles                              |
|                            | Audio | WMA Standard (except for WMA v1/ WMA Speech)  |
| .avi                       | Video | Xvid (except for 3 warp-point GMC), H.264/AVC, Motion Jpeg, MPEG-4                                  |
|                            | Audio | MPEG-1 Layer I, II, MPEG-1 Layer III (MP3), Dolby Digital, LPCM, ADPCM, DTS                         |
| .mp4<br>.m4v<br>.mov       | Video | H.264/AVC, MPEG-4, HEVC   |
|                            | Audio | Dolby Digital, Dolby Digital Plus, AAC, MPEG-1 Layer III (MP3), Dolby AC-4                          |
| .3gp<br>.3g2               | Video | H.264/AVC, MPEG-4   |
|                            | Audio | AAC, AMR-NB, AMR-WB   |
| .mkv                       | Video | MPEG-2, MPEG-4, H.264/AVC, VP8, VP9, HEVC   |
|                            | Audio | Dolby Digital, Dolby Digital Plus, AAC, PCM, DTS, MPEG-1 Layer I, II, MPEG-1 Layer III (MP3)        |
| .ts<br>.trp<br>.tp<br>.mts | Video | H.264/AVC, MPEG-2, HEVC   |
|                            | Audio | MPEG-1 Layer I, II, MPEG-1 Layer III (MP3), Dolby Digital, Dolby Digital Plus, AAC, PCM, Dolby AC-4 |
| .mpg<br>.mpeg<br>.dat      | Video | MPEG-1, MPEG-2  |
|                            | Audio | MPEG-1 Layer I, II, MPEG-1 Layer III (MP3)  |
| .vob                       | Video | MPEG-1, MPEG-2  |
|                            | Audio | Dolby Digital, MPEG-1 Layer I, II, DVD-LPCM   |

- Dolby AC-4: Some models may not be supported.

## **Cautions for Video Playback**

- Some user-created subtitles may not work properly.
- A video file and its subtitle file must be located in the same folder. For subtitles to be displayed properly, make sure that the video file and the subtitle file have the same name.
- Subtitles on a Network Attached Storage (NAS) device may not be supported depending on the manufacturer and model.
- Streams that include Global Motion Compensation (GMC) and Quarterpel Motion Estimation (Qpel) are not supported.
- ULTRA HD video (ULTRA HD model only): 3840 x 2160, 4096 x 2160  
Some HEVC-encoded ULTRA HD videos other than the content officially provided by LG Electronics may not be played.  
Some codecs can be supported after a software upgrade.

| <b>Extension</b>  | <b>Codec</b> |  |
|-------------------|--------------|--|
| <b>mkv/mp4/ts</b> | <b>Video</b> | H.264/AVC, HEVC                        |
|                   | <b>Audio</b> | Dolby Digital, Dolby Digital Plus, AAC |

- Only Window Media Audio V7 and later are supported.
- The AAC main profile is not supported.
- Video files created by some encoders may not be played.
- Video files in a different format than specified may not be played properly.
- Video files stored on a USB storage device that does not support High Speed may not be played properly.
- DTS codecs are supported only for playbacks of USB and HDMI video files.

## [Music]

### Playing Music

You can listen to music by using the [Music] app.

- 1 Press the  button on your remote control.
- 2 Launch the [Music] application.
- 3 Select your desired storage device.  
You can select your desired songs from all of your storage devices and add them to [My Playlist].
- 4 Select your desired music content and enjoy it.

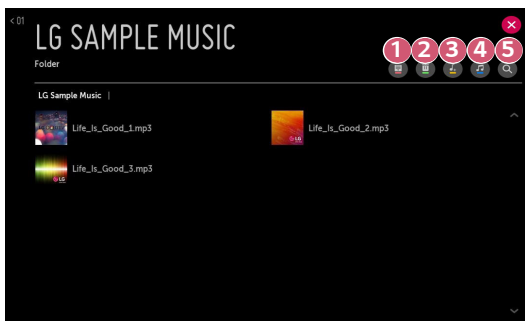



- 1 Select the desired type of content list.
  - 2 Select and delete content.  
(Files shared from other devices cannot be deleted.)
  - 3 Select content and add it to [My Playlist].
  - 4 Open the music player.
  - 5 Launch [SEARCH].
- If the number of all content is more than 5,000, some content may not be listed up.

## Using the Music Player

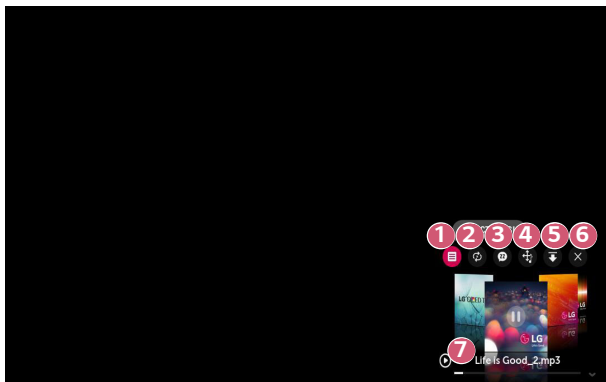
The music player lets you choose music from other apps and use it as background music.



- 1 You can play music from the selected storage device.
- 2 You can set repeat playback and random playback.
- 3 The configurable items differ depending upon model.
  -  : You can turn the screen off while listening to music or display the music player in full-screen mode.
  -  : You can listen to music with the screen turned off.



- 4 You can change the position of the music player.
  - 5 You can minimize the music player.
  - 6 This feature closes the music player.
  - 7 Lyrics are available for music files that provide them.  
In some music files, you can choose a lyric section and move the playback position.
    - The lyrics feature is only supported on some devices.
    - The lyrics may not be displayed in sync depending on the lyrics data in the music file.
- Reopen your music player by pressing the volume buttons on your remote control.
  - You may not be able to use the music player for some features.

## Audio Format

| File Format | Item         | Info                |
|-------------|--------------|---------------------|
| .mp3        | Bit rate     | 32 kbps ~ 320 kbps  |
|             | Sample freq. | 16 kHz ~ 48 kHz     |
|             | Support      | MPEG-1, MPEG-2      |
|             | Channels     | mono, stereo        |
| .wav        | Bit rate     | -                   |
|             | Sample freq. | 8 kHz ~ 96 kHz      |
|             | Support      | PCM                 |
|             | Channels     | mono, stereo        |
| .ogg        | Bit rate     | 64 kbps ~ 320 kbps  |
|             | Sample freq. | 8 kHz ~ 48 kHz      |
|             | Support      | Vorbis              |
|             | Channels     | mono, stereo        |
| .wma        | Bit rate     | 128 kbps ~ 320 kbps |
|             | Sample freq. | 8 kHz ~ 48 kHz      |
|             | Support      | WMA                 |
|             | Channels     | up to 6 ch          |
| .flac       | Bit rate     | -                   |
|             | Sample freq. | 8 kHz ~ 96 kHz      |
|             | Support      | FLAC                |
|             | Channels     | mono, stereo        |

- The number of supported channels may vary depending upon the sample frequency.

## [File Viewer]

### Viewing Files

You can see document files stored on a connected device.

- 1 Press the  button on your remote control.
- 2 Launch the [File Viewer] application.
- 3 Select your desired storage device.
- 4 Select and view your desired document file.

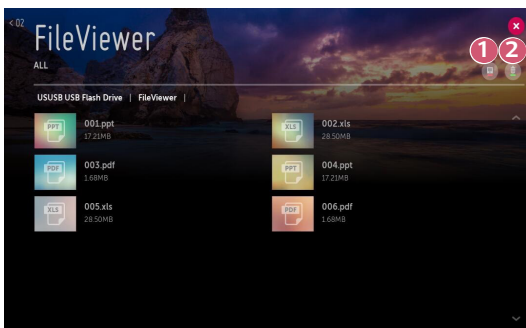

- 1 Select your desired type of content and viewing method.
  - 2 Select and delete your desired content.  
(You cannot delete files that are shared from other devices.)
- Certain content may not be displayed on the list if the number of all content exceeds 40,000.

## Browsing File Viewer

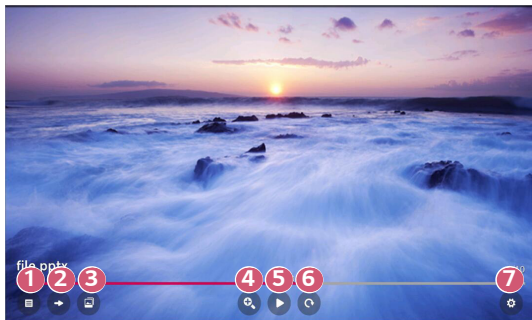

- 1 Returns to the entire content list.
- 2 Moves to the page you specify.
- 3 Sets the slide show.
- 4 Enlarges or reduces the document.
- 5 Starts the slide show.
- 6 Rotates the document.
- 7 Sets up the options of File Viewer.



## Supported File Formats

| File Extension | Supported Version  |
|----------------|--|
| XLS, XLSX      | Microsoft Office 97/2000/2002/2003/2007/2010/<br>2013/2016 version |
| DOC, DOCX      |  |
| PPT, PPTX      |  |
| TXT            | -  |
| PDF            | Adobe PDF 1.0/1.1/1.2/1.3/1.4 version                              |
| HWP            | Hangul 2007 version  |

- File Viewer realigns a document, so it may look different from what is displayed on a PC.
- For documents that include images, the resolution may look lower during the realigning process.
- If the document is large or has many pages, it may take longer to load.
- Unsupported fonts may be replaced by other fonts.
- The file viewer may not open for Office documents that contain many high resolution images. In that case, reduce the image file size, save it on a USB storage device and run the file viewer again or connect your PC to the projector and open the file on your PC.

## Using Home IoT Devices

You can check and control the status of the connected Home IoT devices.

- 1 Press the  button on the remote control and select [Home Dashboard].
- 2 Press the  at the top right to select the [OCF Connection].
  - To register your own OCF (Open Connectivity Foundation) supporting device, select the OCF guide to change the settings as directed.

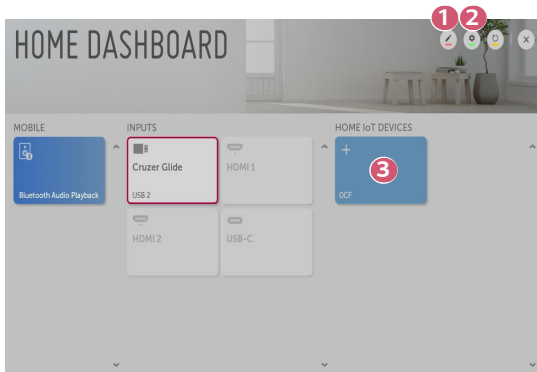

- 1 You can edit the name of a device connected to the [Home IoT Devices] or [SHOW]/[HIDE] the device.
  - 2 [OCF Connection]: If you set it to be [On], any device that supports OCF will be linked too.  
 [Notice]: If you turn it [On], you can receive notifications about the status of the Home IoT Devices.  
 [Device Connector]: You can start the [Device Connector] app.
  - 3 You can connect your own OCF (Open Connectivity Foundation) supporting device to the projector to use.
- Only some of the OCF (Open Connectivity Foundation) supporting device are supported, and we plan to continue to add support for more devices.
  - When resetting the projector, it also requires resetting the OCF (Open Connectivity Foundation) supporting device connected to the set.

## Share Computer Content

### What Is Content Share?

Content Share allows you to enjoy videos, music and photos saved on your PC.

#### Play the content with sharing software on the PC

If you have Windows 7 or later installed on your PC, you can play music, video, photos, etc. on your projector without needing to install a separate program.

- 1** Connect you projector and PC to the same network. PCs installed with Windows 7 or later also need to be connected to a network.
  - 2** Right-click the desired music/video/photo file you wish to play, then select your model using the “Play To” feature built into Windows 7 or later to play the file.  
To play on other devices like your mobile phone, refer to the relevant user guide.
- Even when multiple projectors or devices are connected, the selected file is played through only one device. The playback rate may vary depending on the network connection.

## Use the SmartShare PC Software to play the content saved on the PC

You can use SmartShare PC Software to connect the music/videos/photos saved on the PC to your home network and play them on your projector.

- 1** Configure the projector and PC installed with SmartShare on the same network.
  - The SmartShare service is only available when the projector and server PC are connected to a single router.
- 2** Download and install SmartShare PC Software from the LG website ([www.lg.com](http://www.lg.com)). Before installation, exit all programs running on the PC, such as a firewall or an anti-virus software.
- 3** Run SmartShare PC Software and configure the share settings.
- 4** Shared videos and photos are played from the [Photo & Video] app on the projector. Shared music files are played from the [Music] app on the projector.
  - The server should be running in order to watch the shared file on your projector.
  - For information on how to use the SmartShare PC Software, refer to the software's help section.



**Matters that require special attention during Content Share**

- Check your network settings if the Content Share option does not work properly.
- May not work properly on a wireless network. It is recommended that you connect to a wired network.
- If multiple display devices are connected to one device, the content may not be played properly depending on server performance.
- May not work properly depending on the network environment.
- To watch the 1080p video through Content Share function, a router that uses 5 GHz frequency is required.  
If a 2.4 GHz router is used, the video may not play properly.
- The Content Share function may not be supported for a router that does not support multi-cast. For more information, refer to the user guide that came with your router or contact the manufacturer.
- Captions are only supported on some connected devices.
- SmartShare PC Software is recommended for reading captions.
- When a subtitle file is added later, disable the shared folder and then enable it again.
- The DRM files in the connected device will not play.
- Even for the file format supported by the projector, the supported file format may differ depending on the connected device environment.
- If there are too many folders or files in a folder, it may not work properly.
- The information on the file imported from the connected device may not be displayed correctly.
- Depending upon the encoding, some streams may not play in Content Sharing mode.

# Share Computer Screen

## To see the PC screen on the projector

### Connect wireless

- 1 Enable Screen Share mode on the PC. Your projector will be displayed in the list of available devices.
  - 2 Select your projector and request connection.
  - 3 After the connection is established, the projector will display the screen of the connected device.
- Always update your device to be connected to your projector to the latest OS version for a reliable connection.
  - It is recommended that you use this function at close range.
  - Though it can be connected without a wireless router, connecting your device to a 5 GHz router is recommended because the performance can be affected by the surrounding wireless environment.
  - The response rate may vary, depending upon the user's environment.
  - It's different from Windows version. For more information on the device you want to connect to, refer to its user guide.
  - If connection fails repeatedly, turn off the projector and the device you want to connect to, then turn them back on and try again.

### Connect wired

Connect the PC with projector by HDMI® cable.

# BENEFITS OF SMART PROJECTOR

## Enjoying Internet

### Using the [Web Browser]

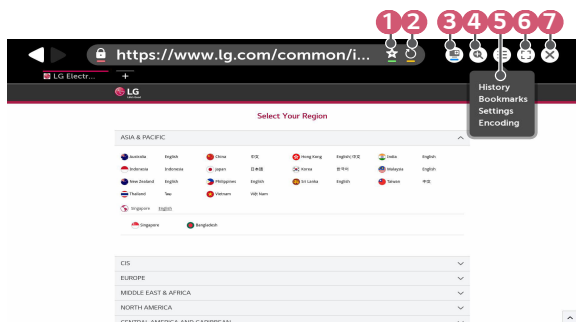

You can enter the website when you input the web address on the URL bar. If you input the search word, it will find the information about search word base on the search engine.

- 1 Press the  button on the remote control.
- 2 Launch the [Web Browser] application.



- 1 You can add or delete the current page in [Bookmarks].
- 2 Reloads the current page.
- 3 You can turn on/off Mini TV.
- 4 Zooms in or out of the screen.

- 5 [History]: You can open or delete the history list.  
[Bookmarks]: You can open or delete the bookmark list.  
[Settings]: You can configure simple settings for the browser.  
[Encoding]: You can change the language when the content is not properly displayed on the web page.
- 6 You can use the browser in full screen mode. To go back to the original screen, use the Remote Control to move the pointer to the top of the screen. [Exit Full Screen] will display.
- 7 Exit the [Web Browser].

- The [Web Browser] supports only HTML5 media, it does not support Flash Plug-in.
- The [Web Browser] does not support plug-in installation.
- On the [Web Browser], it may not be possible to play media files in formats other than JPEG/PNG/GIF
- The [Web Browser] may be closed if there is insufficient memory space.
- On the [Web Browser], only fonts embedded in the projector are used. Therefore, text may be displayed in different fonts than the ones on the PC.
- The [Web Browser] does not support file and font downloads.
- Since the [Web Browser] is a projector browser, it may function differently than PC browsers.
- Some of the content may not play properly.
- Exercise caution when in used by children. Children may have access to inappropriate online content through this product.  
You can block inappropriate online content by restricting access to some apps. Configure the settings in  (**Q. Settings**) →  → [Safety] → [Application Locks].

## Setting the Web Browser



Press  at the top of the screen and select the [Settings].

- [On Startup]  
You can set the startup page of the browser to [Open the New Tab page]/[Continue where I left off]/[Home page:].
- [Search Engines]  
You can select the default search engine.
  - Search engine settings may be subject to change without notice based on the supplier's circumstances.
- [Recommended Sites]  
You can change the settings so that [Recommended Sites] are displayed. The [Recommended Sites] and [Most Visited Sites] are displayed on a new tab. The [Recommended Sites] may not be available in your country. To hide the [Recommended Sites], choose [Off] in [Settings].
- [Always Show Bookmarks Bar]  
You can change the settings so that the [Bookmarks] bar is always displayed.
- [Private Browsing]  
You can configure the settings not to leave records after searching.
- [Site Filtering]  
To use the [Site Filtering] function, you should enter the projector password. The initial password is set as "0000".
  - [Approved Sites]: You can configure the settings to open the previously registered web pages only.
  - [Blocked Sites]: You can configure the settings to block specific websites.
- [Pop-up Blocker]  
You can block pop-ups using the settings.
- [Do Not Track]  
You can request your visit history not be recorded in the server.
- [Adaptive Streaming using JavaScript]  
If this is set to [Off], the resolution of the videos played in [Web Browser] is limited to 720p.

## [Notifications]

### Using [Notifications]

You can view all notifications from projector apps and LG service at the same time. You can view and delete each notification message, and directly move to the app or website using notifications that support shortcuts.

- 1 Press the  (**Q. Settings**) button on the remote control.
- 2 Go to  → [General] → [About This Projector] and select [Notifications].

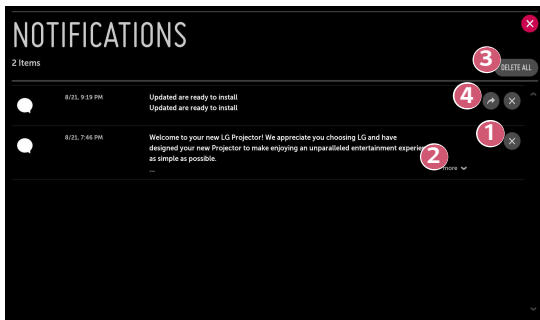

- 1 You can delete notifications.
- 2 For notifications with long content, press [more] to open them in full view.
- 3 You can delete all notifications.
- 4 You can launch the APP or move to URL.

# TOUR LIST OF SETTINGS

The options may differ depending on the model.

## Quick Settings

### To use Setting function quickly

Press the  (**Q. Settings**) button on the remote control.

Displays a set of light-weight controls quickly and simply such as [Picture Mode], [Aspect Ratio], [Sound Out] and so on.





- 1 Closes the Quick settings.
- 2 You can set the [Picture Mode].
- 3 You can set the [Aspect Ratio].
- 4 You can choose the [Sound Out].
- 5 You can set the [Sleep Timer].
- 6 You can set the [PJT Mode].
- 7 Move to the [Connection] screen.
- 8 You can set more options.

- Press and hold the  **Wheel (OK)** on the remote control during configuration to move to the corresponding menu.

## [Picture] Settings

### [Picture Mode]

 (Q. Settings) →  → [Picture] → [Picture Mode Settings] → [Picture Mode]

Select the picture mode that is best suited to your viewing environment, preferences or video type.

The configurable items differ depending upon model.

Depending upon the input signal, the available picture modes may be different.

When watching online service content, the Picture Mode may be changed to match the content being shown.

- [Vivid]  
Sharpens the image by increasing the contrast, brightness, and sharpness.
- [Standard]  
Displays the picture with normal contrast, brightness, and sharpness levels.
- [Cinema]  
Optimizes the screen for movies.
- [Sports]/[Cricket]  
Optimizes the screen for sports games. Sharpens the image of rapid movements such as kicking or throwing a ball.
  - The name of the sport may differ depending on region.
- [Game]  
Optimizes the screen for gameplay.
- [HDR Effect]  
This feature lets you enjoy a more dynamic, clearer image by correcting the light and dark areas of the display. This feature provides a realistic image, even when the source image's gradation level is high.  
If you set [Picture Mode] to [HDR Effect], you will not be able to use some of [Picture Mode Settings].
  - This feature is available on certain models only.
- [Expert (Bright Room)]/[Expert (Dark Room)]  
Allows an expert, or anyone who loves picture quality, to tune to the best picture quality.



**[Picture Mode Settings]**

 (Q. Settings) →  → [Picture] → [Picture Mode Settings]



This feature allows you to adjust the selected picture mode in detail.

Depending upon the input signal or the selected picture mode, the available options may differ.

The configurable items differ depending upon model.

- [Contrast]  
Adjusts the contrast of the bright and dark areas of the picture. The closer to 100, the higher the contrast.
- [Brightness]  
Adjusts the overall screen brightness. The closer to 100, the brighter the screen.
- [Sharpness]  
Adjusts the sharpness of the image. The closer to 50, the sharper and clearer the image.
- [Colour]  
Tones down or up the Colours displayed on the screen. The closer to 100, the deeper the Colour.
- [Tint]  
Adjusts the Colour balance between red and green displayed on the screen. The closer to Red 50, the more red the Colour will be. The closer to Green 50, the more green the Colour will be.
- [Colour Temperature]  
Adjusts the Colour temperature cool/medium/warm/natural.
  - The settings you specify only applies to the currently selected input mode.  
To apply your current picture settings to all input modes, select [Apply to All Inputs].
- [Apply to All Inputs]  
Save the current customized setting values to currently selected picture mode for all inputs.
- [Reset]  
This option will reset the picture settings.
  - You can reset the picture modes separately. Select the picture mode you wish to reset and enable it.

**[Advanced Controls]/[Expert Controls]**

 (Q. Settings) →  → [Picture] → [Picture Mode Settings] → [Advanced Controls]

Depending upon the input signal or the selected picture mode, the available options may differ.

The configurable items differ depending upon model.

- [Dynamic Contrast]  
Corrects the difference between the bright and dark areas of the screen for optimal results depending on the brightness of the picture.
- [Dynamic Colour]  
Adjusts the Colour and saturation of the picture to make the image more Colourful and lively.
- [Preferred Colour]  
Adjusts the Colours of skin, grass and sky to your personal preferences.
- [Colour Gamut]  
Selects the range of Colours to display.
- [Super Resolution]  
Adjusts the resolution to make dim and blurred images clearer.
- [Gamma]  
Adjusts the medium brightness of the picture.

 (Q. Settings) →  → [Picture] → [Picture Mode Settings] → [Expert Controls]

If you set the picture mode to Expert, you can set the following functions.

Depending upon the input signal or the selected picture mode, the available options may differ.

The configurable items differ depending upon model.

- [Dynamic Contrast]  
Corrects the difference between the bright and dark areas of the screen for optimal results depending on the brightness of the picture.
- [Super Resolution]  
Adjusts the resolution to make dim and blurred images clearer.
- [Colour Gamut]  
Selects the range of Colours to display.
- [Colour Filter]  
Filters a specific Colour spectrum in RGB Colours to fine-tune Colour saturation and hue accurately.
- [Gamma]  
Adjusts the medium brightness of the picture.
- [White Balance]  
Adjusts the overall Colour temperature of the screen as desired.
- [Colour Management System]  
This is used when experts control it by using a test pattern. You can control it by selecting areas of six Colours ([Red]/[Green]/[Blue]/[Cyan]/[Magenta]/[Yellow]). For normal images, adjustments may not result in noticeable Colour changes.

**[Picture Options]**



 (Q. Settings) →  → [Picture] → [Picture Mode Settings] → [Picture Options]

Depending upon the input signal or the selected picture mode, the available options may differ.

The configurable items differ depending upon model.

- [Noise Reduction]  
Removes small dots that stand out so as to make the image clean.
- [MPEG Noise Reduction]  
Reduces the noise produced during the creation of digital video signals.
- [Smooth Gradation]  
It reduces jaggies in the picture for a smooth picture.
- [Black Level]  
Compensates the screen brightness and contrast by adjusting the darkness of the screen.
- [Real Cinema]  
Provides a cinema-like experience.
- [TruMotion]  
This feature is available on certain models only.  
Optimizes the image quality of fast-moving pictures.
  - [Off]: Turns off the [TruMotion].
  - [Smooth]: Softens fast-moving pictures.
  - [Clear]: Makes fast-moving pictures clearer.
  - [User]: Sets [TruMotion] manually.
    - [De-Judder]: Adjusts juddering on the screen.
    - [De-Blur]: Reduces the blurring effects of motion.
    - The advanced settings can be changed only in [User] mode.

**[Aspect Ratio]**



 (Q. Settings) →  → [Picture] → [Aspect Ratio Settings] → [Aspect Ratio]

Depending upon the input signal, the available screen sizes may be different.

The configurable items differ depending upon model.

- [16:9]  
Displays an aspect ratio of 16:9.
- [Original]  
Changes the aspect ratio to 4:3 or 16:9 depending upon the input video signal.
- [4:3]  
Displays an aspect ratio of 4:3.
- [Vertical Zoom]  
You can adjust the vertical dimension of the screen and align the screen vertically by using [Adjust Zoom Ratio] and [Adjust Screen Position].
- [All-Direction Zoom]  
You can adjust the horizontal/vertical/diagonal dimensions of the screen and align the screen horizontally/vertically by using [Adjust Zoom Ratio] and [Adjust Screen Position].

**[Just Scan]**



 (Q. Settings) →  → [Picture] → [Aspect Ratio Settings] → [Just Scan]

If you turn this feature [On], you can view the content in the aspect ratio that is in content source. If the edge of the screen is not clean, please turn it [Off].

If set to [Auto], the feature switches between [On] or [Off] status depending on the information contained in the video signal.

- The items that can be selected may vary depending on the current input.

**[Energy Saving]**

 (Q. Settings) →  → [Picture] → [Energy Saving]

Reduces power consumption by adjusting peak screen brightness.

- [Minimum]/[Medium]/[Maximum]  
Applies the pre-set [Energy Saving] mode.



**[Picture Test]**

 (Q. Settings) →  → [Picture] → [Picture Test]

First of all, start the picture test to see whether the video signal output is normal, and then select whether there is an error.

If there are no problems in the test picture, check the connected external device.

**[HDMI ULTRA HD Deep Colour]**

 (Q. Settings) →  → [Picture] → [Additional Settings] → [HDMI ULTRA HD Deep Colour]

If the device connected to the HDMI Input Port also supports ULTRA HD Deep Colour, your picture may be clearer.

However, if the device doesn't support it, it may not work properly. In that case, change the Projector's ULTRA HD Deep Colour setting to [Off].

- Supported Display Resolution
  - On: Supports 4K@60 Hz (4:4:4, 4:2:2, and 4:2:0)
  - Off: Supports 4K@60 Hz (4:2:0)



4K@50/60 Hz Supported Format

| Resolution                   | Frame rate (Hz) | Colour Depth/Chroma Sampling |                           |                           |
|------------------------------|-----------------|------------------------------|---------------------------|---------------------------|
|                              |                 | 8 bit                        | 10 bit                    | 12 bit                    |
| 3840 × 2160p<br>4096 × 2160p | 50              | YCbCr 4:2:0                  | YCbCr 4:2:0 <sup>1)</sup> |                           |
|                              | 59.94           | -                            | -                         | YCbCr 4:2:2 <sup>1)</sup> |
|                              | 60              | YCbCr 4:4:4 <sup>1)</sup>    | -                         | -                         |
|                              |                 | RGB 4:4:4 <sup>1)</sup>      | -                         | -                         |

1) Supported when [HDMI ULTRA HD Deep Colour] is set to [On].



- Settings are changeable only for the HDMI input currently being used.
- You can specify a different setting for each HDMI port.
- Some models may not be supported.

**[Instant Game Response]**

 (Q. Settings) →  → [Picture] → [Additional Settings] → [Instant Game Response]

Set the HDMI port connected to the device to be [On] to enjoy games with the optimal video for the game.

However, if the device doesn't support it, it may not work properly.

- Set the [HDMI ULTRA HD Deep Colour] feature to [On] for the HDMI terminal connected to the gaming device to enable [Instant Game Response].
- It works only when the  (Q. Settings) →  → [Sound] → [Sound Out] is [Internal Projector Speaker]/[Wired Headphones]/[Internal Projector Speaker + Wired Headphones].
  - The configurable items differ depending upon model.
- When the [Instant Game Response] is launched, the video may blink temporarily.
- If you turn this feature [On], you cannot change some video settings items.



## [Sound] Settings

### [Adaptive Sound Control]

 (Q. Settings) →  → [Sound] → [Adaptive Sound Control]



Automatically optimize sound based on content type.

This setting is only available for Internal Projector Speaker.

In the list, click on to enable this mode.

- If this feature is turned on, you can't adjust the [Sound Mode] manually.
- Some models may not be supported.

### [Sound Mode]

 (Q. Settings) →  → [Sound] → [Sound Mode Settings] → [Sound Mode]

You can select the most suitable sound mode for each genre.

- [Standard]  
Optimizes the sound for all types of content.
- [Cinema]  
Optimizes the sound for cinemas.
- [Clear Voice III]  
Boosts voice clarity.
- [Sports]/[Cricket]  
Optimizes the sound for sports.
  - The name of the sport may differ depending on region.
- [Music]  
Optimizes the sound for music.
- [Game]  
Optimizes the sound for gameplay.

**[Sound Mode Settings]**



 (Q. Settings) →  → [Sound] → [Sound Mode Settings]

The configurable items differ depending upon model.



- [Sound Mode]  
You can select the most suitable sound mode for each genre.
- [Balance]  
You can adjust the volume of the left and right speakers.
- [ULTRA Surround]  
Enjoy an immersive soundscape with the virtual multi-channel surround sound effect.
  - The option can be enabled if [Sound Mode] is set to [Standard].
- [Equalizer]  
You can set the desired sound by adjusting the equalizer directly.  
(100 Hz/300 Hz/1 kHz/3 kHz/10 kHz)
  - The option can be enabled if [Sound Mode] is set to [Standard].
- [Reset]  
You can reset the sound effect settings.
  - The option can be enabled if [Sound Mode] is set to [Standard].

**[Sound Out]**

The configurable items differ depending upon model.

- When [Instant Game Response] is set to [On], audio delays may occur if you set [Sound Out] to [Bluetooth]/[Optical]/[HDMI ARC].  
Switch to [Internal Projector Speaker] or change  **(Q. Settings)** →  → [Sound] → [HDMI Input Audio Format] to [PCM].

**Playing audio through the projector's internal speakers**

 **(Q. Settings)** →  → [Sound] → [Sound Out] → [Internal Projector Speaker]  
Audio is played through the projector's internal speakers.

**Connecting and Using an Audio Device Supporting Optical**

 **(Q. Settings)** →  → [Sound] → [Sound Out] → [Optical]

You can connect an audio device that supports [Optical] to the optical digital audio output port to enjoy your projector's sound in richer quality and greater convenience.

- Only available for models with an optical digital port.
- You can use the projector remote control to adjust the volume of the connected device.
- You can set [Digital Sound Out] ([Auto]/[Pass Through]/[PCM]) and [LG Sound Sync] ([On]/[Off]).



**Hearing Sound through an External Audio Device Connected via a HDMI (ARC) Port**

 **(Q. Settings)** →  → [Sound] → [Sound Out] → [HDMI ARC]

Sound from the projector can be output through an external audio device connected via a HDMI (ARC) port.

- Select [HDMI ARC] to automatically turn on SIMPLINK. Once SIMPLINK is turned off, the output speaker settings automatically revert to the default settings for uninterrupted audio output.
- You can set [Digital Sound Out] ([Auto]/[Pass Through]/[PCM]).

## Configuring digital sound output settings

 (Q. Settings) →  → [Sound] → [Sound Out] → [Optical]/[HDMI ARC] → [Digital Sound Out]

You can configure the [Digital Sound Out] settings.

- These settings are available only when an [Optical]/[HDMI ARC] is selected.
- When [Pass Through] is enabled, sound effects may not be output.
- The codec output with a device may differ from input signals.

|                              | Sound Input                | Digital Sound Output  |
|------------------------------|----------------------------|---|
| [PCM]                        | All                        | PCM   |
| [Auto]<br>/[Pass<br>Through] | MPEG                       | PCM   |
|                              | Dolby Digital              | Dolby Digital   |
|                              | Dolby Digital Plus / Atmos | (Optical) Dolby Digital<br>(HDMI ARC) Dolby Digital Plus / Atmos  |
|                              | Dolby TrueHD (HDMI only)   | (Optical) Dolby Digital<br>(HDMI ARC) Dolby Digital Plus / Atmos<br>(HDMI ARC eARC On) TrueHD <sup>1)</sup> |
|                              | HE-AAC                     | Dolby Digital   |
|                              | DTS                        | DTS   |
|                              | DTS Express                | DTS   |
|                              | DTS-HD MA                  | (Optical / HDMI ARC) DTS<br>(HDMI ARC eARC On) DTS-HD <sup>1)</sup> / DTS                                   |

1) Supported only when [Digital Sound Out] is set to [Pass Through], and the input is set to the HDMI.

- Dolby TrueHD, eARC: Some models may not be supported.

## Connecting and Using an Audio Device Supporting LG Sound Sync

 (Q. Settings) →  → [Sound] → [Sound Out] → [Optical] → [LG Sound Sync]

You can connect an audio device that supports [LG Sound Sync] to the optical digital audio output port to enjoy your projector's sound in richer quality and greater convenience.

- Only available for models with an optical digital port.
- You can use the projector remote control to adjust the volume of the connected device.



## Connecting and Using an Audio Device Wirelessly

 (Q. Settings) →  → [Sound] → [Sound Out] → [Bluetooth]

You can connect wirelessly a Bluetooth audio device or a Bluetooth headset to enjoy your projector's sound in richer quality and greater convenience.

- If you have recently connected device that the sound bar supports LG Sound Sync, this feature automatically tries connecting to that device.
- In some devices, this feature automatically tries connecting to the recently connected device when the projector is turned on.
- We recommend that you connect an LG audio device that supports LG Sound Sync, using LG TV mode or LG Sound Sync mode on device.
- Some models may not be supported.
- Press [DEVICE SELECTION] to view the connected devices or the devices that can be connected to connect any one of them.
- You can use the projector remote control to adjust the volume of some Bluetooth devices.
- If the device fails to connect, check the power of the device to connect to and check if the audio device is working properly.
- Depending on the type of the Bluetooth device, the device may not connect correctly or an abnormal behavior may occur such as unsynchronized video and audio.
- Sound may stutter or sound quality may be reduced if:
  - the Bluetooth device is too far from the projector;
  - there are obstacles between the Bluetooth device and the projector; or
  - used together with radio equipment such as a microwave oven or wireless LAN.
- If the [Picture Mode] is set to [Game] and [Sound Out] is set to [Bluetooth], [Picture Mode] changes to [Standard].
- Using Bluetooth speakers that support Dual mode/Double mode/2-Channel mode together with the Magic Lighting Remote may limit the speakers' usability.





## Using Wired Headphones

 (Q. Settings) →  → [Sound] → [Sound Out] → [Wired Headphones]  
Select [Wired Headphones] to optimize audio output according to the device connected.

- Only available for models with a Wired Headphones port.
- Some models may not be supported.
- If you connect the wired headphones while the projector is powered on, it automatically detects the wired headphones and redirects audio through them.

## Playing audio through the projector's internal speakers and external audio device simultaneously

Audio can be played through multiple devices simultaneously.

- Using [Internal Projector Speaker + Optical]  
 (Q. Settings) →  → [Sound] → [Sound Out] → [Internal Projector Speaker + Optical]
  - Audio is played through the projector's built-in speakers and the audio device connected to the digital optical audio output port simultaneously.
  - Only available for models with an optical digital port.
- Using [Internal Projector Speaker + Wired Headphones]  
 (Q. Settings) →  → [Sound] → [Sound Out] → [Internal Projector Speaker + Wired Headphones]  
Audio is played through the projector's internal speakers and the [Wired Headphones] simultaneously.
  - If you connect the wired headphones while the projector is powered on, it automatically detects the wired headphones and redirects audio through them.
  - Only available for models with a Wired Headphones port.
  - Some models may not be supported.

**[HDMI Input Audio Format]**

 (Q. Settings) →  → [Sound] → [HDMI Input Audio Format]

You can set the audio format for each HDMI input. When the voice delivered through the HDMI port is not synchronized, set it to [PCM].

**[Auto Volume]**

 (Q. Settings) →  → [Sound] → [Auto Volume]

Click [On] to adjust the volume level automatically.

**[AV Sync Adjustment]**

 (Q. Settings) →  → [Sound] → [AV Sync Adjustment]

Adjusts the synchronization of the sound from the speaker that is working.

The closer to (+), the slower the audio output.

If you select the [Bypass], Outputs the sound from external devices without any audio delay. The audio may be output before the video because of the time the projector takes to process the video input.

**[Sound Test]**

 (Q. Settings) →  → [Sound] → [Sound Test]

Start the [Sound Test] to check that the sound signal output is normal, and then select whether there is an error.

If there are no problems in the test, check the connected external device.

- Sound test is possible by Internal projector Speaker only.

## [Connection]

### [Projector Name]

 (Q. Settings) →  → [Connection] → [Projector Name]

You can use the screen keyboard to set the name for the smart projector to be used on the network.

- Up to 25 characters can be entered using the English alphabet.

### [Wired Connection (Ethernet)]

 (Q. Settings) →  → [Connection] → [Wired Connection (Ethernet)]

The projector will be connected automatically to the network if a cable connection is established.

To change network connection settings, select [Edit] in Network Settings.

- The IPv6 setup does not support [Edit].

### [Wi-Fi Connection]

 (Q. Settings) →  → [Connection] → [Wi-Fi Connection]

If you have set up the projector for a wireless network, you can check and connect to the available wireless Internet networks.

- [Add a Hidden Wireless Network]  
If you input the name of network directly, you can add a wireless network.
- [Connect via WPS PBC.]  
Connects easily when the button of a wireless AP supporting PBC is pressed.
- [Connect via WPS PIN.]  
Connects easily when the PIN of the wireless AP that you wish to connect to is entered in to the AP configuration webpage.
- [Advanced Wi-Fi Settings]  
If you input the information of network directly, you can enter a wireless network.
  - The IPv6 setup does not support [Edit].



**[Device Connector]**

 (Q. Settings) →  → [Connection] → [Device Connector]

This feature is to enable you to easily set the connection between the projector and external device.

Follow instructions in [Device Connector].

**[Mobile Projector On]**

 (Q. Settings) →  → [Connection] → [Mobile Projector On]

If [Turn on via Wi-Fi] or [Turn on via Bluetooth] is set to [On], you can turn on your projector using an application that supports [Mobile Projector On] or see the screen of the application on your projector.

- The [Turn on via Wi-Fi] feature must be used in an app on a smart device that supports the feature.
- The [Turn on via Bluetooth] feature can only be used with certain LG Electronics smartphones.
- The projector should be connected to a network.
- The projector must be plugged in.
- The projector and the device to be used should be connected to the same network.
- To connect for the first time, make sure the device to be used is ready to connect.
- Some models may not be supported.

### [Screen Share Settings]

 (Q. Settings) →  → [Connection] → [Screen Share Settings]

You can press the [DELETE PAIRING HISTORY] to delete the connections of the devices connected to the projector by the Screen Share.

### [HDMI Device Settings]

 (Q. Settings) →  → [Connection] → [HDMI Device Settings]

You can link information of devices connected to the projector via the HDMI® cable to set the devices to be controlled by the projector remote control.

The configurable items differ depending upon model.

- [Auto Device Detection]  
It automatically sets to enable you to control the devices connected via the HDMI with the Magic Lighting Remote.
- [SIMPLINK (HDMI-CEC)]  
You can conveniently control and use various multimedia devices connected through HDMI with the projector remote control.
- [Auto Power Sync]  
If [Auto Power Sync] is set to [On], turning on a SIMPLINK-linked device will turn the projector on. When you turn off the projector, the device will also be turned off.

## [General]

### [Language]

 (Q. Settings) →  → [General] → [Language]

You can choose the menu language displayed on the screen.

- [Menu Language]  
You can select one of the menu languages to be displayed on the screen.
- [Keyboard Languages]  
Select the language to use the on-screen keyboard.

### [Location]

 (Q. Settings) →  → [General] → [Location]



You can change the location setting of your smart projector.

You must set the country manually when you are not connected to the network.

The configurable items differ depending upon the country.

- [Service Area Postcode]  
This function is used to set the receiving location of the projector by entering your postcode.
- [LG Services Country]  
If you don't set the [Set Automatically], you can select the country manually.

**[Time & Date]**

 (Q. Settings) →  → [General] → [Time & Date]

You can check or change the time while watching the projector.

- [Set Automatically]  
Automatically sets the time displayed on the projector screen by network.
- [Time]/[Date]/[Time Zone]  
You can set the time and date manually if the automatically set current time is incorrect.
- [Custom Time Zone]  
When select the [Custom] in [Time Zone], [Custom Time Zone] menu is activated.



**[Sleep Timer]**

 (Q. Settings) →  → [General] → [Timers] → [Sleep Timer]

Sets the projector to turn off at a specified time.

If you want to disable [Sleep Timer], select [Off].

**[Timer Power On]/[Timer Power Off]**

 (Q. Settings) →  → [General] → [Timers] → [Timer Power On]/[Timer Power Off]

You can set the power on/off time for the projector.

Select [Off] if you are not going to set [Timer Power On]/[Timer Power Off].

- To use [Timer Power On]/[Timer Power Off], set the time correctly.

**[Auto Off]**

 (Q. Settings) →  → [General] → [Timers] → [Auto Off]

If there is no input signal or button press, the projector automatically turns off after the preset time has elapsed.

**[Edge Adjustment]**



 (Q. Settings) →  → [General] → [Edge Adjustment]

[Edge Adjustment] adjusts the horizontal and vertical sides of the projected image if the projector is at an angle and not perpendicular to the screen. This feature ensures the shape of the projected image is not distorted.

Use this feature only when the projector cannot be set up at the optimal angle. [Edge Adjustment] may result in a loss of image quality.

- Some models may not be supported.

**[Auto Keystone]**

 (Q. Settings) →  → [General] → [Auto Keystone]

[Auto Keystone] provides a rectangular screen image by automatically adjusting the keystone number when there is a trapezoidal screen image caused by tilting of the projector.

- [On]  
Automatically adjusts the keystone number.
- [Off]  
Manually adjusts the keystone number.
- Some models may not be supported.

**[Keystone]**

 (Q. Settings) →  → [General] → [Keystone]

To prevent the screen image from becoming trapezoidal, Keystone adjusts the top and bottom width of the image if the projector is not set at a right angle to the screen.

- Some models may not be supported.

**[PJT Mode]**

 (Q. Settings) →  → [General] → [PJT Mode]

This function turns the projected image upside down or flips horizontal.

**[AI Service]**

 (Q. Settings) →  → [General] → [AI Service]

You can enable the recommended services based on the usage history.

The configurable items differ depending upon model.

- [AI Recommendation]

You can get content recommendations messages according to your content viewing history and app usage history.

- [USAGE DATA RESET]

It resets the content view history and the app usage history. If you reset them, it takes some time to receive recommendations for contents again.

**[Account Management]**

 (Q. Settings) →  → [General] → [Account Management]

Manage your account information and settings.

**[ECO Mode]**

 **(Q. Settings)** →  → [General] → [ECO Mode]

Set power options to reduce energy consumption.

- [Auto Power Off]  
Set the projector to turn off automatically when there has been no user input for a specified amount of time.
- [HDD ECO Mode]  
If you set the mode to [On], the USB HDD connected to the projector will go into power-saving mode when it has been left unattended for an extended period of time.



**[About This Projector]**

 **(Q. Settings)** →  → [General] → [About This Projector]

You can check the information about Customer Services, (Software Update, projector Information, and so on.)

You can run the [Notifications] to check a notification received while you are using the projector. To check the status of the projector, please run the [Quick Help].

**[LG Wireless Keyboard]**



 **(Q. Settings)** →  → [General] → [Additional Settings] → [LG Wireless Keyboard]

This feature enables you to connect a LG wireless keyboard to your device.

Turn on the device, set it to pairing mode, and then click [CONNECT] on your projector screen.

- Supported keyboard
  - LG Rolly Keyboard
- If there is a LG wireless keyboard previously connected, it will be automatically reconnected to your projector once your projector turns on.
- To disconnect the existing connection, click [DISCONNECT].
- Some models may not be supported.



**[Settings Help]**

 **(Q. Settings)** →  → [General] → [Additional Settings] → [Settings Help]

If you select the setting menus, you will see the hints of the settings. Turn on/off description box in settings.





**[Screen Saver]**

 **(Q. Settings)** →  → [General] → [Additional Settings] → [Screen Saver]

When the currently displayed app has not received any user input for an hour, it will be replaced by a [Screen Saver].

- Setting the [Screen Saver] feature to [Off], maintains the same display for an extended period, which may compromise quality. The compromised screen may not be recoverable.



**[No Signal Image]**

 **(Q. Settings)** →  → [General] → [Additional Settings] → [No Signal Image]

You can turn on or off the image displayed when there is no signal.

- [On]  
The default image is displayed if there is no signal.
- [Off]  
The [No Signal] message is displayed if there is no signal.



**[Auto Power]**

 **(Q. Settings)** →  → [General] → [Additional Settings] → [Auto Power]

Makes the projector turn on automatically when the power cord is connected to the projector.

- [On]  
When the power cord is connected to the projector, it turns on automatically.
- [Off]  
When the power cord is connected to the projector, it goes into standby mode.

**[High Altitude]**

 (Q. Settings) →  → [General] → [Additional Settings] → [High Altitude]

If the projector is used at an altitude higher than 1200 meters, turn this on.

Otherwise, the projector may overheat or its protection function may be activated. If this happens, turn the projector off and then on again after waiting for several minutes.

- Some models may not be supported.

**[Home/Store Mode]**

 (Q. Settings) →  → [General] → [Additional Settings] → [Home/Store Mode]

You can choose between [Home Mode] and [Store Mode].

To use the projector at home, select [Home Mode].

Select [Store Mode] only when the projector will be displayed in store. The [Store Mode] provide settings optimized for store display.

**[Reset to Initial Settings]**

 (Q. Settings) →  → [General] → [Reset to Initial Settings]

Return projector to its initial settings. This will revert all settings to their default values.

After reset, the projector will automatically turn off and on.

- If [Safety] is set to [On], you should type the password to [Reset to Initial Settings].
- Do not turn off the power during initialization.
- We recommended that you reset the projector to [Reset to Initial Settings] before you sell it or transfer it to a third party.

## [Safety] Settings

- Set [Safety] to [On].
- The initial password is set as "0000".  
When France is selected for Country, password is not "0000" but "1234".
- The configurable items differ depending upon model.



### [Application Locks]

 (Q. Settings) →  → [Safety] → [Application Locks] → Select the Applications to lock.

You can lock or unlock the application.

- The lock function is not immediately available for the currently running application.

### [Input Locks]











 (Q. Settings) →  → [Safety] → [Input Locks] → Select the Inputs to lock.  
You can lock or unlock the Input Locks.

### [Reset Password]

 (Q. Settings) →  → [Safety] → [Reset Password]  
Set or change the password for the projector.

### Resetting a Lost Password

If you lose the password you set, you can reset it as follows:

- 1 Press the  (Q. Settings) button on the remote control and move the focus to  → [Safety] → [Reset Password].
- 2 Press   →   →   →   on the remote control. The master password input window will appear.
- 3 Enter the numbers "0313" in the master password input window, then press [Enter]. The password will be reset.

## [Accessibility]

### [Pointer Options]

 (Q. Settings) →  → [Accessibility] → [Pointer Options]

You can set the pointer speed and size you want while it is on the screen.

### [Menu Transparency]

 (Q. Settings) →  → [Accessibility] → [Menu Transparency]

By setting this feature to [On], you can make some of the menus (e.g. Search, etc.) transparent.

### [High Contrast]

 (Q. Settings) →  → [Accessibility] → [High Contrast]



When this feature is set to [On], it adjusts the background of some of the menus on the screen and font Colours to highlight the contrast between the light and dark areas.

# TO UPDATE SOFTWARE

Uses software update to check and obtain the latest version.

- The configurable items differ depending upon country.
- The latest version can be obtained via internet connections.
- If software is not updated, certain functions may not work properly.
- In some countries, [Allow Automatic Updates] is not displayed if you are not connected to the internet.



## [CHECK FOR UPDATES]

 (Q. Settings) →  → [General] → [About This Projector] → [CHECK FOR UPDATES]

When checking for the latest update version, you can perform updates only if an update file of a later version is available.

The projector automatically checks your software version but, if necessary, you can perform a manual check.

## [Allow Automatic Updates]



 (Q. Settings) →  → [General] → [About This Projector] → [Allow Automatic Updates]

If [Allow Automatic Updates] is selected, when an update is available, the update automatically starts without prompting a question.

If [Allow Automatic Updates] is not selected, when an update is available, the update will start after prompting a question.



# TROUBLESHOOTING

If you experience any of the problems below while using the product, please check the following. There may be no problem with the product.

Information on customer service for product problems is available in  (Q. Settings) →  → [General] → [About This Projector] on the projector.

## Perform Check-up with the [Quick Help].

When the projector malfunctions, you can get help to solve the problem.

- 1** Press  (Q. Settings) button on the remote control and select  → [General] → [About This Projector] → [Quick Help].
    - You can also long-press the number  button of the remote control to run the [Quick Help].
  - 2** You can perform the [Check the status of Projector]/[Self-Diagnosis of Projector Settings].

Select the problematic item, and you can get help to solve the problem.

    - [Self-Diagnosis of Projector Settings]: Select the item that matches the symptom to find instructions that can help you solve the problem.
    - [Check the status of Projector]: You can check your projector's current status for the selected item.
- When there is no related content in the [Quick Help], please refer to the Troubleshooting.
  - If you still fail to solve the problem, please contact our customer service center.

## Abnormal Operation

### Power/Remote Control Errors

#### **I cannot turn on the Projector.**

- Please make sure your projector power plug is correctly connected to the outlet.
- If you are using a multi-outlet, check if it is working properly. To check whether a power strip is working properly, plug the projector's power plug directly to a wall outlet and observe its operation.
- Try to power on using the button on your projector set.

#### **The screen does not appear for some time after power-on.**

- This is because there is a noise-removal process to eliminate any possible noise that may appear during power-on. This does not mean the product is defective.

#### **The pointer of Magic Lighting Remote does not appear on the screen.**

- Hold the remote control towards the projector and long-press **PICTURE** button until the instruction appears. The previously registered remote control is deregistered and then registered again.
- Replace the batteries when you are prompted to do so on your projector screen. (Use Alkaline batteries.)

#### **I cannot turn the projector on with the remote control.**

- Please make sure your projector power plug is correctly connected to the outlet.
- Replace the batteries in the remote control. (Use alkaline batteries.)
- Check whether there are any obstacles in front of the projector's remote control sensor. Sound bars or other obstacles placed in front of the projector's lower receiver may obstruct IR signal reception.

## Screen Problems

First of all, perform a  (**Q. Settings**) →  → [Picture] → [Picture Test] to check for any abnormalities in the projector.

If you are using a set-top box, turn it off, and then turn it back on.

Make sure that the set-top box is correctly connected to your projector.



### **It says there is no signal on the screen.**

- Make sure that the HDMI® cable is correctly connected to your projector.
- Go to  to choose the connected input.
- Check if your external device, such as set-top box or Blu-ray player, is turned on.

### **The screen shakes after the momentary appearance of vertical/horizontal lines and net pattern.**

- Stop using items such as wireless telephones, hairdryers, electrical drills etc. The problem is caused by high-frequency electronic devices such as another projector or strong electromagnetic sources.

### **I see vertical lines in all four directions on the screen, or Colours are blurred when I try to connect to HDMI.**

-  (**Q. Settings**) →  → [Picture] → [Aspect Ratio Settings] → [Just Scan] Set [Just Scan] to [Off].





[Just Scan] shows you the original image as it is. You may see noise in all four directions on the screen if the signal contains noise.



**I don't see anything, or the image keeps flickering when i try to connect the HDMI® cable.**

- Check whether your HDMI® cable is compliant with the specifications. You may experience flickering or a blank screen if the HDMI® cable is faulty (bent, broken).
- Make sure that the cable is correctly connected to the port. Bad or loose contact may cause display problems on the screen.

**The screen looks too dim or dark.**

-  (Q. Settings) →  → [Picture] → [Picture Mode Settings] → [Picture Mode]  
Switch [Picture Mode] to your desired picture mode. ([Standard], [Vivid], etc.)  
This applies to the current input mode only.
-  (Q. Settings) →  → [Picture] → [Energy Saving]  
Switch [Energy Saving] to [Minimum].

**The screen is in black and white or displaying strange Colours.**

- Check the input mode or cable connection.
- Go to  to choose the connected input.



## Sound Problems

First of all, perform a  (**Q. Settings**) →  → [Sound] → [Sound Test] to check for any abnormalities in the projector.



If you are using a set-top box, turn it off, and then turn it back on.

Make sure that the set-top box is correctly connected to your projector.



### The screen is fine, but it does not play any sound.

- If you use a set-top box, there will be no sound if you have set the volume of the set-top box or your projector to 0 or enabled Mute. Set the volume to an appropriate level.
-  (**Q. Settings**) →  → [Sound] → [Sound Out]  
Set the [Sound Out] to [Internal Projector Speaker] or [Internal Projector Speaker + Optical], and then check it once again. If you can hear the sound just fine, you need to set the external speakers connected such as a soundbar.

### There is no sound coming from one of the speakers.

-  (**Q. Settings**) →  → [Sound] → [Sound Mode Settings] → [Balance]  
Adjust the balance as necessary with the Navigation button in [Balance].

## PC Connection Problems



Press and hold the  button on the remote control to select the  on the top right of [Home Dashboard]. In the edit mode, set the icon of the HDMI terminal connected to the PC to [PC] to apply the video and aspect ratio settings that are aligned with the PC. To connect a different device to the same input terminal, you need to set the icon again because the settings of the edit icon will not be automatically restored.

If you experience any of the problems below while using the product, please check the following. There may not be a problem with the product.

### **The screen remains blank after it is connected to a PC.**

- Check that the PC is properly connected to the projector.
- Turn the projector off and back on using the remote control.
- Restart the PC with the projector on.
- Check that the current screen resolution supports the PC input.
- To use dual monitors, check that the PC or notebook supports dual-monitor mode.
- Reconnect the high speed HDMI® cable.
- If you have connected the RGB output port of your PC to the HDMI input port or your projector. You need an RGB to HDMI gender.  
You will not see anything on the screen if you use an HDMI to RGB gender.

### **The screen is cut off or moved to one side after it is connected to a PC.**

- Set the PC's resolution to one supported by the projector.
- Set the connected HDMI device's name to PC.
- Press and hold the  button on your remote control. Select the  in the upper right corner and change the icon of the HDMI terminal connected to [Inputs] to PC.

### **The sound does not play when the PC is connected with an HDMI® cable.**

- Configure projector as your default device in Control Panel → Sound in your PC settings.
- Consult your manufacturer on whether your graphics card supports HDMI audio output.

## [Photo & Video] Movie Playback Problems

For more information about supported files, see “[Photo & Video]”.

### **I cannot find a file in the [Photo & Video].**

- Check that the files on the USB storage device can be read by a PC.
- Check that the file extension is supported.

### **I get a message saying “This file is not supported” or the sound is playing normally but the video is not.**

- Check that the file plays without any problems on a PC’s video player. Also check for file damage.
- Check that the file extension is supported.
- Check that the resolution is supported.
- Check that the video codec is supported.
- Check that the frame rate is supported.



### **I get a message saying “This audio is not supported” or the video is playing normally but the audio is not.**

- Check that the file plays without any problems on a PC’s video player. Also check for file damage.
- Check that the file extension is supported.
- Check that the audio codec is supported.
- Check that the bit rate is supported.
- Check that the sample rate is supported.
- Check that the audio channel separation is supported.

**I cannot see the subtitles.**

- Check that the file plays without any problems on a PC's video player. Also check for file damage.
- Check that the video and subtitle files have the same name.
- Also check that both the video file and the subtitle file are in the same folder.
- Check that the subtitle file format is supported.
- Check that the language is supported. (You can check the language of the subtitle file by opening the file in the Notepad.)

If subtitles encoding is incorrectly set, subtitles may not be displayed properly.

Select  →  in the control panel at the bottom of the video playback screen and change the [CODE PAGE] value.





- If you play a video file stored on another device by using the content sharing feature, subtitles may not be available depending on the program you use.
- Subtitles are not supported if you are playing video through an NAS unit. Consult your NAS manufacturer.

**My USB storage device is not recognized when connected.**

- Check whether it is a USB storage device supported by the projector.

## Network Connection Problems

You can check the network connection status as shown below.

-  (Q. Settings) →  → [Connection] → [Wired Connection (Ethernet)]
-  (Q. Settings) →  → [Connection] → [Wi-Fi Connection] → [Advanced Wi-Fi Settings]

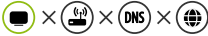

### When X appears next to projector

- Check the projector or the AP (Router).
- Check the connection status of the projector, AP (Router) and Cable Modem.
- Power off and power on in the following order;
  1. The Cable Modem, wait for the Cable Modem to reset.
  2. The AP (Router), wait for the AP (Router) to reset.
  3. The projector.
- If you are using a wireless connection, change the SSID (Network name) and wireless channel of AP (Router).
- If you are using a static IP, enter the IP directly.
- Contact internet service provider or AP (Router) companies.



### When X appears next to Gateway

- Check the AP (Router) or consult your Internet service provider.
- Unplug the power cord of the AP (Router), Cable Modem, wait 10 seconds. Reapply power.
- Initialize (Reset) on the AP (Router) or Cable Modem.
- Contact internet service provider or AP (Router) companies.
- Check the AP (Router) manufacturer's website to make sure your router has the latest firmware version installed.



### When X appears next to DNS

- Check the AP (Router) or consult your Internet service provider.
- Unplug the power cord of the Cable Modem or the AP (Router), wait 10 seconds. Reapply power.
- After the Cable Modem or AP (Router) has Initialized (Reset), try to reconnect.
- Check that the MAC address of the projector/AP (Router) is registered with your Internet service provider. (The MAC address displayed on the pane of the network status window should be registered with your Internet service provider.)

## LG Account Problems

In some countries, access to the website ([www.lgappstv.com](http://www.lgappstv.com)) may be restricted.

### **I have already signed up on the projector. Do I still have to sign up again at the website ([www.lgappstv.com](http://www.lgappstv.com))?**

- If you have already signed up on your projector, you do not have to sign up again on the website.

You can sign into the website by using the same ID and password and entering the additional information to complete the email verification process.



### **I forgot my ID/Password. What should I do?**

- You can initialize the password through E-mail when you select FORGOT PASSWORD? on the sign in screen.
- If you signed up on a PC, you can find your ID/Password on the website ([www.lgappstv.com](http://www.lgappstv.com)).



## Contents Problems

### I cannot see any content in HOME.

- You may not be able to see the content if the service country setting has been changed. Change to the service country you are going to use the service from in  (**Q. Settings**) →  → [General] → [Location] → [LG Services Country]. (Some models may not be supported.)
- You may not be able to view content that has been deleted. Please reinstall the appropriate app.
- The type of supported content differs by country.
- The content offerings are subject to change or interruption by the service provider.
- If the app is deleted, you can download the app at [LG Content Store] and re-install it. Go to  → [LG Content Store] to find and install the app you want.

## Internet Browser Problems

### **Some parts of a particular website are not visible when I am using the Internet.**

- The [Web Browser] supports only HTML5 media and not Flash Plug-in.
- The [Web Browser] does not support plug-in installation.
- On the [Web Browser], it may not be possible to play media files in formats other than JPEG/PNG/GIF.
- You cannot save attachments or images.

### **The Internet browser automatically shuts down when I visit a website.**

- The Internet browser may be forced to shut down if the available memory size is not sufficient to accommodate the image information for a website.

### **When watching a video in [Web Browser], the video is forced off.**

- You may be able to fix this by setting [Settings] → [Adaptive Streaming using JavaScript] to [Off] in [Web Browser]. The setting is not applied to tabs that were open before the change, and is only applied to tabs opened after the change.

