

EPOS

IMPACT 200 Series

Maintain energy and focus with clear communication between you and your listener and enjoy robust wired headsets with all-day comfort. In busy contact centers these headsets are both reliable and user-friendly



We are rebranding from EPOS | SENNHEISER to EPOS branding on our products. During the transition period the same product may exist in both versions

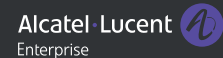

Key Features

Enjoy all-day wearing comfort

Acoustic foam ear pads with soft leatherette covers and CircleFlex™ dual-hinge ear cup system for a perfect fit

Experience communication with clarity

With EPOS Voice™ technology and noise-cancelling microphone for natural, clear conversation

See more at eposaudio.com/impact-200

Benefit from robust design

Durable construction with lightweight, metal reinforced headband designed for years of daily use

Protect your hearing

From acoustic shock with EPOS ActiveGard® technology

Easy call management

With in-line call control unit to mute, adjust volume and answer/end calls



What's in the Box

Carry pouch

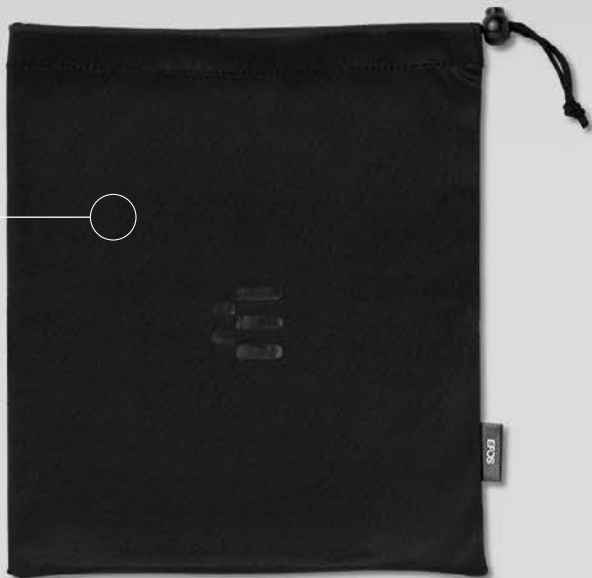

IMPACT 200



Quick Guide



Safety Guide

Cable/clothing clip mounted



How to Use the IMPACT 200

Adjusting and wearing the headset

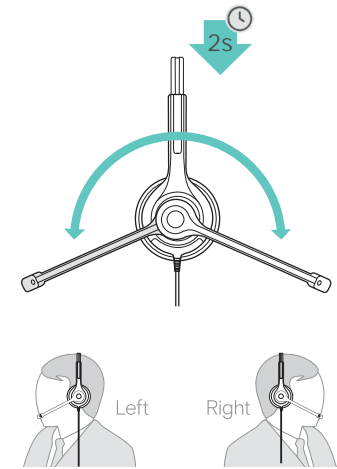
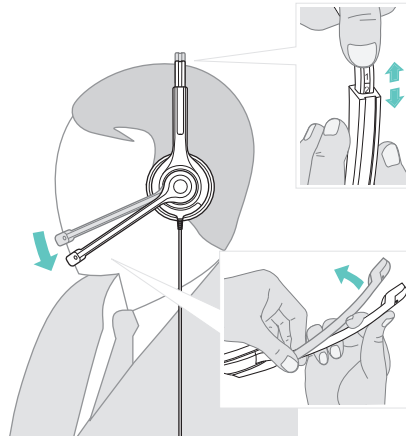

Accept/end a call

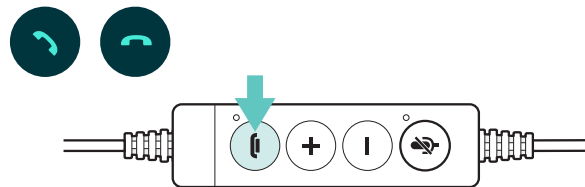

Redialing

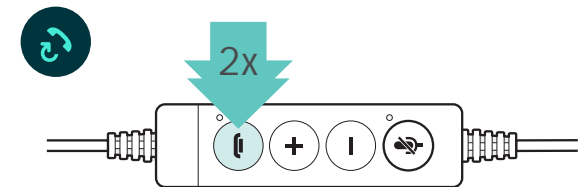

Adjusting the volume

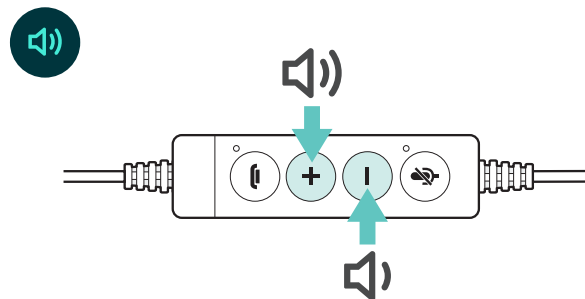

Mute/unmute

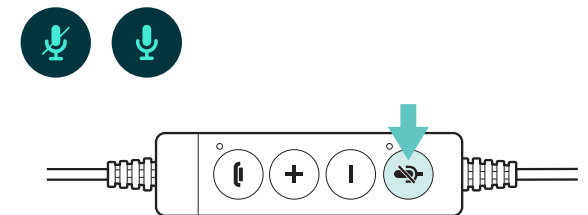

Additional benefits & features



Benefit from robust design

Durable construction with lightweight, metal reinforced headband for heavy use



Switchable Noise at Work limiter

In compliance with EU Noise at Work Directive (Directive 2003/10/EC)



Personalize your headset

Name tag with user ID and numbered headband grooves to personalize fit



Protect your hearing

EPOS ActiveGard® technology protects users against acoustic injury



Optimize speech transmission

Bendable and pivoting boom arm ensures optimal microphone position



Easy to store and portable

With protective carry pouch

Product data

1/3

General

Wearing style

Headband -single and double-sided variants

Headset weight

Single-sided: 58 g / 2.05 oz
Double-sided: 89 g / 3.14 oz

Connectivity

Desk phone via Easy Disconnect, Softphone/PC via USB

Warranty

2 years

Audio

Speaker frequency response

150 – 6.800 Hz (Wideband)

Microphone type

Noise-cancelling microphone for optimal speech transmission

Microphone frequency response

50 – 18.000 Hz
50 – 12.000 Hz (SC 238 / SC 268)

Noise cancellation

Noise-cancelling microphone

Product data

2/3

Products variants

IMPACT 200

Software

EPOS devices can be managed with following Software solutions:

EPOS Connect

EPOS Manager

What's in the box

Acoustic leatherette ear pad/s mounted on headset, cable/clothing clip mounted, carry pouch, quick guide, safety guide

Conduct firmware updates and configure headsets for personal audio preferences.

EPOS Connect works for Windows, Mac® and VDI/Thin client environments: eposaudio.com/software-epos-connect

Manage, update and configure EPOS audio devices from any location.

For both cloud and on-premises solutions: eposaudio.com/software-epos-manager

Product data

3/3

Product	Connects to	Certi cations	EAN code	UPC code
IMPACT SC 260 USB MS II Art. no. 1000579	PC/Softphone via USB Double-sided, USB headset w. in-line call control	Optimized for UC and certi ed for Microsoft Teams*, Google Meet, Works with Chromebook, Avaya and Alcatel-Lucent Enterprise	57 14708 00380 9	8 40064 40380 1
IMPACT SC 230 USB MS II Art. no. 1000578	PC/Softphone via USB Single-sided, USB headset w. in-line call control	Optimized for UC and certi ed for Microsoft Teams*, Google Meet, Works with Chromebook, Webex by Cisco, and Avaya	57 14708 00379 3	8 40064 40379 5
IMPACT SC 260 Art. no. 1000515	Desk phone via Easy Disconnect (ED) Double-sided headset	Certi ed for Google Meet, Avaya, Alcatel-Lucent Enterprise and Unify	57 14708 00316 8	8 40064 40316 0
IMPACT SC 230 Art. no. 1000514	Desk phone via Easy Disconnect (ED) Single-sided headset	Certi ed for Google Meet, Avaya, Alcatel-Lucent Enterprise and Unify	57 14708 00315 1	8 40064 40315 3
IMPACT SC 262 Art. no. 1000519	Desk phone via Easy Disconnect (ED) Double-sided headset	Certi ed for Google Meet	57 14708 00320 5	8 40064 40320 7
IMPACT SC 232 Art. no. 1000518	Desk phone via Easy Disconnect (ED) Single-sided headset	Certi ed for Google Meet	57 14708 00319 9	8 40064 40319 1
IMPACT SC 268 Art. no. 1000658	Desk phone via Easy Disconnect (ED) Double-sided headset	Certi ed for Google Meet	57 14708 00459 2	8 40064 40459 4
IMPACT SC 238 Art. no. 1000657	Desk phone via Easy Disconnect (ED) Single-sided headset	Certi ed for Google Meet	57 14708 00458 5	8 40064 40458 7

* The Microsoft Teams certi ed products in the IMPACT 200 Series require installation of EPOS Connect - download the software from our website: eposaudio.com/epos-connect

Spare parts

1/1

Product	Art. no.	Description	EAN code	UPC code
HPH 01	1000778	Soft cotton hygiene cover, 10 pcs. For use with leatherette ring ear pads or acoustic foam ear pads. Suitable for following series within the IMPACT line: SC 600, SC 200, SC 30/60, DW, SD, MB Pro and the CC and SH Series.	5714708005797	840064405799
HSH 01	1000785	Headset holder with tape. Suitable for IMPACT SC 600, IMPACT SC 200, IMPACT SC 30/60, CC and SH Series.	5714708005865	840064405867
HZP 30 SC 200	1000790	Acoustic foam ear pads suitable for IMPACT SC 200 Series. Includes 2 pcs.	5714708005919	840064405911
HZP 31 SC 200	1000791	Acoustic foam ear pads with leatherette cover for IMPACT SC 200 Series and IMPACT SC 30/60 Series. Includes 2 pcs.	5714708005926	840064405928
Security Cable Lock	1000819	Security Cable Lock	5714708006206	840064406208
Spare Mic foam, DW20/30	1000710	Microphone Pop Screen (10X)	5714708005117	840064405119
USB-A to USB-C	1000832	Adapter Cable USB-A To USB-C	5714708006336	840064406338

Appendix

1/1

Additional product data

EPOS ActiveGard® technology

Protects users against acoustic injury caused by sudden sound burst on the line

EU Noise at Work limiter*

Enhanced audio protection preventing listening fatigue, average 85 dB over a workday

EPOS Voice™ technology

For a clear and natural listening experience

Sound pressure

Limited by EPOS ActiveGard®:
Max. 103 dB via ED
Max. 110 dB via ED (SC 238 / SC 268)
Max. 113 dB via USB

Optimized for communication & multimedia**

Sound enhancement profiles adjust automatically for optimal communication or multimedia

In-line call control**

Answer/end call,
Volume up/down
Microphone mute
Redial last outgoing call

* In compliance with EU Noise at Work legislation (Directive 2003/10/EC), that sets limits for two types of noise in the workplace: Acoustic burst and Sustained noise.

** Available on the USB MS II variants