



www.cougargaming.com

VORTEX ^{RGB}

FCB 120

COOLING KIT

LET IT SHINE!

REAL GEAR FOR REAL GAMERS

REAL GEAR FOR REAL GAMERS

TRI-DIRECTIONAL LIGHTING

In, Front, Out. The VORTEX RGB FCB 120 fans' 18 LEDs produce a visual spectacle in three directions. While most other backlit fans project their light only inward and forward, VORTEX RGB FCB 120 gives you a 180° viewing angle, covering all the area visible from outside your PC case.

PRESET LIGHTING EFFECTS + MOTHERBOARD SYNCHRONIZATION

The included COUGAR Core Box C, which supports up to 8 fans and 4 RGB LED strips, allows you directly control its 14 preset lighting effects with an included switch or with your case's reset button. You can also connect it to compatible motherboards' 5V RGB header for system-wide synchronization!

SUPPORT FOR DIRECT MOTHERBOARD CONNECTION

Connect the COUGAR Core Box C directly to the 5V RGB connectors of compatible ASUS, MSI or GIGABYTE motherboards for system-wide synchronization and full customization.

* Please note: Only 5V addressable header from compatible motherboards are supported; please do not connect the COUGAR Core Box C to a 12V Non-addressable header.

▲ Core Box C for up to 8 fans and 4 LED strips, with 3 VORTEX RGB FCB 120 Fans included.

▲ The electrical consumption of a fully installed COUGAR Core Box C with 8 COUGAR VORTEX RGB fans and 4 COUGAR RGB LED strips is 40W (5V); please take this into account when choosing your power supply and designing your build.

FEATURES**ENGLISH**

- 18 RGB LEDS PER FAN + TRI-DIRECTIONAL LIGHTING DESIGN
- CORE BOX C SUPPORT 5V ADDRESSABLE HEADER TO COMPATIBLE MOTHERBOARDS
- PATENTED COUGAR FAN DESIGN THAT OPTIMIZES AIRFLOW

DEUTSCH

- 18 RGB-LEDS PRO LÜFTER + TRIDIREKTIONALES BELEUCHTUNGSDESIGN
- CORE BOX C UNTERSTÜTZEN 5-V-RGB-VERBINDUNG MIT KOMPATIBLEN MOTHERBOARDS
- PATENTIERTES COUGAR-LÜFTERDESIGN, DAS DEN LUFTSTROM OPTIMIERT

РУССКИЙ

- 18 RGB-НАОТ АЕІ АІ А А ЕА/ЕАІ І ААІ ОЕЕОТ ДА + ОДОАНОІ ДІ ІІ ЕЕ АЕСАЕІ ІІ ААААЕЕ
- CORE BOX C ІІ АААД/ЕАААА 5V ІІ АЕЕД/ХАІ ЕА RGB Е ІІ АІ АНОЕІ ОІ І АОДЕІ НЕЕІ І ЕАОАІ
- ЧАІ АДАІ ОІ ААІ І ОЕ АЕСАЕІ ААІ ОЕЕОІ ДІ АІ COUGAR ІІ ОЕІ ЕЧАОЕАЕ АІ ЧАОЗІ ОО ІІ ОІ ЕІ А

HUNGARIAN

- 18 RGB LED-LÁMPA MINDEN VENTILÁTORHOZ + HÁROMIRÁNYÚ VILÁGÍTÁS
- CORE BOX C TÁMOGATJAK AZ 5 V-OS RGB-CSATLAKOZÁST A KOMPATIBILIS ALAPLAPOKKAL
- SZABADALMAZTATOTT COUGAR VENTILÁTORRAL TORTENŐ KIALAKÍTÁS, AMELY OPTIMALIZÁLJA A LEGÁRAMLATOT

PORTUGUÊS

- 18 LEDS RGB POR VENTILADOR + DESIGN DE ILUMINAÇÃO TRI-DIRECIONAL
- SUPORTE CORE BOX C 5V RGB CONEXÃO A PLACAS MÃE COMPATIVAS
- DESIGN DE VENTILADOR COUGAR PATENTEADO QUE OTIMIZA O FLUXO DE AR

ESPAÑOL

- 18 LEDS RGB EN CADA VENTILADOR + DISEÑO DE ILUMINACIÓN TRIDIRECCIONAL
- CORE BOX C SOPORTA CONEXIÓN A PUERTOS RGB DE 5V EN PLACAS MADRE COMPATIBLES
- VENTILADORES CON DISEÑO PATENTADO QUE OPTIMIZA EL FLUJO DE AIRE

FRANÇAIS

- 18 LED RVB PAR VENTILATEUR + ÉCLAIRAGE À CONCEPTION TRIDIRECTIONNELLE
- CORE BOX C RACCORDEMENT RVB 5V SUR LES CARTES MÈRES COMPATIBLES
- VENTILATEUR À CONCEPTION COUGAR BREVETÉE QUI OPTIMISE LE FLUX D'AIR

POLISH

- 18 DIOD RGB NA WENTYLATOR + OŚWIETLENIE TRÓJKIERUNKOWE
- CORE BOX C OBSŁUGUJĄ POŁ. CZENIE 5V RGB W KOMPATYBILNYCH PŁYTKACH GŁÓWNYCH
- OPATENTOWANA KONSTRUKCJA WENTYLATORA COUGAR ZAPEWNIAJĄCA OPTIMALIZACJĘ PRZEPŁYWU POWIETRZA

ITALIANO

- 18 LED RGB PER OGNI VENTOLA + DESIGN LUMINOSO TRIDIREZIONALE
- CORE BOX C SUPPORTANO LA CONNESSIONE RGB 5V SULLE SCHEDE MADRI COMPATIBILI
- SISTEMA BREVETTATO COUGAR PER UN FLUSSO D'ARIA OTTIMIZZATO

中文

- 每个风扇有18颗RGB LED灯 + 3向背光设计
- CORE BOX C 支援 5V RGB 连接 相容主机板
- COUGAR 风扇专利设计有效优化气流运行效果

日本語

- ファンは18 個のRGB LED搭載 + 3パターンでのライティング効果
- CORE BOX C 互換性のあるマザーボードの5V RGBコネクタとの接続により、連動してのライティングが可能
- エアフローを最適化する特許取得済みの COUGARファン設計

한국어

- 팬당 18 개의 RGB LED + 3 방향 조명 디자인
- 호환 마더 보드에 5V RGB 연결을 지원하는 CORE BOX C
- 공기 흐름을 최적화하는 특허받은 COUGAR 팬 디자인

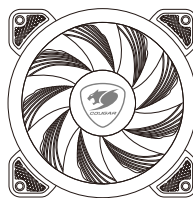
CONTENTS

VORTEX RGB FCB 120 x 3



Core Box C

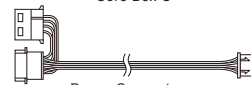

Power Connector



Lighting Switch Cable

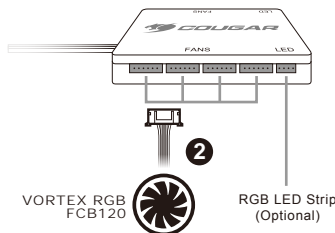
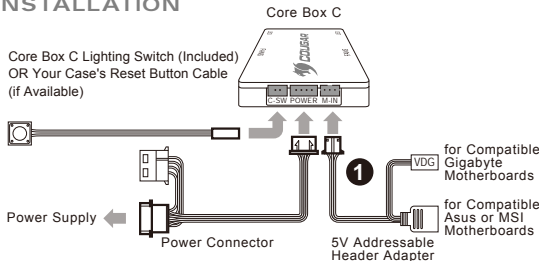

5V Addressable Header Adapter

INSTALLATION

▲ Core Box C for up to 8 fans and 4 LED strips, with 3 VORTEX RGB FCB 120 Fans included.

TWO WAYS TO CONTROL YOUR RGB LIGHTING

1. Connect Your Case's Reset Button to the Core Box C and Use It to Change Lighting Modes.

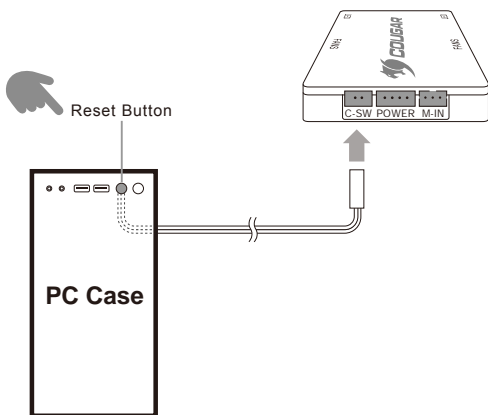

2. Use the Included Lighting Switch Cable.

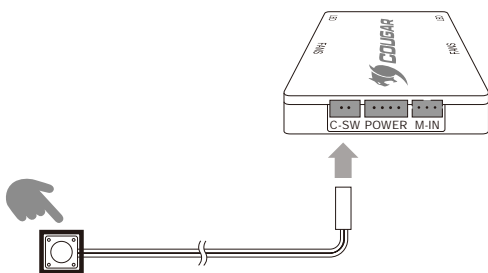

CORE BOX C ORDER OF THE 14 PRESET LIGHTING EFFECTS

Flow	>	Swift	>	Breathing	>	Red	>	Orange	>
Yellow	>	Green	>	Yellow-green	>	Blue	>	Sky-blue	>
Purple	>	Fuchsia	>	White	>	Pink	>	Lighting Off	

HOW TO SWITCH BETWEEN RGB CONTROL MODES

Press and hold the switch for three seconds to switch between RGB control modes.

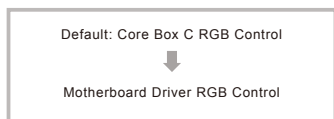

FAN SPECIFICATIONS

Dimension	120 x 120 x 25mm
Bearing	Hydraulic-Bearing
Speed	1200 R.P.M
Air Flow	36.72 CFM 62.36 m3/h
Air Pressure	0.78mm H2O
Fan Voltage	12 VDC
LED Voltage	5 VDC
Acoustical Noise	24.3 dBA
Cable Length	600mm
LED Lights	18
LED Power consumption	1.8W

The above specifications may vary by country or region

PACKAGE CONTAINS

VORTEX RGB FCB120 x 3
Core Box C & Power Connector
5V Addressable Header Adapter
Lighting Switch Cable
Fan Screws
User Manual

GLOBAL WARRANTY POLICY

WARRANTY PERIODS OF COUGAR GAMING DEVICES

Product : COUGAR VORTEX RGB FCB120 COOLING KIT

Warranty : 1 Year

This warranty gives you specific legal rights. You may also have other rights granted under local law. These rights may vary.

WARRANTY AGREEMENT

- If the product has defects in material or manufacture, COUGAR will provide product repair and replacement service within the warranty period.
- Our warranty service is based on the date of the invoice or warranty card (must be affixed with the store stamp).
- If you lose the aforementioned evidence, we will apply the original shipping date of the product as the beginning date of warranty period. The shipping date will be identified by the product serial number(S/N).

CONDITIONS WHERE FREE MAINTENANCE IS NOT PROVIDED

- Any fault or damage caused by natural disasters (including storm, fire, flood, thunder, earthquake, etc).
- Any fault or damage caused by accidental factors and man-made reasons (including hit, scrape, crash, moving, compression, stain, corrosion, use of incurred on unsuitable voltage, computer virus, riot, misuse, malicious damage, etc).
- Use in an improper operating environment (including high temperature, high humidity, water inflow, etc).
- Inability to provide the product warranty card, purchase receipt or invoice to prove the product is still within the warranty period and the shipping date of the product is out of warranty.
- The warranty card or product serial number has been altered or its number is hard to identify.
- The warranty period has expired.
- Any fault or damage caused by non-compliance with regulations stated on the user manual or improper, rough and careless treatment.
- Any fault or damage caused by use of parts not certified by COUGAR original manufacturer.
- The problem is caused by improper repair or adjustment by the buyer or any manufacturer without authorization from COUGAR.
- The product is not acquired from an authorized distributor of the company or is acquired from illicit sources.
- Paper carton, instruction and other accessories are not warranted.

DISCLAIMERS

- COUGAR product is not authorized for use as critical components in life support device or for incorrect application software or malfunction of the product.
- COUGAR is not liable for the death or damage of person or loss of property when product is using as, including but not limited to, medical equipment, military equipment, traffic equipment and disaster prevention system.
- COUGAR is not liable for any damages, expenses, lost data, lost revenues, lost savings, lost profits, or any incidental or consequential damages due to using defect product of COUGAR.
- If you have any question about the warranty, please feel free to contact us. Customer support: <https://cougargaming.com/support/contact/upload/>

LEGAL NOTICES

This manual was created by Compucase Enterprise and may not be completely or partially copied, passed on, distributed or stored without written consent by Compucase Enterprise. COUGAR® is a registered brand of Compucase Enterprise. Other product and company names mentioned in this documentation may be brands or trademarks of their respective owners. Compucase Enterprise reserves the right to make changes concerning the contents of the manual and the technical data of the product without previous announcement.



All other registered trademarks belong to their respective companies.

MANUFACTURER CONTACT

Compucase Enterprise Co.,Ltd.
No. 225, Lane 54, An Ho Road Sec. 2 Tainan,
Taiwan, R.O.C
Tel:+ 886-6-356-0606

COUGAR USA Technical Service
Tel: (833) 256-3778
Mail: rma@compucaseusa.com

Service email : <https://cougargaming.com/support/contact/upload/>

More information you will find at cougargaming.com

Compucase Enterprise Co.,Ltd.

All rights reserved.
Made in China

ДАТА ИЗГОТОВЛЕНИЯ ПРОДУКЦИИ

год и месяц изготовления продукции указаны в серийном номере продукта. (существует 2 способа определения даты изготовления, оба способа описаны ниже)

A После S/N: первые две цифры означают год, вторые две – месяц изготовления. Например, S/N: H1702000001 означает, что товар был произведен в феврале 2017 года.

B После S/N: если указаны буквы, то две буквы представляют цифры из таблицы ниже, и означают год, последующие две цифры – месяц изготовления. Например, S/N: DAG02REV1000001 означает, что товар был произведен в феврале 2017 года.

A	B	C	D	E	F	G	H	I	J
1	2	3	4	5	6	7	8	9	0

• Например, AG = 17 = 2017 год