

Kensington®

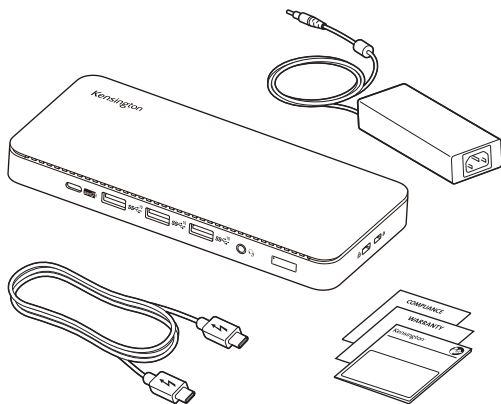

SD4839P USB-C Triple Video Driverless Dock



US



EU

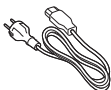

UK



ANZ/CN



JP



[kensington.com/register](https://www.kensington.com/register)

1

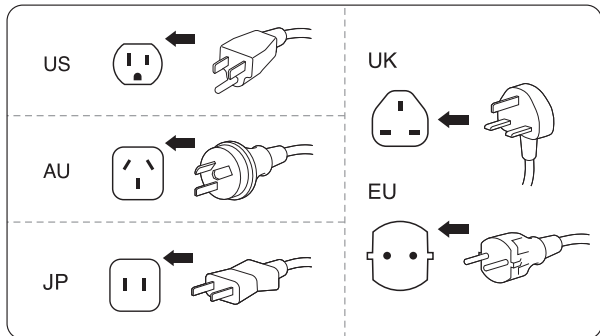
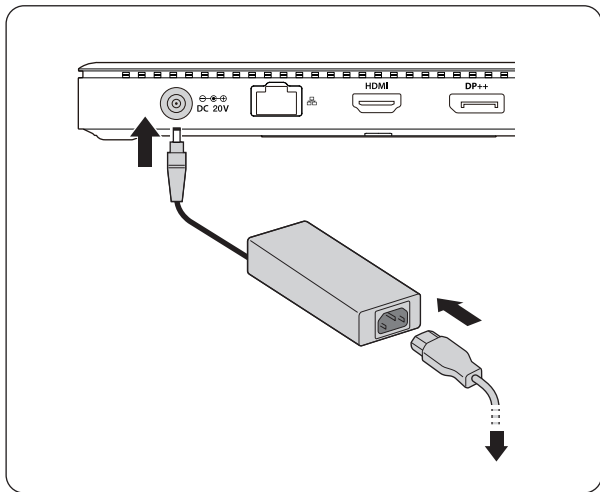

2

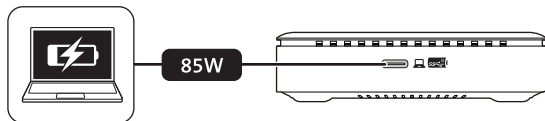
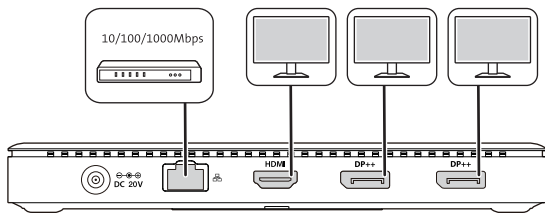
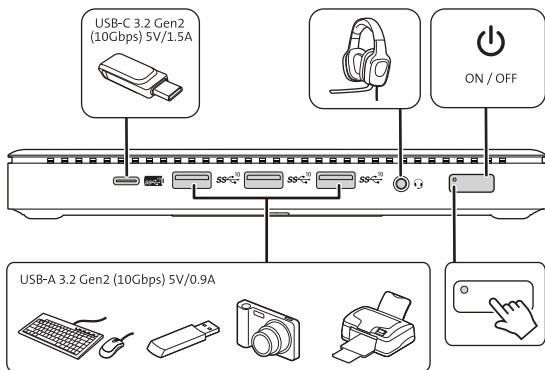

3

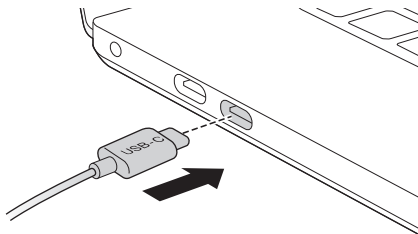



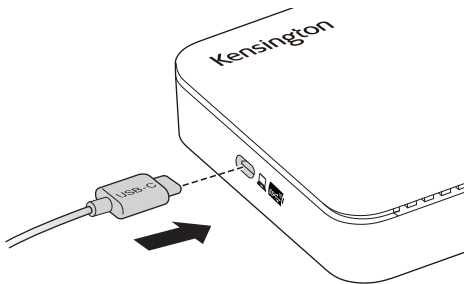



4







5



		
	DP1.2	DP1.4 (DSC ON)
	4K @ 30Hz	4K @ 60Hz

		
	DP1.2	DP1.4 (DSC ON)
	1080p @ 60Hz	4K @ 60Hz
	1080p @ 60Hz	4K @ 30Hz(DP)
		4K @ 30Hz(HDMI)

			
	DP1.2	DP1.4 (DSC ON)	
 DP++	1080p @ 30Hz	4K @ 30Hz (first come, first serve)	1080p @ 60Hz
 DP++	1080p @ 30Hz	4K @ 30Hz (first come, first serve)	1080p @ 60Hz
 HDMI	1080p @ 30Hz	1080p @ 60Hz	4K @ 30Hz (first come, first serve)

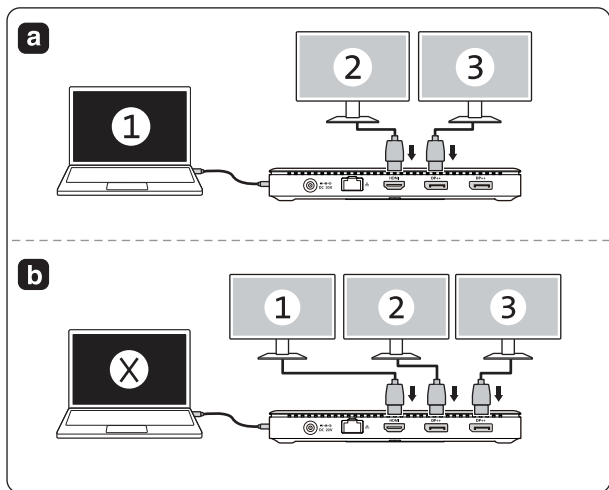

Sold separately

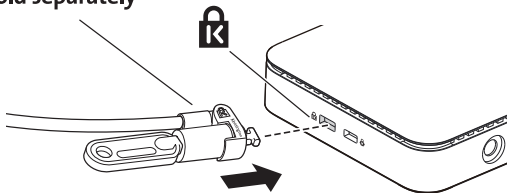

Recommended
K65020WW MicroSaver® 2.0 Keyed Lock

Sold separately

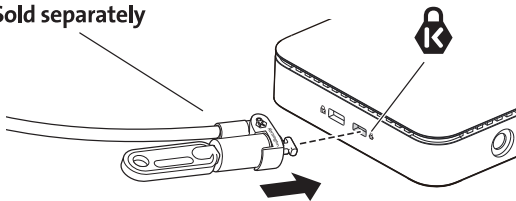

Recommended
K64444WW NanoSaver™ Keyed Laptop Lock

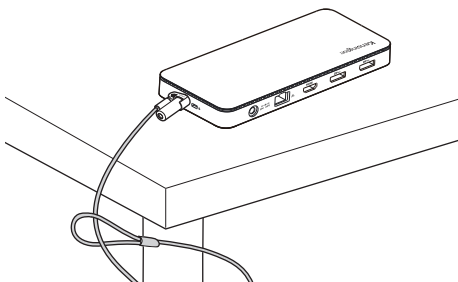



www.kensington.com/support

Kensington, Security Slot and ACCO are registered trademarks of ACCO Brands. Windows is a registered trademark of Microsoft Corporation in the U.S. and/or other countries. USB-C is a trademark of USB Implementers Forum. All other trademarks are the property of their respective owners.

©2022 Kensington Computer Products Group, a division of ACCO Brands.

この装置は、クラスB機器です。この装置は、住宅環境で使用することを目的としていますが、この装置がラジオやテレビジョン受信機に近接して使用されると、受信障害を引き起こすことがあります。

取扱説明書に従って正しい取り扱いをして下さい。

VCCI - B

