



User Guide

4G LTE Mobile Wi-Fi
M7350

Contents

About This Guide	1
Chapter 1. Get to Know About Your Mobile Wi-Fi	2
1. 1. Product Overview	3
1. 2. Physical Description	4
1. 2. 1.The Exterior	4
1. 2. 2.The Interior	6
Chapter 2. Set Up Internet Connection	7
2. 1. Install the Hardware	8
2. 1. 1.Installation	8
2. 1. 2.Power On	9
2. 2. Connect to the Mobile Wi-Fi	10
Chapter 3. Login	16
3. 1. Via Phone Login Entry	17
3. 2. Via PC Login Entry	17
3. 3. Via tpMiFi App	19
Chapter 4. Manage Your Data Usage	20
4. 1. Track Data Usage	21
4. 1. 1.Check Data Usage on Screen	21
4. 1. 2.Check Data Usage on the Web Management Page	21
4. 1. 3.Check Data Usage via SMS	22
4. 1. 4.Revise Data Usage	23
4. 2. Limit Data Usage	24
4. 2. 1.Limit Data Package	24
4. 2. 2.Limit Monthly Data Usage	25
4. 3. Setup Free Data Period	26
4. 4. Enable Mobile Data	27
4. 5. Enable Data Roaming	27
Chapter 5. Secure Your Network	29

5. 1.	Secure Wireless Network.....	30
5. 2.	Block Unwelcome Devices.....	31
5. 3.	Lock SIM Card.....	32

Chapter 6. Share Files on SD Card..... 35

6. 1.	Access via Wi-Fi Mode.....	36
6. 2.	Access via USB Mode.....	41

Chapter 7. Customize Your Network..... 43

7. 1.	Specify Network Mode.....	44
7. 2.	Specify Network Band.....	44
7. 3.	Configure Dial-up.....	45
	7. 3. 1.Configure Dial-up Settings.....	45
	7. 3. 2.Configure Network Search.....	46
7. 4.	Configure DHCP Server.....	47

Chapter 8. Manage Your Mobile Wi-Fi..... 49

8. 1.	Save the Mobile Wi-Fi's Power.....	50
8. 2.	Change Admin Account.....	51
8. 3.	Set Up System Time.....	52
8. 4.	Restore Configuration Settings.....	52
8. 5.	Update the Firmware.....	53
8. 6.	Update ISP Parameters.....	54
8. 7.	System Log.....	55

FAQ..... 57



About This Guide

This guide is a complementation of Quick Installation Guide. The Quick Installation Guide instructs you on quick internet setup, and this guide provides details of each function and shows you the way to configure these functions appropriate to your needs.

When using this guide, please notice that features of the Mobile Wi-Fi may vary slightly depending on the model and software version you have, and on your location, language, and internet service provider. All screenshots, images, parameters and descriptions documented in this guide are used for demonstration only.

Conventions

In this guide the following conventions are used:

Convention	Description
<u>Underlined</u>	Underlined words or phrases are hyperlinks. You can click to redirect to a website or a specific section.
Teal	Contents to be emphasized and texts on the web page are in teal, including the menus, items, buttons and so on.
>	The menu structures to show the path to load the corresponding page. For example, Advanced > Wireless > Black List means the Black List page is under the Wireless menu that is located in the Advanced tab.
 Note:	Ignoring this type of note might result in a malfunction or damage to the device.
 Tips:	Indicates important information that helps you make better use of your device.

More Info

The latest software, management app and utility can be found at [Download Center](#) at www.tp-link.com/support.

The Quick Installation Guide can be found in the same place you found this guide or inside the package of the Mobile Wi-Fi.

Specifications can be found on the product page at <http://www.tp-link.com>.

A Technical Support Forum is provided for you to discuss our products at <http://forum.tp-link.com>.

Our Technical Support contact information can be found at [Contact Technical Support page](#) at www.tp-link.com/support.

Chapter 1

Get to Know About Your Mobile Wi-Fi

This chapter introduces what the Mobile Wi-Fi can do and its appearance.

It contains the following sections:

- [Product Overview](#)
- [Physical Description](#)

1.1. Product Overview

The Faster Connections, The More You Can Do

Just insert a 4G SIM card to create your reliable personal Wi-Fi hotspot and share instant 4G/3G connectivity with friends. The Mobile Wi-Fi, supporting the latest generation 4G LTE network, can reach a faster download speed so that users can enjoy HD movies without interruption, download files in seconds, and hold a video chat without dropouts.

Artful Little Gadget and Built-in Battery for Life on the Go

The TP-Link Mobile Wi-Fi features a compact, elegant design and built-in powerful battery very suitable for travel, business trips and outdoor activities. With added flexibility, the device can be charged via a micro USB cable connected to an adapter, laptop or portable charger for endless hours of 4G sharing.

Easy Management with the tpMiFi App

With the tpMiFi App, you can conveniently access and manage the Mobile Wi-Fi right on your iOS/Android devices. The tpMiFi app allows you to set data limits, control which devices can access your Wi-Fi, send messages, and share media files to/from a removable micro SD card.

1.2. Physical Description



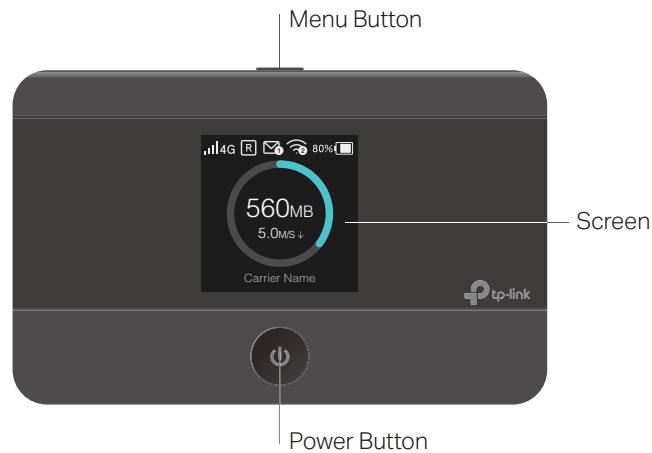



1.2.1. The Exterior



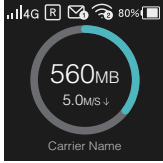





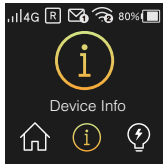

Button Explanation

Button	Description
Menu Button	<ul style="list-style-type: none"> • Press this button to enter the Menu Screen from the Home Screen. • Press this button to switch the icons or options. • Press this button to light on the screen.
Power Button	<ul style="list-style-type: none"> • Press and hold this button to power on or off the Mobile Wi-Fi. • Press this button to light on or off the screen. • Press this button to select the icon or option.

Screen Display

Home Screen	Displayed Item	Indication
		Indicates the signal strength of the current network.
	4G/3G/2G	Indicates successful network connection and the current network type: 4G, 3G or 2G.
		Indicates you are in roaming service.
		Indicates that there is un-read message(s) and the number of un-read messages.
		Displays the Wi-Fi status and the number of current wireless clients.
	100% 	Displays the remaining battery power.
	560MB	Indicates the total data used. It will be cleared after the Mobile Wi-Fi is reset.
	5.0 M/S ↓	Indicates the download speed of current data transmission.

Menu Screen	Menu	Description
	 Home	Displays the information of data, signal strength, battery life and so on.
	 Device Info	Displays the SSID (network name), password and login address of the Mobile Wi-Fi.
	 Power Saving	To turn on or off the power saving mode. If enabled, the Wi-Fi will be shut down if no clients are connected to the Mobile Wi-Fi for a period of time (10 minutes by default). You can also save power by changing the Wi-Fi range on Advanced > Power Saving of the web management page.
	 WPS	To enable the WPS function. Enable this function and immediately press the WPS button on your client device. A success message will appear on the screen, indicating successful WPS connection.
	 Wi-Fi Band	To change the Wi-Fi band to 2.4GHz or 5GHz as needed.
	 Network Mode	To change the network mode to 4G preferred, 4G only or 3G only as needed.
	 Data Roaming	To enable or disable the Data Roaming function as needed. We recommend you to enable it on when you are out of the carrier service area.
	 App Download	Displays the QR code of the TP-Link tpMiFi app that helps you manage your Mobile Wi-Fi. Scan it to download the app.

1.2.2. The Interior

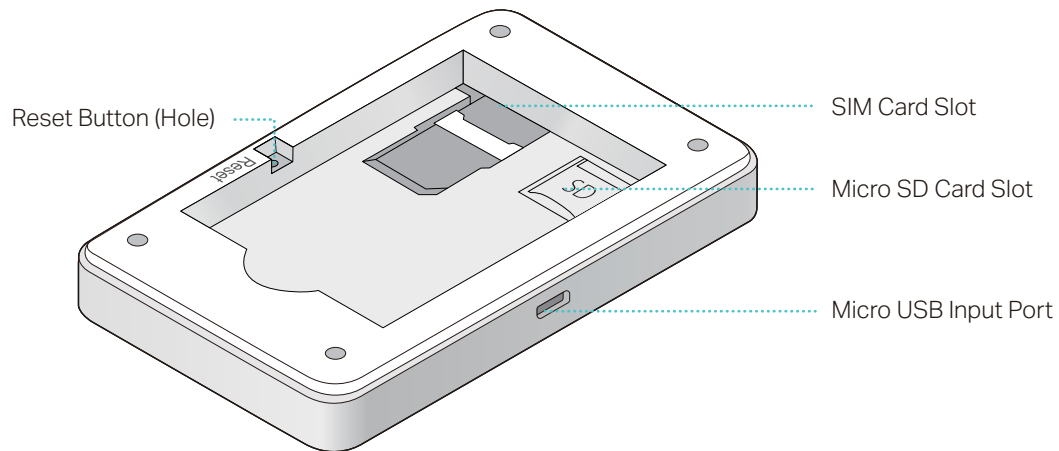

Item	Description
SIM Card Slot	Insert the SIM card into the slot. A nano or micro SIM card must be converted using a SIM card tray.
Micro SD Card Slot	Slide and lift up the slot cover, insert your SD card and slide the cover back to lock. The inserted SD card can be used for storage and media sharing.
Micro USB Input Port	Plug in the USB cable to this port to charge your Mobile Wi-Fi or share SD card contents.
Reset Button (Hole)	With the Mobile Wi-Fi powered on, use a pin to press and hold this button (hole) until "Power Off" appears on the screen to reset the Mobile Wi-Fi.

Chapter 2

Set Up Internet Connection

This chapter introduces how to install the hardware and set up the Internet connection of your Mobile Wi-Fi.

It contains the following sections:

- [Install the Hardware](#)
- [Connect to the Mobile Wi-Fi](#)

2. 1. Install the Hardware

2. 1. 1. Installation

1. Remove the cover and the battery.

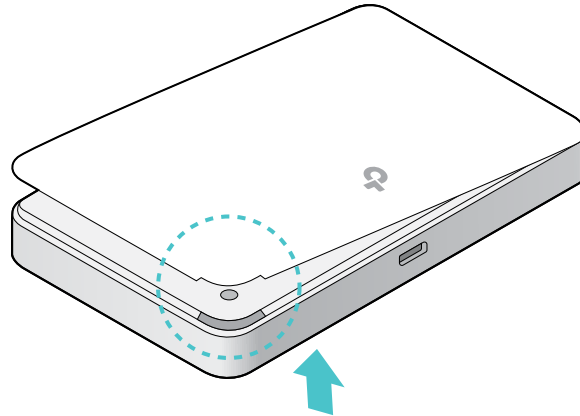

2. Insert the SIM card.

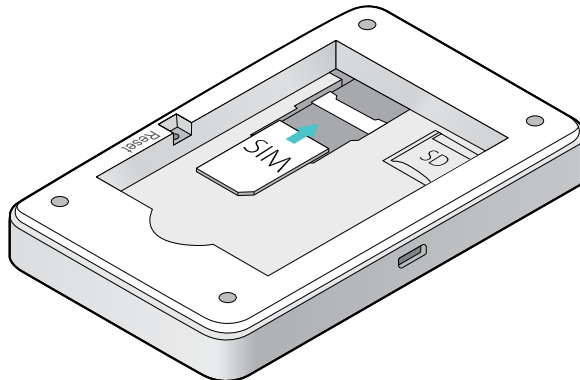

■ Note:

- A nano and micro SIM card must be converted using a SIM card tray.
- The SIM card is not provided by TP-Link.

3. Install the SD card if any. Slide and lift up the slot cover, insert the SD card and slide the cover back to lock. The inserted SD card can be used for storage and media sharing.

■ Note:

- The SD card is not provided by TP-Link.

4. Fit the battery into the slot as shown below.

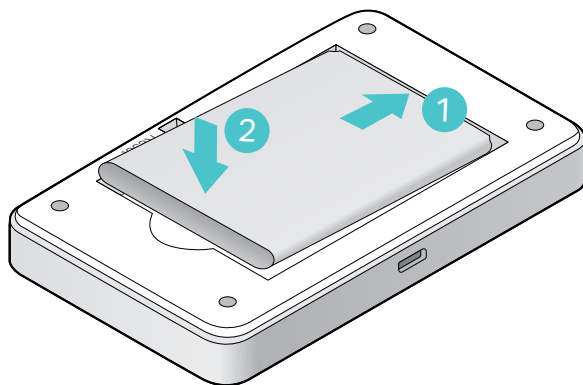

5. Replace the cover.

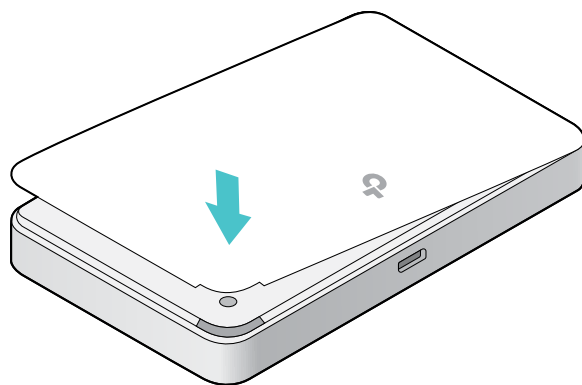

2.1.2. Power On

Press and hold  (power button) until the welcome screen appears.

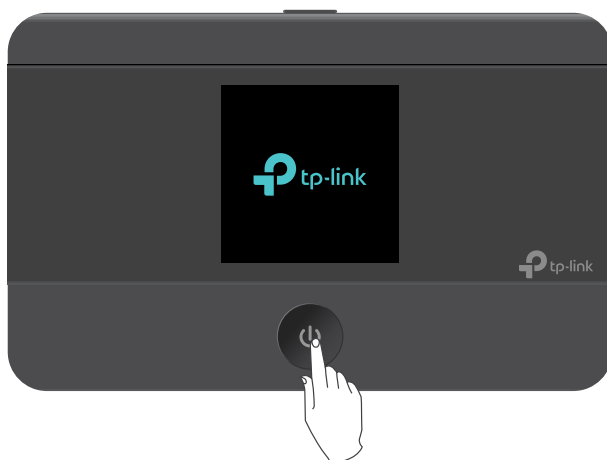

Note:

To power off, press and hold  (power button) until **Power Off** appears on the screen.

2.2. Connect to the Mobile Wi-Fi

1. After the Mobile Wi-Fi is powered on, you will see the following screen.

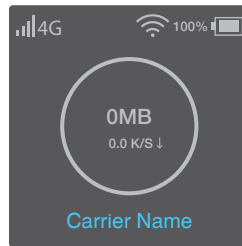

Note: If other messages appear on the screen, please refer to Q2 of FAQ .

2. Follow the instructions to connect to the Mobile Wi-Fi. Here are two methods.

Note: If you use a computer to connect to the Mobile Wi-Fi, please set it to obtain an IP address automatically.

Method One: Finding SSID and Password from the screen.

1) Press **MENU** (menu button) to enter the menu page and switch to the **Device Info** menu.



2) Press **⏻** (power button) to enter the **Device Info** page.

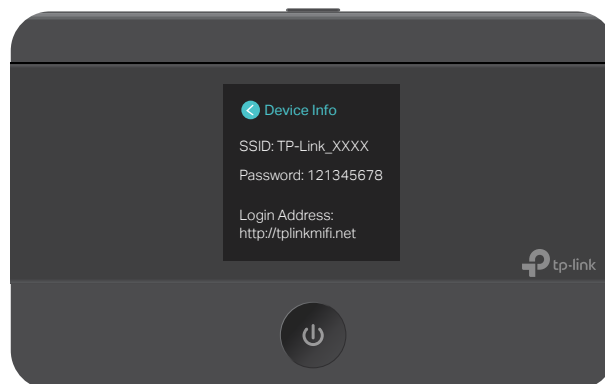

- 3) On your device, select the **SSID** and enter the **Wireless Password** which you find on the screen.

Method Two: Via WPS (Wi-Fi Protected Setup)

If you have a WPS-supported device (such as Android phones or tablets), you can connect to the Mobile Wi-Fi more easily using WPS button or PIN.

▀ Note:

The WPS function takes effect only when the SSID Broadcast function and wireless function are enabled.

- Via the WPS button

- 1) Press **MENU** (menu button) to enter the menu page and switch to the **WPS** menu.



- 2) Press **⏻** (power button) to enter the **WPS** page.

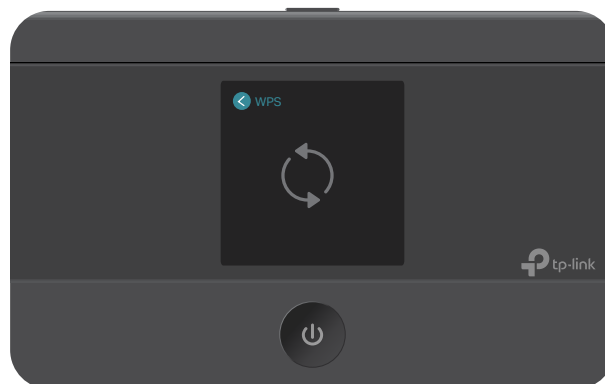

- 3) Press **MENU** (menu button) and **⏻** (power button) to enable the WPS function, and then the Mobile Wi-Fi starts to scan WPS-supported devices.

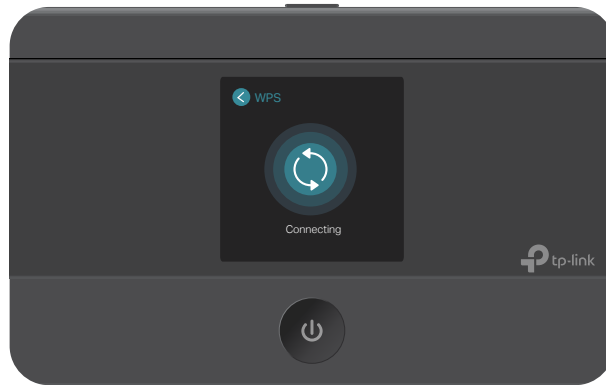

- 4) On your WPS-supported device, go to **Settings**, turn on **Wi-Fi**, and click **Connect via WPS** within 2 minutes.

Note:

The entry to the WPS function may differ from the example below and have different names on different devices.

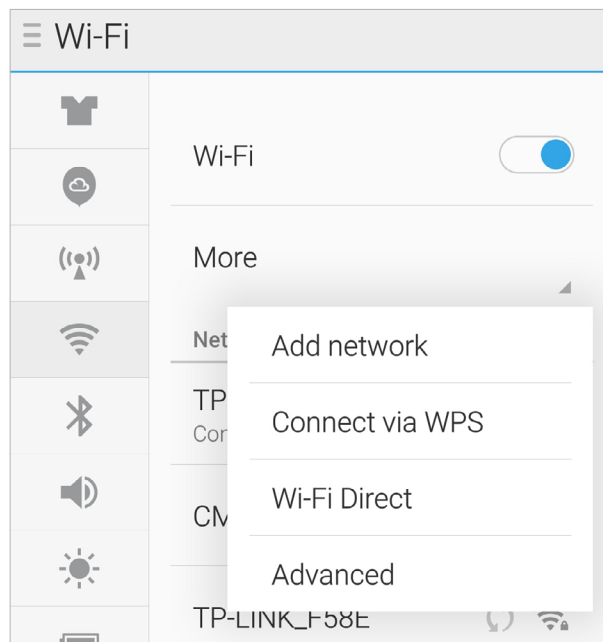

- 5) The status of WPS will change from **Connecting** to **Succeeded** after your WPS-supported device is connected to the Mobile Wi-Fi.

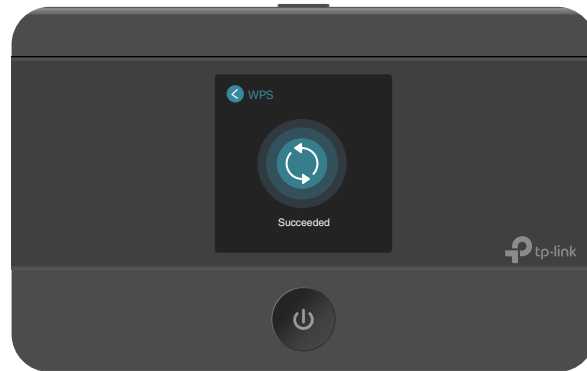

- Via the PIN
 - 1) On your WPS-supported device, go to [Settings](#), turn on [Wi-Fi](#), and go to the WPS page to get the PIN.

Note:

The entry to the WPS function may differ from the example below and have different names on different devices.

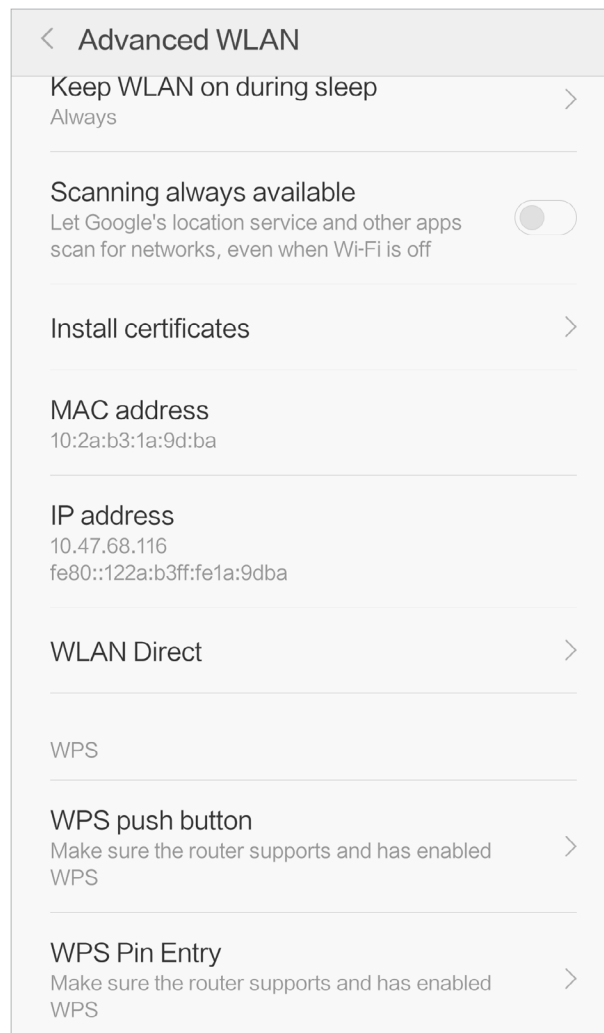

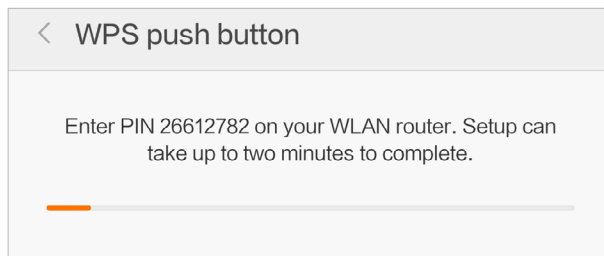

- 2) On another device already connected to the Mobile Wi-Fi, visit <http://tplinkmifi.net>, and log in with the default password: **admin**.

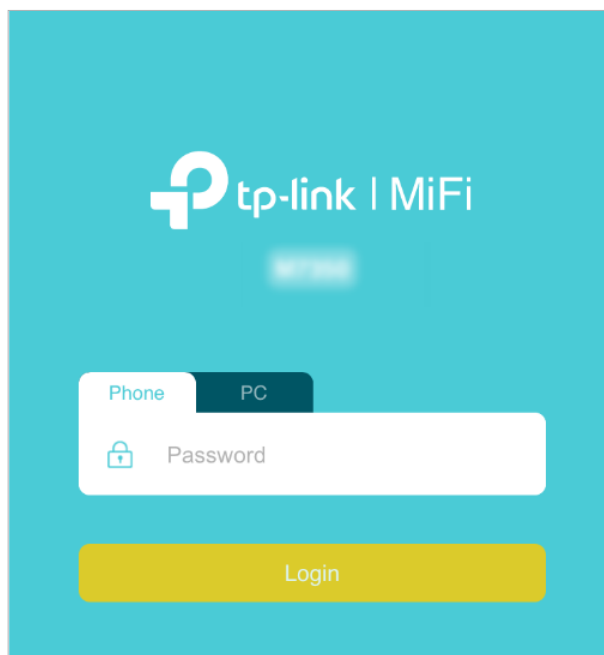

- 3) Go to **Device > Advanced > WPS**, check the **PIN** box and enter the PIN of your WPS-supported device in the field.

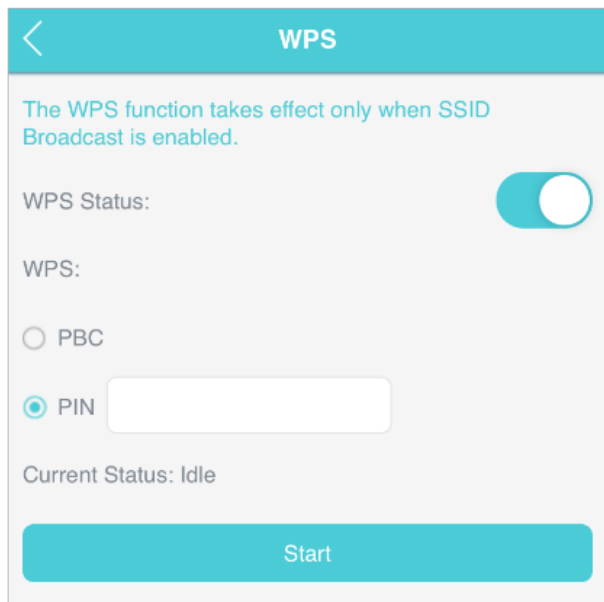

- 4) Click **Start** to start the WPS process, and the Current Status will change from **Idle** to **Succeed** after your WPS-supported device is connected to the Mobile Wi-Fi.

Chapter 3

Login

This chapter introduces how to log into the web management page of the Mobile Wi-Fi. Demonstrations in this guide use the phone web management page, while some use the PC web management page as those functions are only available on that platform.

Before login, make sure your device is connected to the Mobile Wi-Fi's SSID.

It contains the following sections:

- [Via Phone Login Entry](#)
- [Via PC Login Entry](#)
- [Via tpMiFi App](#)

3. 1. Via Phone Login Entry

1. Visit <http://tplinkmifi.net>, and log in with the default password: **admin**.

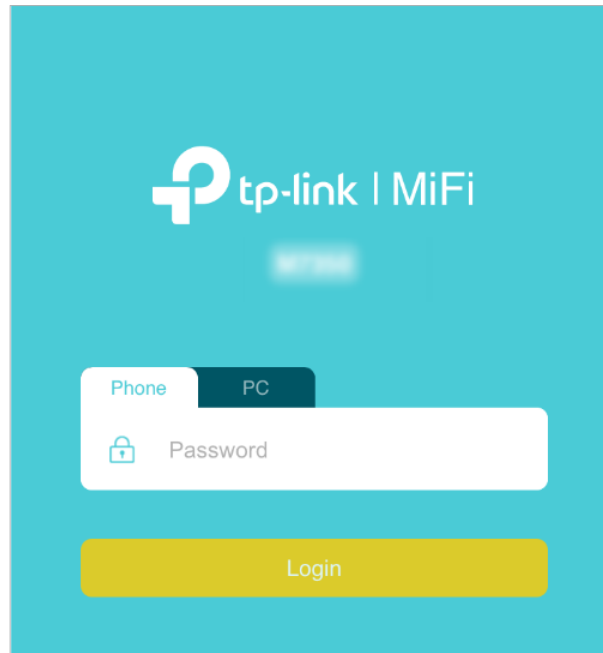

2. Create a new login password for security purposes and click **Done**.

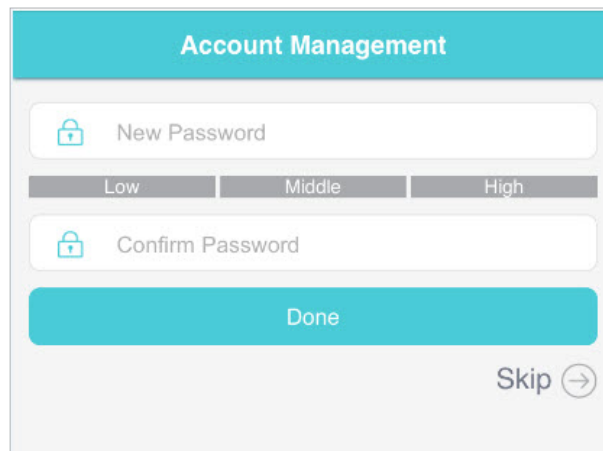

3. 2. Via PC Login Entry

The PC web management interface displays all features of the Mobile Wi-Fi. If you want to use a feature (such as Configure DHCP Server) the Phone web management interface or tpMiFi app does not have, please log in via the PC entry. Computer or tablet is recommended.

1. Visit <http://tplinkmifi.net>, and log in with the password: **admin**.

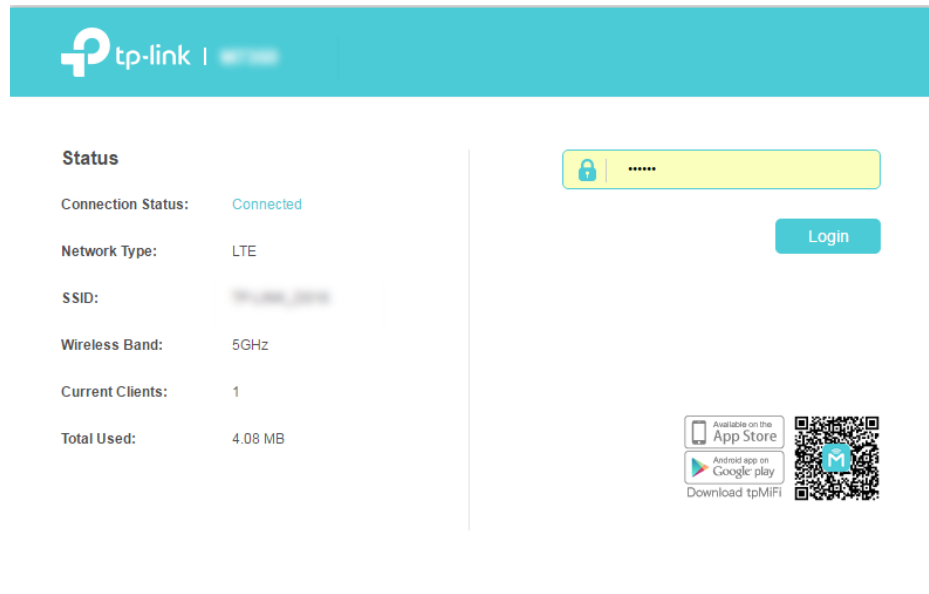

2. Go to [Wizard](#), create a new login password for security purposes and click [Confirm](#).

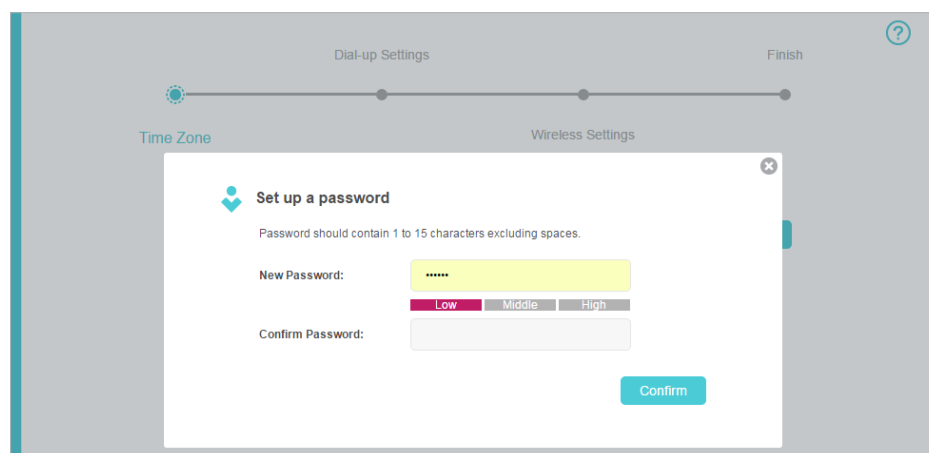

3.3. Via tpMiFi App

1. Search "tpMiFi" at the App Store or Google Play Store or simply scan the QR code to download the tpMifi app.



2. Connect your device to the Mobile Wi-Fi's SSID.
3. Launch the tpMiFi app, create a new password for security purposes and click [Save](#).

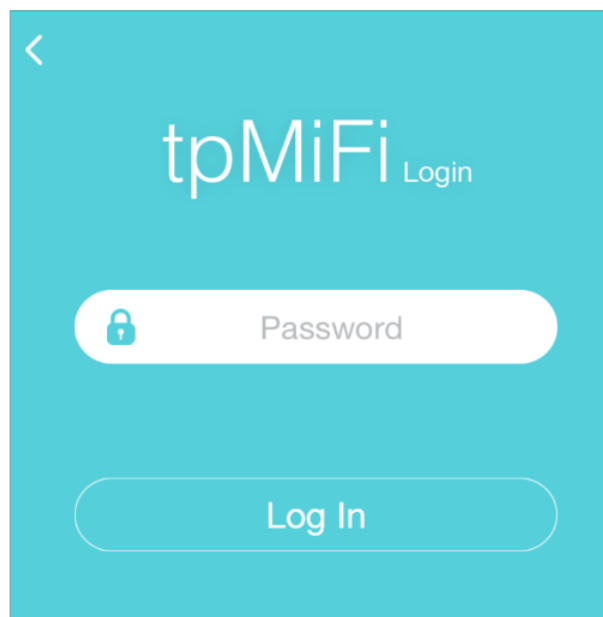

Chapter 4

Manage Your Data Usage

This chapter explains how to manage the data usage of your Mobile Wi-Fi.

It includes the following sections:

- [Track Data Usage](#)
- [Limit Data Usage](#)
- [Setup Free Data Period](#)
- [Enable Mobile Data](#)
- [Enable Data Roaming](#)

4. 1. Track Data Usage

This feature allows you to monitor the amount of data you have used on your Mobile Wi-Fi and revise the displayed data usage as needed.

4. 1. 1. Check Data Usage on Screen

You can view data usage on the screen of your Mobile Wi-Fi.

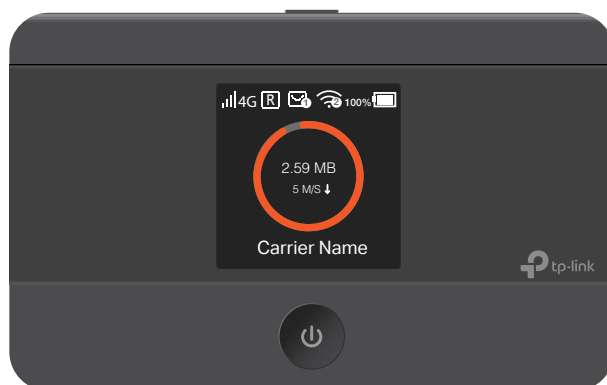

4. 1. 2. Check Data Usage on the Web Management Page

1. Visit <http://tplinkmifi.net>, and log in with the password you set for the Mobile Wi-Fi.
2. You can view the data usage on the [Status](#) page as shown below.

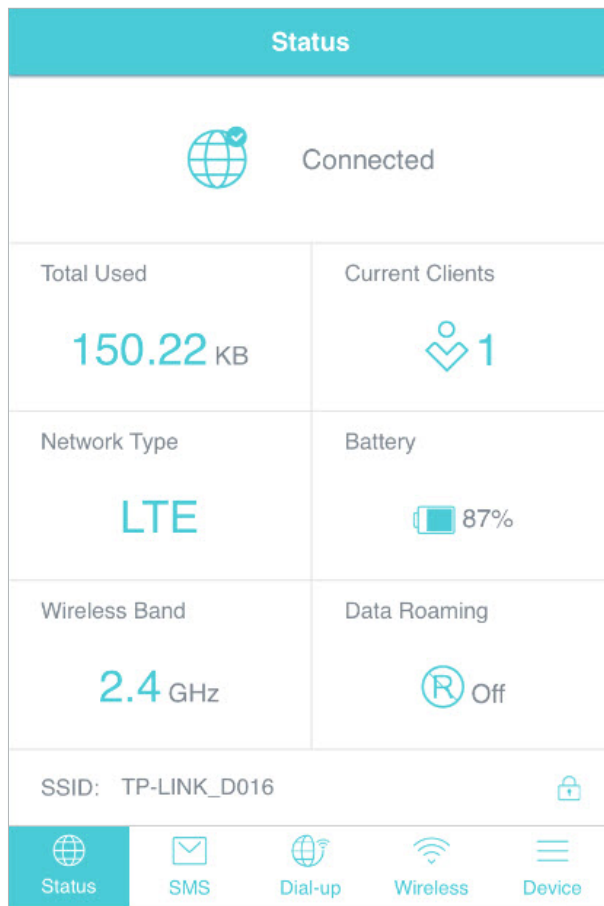

Note:

1. Actual data usage may vary from the estimated data usage displayed on the usage meter.
2. The page above displays the monthly data usage if you have enabled Monthly Data Statistics.

4. 1. 3. Check Data Usage via SMS

You can also obtain the data usage information by sending a message to the carrier of your SIM card, which is recommended if you need more accurate information.

1. Visit <http://tplinkmifi.net>, and log in with the password you set for the Mobile Wi-Fi.
2. Go to **SMS**.
3. Tap **New Message**.
4. Create a message to your carrier and then tap  to send it. For the phone number and message content, check from your carrier. Taking China Unicom as example, send CXLL to 10010 and you will receive a message about the data usage of your SIM card.

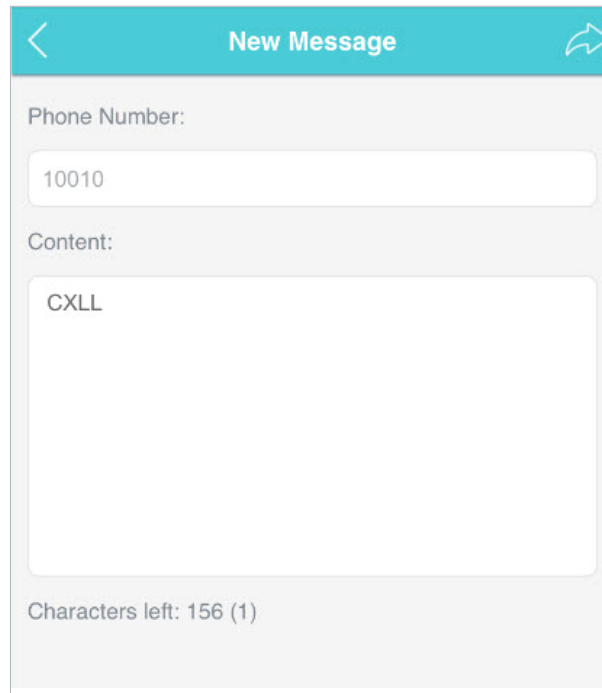

4. 1. 4. Revise Data Usage

If the data usage displayed is not accurate, you can modify it as needed.

1. Visit <http://tplinkmifi.net>, and log in with the password you set for the Mobile Wi-Fi.
2. Go to **Device** > **Data Usage Settings**.
3. The figure below displays the current data usage. Tap **Correct**, enter a more accurate value for the data usage and specify a unit of measure.

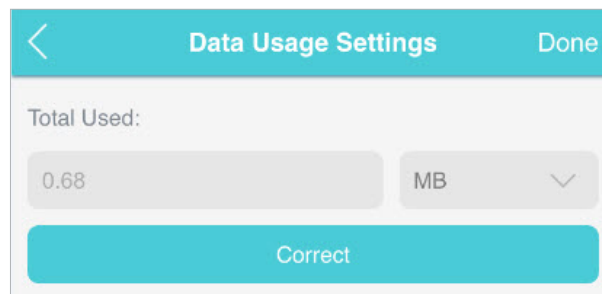

4. Tap **Done**.

■ **Note:**

1. You can check the exact data usage from your carrier.
2. The page above displays the monthly data usage if you have enabled Monthly Data Statistics.

4.2. Limit Data Usage



This feature allows you to establish data limits for different data packages so that you can better control your data usage.

4.2.1. Limit Data Package

I want to: Limit my data usage so that I will not exceed my data package (2GB). I wish to:

1. Receive an alert when the data usage reaches 1.8GB (90% of the allowance);
2. Disable the internet access automatically when it reaches the allowance (2GB).

How can I do that ?

1. Visit <http://tplinkmifi.net>, and log in with the password you set for the Mobile Wi-Fi.
2. Go to [Device > Data Usage Settings](#).
3. Enable [Data Usage Limit](#).
4. Enter [2](#) in [Total Allowance](#) field and specify [GB](#) as the unit of measure. To inform you that your data usage has reached the allowance, the Internet access will be disabled automatically and the data usage circle  on the Home Screen will turn to red.
5. Set [90](#) as the [Usage Alert](#) percentage. To inform you that your data usage has reached the alert value, the data usage circle  on the Home Screen will turn to orange.

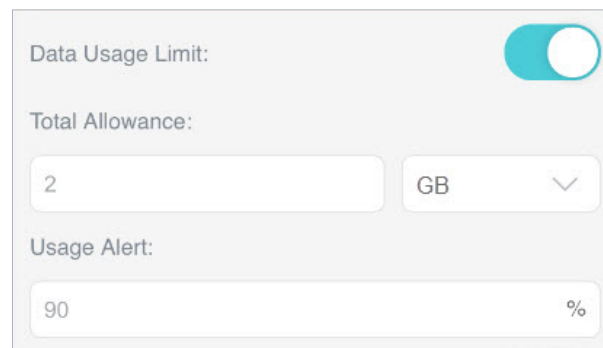

Data Usage Limit:

Total Allowance:

Usage Alert:

%

6. Tap [Done](#).

Done!



Now your data usage is limited according to your settings.

4.2.2. Limit Monthly Data Usage

I want to: Limit my data usage so that I will not exceed my monthly data package (800MB). I wish to:

1. Receive an alert when the data usage reaches 720MB (90% of the allowance);
2. Disable the internet access automatically when it reaches the allowance (800MB).

How can I do that?

1. Visit <http://tplinkmifi.net>, and log in with the password you set for the Mobile Wi-Fi.
2. Go to **Device > Data Usage Settings**.
3. Enable **Data Usage Limit** and **Monthly Data Statistics**.
4. Enter **800** in **Monthly Allowance** field and specify **MB** as the unit of measure. To inform you that your data usage has reached the allowance, the Internet access will be disabled automatically and the data usage circle  on the Home Screen will turn to red.
5. Set **90** as the **Usage Alert** percentage. To inform you that your data usage has reached the alert value, the data usage circle  on the Home Screen will turn to orange.
6. Enter the **Start Date**.

Note:

The monthly data usage statistics will be cleared and recounted from the day you have set every month.

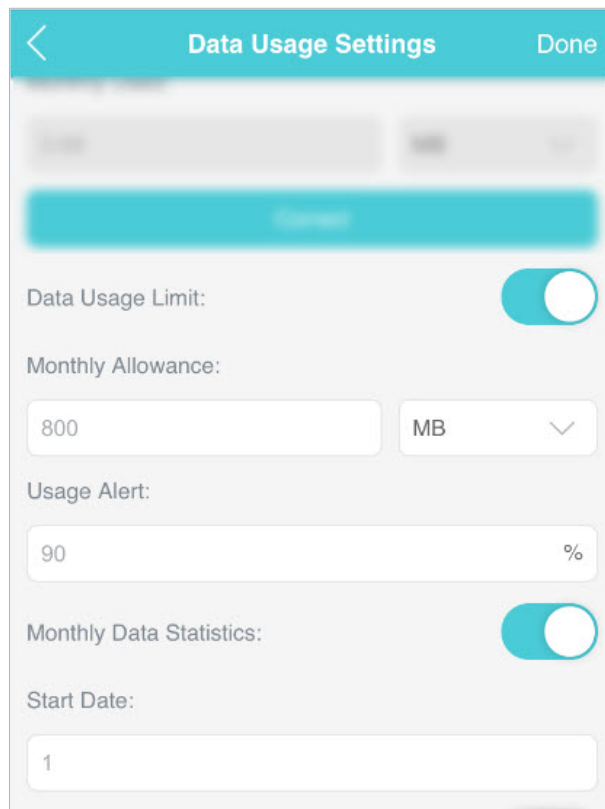

7. Tap **Done**.

Done!

Now your data usage is limited according to your settings.

4.3. Setup Free Data Period

Free Data Period is the time period when you will not be charged for data by your mobile carrier. If your mobile carrier has provided this data service, you can specify the free data period during which the data usage will not be counted for data alert and limitation.

1. Visit <http://tplinkmifi.net>, and log in with the password you set for the Mobile Wi-Fi.
2. Go to **Device > Data Usage Settings**.
3. Enable **Free Data Period**.
4. Enter the **Start Time** and **End Time** of Free Data Period.

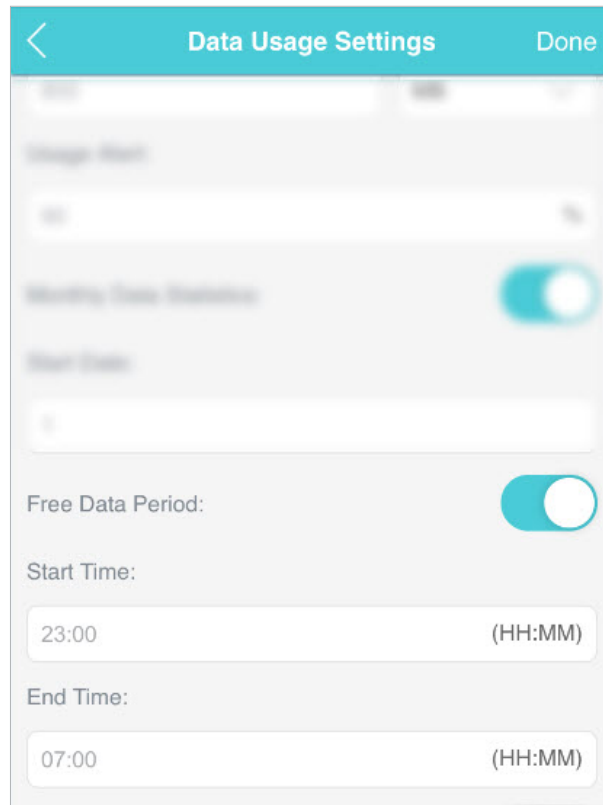

5. Tap **Done**.

4. 4. Enable Mobile Data

With Mobile Data (also known as cellular data) enabled, devices connected to the Mobile Wi-Fi can access the internet. This feature is enabled by default.

1. Visit <http://tplinkmifi.net>, and log in with the password you set for the Mobile Wi-Fi.
2. Go to **Dial-up**.
3. Enable **Mobile Data**.

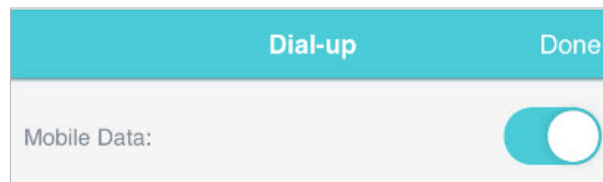

4. Tap **Done**.

4. 5. Enable Data Roaming

If you are out of your carrier service area, you can use this feature as needed.

1. Visit <http://tplinkmifi.net>, and log in with the password you set for the mobile Wi-Fi.
2. Go to **Dial-up**.
3. Enable **Data Roaming**.

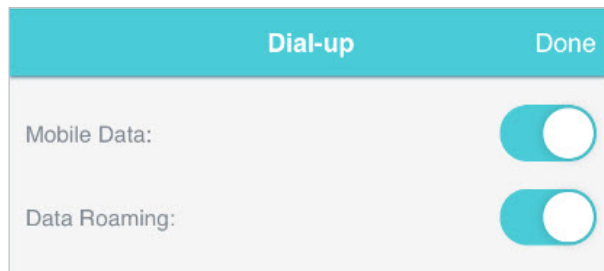

4. Tap **Done**.

Chapter 5

Secure Your Network

This chapter explains how to secure your network in various ways. You can change the SSID, manage the blacklist and lock your SIM card to safeguard your network.

It includes the following sections:

- [Secure Wireless Network](#)
- [Block Unwelcome Devices](#)
- [Lock SIM Card](#)

5.1. Secure Wireless Network

The SSID(wireless network name), wireless password of the Mobile Wi-Fi and security options are preset as default. The default SSID and password can be found on the screen of your Mobile Wi-Fi. You can customize the wireless settings as needed.

1. Visit <http://tplinkmifi.net>, and log in with the password you set for the Mobile Wi-Fi.

2. Go to [Wireless](#).

➤ **To change the SSID and wireless password:**

1. Enter a new SSID and wireless password in the [Wireless Network Name](#) and [Wireless Password](#) fields respectively.

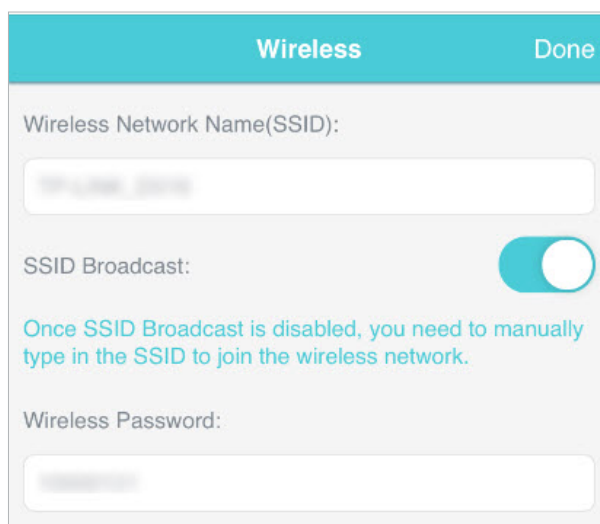

The screenshot shows the 'Wireless' settings screen. At the top, there is a teal header with the word 'Wireless' on the left and 'Done' on the right. Below the header, there are three main sections: 1. 'Wireless Network Name(SSID):' with a text input field containing 'TP-LINK_2016'. 2. 'SSID Broadcast:' with a teal toggle switch that is currently turned on. Below this toggle is a teal note: 'Once SSID Broadcast is disabled, you need to manually type in the SSID to join the wireless network.' 3. 'Wireless Password:' with a text input field containing a masked password.

2. Tap [Done](#).

➤ **To hide the SSID:**

1. Disable [SSID Broadcast](#), so the SSID will not be displayed when you scan for wireless networks.

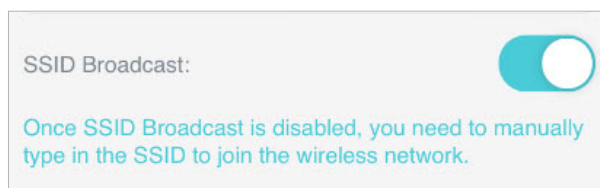

The screenshot shows the 'SSID Broadcast' section of the settings. The teal toggle switch is now turned off. The teal note below it remains: 'Once SSID Broadcast is disabled, you need to manually type in the SSID to join the wireless network.'

2. Tap [Done](#).

■ **Note:**

If the SSID is hidden, it will not be displayed on your wireless device when you scan for local wireless networks. And you need to manually enter the SSID and password to join.

➤ **To hide password on screen:**

1. Disable **Display password on screen**, so the wireless password will not be displayed on the screen of your Mobile Wi-Fi.

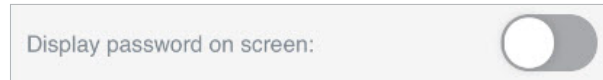

2. Tap **Done**.

5. 2. Block Unwelcome Devices

This feature allows you to restrict unwelcome devices to access the wireless network of your Mobile Wi-Fi.

1. Visit <http://tplinkmifi.net>, and log in with the password you set for the mobile Wi-Fi.
2. Go to **Status > Current Clients**.
3. Tap .

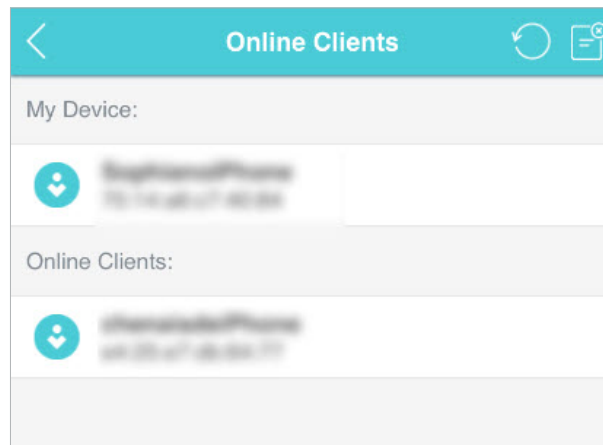

4. Select the device(s) that you want to block from the **Online Clients** list.

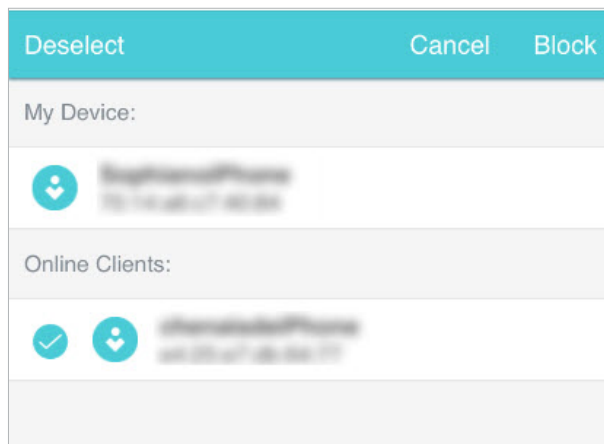

5. Tap **Block**.

5.3. Lock SIM Card

This feature allows you to lock your SIM card with the **PIN** lock. Once the **PIN** lock is enabled, every time you start your Mobile Wi-Fi with your SIM card inserted, you need to enter the PIN code to access the internet.

If you don't wish to enter the PIN code every time you start your Mobile Wi-Fi, you can enable the Auto-unlock PIN upon Power-on function. You will still have to enter the PIN code on other devices with this SIM card, however.

1. Visit <http://tplinkmifi.net>, and log in with the password you set for the Mobile Wi-Fi.
 2. Go to **Device > Advanced > PIN Management**.
- **To enable the PIN lock:**
1. Toggle on **Enable PIN**.
 2. Enter the PIN code of your SIM card, which consists of 4 to 8 digits.

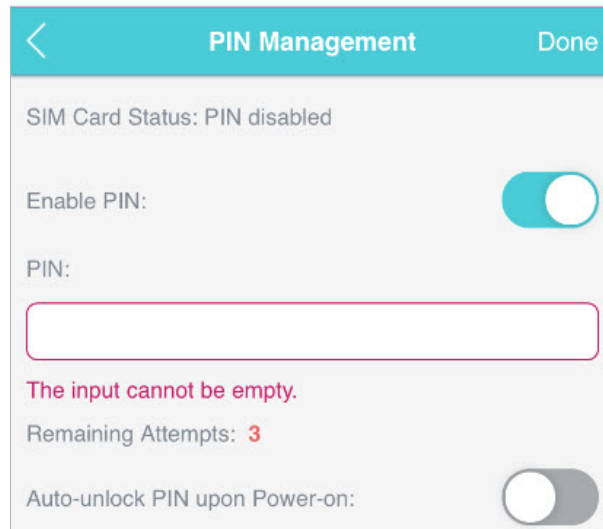

3. Tap **Done**.

4. Visit <http://tplinkmifi.net> to enter the PIN code to access the Internet every time you start your Mobile Wi-Fi.

■ **Note:**

1. The PIN code of your SIM card is preset by your mobile carrier and usually can be found on the package of the SIM card.
2. After 3 failed verification attempts the SIM will be locked, you need to enter the PUK code to unlock it. The PUK code can usually be found on the package of the SIM card.

➤ **To reset PIN code:**

1. Visit <http://tplinkmifi.net> from the PC login entry, and log in with the password you set for the Mobile Wi-Fi.
2. Go to **Advanced > Dial-up > PIN Management**.
3. Select **Enable PIN** from the drop-down list if SIM Card Status is disabled. Enter the PIN code of your SIM card, and then click **Apply**.
4. Select **Modify** from the drop-down list.
5. Enter the current PIN code and a new PIN code twice. The new PIN code must consist of 4-8 digits.

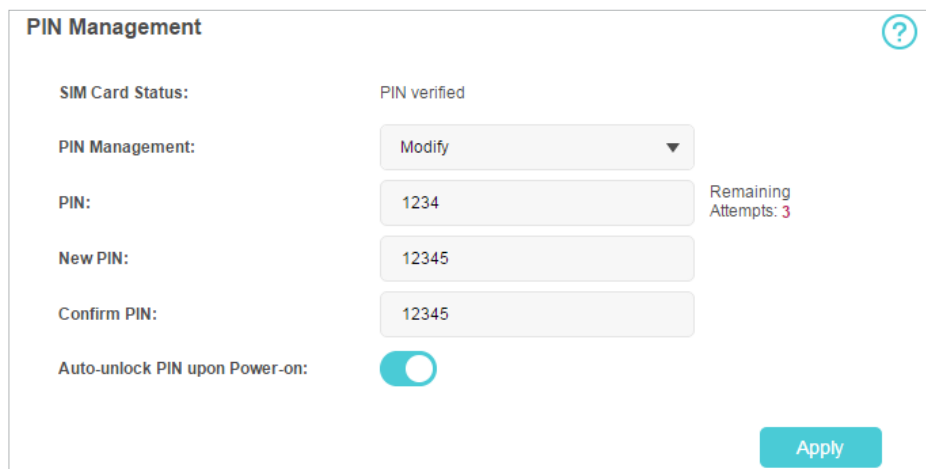

PIN Management

SIM Card Status: PIN verified

PIN Management: Modify

PIN: 1234 Remaining Attempts: 3

New PIN: 12345

Confirm PIN: 12345

Auto-unlock PIN upon Power-on:

Apply

6. Click [Apply](#).

7. Use the new PIN code for future PIN verifications.

➤ **To enable Auto-unlock PIN upon Power-on:**

1. Toggle on [Enable PIN](#), enter the PIN code of your SIM card, and then tap [Done](#).

2. Enable [Auto-unlock PIN upon Power-on](#).

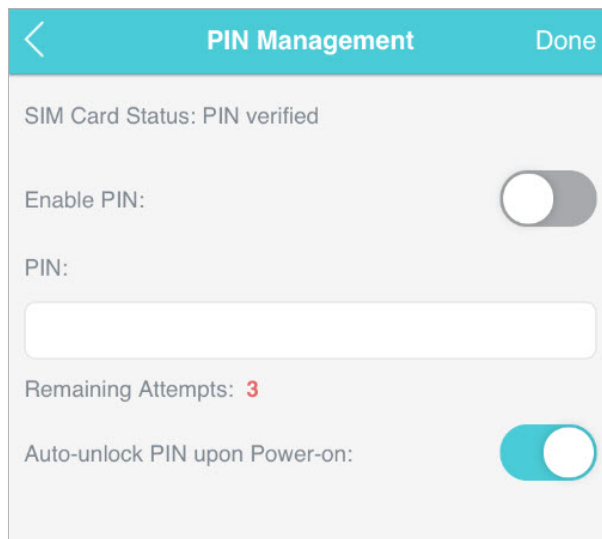

PIN Management Done

SIM Card Status: PIN verified

Enable PIN:

PIN:

Remaining Attempts: 3

Auto-unlock PIN upon Power-on:

3. Once enabled, you can save the trouble of entering the PIN code every time you start your Mobile Wi-Fi.

Chapter 6

Share Files on SD Card

This chapter describes how to share and access files on an SD card via Wi-Fi and via a USB cable.

It contains the following sections:

- [Access via Wi-Fi Mode](#)
- [Access via USB Mode](#)

6.1. Access via Wi-Fi Mode

You can share files on an SD card via Wi-Fi mode so clients connected to the Mobile Wi-Fi can access the SD card.

1. Visit <http://tplinkmifi.net>, and log in with the password you set for the Mobile Wi-Fi.
2. Go to [Device](#) > [Advanced](#) > [Storage Sharing](#).

➤ **To access via an Android or iOS device**

1. Select [By Wi-Fi](#) for Access Mode.

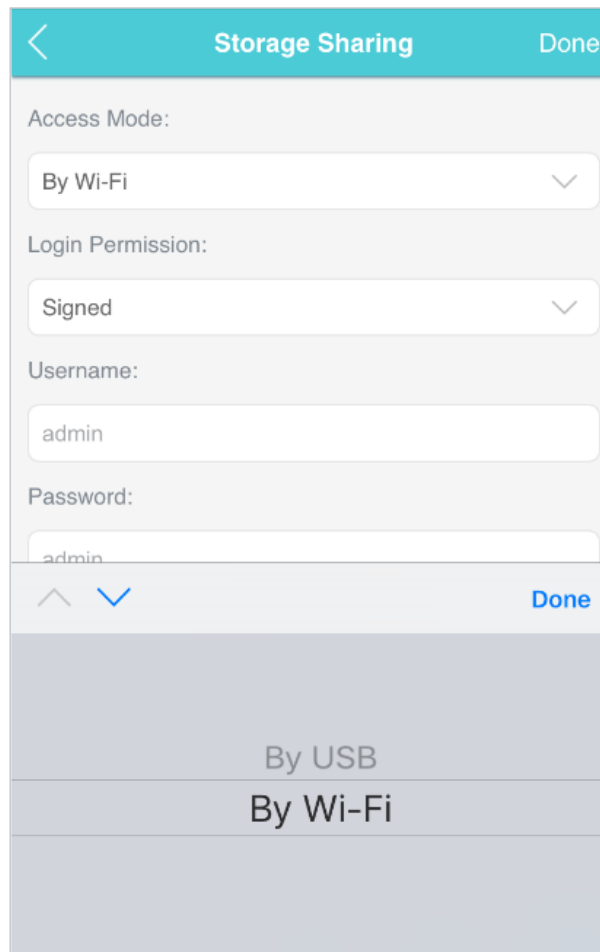

The screenshot displays the 'Storage Sharing' configuration interface. At the top, there is a teal header with a back arrow, the title 'Storage Sharing', and a 'Done' button. Below the header, the 'Access Mode' is set to 'By Wi-Fi'. The 'Login Permission' is set to 'Signed'. The 'Username' field contains 'admin' and the 'Password' field also contains 'admin'. At the bottom of the form, there is a grey bar with an expand/collapse icon and a 'Done' button. A bottom sheet is currently open, showing two options: 'By USB' and 'By Wi-Fi', with 'By Wi-Fi' being the selected option.

2. Select [Signed](#) or [Anonymous](#) for Login Permission.

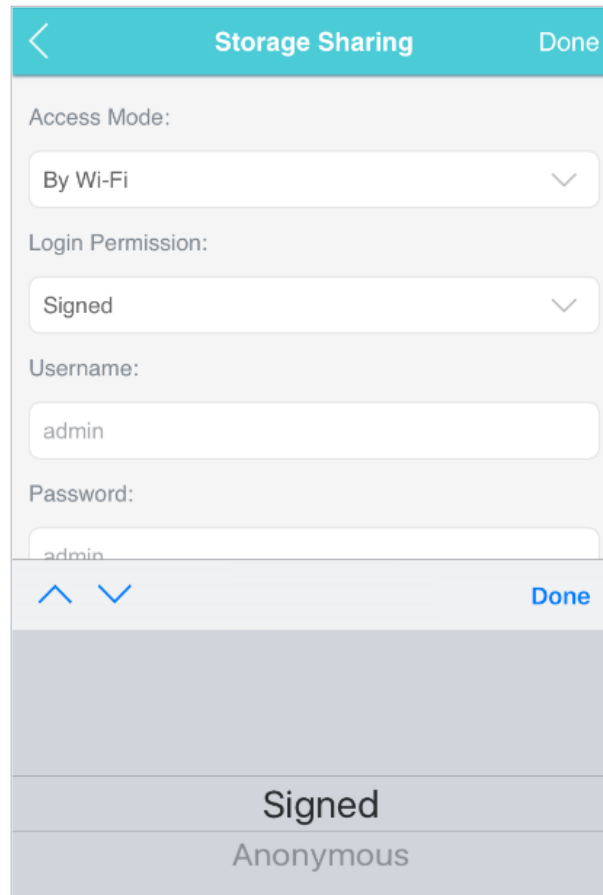

Storage Sharing

Access Mode:

By Wi-Fi

Login Permission:

Signed

Username:

admin

Password:

admin

Done

Signed

Anonymous

Note:

If you have selected **Signed**, please specify Username and Password for access (admin by default).

3. Tap **Done**.

4. Search **tpMiFi** at the App Store Store or Google Play Store or simply scan the QR code to download it.



5. Connect your mobile device to the Mobile Wi-Fi.

6. Launch tpMiFi and enter the password you set for the Mobile Wi-Fi.

7. Tap **SD Sharing** to access the SD card. You can then view, download and upload multimedia files as needed.



- **To access the SD card via a PC:**
1. Select **By Wi-Fi** for Access Mode.

Storage Sharing

Access Mode:
By Wi-Fi

Login Permission:
Signed

Username:
admin

Password:
admin

Done

By USB

By Wi-Fi

2. Select [Signed](#) or [Anonymous](#) for Login Permission.

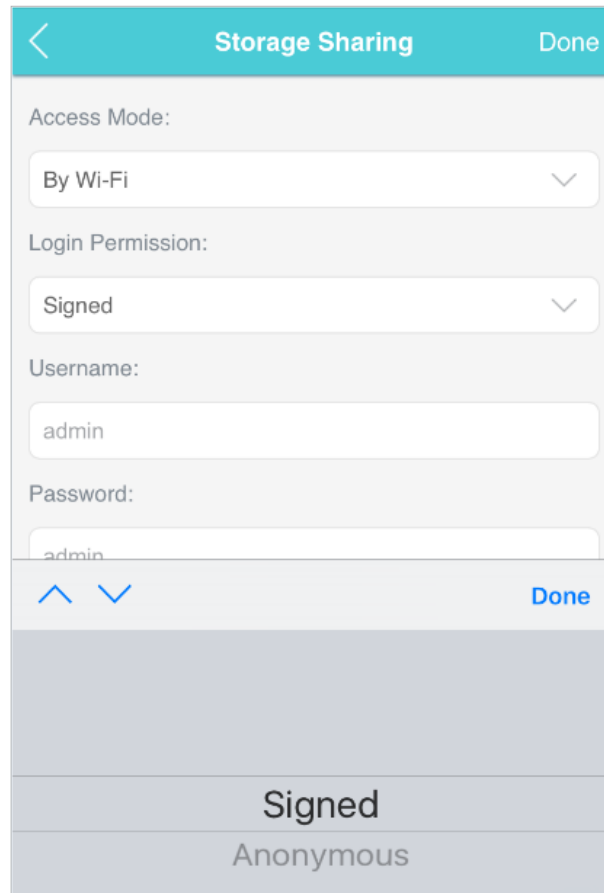

■ **Note:** If you have selected [Signed](#), please specify Username and Password for access (admin by default).

3. Tap [Done](#).

4. Connect your computer to the Mobile Wi-Fi's SSID.

5. Open [Run](#) and input "\\192.168.0.1" (by default) or [ftp://192.168.0.1](#). Then click [OK](#) to continue.

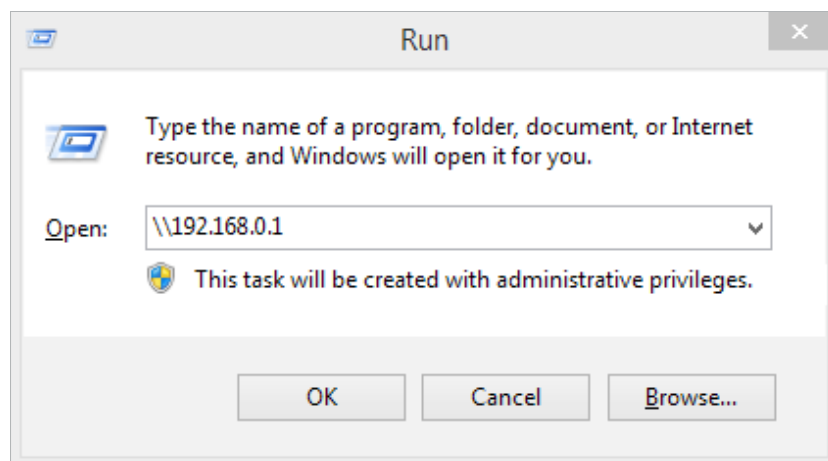

6. For anonymous access, you can now access the SD card. For signed access, enter the login username and password in the authentication window and click **OK**. Then you can access the SD card.



6. 2. Access via USB Mode

You can connect your computer to the Mobile Wi-Fi via a USB cable to access the SD card directly.

1. Select **By USB** for Access Mode.

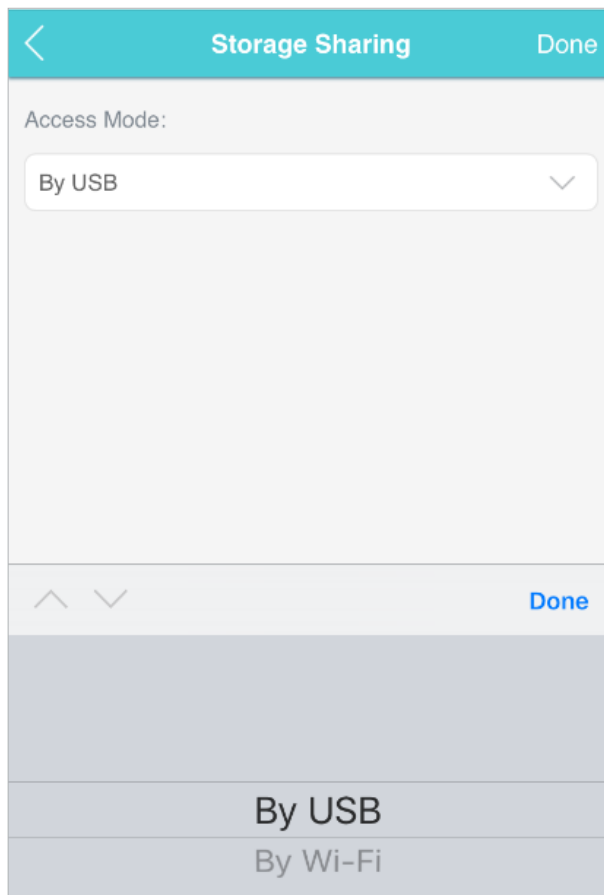

2. Tap **Done**.

3. Connect your computer to the Mobile Wi-Fi via a USB cable and access the SD card directly.

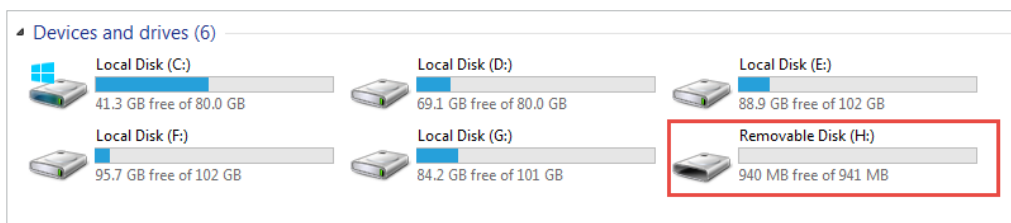

Chapter 7

Customize Your Network

This chapter guides you on how to configure network settings of your Mobile Wi-Fi.

It contains the following sections:

- [Specify Network Mode](#)
- [Specify Network Band](#)
- [Configure Dial-up](#)
- [Configure DHCP Server](#)

7.1. Specify Network Mode

This Mobile Wi-Fi supports three modes of network connection: 4G Preferred, 4G Only and 3G Only. If your SIM card supports WCDMA, select 3G Only; if your SIM card supports FDD-LTE or TDD-LTE, select 4G Preferred or 4G Only as needed. In general, the 4G network is faster than the 3G one.

1. Visit <http://tplinkmifi.net>, and log in with the password you set for the Mobile Wi-Fi.
2. Go to **Device** > **Advanced** > **Network Mode**.
3. Select **4G Preferred**, **4G Only** or **3G Only** as needed.

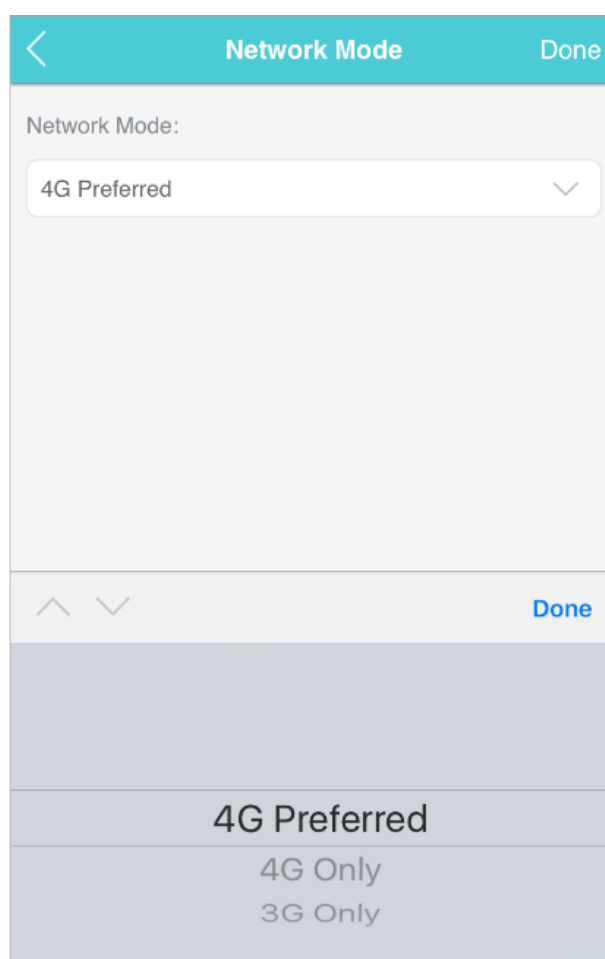

4. Tap **Done**.

7.2. Specify Network Band

This Mobile Wi-Fi supports 2.4GHz and 5GHz wireless bands. In general, the 5GHz band performs better, but covers a smaller area .

1. Visit <http://tplinkmifi.net>, and log in with the password you set for the Mobile Wi-Fi.
2. Go to **Wireless**.
3. Specify **2.4GHz** or **5GHz** for Wireless Band of your Mobile Wi-Fi.

■ Note: If you have specified 5GHz for Wireless Band, devices that only support 2.4GHz cannot connect to the Mobile Wi-Fi.

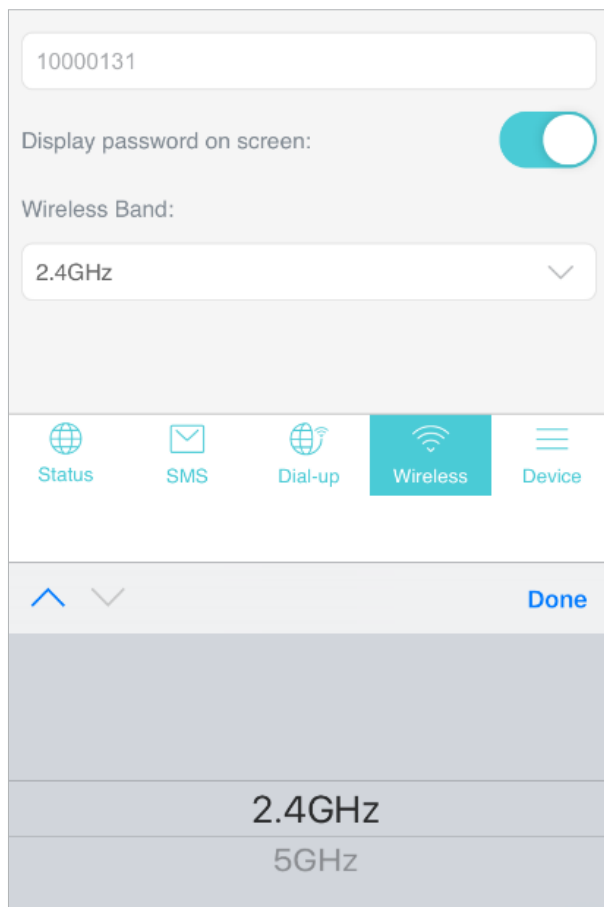

4. Tap **Done**.

7.3. Configure Dial-up

7.3.1. Configure Dial-up Settings

If you are in a location beyond your mobile carrier's service area, you may need to configure the dial-up settings to access the internet provided by a local mobile carrier.

1. Visit <http://tplinkmifi.net>, and log in with the password you set for the Mobile Wi-Fi.

2. Go to [Dial-up](#).
3. Tap [Create](#) to build a dial-up profile.
4. Specify a name for the profile and fill in the parameters provided by your carrier.

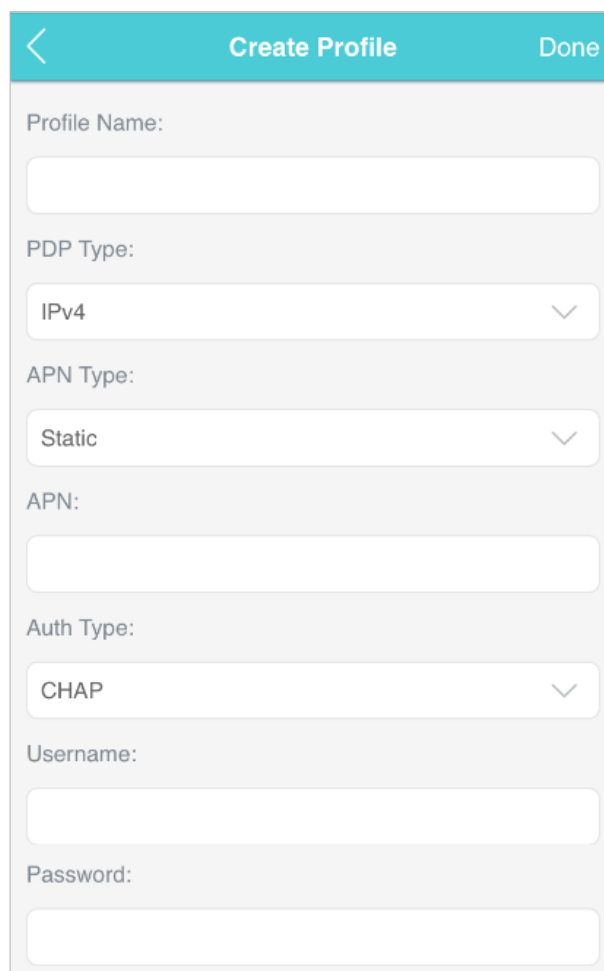

The screenshot shows a 'Create Profile' dialog box with the following fields and options:

- Profile Name:** A text input field.
- PDP Type:** A dropdown menu with 'IPv4' selected.
- APN Type:** A dropdown menu with 'Static' selected.
- APN:** A text input field.
- Auth Type:** A dropdown menu with 'CHAP' selected.
- Username:** A text input field.
- Password:** A text input field.

5. Tap [Done](#) and then tap [Yes](#) in the pop-up to apply the new profile.

■ **Note:**

1. Mobile Data is enabled by default. If disabled, internet access is prohibited.
2. Data Roaming is disabled by default. If enabled, data service is allowed when roaming.
3. You can click [View Profile details](#) to check the current profile. If any parameter is wrong, you can click [Create](#) to build a new one.

7.3.2. Configure Network Search

The Mobile Wi-Fi provides two types of network connection: Auto and Manual.

- **Auto:** The Mobile Wi-Fi will automatically establish Internet connection when it is started.
- **Manual:** When you have selected [Manual](#), click [Search](#) and the Mobile Wi-Fi will scan for mobile networks. You can choose a network with better

performance to connect to. The mobile carrier providing the network must be or have cooperation with your SIM card provider.

1. Visit <http://tplinkmifi.net> from the PC login entry, and log in with the password you set for the Mobile Wi-Fi.
2. Go to [Advanced](#) > [Dial-up](#) > [Network Settings](#).
3. Select [Auto](#) or [Manual](#) for [Network Search](#) as needed.

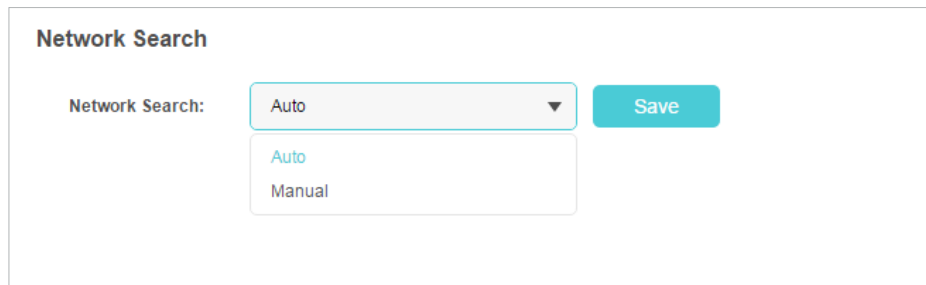

The screenshot shows a web interface for configuring network search settings. The title is "Network Search". On the left, there is a label "Network Search:". To its right is a dropdown menu with "Auto" selected. Below the dropdown is a list of options: "Auto" and "Manual". To the right of the dropdown is a blue "Save" button.

4. Click [Save](#).

7.4. Configure DHCP Server

The Mobile Wi-Fi acts as a DHCP (Dynamic Host Configuration Protocol) server, dynamically assigning TCP/IP parameters to devices from the IP Address pool. You can change the settings of the DHCP server if necessary.

1. Visit <http://tplinkmifi.net> from the PC login entry, and log in with the password you set for the Mobile Wi-Fi.
2. Go to [Advanced](#) > [DHCP Server](#).
3. Enter a new IP address in the [IP Address](#) field and leave the [Subnet Mask](#) as default. And enter the starting and ending IP addresses in the [Start](#) and [End IP Address](#) fields respectively.

■ Note:

1. The Start and End IP Addresses should be on the same network segment as the IP address you have entered.
2. If you have changed the IP address of your Mobile Wi-Fi, you should use the new IP address or <http://tplinkmifi.net> to log into the web management page.

DHCP Server ?

IP Address:	<input type="text" value="192.168.0.1"/>
Subnet Mask:	<input type="text" value="255.255.255.0"/>
Start IP Address:	<input type="text" value="192.168.0.100"/>
End IP Address:	<input type="text" value="192.168.0.199"/>
Lease Time:	<input type="text" value="120"/> minutes (The default value is 120)
Primary DNS Server:	<input type="text" value="192.168.0.1"/>
Secondary DNS Server:	<input type="text" value="0.0.0.0"/> (Optional)

4. Enter the lease time in the [Lease Time](#) field. When the lease time expires, the Mobile Wi-Fi will reassign IP addresses.
5. Enter the primary DNS IP address which usually accords with the IP address.
6. Enter the secondary DNS IP address if provided by your carrier.
7. Click [Save](#).

Chapter 8

Manage Your Mobile Wi-Fi

This chapter presents how to manage and maintain your Mobile Wi-Fi.

It includes the following sections:

- [Save the Mobile Wi-Fi's Power](#)
- [Change Admin Account](#)
- [Set Up System Time](#)
- [Restore Configuration Settings](#)
- [Update the Firmware](#)
- [Update ISP Parameters](#)
- [System Log](#)

8.1. Save the Mobile Wi-Fi's Power

The Power Saving feature allows you to slow down the power consumption of your Mobile Wi-Fi. You can reduce the Wi-Fi range to save power. Alternatively, you can enable the Wi-Fi Auto-disable Time feature to disable the Wi-Fi of your Mobile Wi-Fi in the idling period.

1. Visit <http://tplinkmifi.net>, and log in with the password you set for the Mobile Wi-Fi.

2. Go to **Device > Power Saving**.

➤ **To set Wi-Fi Range:**

1. Enable **Power Saving Mode**.

2. Select **Long**, **Medium** or **Short** from the **Wi-Fi Range** drop-down list.

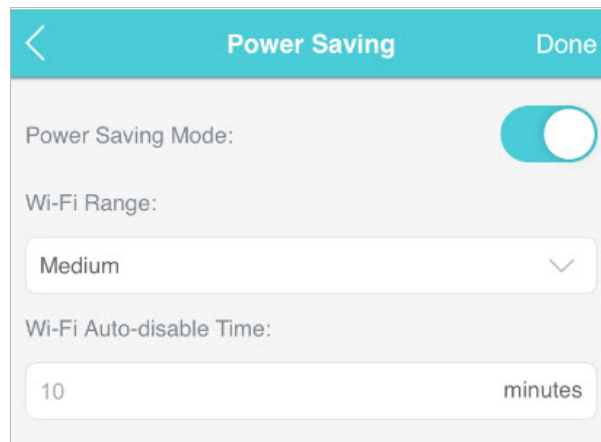

■ **Note:**

The shorter the Wi-Fi Range is, the less power your Mobile Wi-Fi uses.

3. Tap **Done**.

4. Tap **Restart Wi-Fi** on the pop-up to make the configurations take effect, and then reconnect to the Mobile Wi-Fi after the Wi-Fi restarts.

➤ **To set Wi-Fi Auto-disable Time:**

1. Enable **Power Saving Mode**.

2. Specify the **Wi-Fi Auto-disable Time**.

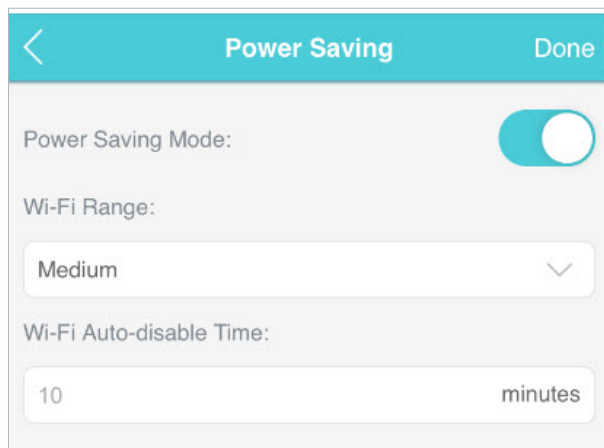

3. Tap **Done**. If there are no devices connected to the Mobile Wi-Fi during the period you have specified, the Wi-Fi will be disabled automatically.

Note:

To recover the Wi-Fi, press the Power Button or the Menu Button.

8.2. Change Admin Account

The account management feature allows you to change your login password of the web management page to prevent other users from logging in to your web management page.

1. Visit <http://tplinkmifi.net>, and log in with the password you set for the Mobile Wi-Fi.
2. Go to **Device > Account**.
3. Enter the current password. Then enter the new password twice (both case-sensitive) and tap **Done**.

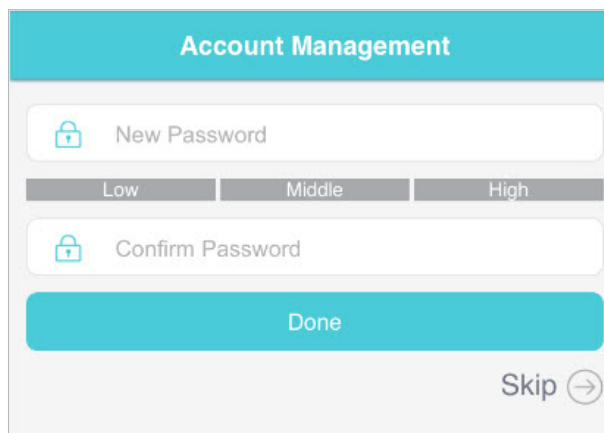

4. Use the new password for future logins.

8.3. Set Up System Time

System time is the time displayed when the Mobile Wi-Fi is running. The system time you configure here will be used for time-based functions.

Note:

Make sure your Mobile Wi-Fi has access to the internet before you set the system time. Otherwise, it can not synchronize the current time and date.

1. Visit <http://tplinkmifi.net>, and log in with the password you set for the mobile Wi-Fi
2. Go to **Device > Advanced > Time Settings**.
3. Select your local **Time Zone** from the drop-down list.

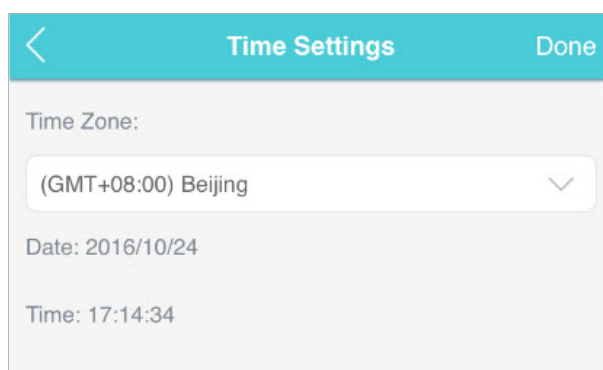

4. Tap **Done**.

8.4. Restore Configuration Settings

The Factory Defaults feature allows you to restore your Mobile Wi-Fi to its factory defaults. After you restore your Mobile Wi-Fi, all previous settings will be cleared and you have to reconfigure them.

➤ **To reset on the Mobile Wi-Fi:**

With the Mobile Wi-Fi powered on, remove the cover. Use a pin to press and hold the **RESET** button until the "Power Off" appears on the screen.

➤ **To reset on the webpage:**

1. Visit <http://tplinkmifi.net> from the PC login entry, and log in with the password you set for the Mobile Wi-Fi .
2. Go to **Advanced > Device > Factory Defaults**.
3. Click **Restore**.

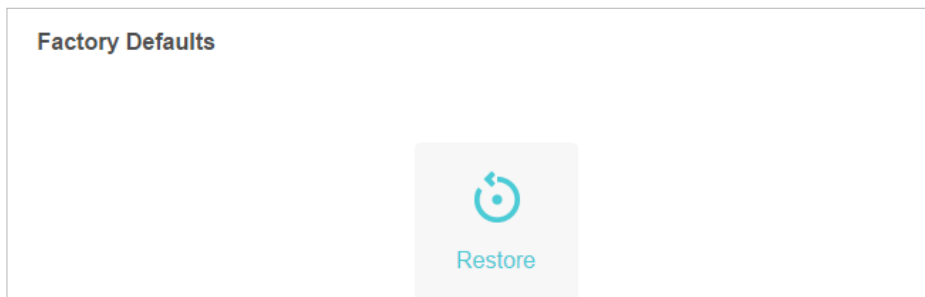

4. Wait a few minutes for the resetting and rebooting.

■ **Note:** During the resetting process, do not power off the Mobile Wi-Fi and make sure it has sufficient power.

8.5. Update the Firmware

TP-Link is dedicated to improving product features to enrich your network experience. We will inform you through the screen and web management page if there's any newly released update firmware for your Mobile Wi-Fi. Also, the latest firmware will be released at TP-Link official website, you can download it from the Support page of our website www.tp-link.com for free.

■ **Note:**

1. Make sure the latest firmware file is matched with the hardware version (as shown in the download section of the Support page).
2. Make sure that you have a stable connection between the Mobile Wi-Fi and your computer.
3. Do NOT power off the Mobile Wi-Fi during the firmware update and make sure it has sufficient power.

➤ **To update the firmware on screen:**

1. Press  (the power button) to update your Mobile Wi-Fi when the following screen appears.

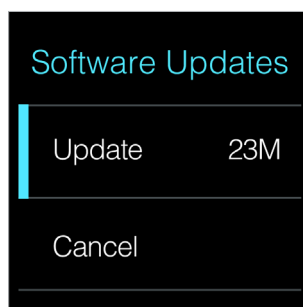

2. Wait a few minutes for the update and reboot.

➤ **To update the firmware locally:**

1. Download the latest firmware file for the Mobile Wi-Fi from our website www.TP-Link.com.
2. Visit <http://tplinkmifi.net> from the PC login entry, and log in with the password you set for the Mobile Wi-Fi.

3. Go to [Advanced](#) > [Device](#) > [Firmware Update](#).
4. Select [Update via the local server](#), click [Browse](#) to locate the downloaded file, and then click [Update](#).

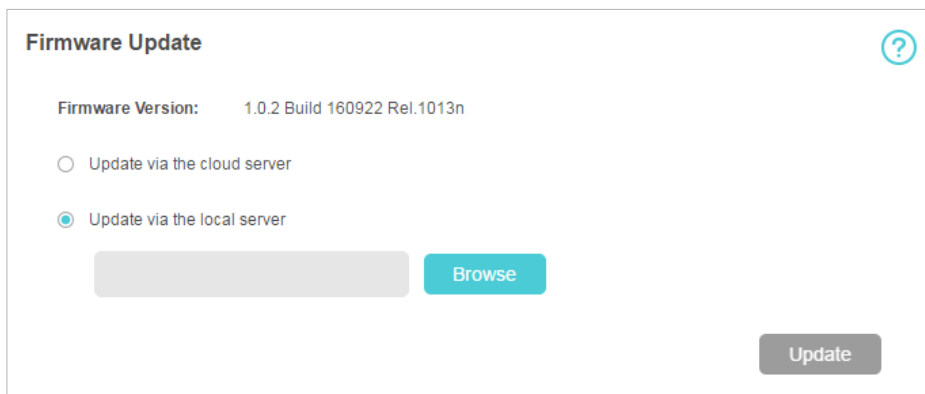

5. Wait a few minutes for the update and reboot.

➤ **To update the firmware online:**

1. Visit <http://tplinkmifi.net> from the PC login entry, and log in with the password you set for the Mobile Wi-Fi.
2. Go to [Advanced](#) > [Device](#) > [Firmware Update](#).
3. Select [Update via the cloud server](#), and click [Update](#).

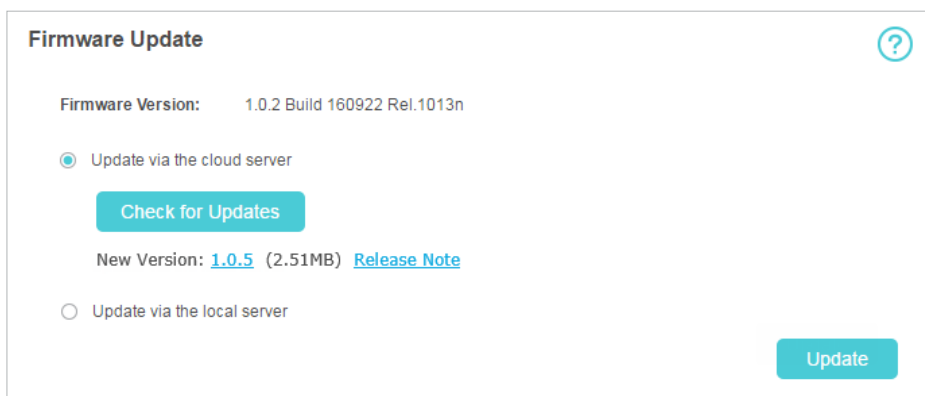

4. Wait a few minutes for the update and reboot.

📌 **Note:**

To download the latest firmware file, you can also click the New Version number, such 1.0.5 in the page above. To view update details, click [Release Note](#).

8. 6. Update ISP Parameters

You can update the ISP information.

1. Download the latest ISP update file from the Support page at www.tp-link.com.

2. Visit <http://tplinkmifi.net> from the PC login entry, and log in with the password you set for the Mobile Wi-Fi.
3. Go to [Advanced](#) > [Dial-up](#) > [ISP Update](#).
4. Click [Browse](#) to locate the downloaded file.
5. Click [Update](#).

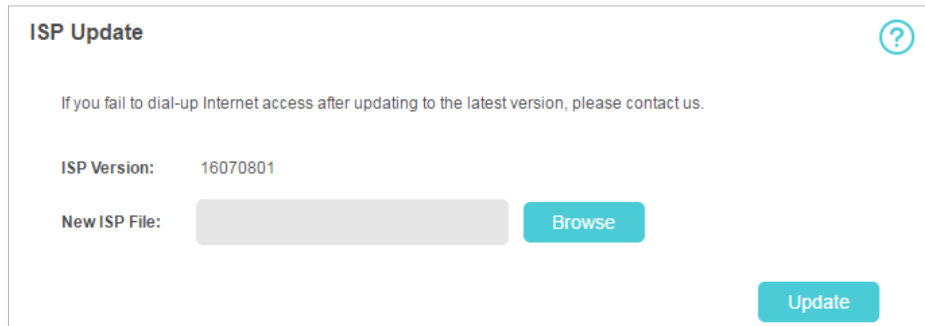

The screenshot shows the 'ISP Update' page. At the top left is the title 'ISP Update' and a help icon (question mark in a circle) at the top right. Below the title is a message: 'If you fail to dial-up Internet access after updating to the latest version, please contact us.' Underneath, it displays 'ISP Version: 16070801'. There is a 'New ISP File:' label followed by a greyed-out text input field and a teal 'Browse' button. At the bottom right, there is a teal 'Update' button.

8.7. System Log

When the Mobile Wi-Fi does not work normally, you can save the system log and send it to our technical support for troubleshooting.

1. Visit <http://tplinkmifi.net> from the PC login entry, and log in with the password you set for the Mobile Wi-Fi.
 2. Go to [Advanced](#) > [Device](#) > [System Log](#).
- **To save the system logs in local:**
Click [Save Logs](#) to save the logs to your local device.

System Log ?

Log Type: ALL ▼ Log Level: ALL ▼ Refresh Clear

ID	Time	Type	Level	Content
1	10-25 06:34:53	DHCP	INFO	DHCPACK(bridge0) 192.168.0.179 fe:88:1c:6b:db:43 win7-PC
2	10-25 06:34:53	DHCP	INFO	DHCPINFORM(bridge0) 192.168.0.179 fe:88:1c:6b:db:43
3	10-25 06:32:47	4G	INFO	Registered with a network!
4	10-25 06:32:47	4G	INFO	Not registered, searching!
5	10-25 06:32:45	SYSTEM	NOTICE	User clear all logs.

Debug Log:

Save Logs

➤ To debug logs:

The Debug Log feature can save logs for specific troubleshooting. This function should be enabled under the requirement of our technical support.

1. Insert an SD card of at least 100MB storage in your Mobile Wi-Fi.
2. Put the file provided by our technical support in the SD card.
3. Go to the [Advanced](#) > [Storage Sharing](#) and set [By Wi-Fi](#) as Access Mode.
4. Enable [Debug Log](#).
5. Click [Save Logs](#).
6. Visit the SD card and send the saved files to our technical support.

Debug Log:

Save Logs

📌 Note:

Do not remove the SD card or switch the storage sharing mode when using this function.

FAQ

Q1. What can I do if I cannot log into the web management page?

- Verify that your device is connected to the Mobile Wi-Fi.
- Verify that you have entered <http://tplinkmifi.net> or <http://192.168.0.1> correctly.
- Verify that your device is set to obtain an IP address automatically.

Q2. What can I do when one of the following messages appears on the screen or I cannot access the Internet?

➤ PIN Required

- Log in to the web management page <http://tplinkmifi.net>. Enter the PIN provided by your carrier and tap **Done**.

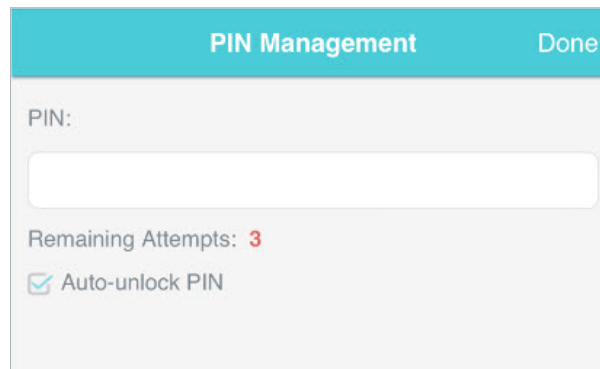

The screenshot shows a mobile application interface for PIN management. At the top, there is a teal header bar with the text 'PIN Management' on the left and a 'Done' button on the right. Below the header, the screen is light gray. It features a 'PIN:' label followed by a white text input field. Underneath the input field, it says 'Remaining Attempts: 3' in red text. At the bottom of the screen, there is a checked checkbox with the label 'Auto-unlock PIN'.

➤ No SIM Card

- Power off the Mobile Wi-Fi and reinsert the SIM card.

➤ No Service

- Verify that your SIM card is an LTE , WCDMA or GSM SIM card.
- Verify that your SIM card is in your mobile carrier' s service area and has sufficient credit.
- Verify that your mobile carrier parameters are correct: Log into the web management page, go to **Dial-up** and tap **View profile details** to check if APN, Username and Password are correct. If not, return to the **Dial-up** page and create a new profile with the correct information. Then tap **Done** and confirm on the pop-up.

➤ icon

- Log in to the web management page, and go to **Dial-up** to enable **Data Roaming**.

Q3. What can I do if my internet speed is slow?

Log in to the web management page and try the methods below:

- If you are experiencing intermittent slow Internet connection, go to [Wi-Fi Band](#) to switch between 2.4GHz and 5GHz for better connectivity.
- The 4G network may be temporarily unavailable in your current location. Go to [Network Mode](#) and try a different network.

Q4. How to reset the Mobile Wi-Fi to its factory default settings?

- With the Mobile Wi-Fi powered on, remove the cover. Use a pin to press and hold the [RESET](#) button (hole) until [Power Off](#) appears on the screen and then release the button.
- Log into the Mobile Wi-Fi's web management page via the PC login entry. Go to [Advanced](#) > [Device](#) > [Factory Defaults](#) and click [Restore](#).

COPYRIGHT & TRADEMARKS

Specifications are subject to change without notice.  is a registered trademark of TP-Link Technologies Co., Ltd. Other brands and product names are trademarks or registered trademarks of their respective holders.

No part of the specifications may be reproduced in any form or by any means or used to make any derivative such as translation, transformation, or adaptation without permission from TP-Link Technologies Co., Ltd.

Copyright © 2017 TP-Link Technologies Co., Ltd. All rights reserved.

CE Mark Warning



This is a class B product. In a domestic environment, this product may cause radio interference, in which case the user may be required to take adequate measures.

OPERATING FREQUENCY(the maximum transmitted power)

2412MHz—2472MHz (20dBm)

5180MHz—5240MHz (23dBm)

EU declaration of conformity

TP-Link hereby declares that the device is in compliance with the essential requirements and other relevant provisions of directives 2014/53/EU and 2011/65/EU.

The original EU declaration of conformity may be found at <http://www.tp-link.com/en/ce>

RF Exposure Information

This device meets the EU requirements (2014/53/EU Article 3.1a) on the limitation of exposure of the general public to electromagnetic fields by way of health protection.

This device has been tested and meets the ICNIRP exposure guidelines and the European Standard EN 62209-2. SAR is measured with this device at a separation of 0.5 cm to the body, while transmitting at the highest certified output power level in all frequency bands of this device. Carry this device at least 0.5 cm away from your body to ensure exposure levels remain at or below the as-tested levels.

Restricted to indoor use.

NCC Notice

注意！

依據 低功率電波輻射性電機管理辦法

第十二條 經型式認證合格之低功率射頻電機，非經許可，公司、商號或使用者均不得擅自變更頻率、加大功率或變更原設計之特性或功能。

第十四條 低功率射頻電機之使用不得影響飛航安全及干擾合法通信；經發現有干擾現象時，應立即停用，並改善至無干擾時方得繼續使用。前項合法通信，指依電信規定作業之無線電信。低功率射頻電機需忍受合法通信或工業、科學以及醫療用電波輻射性電機設備之干擾。

減少電磁波影響，請妥適使用。

BSMI Notice

安全諮詢及注意事項

- 請使用原裝電源供應器或只能按照本產品注明的電源類型使用本產品。
- 清潔本產品之前請先拔掉電源線。請勿使用液體、噴霧清潔劑或濕布進行清潔。
- 注意防潮，請勿將水或其他液體潑灑到本產品上。
- 插槽與開口供通風使用，以確保本產品的操作可靠並防止過熱，請勿堵塞或覆蓋開口。
- 請勿將本產品置放於靠近熱源的地方。除非有正常的通風，否則不可放在密閉位置中。
- 請不要私自打開機殼，不要嘗試自行維修本產品，請由授權的專業人士進行此項工作。

限用物質含有情況標示聲明書

產品元件名稱	限用物質及其化學符號					
	鉛 Pb	鎘 Cd	汞 Hg	六價鉻 CrVI	多溴聯苯 PBB	多溴二苯醚 PBDE
PCB	○	○	○	○	○	○
外殼	○	○	○	○	○	○
鋰電池	○	○	○	○	○	○

備考 1. "超出 0.1 wt %" 及 "超出 0.01 wt %" 系指限用物質之百分比含量超出百分比含量基準值。
備考 2. "○" 系指該項限用物質之百分比含量未超出百分比含量基準值。
備考 3. "—" 系指該項限用物質為排除項目。



Продукт сертифіковано згідно с правилами системи УкрСЕПРО на відповідність вимогам нормативних документів та вимогам, що передбачені чинними законодавчими актами України.





Safety Information

- Keep the device away from water, fire, humidity or hot environments.
- Do not attempt to disassemble, repair, or modify the device.
- Do not use damaged charger or USB cable to charge the device.
- Do not use any other chargers than those recommended
- Do not use the device where wireless devices are not allowed.

- Do not disassemble, crush, puncture, short external contacts, or dispose of the battery in fire or water.
- CAUTION: RISK OF EXPLOSION IF BATTERY IS REPLACED BY AN INCORRECT TYPE. DISPOSE OF USED BATTERIES ACCORDING TO THE INSTRUCTIONS.

Please read and follow the above safety information when operating the device. We cannot guarantee that no accidents or damage will occur due to improper use of the device. Please use this product with care and operate at your own risk.

Explanations of the symbols on the product label

Symbol	Explanation
	DC voltage
	<p>RECYCLING</p> <p>This product bears the selective sorting symbol for Waste electrical and electronic equipment (WEEE). This means that this product must be handled pursuant to European directive 2012/19/EU in order to be recycled or dismantled to minimize its impact on the environment.</p> <p>User has the choice to give his product to a competent recycling organization or to the retailer when he buys a new electrical or electronic equipment.</p>