

Installation Guide

WT44xxxxLL

Menu board mount, multiple screens up to 55"

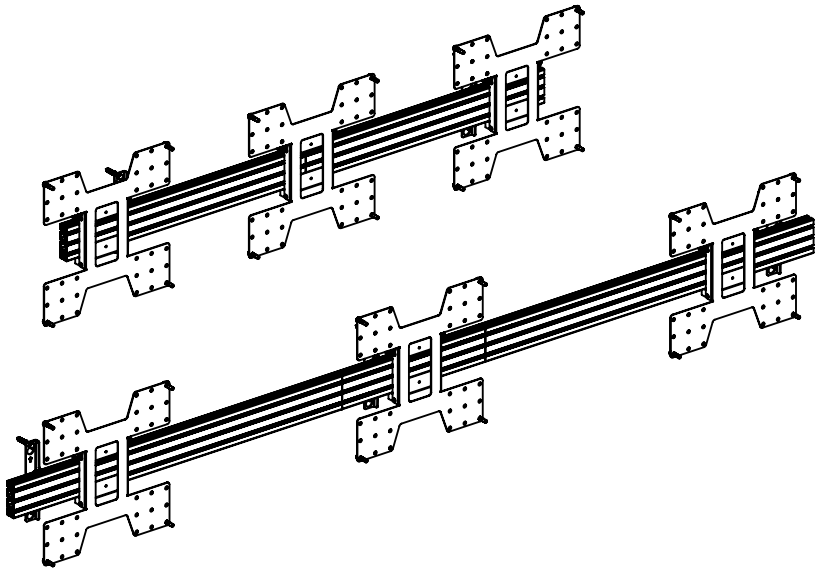



CAUTION

- This product must be installed by a professional installer.
- This product is designed to be wall mounted. Before installing, please verify that the wall can bear the combined weight of the solution and hardware. Standard fixings for wooden material and fixings for concrete material are supplied as part of the product, but they will not be suitable for all types of walls. It is the responsibility of the installer to use the appropriate fixings for the specific installation location
- The maximum weight limit for this product is 150 kg per wall bracket. Do not exceed the stated weight limit.
- This product is intended for indoor use only.
- Please don't power the hardware, until the entire solution is fully assembled.
- If these installation instructions are not followed precisely, it could lead to product failure and potential personal injury.
- Ergonomic Solutions / SpacePole inc. cannot be held responsible for any product failure or personal injury, if the installation instructions are not followed correctly.
- Ergonomic Solutions / SpacePole inc. cannot be held responsible for any product failure or personal injury, if any modifications have been made to the product by the customer.

MAINTENANCE

- It is the responsibility of the customer to periodically check the installation and ensure it is clean, all air ventilation holes are free and all fixings are tightened correctly.

Tool list

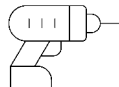
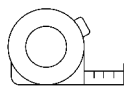
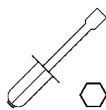
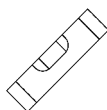

Optional





Box content

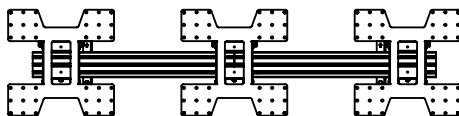

WT443160LL



  12x Spacer $\varnothing 8.4/\varnothing 15.5 \times 5$

  16x $\varnothing 8/\varnothing 16$ washer

 4x $\varnothing 10 \times 50$ wall plug

  4x M6 T-nut

 4x M6x10 screw (for T-nut)

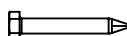
 4x Wood screw 8X60

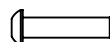
 12x M8x35 screw

 12x M8x25 screw

 12x M8x16 screw

 12x M6x12 screw



2x (A)

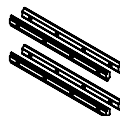

1x (B)
set of 4

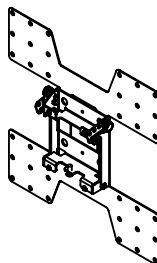

3x (C)



2x (D)
L = 800mm

Tool list

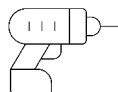
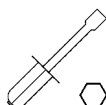
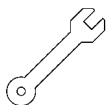
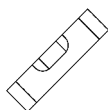

Optional





Box content

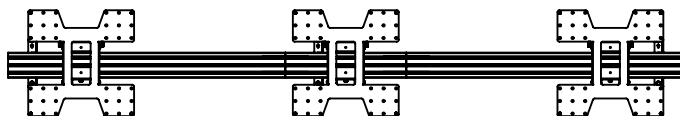

WT443268LL



  12x Spacer $\varnothing 8.4/\varnothing 15.5 \times 5$

  16x $\varnothing 8/\varnothing 16$ washer

 4x $\varnothing 10 \times 50$ wall plug

  4x M6 T-nut

 4x M6x10 screw (for T-nut)

 4x Wood screw 8X60

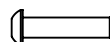
 12x M8x35 screw

 12x M8x25 screw

 12x M8x16 screw

 12x M6x12 screw



3x (A)

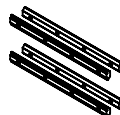

2x (B)
set of 4

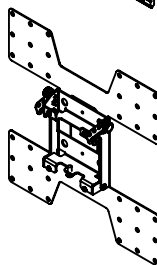

3x (C)



2x (E)
L = 1100mm

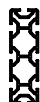

1x (F)
L = 480mm

Dimensions [mm]

WT44xxxxLL

Recommended position for wall brackets

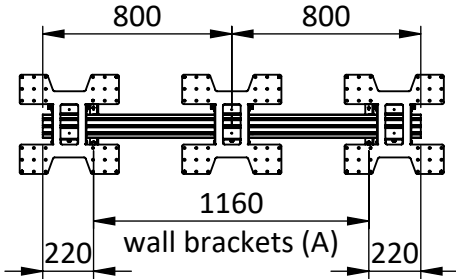

WT443160LL

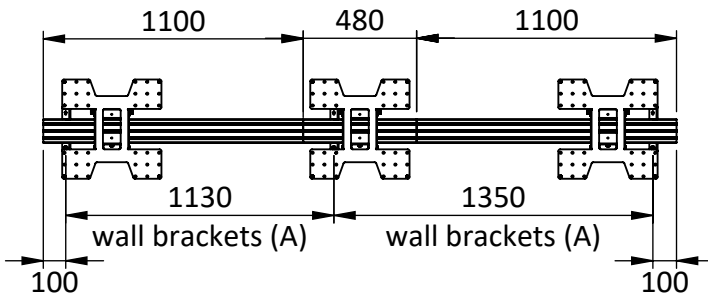

WT443268LL

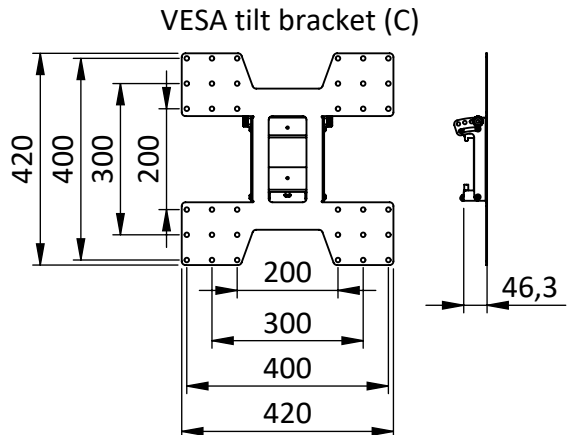
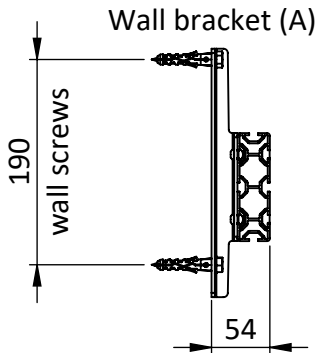

Optional: Shorten rails

Shorten rails to fit smaller screens

The rails can be shorten if:

- The screens are smaller than the maximum specified screen size.
- Fewer screens than the maximum specified number of screens are used.
- The orientation of the screens are different from the specified orientation.

It is the responsibility of the installer to measure the exact dimensions of the screens, before cutting the rails.

Cutting guidelines:

Screen size	Orientation	Number of screens	Minimum rail length	Maximum rail length
32"	Portrait	2	620	839
32"	Portrait	3	1090	1259
42/43"	Portrait	2	720	1082
42/43"	Portrait	3	1300	1623
49" / 50"	Portrait	2	810	1216
49" / 50"	Portrait	3	1470	1824
55"	Portrait	2	880	1362
32"	Landscape	2	900	1450
32"	Landscape	3	1650	2175
42/43"	Landscape	2	1120	1894

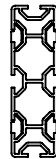
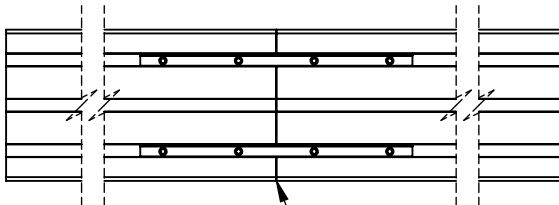

Do not cut on assembled ends

Steps

Step 1: Rail assembly

1. Slide in connector bars in one rail.
2. Assemble with second rail.
3. Tighten screws.

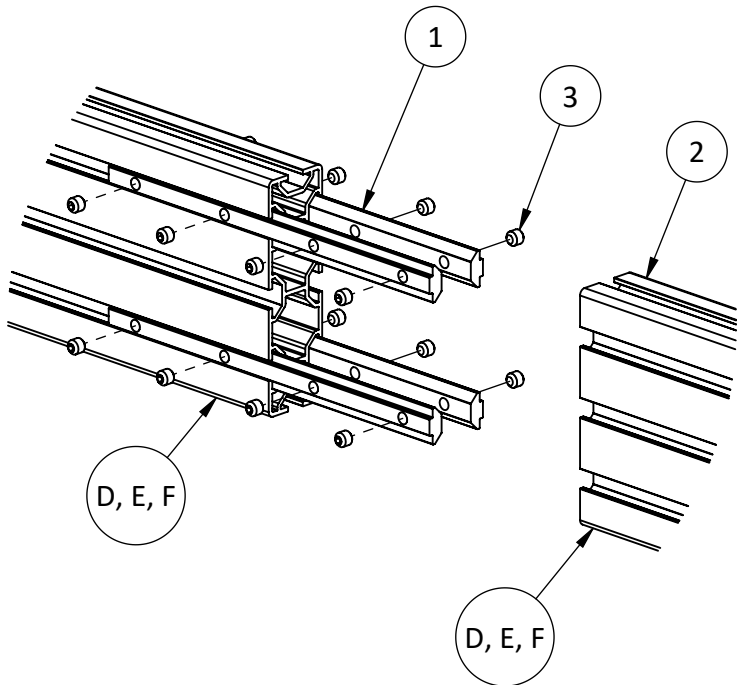

Steps

Step 2: Mount wall brackets (A) on rails (D, E, F)

1. Flip in two T-Bar nut.
2. Attach wall bracket (A) with M6x10 screws
 - Repeat with all wall brackets (A)

See dimension guide for position of wall brackets (A)

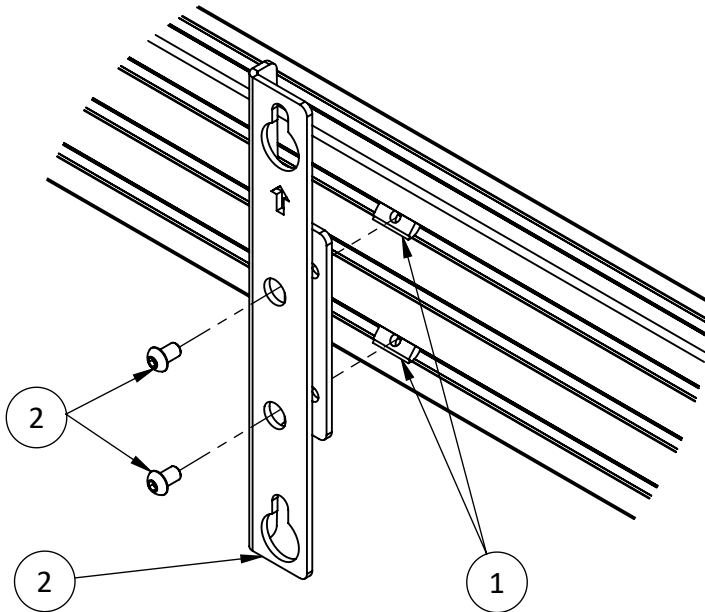

Steps

Step 3: Mount rail with wall brackets on wall

1. Mark position for first screw in wall bracket (A).
2. Drill hole/insert wall plug.
3. Mount a screw approx. 7mm from the wall.
4. Hang the assembled rail on the screw, use the keyhole.
5. Mark for the rest of the wall plug.
 - Drill holes/insert wall plugs.
 - Mount the rail and tighten all wall screws.

Make sure to align rail horizontally when marking

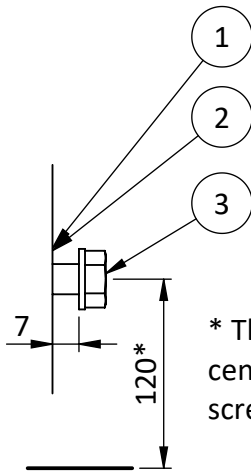

WARNING: It is the responsibility of the installer to use the correct fixings for the specific installation site.

* The distance from upper wall screw to center of VESA/mounting pattern at the screen.

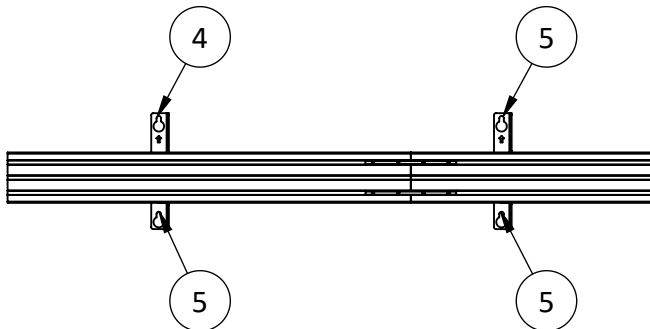

Steps

Step 4: Mount VESA bracket (A) on screens

Parts supplied (per screen)

1x (C)

4x M6x12 screws

4x M8x16 screws

4x M8x25 screws

4x M8x35 screws

4x $\varnothing 8/\varnothing 16$ washer

4x $\varnothing 8.4/\varnothing 15$ black spacer

WARNING: Select appropriate screw length/size, combine with washer/spacer if needed.

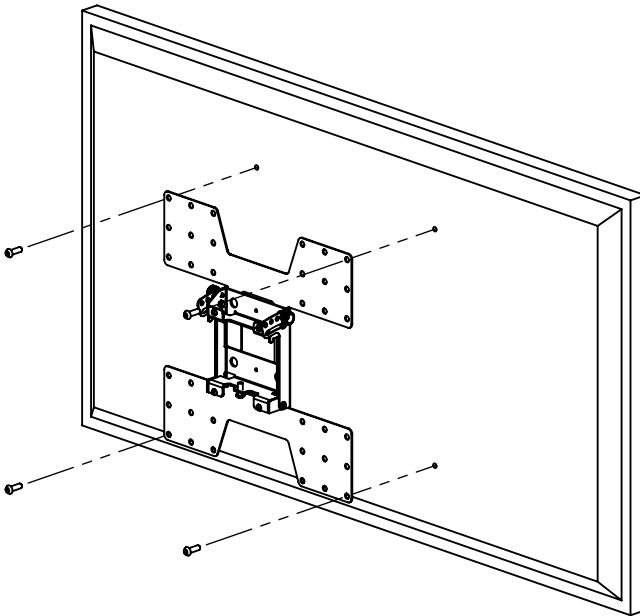

Steps

Step 5: Tilt the screen.

Tilt options:

0 degrees

5 degrees

10 degrees

15 degrees

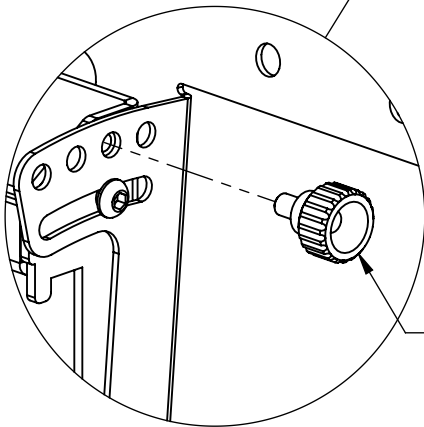
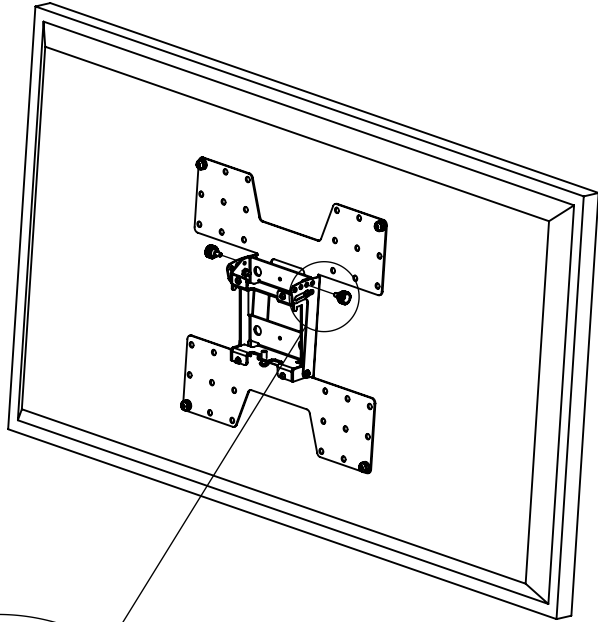

Remove 2 x thumb screws and tilt to required angle, insert and tighten the thumb screws again.

Steps

Step 6: Hook all screens on to the rail and level screens.

- 1 Attach to the top of the wall mount.
- 2 Lower the screen.
- 3 Swing in the bottom of the screen.
- 4 Level the screen with levelling screws.
- 5 Secure VESA bracket (B) with screw underneath.

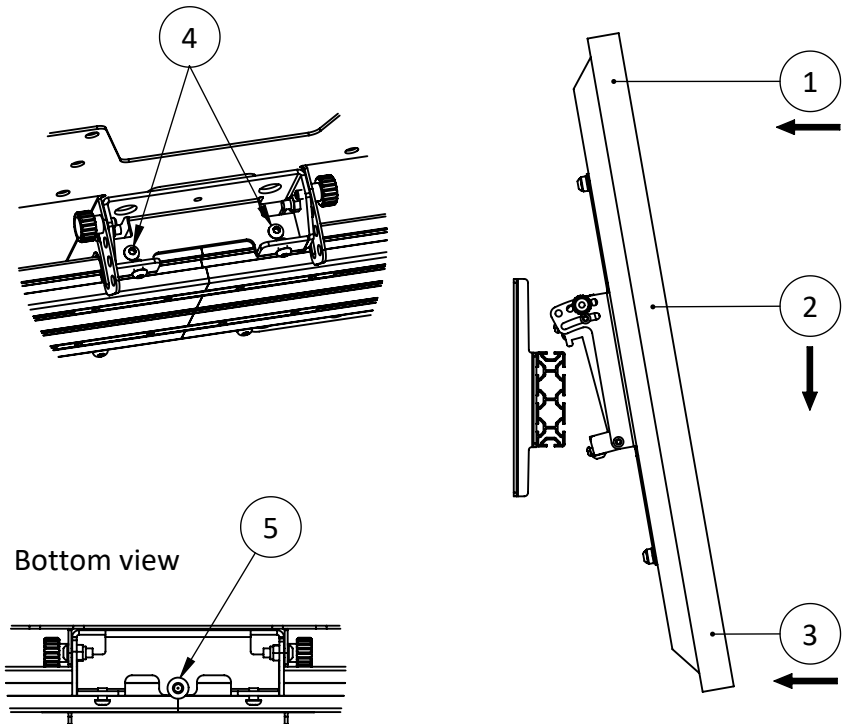

This page intentionally left blank

This page intentionally left blank

This page intentionally left blank

Need help? Contact us



ergonomic.solutions/about/contact-us

spacepole.com/about/contact-us