

VB342 Pro

Conference Camera

User Manual



FEDERAL COMMUNICATIONS COMMISSION

NOTE: This equipment has been tested and found to comply with the limits for a Class A digital device, pursuant to part 15 of the FCC Rules. These limits are designed to provide reasonable protection against harmful interference when the equipment is operated in a commercial environment. This equipment generates, uses, and can radiate radiofrequency energy and, if not installed and used in accordance with the instruction manual, may cause harmful interference to radio communications. Operation of this equipment in a residential area is likely to cause harmful interference in which case the user will be required to correct the interference at his own expense.

FCC Caution: Any changes or modifications not expressly approved by the party responsible for compliance could void the user's authority to operate this equipment.

This device complies with part 15 of the FCC Rules.

Operation is subject to the following two conditions:

- (1) This device may not cause harmful interference, and
- (2) this device must accept any interference received, including interference that may cause undesired operation.

Warning:

This is a class A product. In a domestic environment this product may cause radio interference in which case the user may be required to take adequate measures.

This Class A digital apparatus complies with Canadian ICES-003. Cet appareil numérique de la classe A est conforme à la norme NMB-003 du Canada.

この装置は、クラス A 機器です。この装置を住宅環境で使用すると電波妨害を引き起こすことがあります。この場合には使用者が適切な対策を講ずるよう要求されることがあります。 VCCI-A

사 용 자 안 내 문	
이 기기는 업무용 환경에서 사용할 목적으로 적합성평가를 받은 기기로서 가정용 환경에서 사용하는 경우 전자파간섭의 우려가 있습니다.	
※ 사용자 안내문은 "업무용 방송통신기자재"에만 적용됩니다.	

기종별	사용자안내문
A 급 기기 (업무용 방송통신기자재)	이 기기는 업무용(A 급) 전자파적합기기로서 판매자 또는 사용자는 이 점을 주의하시기 바라며, 가정외의 지역에서 사용하는 것을 목적으로 합니다.

DISCLAIMER

No warranty or representation, either expressed or implied, is made with respect to the contents of this documentation, its quality, performance, merchantability, or fitness for a particular purpose. Information presented in this documentation has been carefully checked for reliability; however, no responsibility is assumed for inaccuracies. The information contained in this documentation is subject to change without notice.

In no event will AVer Information Inc. be liable for direct, indirect, special, incidental, or consequential damages arising out of the use or inability to use this product or documentation, even if advised of the possibility of such damages.

TRADEMARKS

“AVer” is a trademark owned by AVer Information Inc. Other trademarks used herein for description purpose only belong to each of their companies.

COPYRIGHT

©2022 AVer Information Inc. All rights reserved.

All rights of this object belong to AVer Information Inc. Reproduced or transmitted in any form or by any means without the prior written permission of AVer Information Inc. is prohibited. All information or specifications are subject to change without prior notice.

NOTICE

SPECIFICATIONS ARE SUBJECT TO CHANGE WITHOUT PRIOR NOTICE. THE INFORMATION CONTAINED HEREIN IS TO BE CONSIDERED FOR REFERENCE ONLY.



THE MARK OF CROSSED-OUT WHEELED BIN INDICATES THAT THIS PRODUCT MUST NOT BE DISPOSED OF WITH YOUR OTHER HOUSEHOLD WASTE. INSTEAD, YOU NEED TO DISPOSE OF THE WASTE EQUIPMENT BY HANDING IT OVER TO A DESIGNATED COLLECTION POINT FOR THE RECYCLING OF WASTE ELECTRICAL AND ELECTRONIC EQUIPMENT. FOR MORE INFORMATION ABOUT WHERE TO DROP OFF YOUR WASTE EQUIPMENT FOR RECYCLING, PLEASE CONTACT YOUR HOUSEHOLD WASTE DISPOSAL SERVICE OR THE SHOP WHERE YOU PURCHASED THE PRODUCT.

WARNING

- To reduce risk of fire or electric shock, do not expose this appliance to rain or moisture. Warranty will be void if any unauthorized modifications are done to the product.
- Do not drop the camera or subject it to physical shock.
- Use correct power supply voltage to avoid damaging camera.
- Do not place the camera where the cord can be stepped on as this may result in fraying or damage to the lead or the plug.
- Hold the bottom of the camera with both hands to move the camera. Do not grab the lens or lens holder to move the camera.

Remote Control Battery Safety Information

- Store batteries in a cool and dry place.
- Do not throw away used batteries in the trash. Properly dispose used batteries through specially approved disposal methods.
- Remove the batteries if they are not in use for long periods of time. Battery leakage and corrosion can damage the remote control. Dispose of batteries safely and through approved disposal methods.
- Do not use old batteries with new batteries.
- Do not mix and use different types of batteries: alkaline, standard (carbon-zinc) or rechargeable (nickel-cadmium).
- Do not dispose of batteries in a fire.
- Do not attempt to short circuit the battery terminals.

CAUTION

- Risk of explosion if battery is replaced by an incorrect type.
- Dispose of used batteries in a safe and proper manner.

遥控器电池安全信息

- 请将电池存放在凉爽与干燥的位置。
- 不要将电量用尽的电池弃置在家庭废弃物中。请将电池弃置在特定回收处,或送回原购买的商店。
- 如果长时间不使用电池,请将其取出。电池漏液与腐蚀可能会损坏遥控器,请以安全方式弃置电池。
- 不可混用新旧电池。
- 不可混用不同类型的电池:碱性、标准(碳锌)或可充电(镍镉)电池。
- 不可将电池弃置于火源中。
- 请勿尝试让电池端子短路。

More Help

For FAQs, technical support, software and user manual download, please visit:

Headquarters

Download Center: <https://www.aver.com/download-center>

Technical Support: <https://www.aver.com/technical-support>

USA Branch office

Download Center: <https://www.averusa.com/business/support/>

Technical Support: <https://averusa.force.com/support/s/contactsupport>

Europe Branch office

Download Center: <https://www.avereurope.com/download-center>

Technical Support: <https://www.avereurope.com/technical-support>

Contact Information

Headquarters

AVer Information Inc.

<https://www.aver.com>

8F, No.157, Da-An Rd., Tucheng Dist., New Taipei City 23673, Taiwan

Tel: +886 (2) 2269 8535

USA Branch office

AVer Information Inc., Americas

<https://www.averusa.com>

668 Mission Ct., Fremont, CA 94539, USA

Tel: +1 (408) 263 3828

Toll-free: +1 (877) 528 7824

Technical support: support.usa@aver.com

Europe Branch office

AVer Information Europe B.V.

<https://www.avereurope.com>

Westblaak 134, 3012 KM, Rotterdam, The Netherlands

Tel: +31 (0) 10 7600 550

Technical support: eu.rma@aver.com

Japan Branch Office

アバー・インフォメーション株式会社

<https://jp.aver.com>

〒160-0023 日本東京都新宿区西新宿 3-2-26 立花新宿ビル 7 階

Tel: +81 (0) 3 5989 0290

テクニカル・サポート: VCInfo.JP@aver.com

Vietnam Branch Office

Công ty TNHH AVer Information (Việt Nam)

Tầng 5, 596 Nguyễn Đình Chiểu, P.3, Quận 3, Thành phố Hồ Chí Minh 700000, Việt Nam

Tel: +84 (0)28 22 539 211





Contents

Package Contents.....	1
Optional Accessories.....	2
Product Introduction.....	3
Overview	3
LED Indicator.....	4
Wall Mount Installation	5
TV VESA Mount Installation (Optional)	6
Remote Control	9
Installation	12
Device Connection	12
BT Dongle Installation	14
Ethernet Connection.....	15
Expansion Microphone Installation (Optional).....	15
Expansion Speakerphone Installation (Optional)	16
Operating the Camera	17
Make a Video Call	17
Make a Connection through the Browser.....	17
Web Settings	20
First Time Login.....	20
Live Screen Operation	21
Set up the Preset.....	22
Camera Settings.....	24
Tracking Mode	24
Framing Speed.....	25
Framing Size.....	25
Home Position.....	28
Save Preset	29
Image Settings	30

Image Flip	30
Image Mirror.....	30
True WDR	30
Frequency	30
White Balance.....	30
Noise Reduction.....	31
Brightness	31
Sharpness.....	31
Saturation.....	31
Low Light Compensation	31
Low Resolution under 720p	31
Enlarge Total Zoom Up to 15x	32
Video Frame Rate.....	32
RS232	32
Video Format Settings.....	34
H.264 Profile	34
IP Stream Resolution	34
Frame Rate	34
Bit Rate	35
RTSP.....	35
RTMP	36
Network Settings	37
Hostname.....	37
Network.....	37
System Settings	38
Language	38
Firmware Update	38
Factory Default.....	39
Camera Reboot.....	39

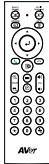
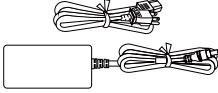
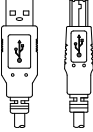
Change Password.....	40
SSL Certificate	41
Displaylink.....	41
Date Format	41
Time Format.....	41
Information	43
Audio Settings	44
Noise Suppression.....	44
Beamforming Microphone.....	44
Echo Cancellation	45
Keyboard Noise Suppression	45
Phone In Jack	45
PTZApp 2.....	46
Install PTZApp 2.....	46
Use PTZApp 2 with USB Devices	46
Smart Gallery Operation.....	54
EZLive	57
Use AVer EZLive	57

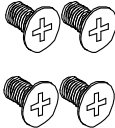
Package Contents

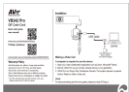
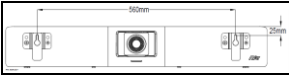
<p>VB342 Pro Unit</p>	<p>Remote Control</p>	<p>Power Adaptor & Power Cord*</p>	<p>USB 2.0 Type-B to Type-A Cable (5m)</p>
			
<p>USB Type-A to Type-C Adapter</p>	<p>Wall Mount Kit</p>	<p>Screws (x4) for Wall Mount</p>	<p>Tripod Screw (x3)</p>
			
<p>QR Code Card</p>	<p>Drilling Paper</p>		
			

*The power cord will vary depending on the standard power outlet of the country where it is sold.

Optional Accessories

<p>Expansion RJ-45 wired microphone 10m/20m (Cable is included)</p>	<p>Expansion RJ-45 wired Speakerphone 10m/20m (Cable is included)</p>	<p>USB 3.1 Extender 10m/20m/30m</p>	<p>HDMI Cable</p>
-------------------------------------------------------------------------	---------------------------------------------------------------------------	-------------------------------------	-------------------

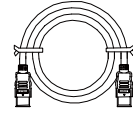
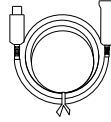
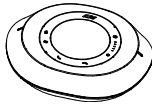

<p>USB 3.0 Type-B to Type-A Cable (3m)</p>	<p>Din6 to RS232 Adapter</p>	<p>BT Dongle</p>	<p>Audio-out Converter</p>
--------------------------------------------	------------------------------	------------------	----------------------------

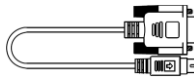

TV VESA Mount Kit

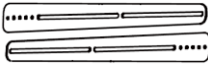

*Optional Accessories will vary depending on the country where it is sold.

Product Introduction

Overview

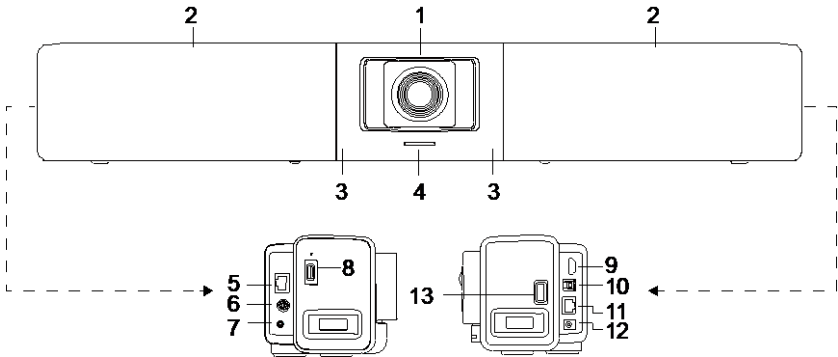

- | | |
|----------------------------------------------------------|---------------------------------------------------|
| (1) Lens | (7) Phone In/Audio Out Port* |
| (2) Microphone Array Area
(10 Built-in Microphones) | (8) USB 2.0 Type A Port**
(only for BT Dongle) |
| (3) IR Sensor | (9) HDMI Output Port (to TV) *** |
| (4) LED Indicator | (10) USB 3.0 Type B Port (to PC) |
| (5) Expansion Audio
(for Speakerphone/
Microphone) | (11) RJ-45 Ethernet Port |
| (6) RS232 Port | (12) DC 12V Power Jack |
| | (13) USB 2.0 Port**** |

* The default is phone in function. To support audio out function for HA system, please set it up via PTZApp 2 and purchase audio-out convert (TRS female to TRRS male) from AVer.

** BT dongle is an optional item in certain countries. Please contact your local dealer for purchasing.

*** Support DisplayLink technology.

**** If using MAC latest Monterey OS version and want to use this USB 2.0 port, please don't use USB extender cable, otherwise, MAC PC can't detect the VB342 Pro and system instability issue may occur.

LED Indicator

Power on: Blink blue once

Start-up: Solid red

Power on completely but no USB connection: Solid orange

Power and USB cable connected but device is idle or a call on hold: Solid white

Video and audio on: Solid blue

Calling: Fast blink white or blue depending on original status

Video on and audio mute (During a call): Solid red

A second calling: Fast blink white, blue, or purple depending on original status

Gesture control

Blue light blinks for 2 seconds: Successfully wake up gesture control function by any valid gesture command.

Blue light blinks for 4 seconds: Camera recognizes a valid gesture command and start to action.

[Note] The default of gesture control is off. Please enable it via PTZApp 2 or IP web page. The effective distance is up to 5-meter away from the camera.

Wall Mount Installation

1. Attach the Drilling Paper to the wall and mark the two screw holes on the wall. Screw the support screws to the wall. Leave some space between the wall and screws for hanging the camera on the wall later.

[Note] Please prepare two screws (not included in the package) for hanging the camera on the wall. Use anchors if necessary.

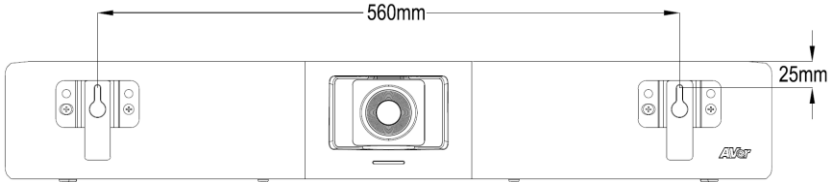

2. Use the supplied four Wall Mount Screws to secure the supplied two Wall Mount Kits to the rear panel of the camera.

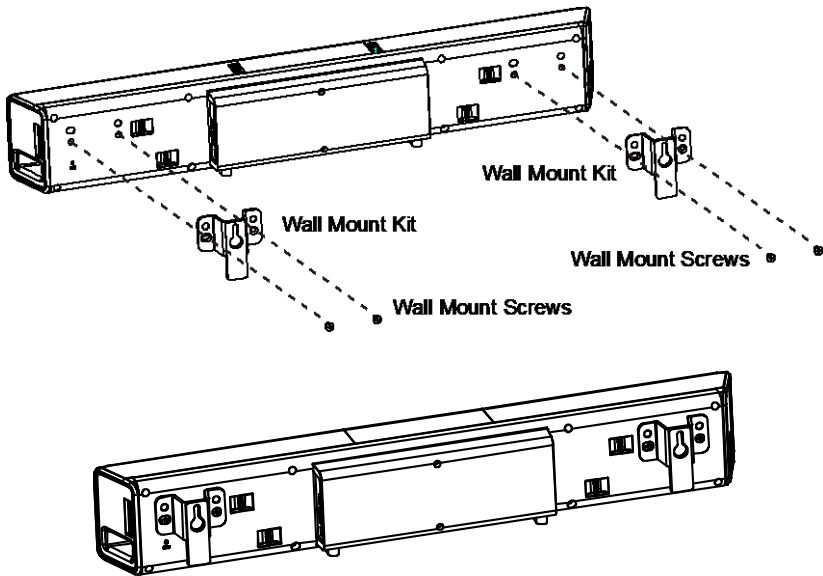









3. Align the mounting holes on the Wall Mount Kit with the two screws on the wall and hang the camera on the wall.

TV VESA Mount Installation (Optional)

Package Contents:



- | | |
|---------------------------------------------------------------------------------------------------|-------------------------------------------------------------------------------------------------------|
|  Screw(M5*10) x 2 |  Silicone washer x 2 |
|  Screw(M6*15) x 4 |  Metal washer x 2 |
|  Screw(M6*20) x 4 |  Washer(M6) x 4 |
|  Screw(M8*20) x 4 |  Washer(M8) x 4 |
|  Screw(M8*30) x 4 | |

1. Fix the screw (M5*10) with silicone washer in suitable holes (1~5).

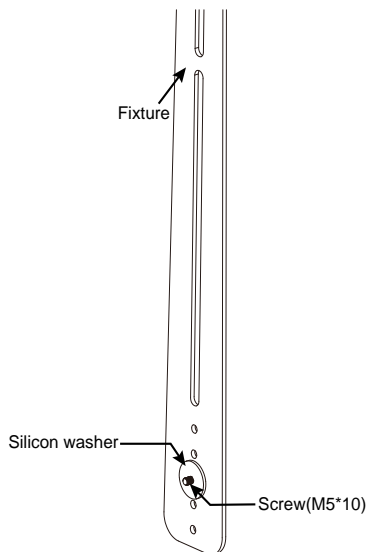

2. Secure the fixture on the rear side panel of the camera. Don't screw tight at this stage. You can select among the four screw holes for screwing the fixtures.

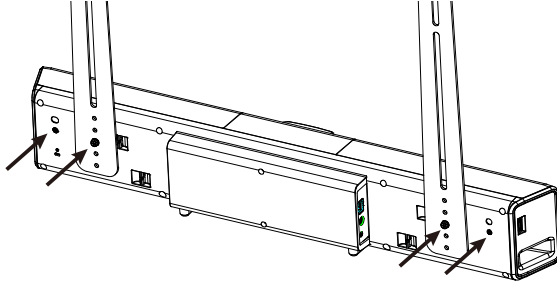

3. Place the metal washers on the mount holes of TV.

[Note] If users do not need to install the mount rack of TV, just skip step 3 to 5 and go to step 6.

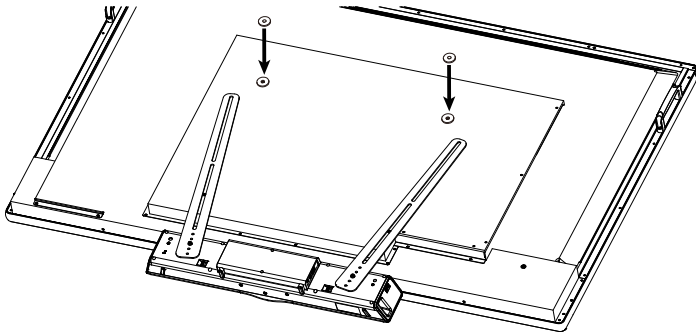

4. Place mount rack of TV on top of fixture.

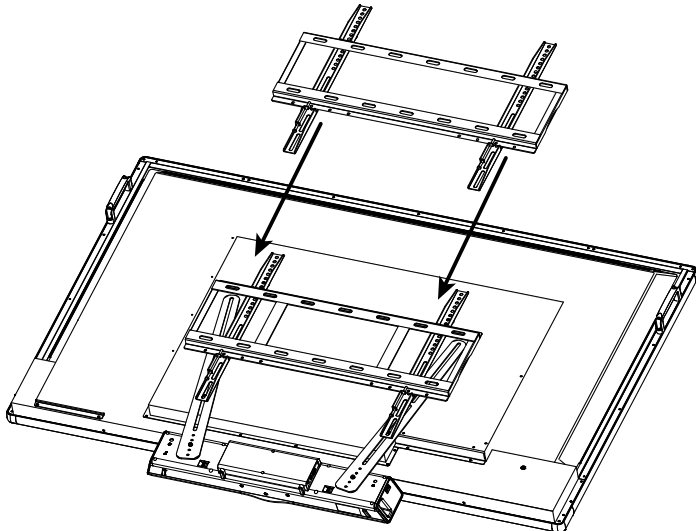

5. Secure the mount rack and fixture on the TV. Please do not screw tight at this stage. Then, adjust the mount rack and fixture to an appropriate position if needed. Finally, tightly screw all screws.

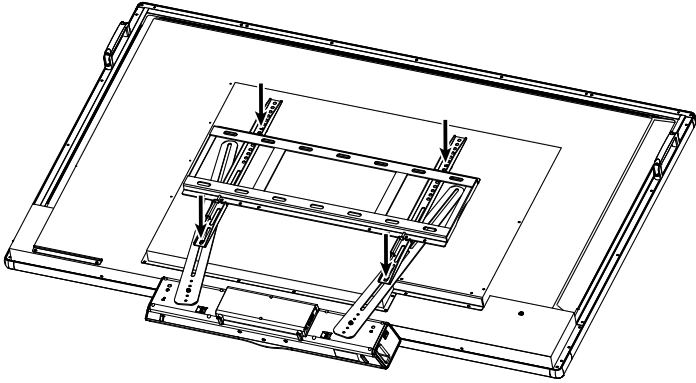

6. If users don't need to install mount rack of TV, then, secure the fixture on the TV. Then, adjust the fixture to an appropriate position if needed. Finally, tightly screw all screws.

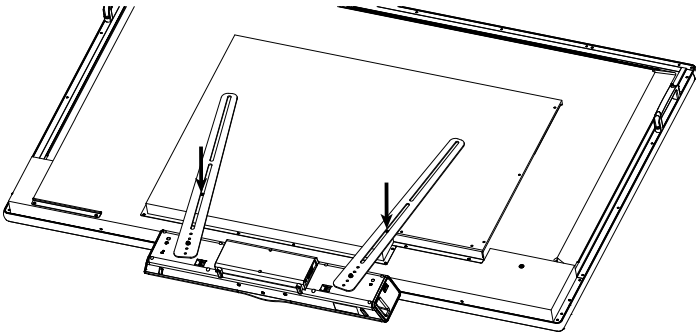

7. The camera can be mounted on top or bottom of the TV. Both ways of installation are the same and please follow the steps described above.

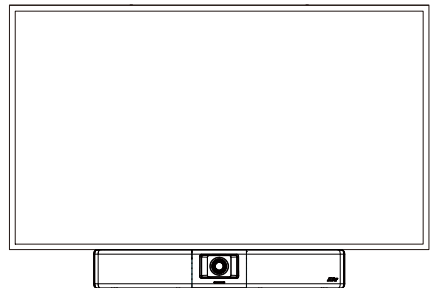
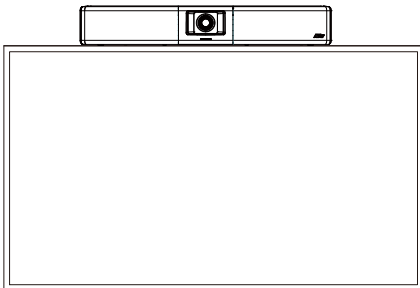

Remote Control

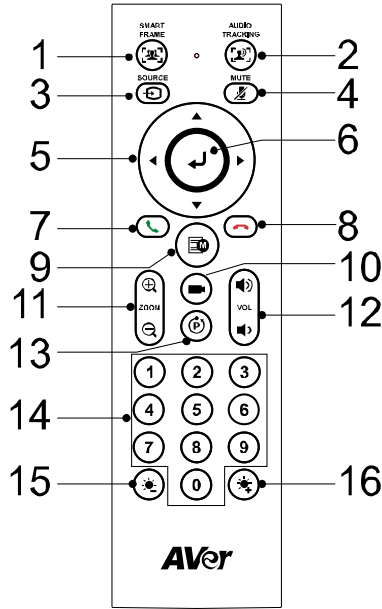

Name	Function
------	----------

1. SmartFrame

One-click automatic FOV adjustment to fit all participants in screen for one time. Press and hold the button for 1~2 sec to switch from manual to auto framing mode or Off.

An icon message (as figure shown) will display on the left upper screen to indicate in SmartFrame status. The icon will appear 2~3 sec on the screen. Once the process is done, it will disappear. If you don't want to see the icon display, please go to PTZApp 2 or Web setting, find "On Screen Menu" function and select "Off".



[Notes]

- SmartFrame deploys face and body detection technology. People wearing masks or in side facial profiles can still be detected. The maximum detection distance is 7~8 meters.
- Camera will track people while moving. It will start to focus and zoom in when people stop moving anymore for 1~5 seconds, depending on the framing speed you set up in PTZApp 2 or web page. The default framing speed is "Middle" speed. "High" speed is more suitable for one person tracking.

Name	Function
------	----------

2. Audio AI Control

Press and hold the button for 1~2 sec to switch modes among Audio tracking, Presentation mode, Audio fence and Off.

An icon message (as figure shown) will display on the left upper screen to indicate in Audio AI status. If you don't want to see the icon display, please go to PTZApp 2 or Web setting, find **"On Screen Menu"** function and select **"Off"**.



: Audio tracking and presentation mode



: Audio fence

[Notes]

- ✓ **Audio tracking:** Camera pans/tilts (ePTZ) until speaker is centered before zooming in. The camera moving path will be shown in the screen. Audio tracking supports up to 7~8m distance away from the camera.
- ✓ **Presentation mode:** This is a combination function of preset tracking and audio tracking. Please set up preset areas (preset 1~9. Preset 0 is for home position) in the PTZApp 2, IP web page, or remote control first. When someone speaks within this area, camera shoots this area. When someone speaks outside of this area, camera will track this person in view and zoom in. If there is no more sound and no person's face is detected outside of this area after the idle time (based on the idle time interval set up in PTZApp 2), the camera will shoot on the last triggered preset area again.



- ✓ **Audio fence:** Microphone only picks up the sound within viewing angle. Adjust the camera viewing area via PTZApp 2 or IP web page to silence the sound beyond the meeting area.

[Note] All the AI tracking functions, pan, tilt, and zoom in/out will be disabled while audio fence is on.

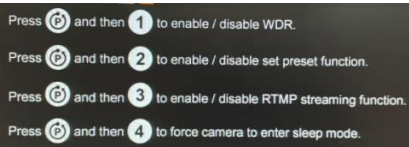
3. Bluetooth	<ul style="list-style-type: none"> ✓ To start using the Bluetooth function, ensure to power-off the camera and then plug-in the BT dongle to the USB port on the camera. After that, power-on the camera. ✓ Short press it again to disconnect Bluetooth. <p>[Note] BT dongle is an optional item. Please contact your local dealer for purchasing.</p>
4. Mute/Unmute	Mute/Unmute the speakerphone.
5. Camera Directional Control	Use the directional button on the remote to control the direction of the camera. Press the directional button to move the camera or press and hold for continuous pan or tilt.
6. Enter	Press to show the current AI function on screen such as Auto Framing. When pressing this button, it will also force camera to do manual focus for once at the same time.
7. Call/Answer	Answer a call or start a call.
8. End Call	End the call.
9. OSD Menu	Short press to pull out gesture control guide.
10. Load Preset Hotkey	Press to move to preset position as user has set in sequence.
11. Zoom In/Zoom Out	Increase/Decrease the camera zoom.
12. Volume Up/Down	Adjust volume up or down.
13. Compound Key	<ul style="list-style-type: none"> ■ When pressing this button, the following photo will show up. Then press the corresponding number key for setting up specific function.  <ul style="list-style-type: none"> ■ WDR: Press (P) then (1) to enable/disable the WDR function. ■ Set Preset: Press (P) then (2) to enable/disable the Set Preset function. ■ RTMP: Press (P) then (3) to enable/disable the RTMP streaming function. ■ Sleep Mode: Press (P) then (4) to force camera to enter sleep mode. If there is USB streaming, this function won't work.
14. Number Buttons/Preset Position	<ul style="list-style-type: none"> ■ Long press the number button to set the preset point. ■ One-click the number button to load the preset point.
15. Brightness -	■ Press this button to decrease image brightness level.
16. Brightness +	■ Press this button to increase image brightness level.

Installation

Device Connection

1. Connect VB342 Pro to PC/laptop with provided USB 2.0* cable and connect the power cord of VB342 Pro to power wall outlet.

[Note] Use the supplied Velcro strap to secure and manage the cable.

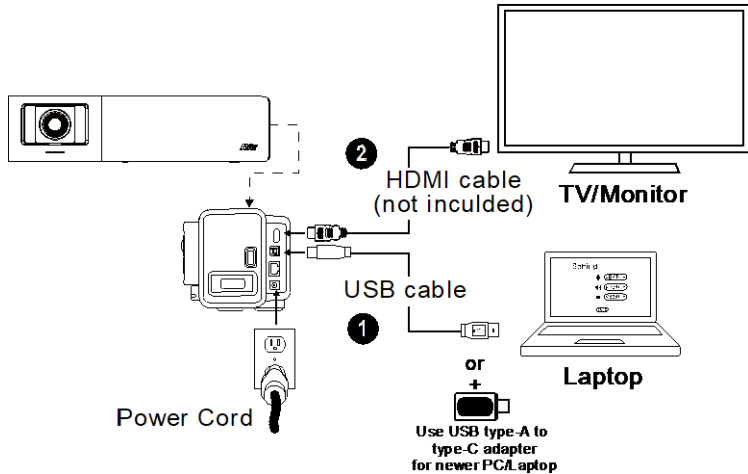

2. Connect TV/HDMI monitor to VB342 Pro through the HDMI cable.

[Note] For Windows® 7 OS, a Displaylink driver is required for the TV/Monitor connection with VB342 Pro. Please use PTZApp 2 to install Displaylink driver.

On the PTZApp 2, go to System setting. In the “Install Displaylink” field, click the “Start” button and follow the on-screen instructions to install Displaylink.



*Resolution & frame rate for USB 2.0 and USB 3.1 connection:

USB 2.0		USB 3.1	
YUV	M-JPEG	YUV	M-JPEG
- 640x480 or less resolution, up to 30fps - 720p, up to 10fps	- Up to 4k/30fps - 1080p/60fps	- Up to 1080p/30fps - 720p/60fps	- Up to 4k/30fps - 1080p/60fps

■ Zoom ratio vs video resolution

Resolution	Maximum zoom in/out ratio
4K	3x ; doesn't support AI function
1080p/60fps	6x
1080p/30fps	12x
720p or lower	15x

BT Dongle Installation

Use VB342 Pro as mobile phone's external audio device

When using mobile phone to have a video call, user can connect their mobile phone to VB342 Pro via Bluetooth wireless connection to enjoy crystal clear audio quality.

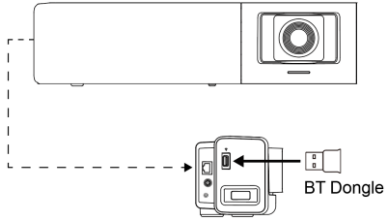

Install a BT dongle before powering up the device. Plug it into the USB 2.0 type-A port. Use remote control or PTZApp 2 to enable Bluetooth function.

Ethernet Connection

VB342 Pro supports ethernet connection which allows user to access VB342 Pro from remote site through browser. Web accessing please refer to "[Make a Connection through the Browser](#)".

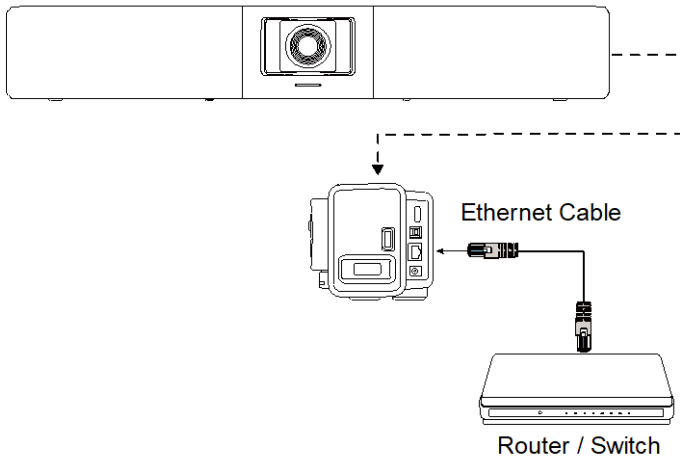

Expansion Microphone Installation (Optional)

Users can purchase the expansion microphone from AVer.

The expansion microphone can expand the sound received and controlled of audio, mute and unmute.

[Note] Cable is included with optional expansion microphone. There are two lengths of cables - 10m and 20m.

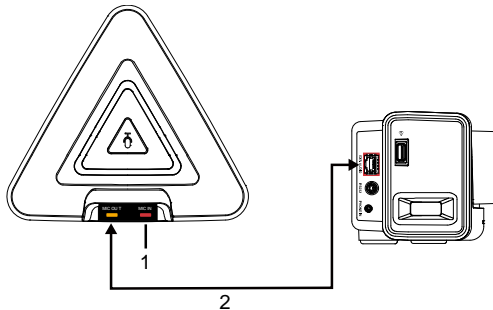

1. The port won't be used while using with AVer video bar, such as VB342 Pro and VB350. It doesn't support daisy chain connection.
2. Connect the provided RJ45 cable to MIC Out and connect the other side of RJ45 cable to side of video bar.

Expansion Speakerphone Installation (Optional)

Users can purchase the expansion speakerphone from AVer.

The expansion speakerphone can expand the sound received and controlled of audio, mute and unmute.

[Note] Cable is included with optional expansion speakerphone. There are two lengths of cables - 10m and 20m.

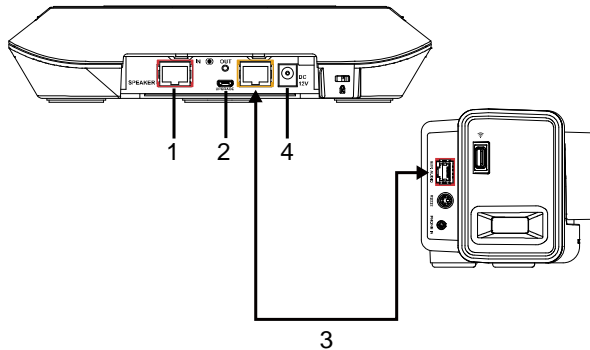

1. The port won't be used while using with AVer video bar, such as VB342 Pro and VB350. It doesn't support daisy chain connection.
2. Micro USB port: while upgrading speakerphone FW, please find a micro USB cable and connect to PC. Launch AVer PTZApp 2 to upgrade FW.
3. Connect the yellow head of the provided RJ45 cable to speakerphone. Connect the red head to side of video bar.
4. Connect the provided DC power adapter.

Operating the Camera

Make a Video Call

1. Make sure all devices (VB342 Pro, laptop/PC, TV/monitor) are well connected and powered on.
2. Run your video application (Teams, Skype™, Skype for Business, Google Hangouts™, Zoom™, WebEx™, Adobe Connect™, WebRTC, etc.) on your laptop/PC.
3. Set the VB342 Pro camera as the primary camera and speakerphone for your video application (refer to your video application user guide). You can now make your call.

[Note] The VB342 Pro is a plug-and-play conference camera. The system requires no special drivers, but we do recommend installing the PTZApp 2 for a better user experience. For information on how to install and use the PTZApp 2, refer to the PTZApp 2 section in this user manual.

Make a Connection through the Browser

VB342 Pro has an Ethernet port for IP streaming and allows administrators to remotely control and set up the camera via an internet access. Moreover, VB342 Pro also supports RTSP and RTMP functions. For more details, please refer to page 30~31 or contact our technical support.

[Note] When USB streaming is on, RTSP/RTMP functions will not work.

1. Make sure the VB342 Pro has an internet access connection.
2. Launch PTZApp 2* () and connect VB342 Pro to PC with USB cable. The camera default IP address is **192.168.1.168**.



[Note] The browser supports:

- Chrome: version 76.x or above
- Firefox: version 69 or above
- IE: Doesn't support

3. Click pencil icon (✎) to edit IP address**.

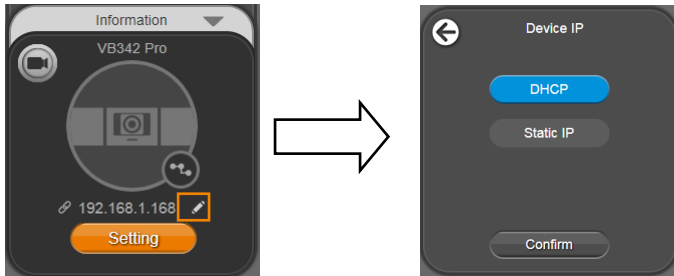

4. Click weblink icon (🔗) to launch Chrome page. Please enter the password (default password is **aver4321**). User will be asked to set a new account and password. (Please enter PTZApp 2 to reset password back to default while password is forgotten.)

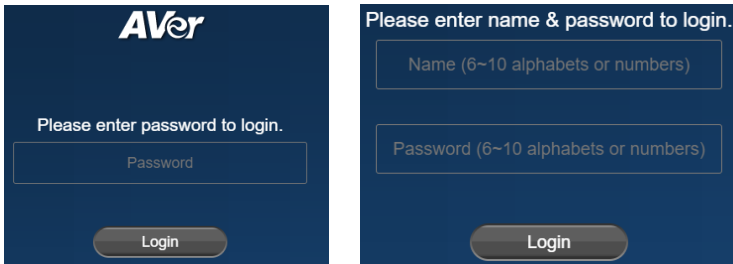

5. After editing IP address, user can access web settings of the camera with only Ethernet cable connection. Unplug the USB cable.
6. The main web screen is displayed as below.

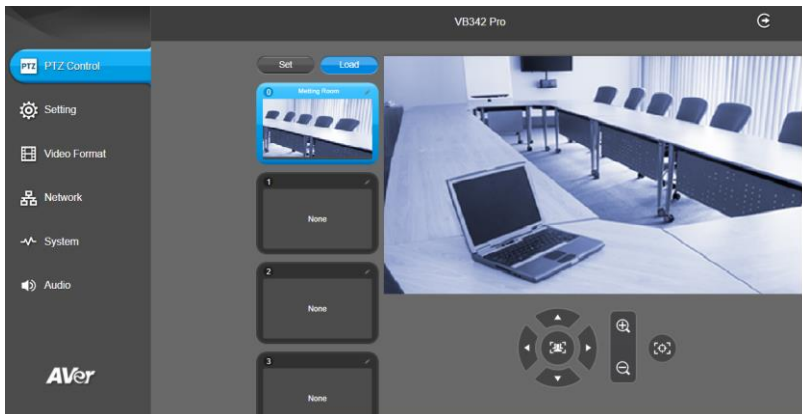

* For information on how to install and use the PTZApp 2, refer to the PTZApp 2 section in this user manual.

** To support IP address changes in groups, user can download AVer IP Finder app.

1. Download the IP Finder from <https://www.aver.com/download-center> (Global & European Headquarters) or <https://www.averusa.com/business/support> (USA).
2. Run the IP Finder.
3. Click **“Search”**, and all available devices will be listed on the screen.
4. Select a camera from the list. The corresponding fields of IP address will display.
5. To change the IP address of camera, user can select **“DHCP”** or **“Static IP”**.

The DHCP should get the IP address from local dynamic IP sever. The static IP, user can enter the specific IP address. Click **“Apply”** to apply the setting to the camera. The password is required (default password is **aver4321**).

6. Click **“Search”** button to re-scan the camera.
7. Double-click on the IP address of camera from the list to connect to camera through the browser.
8. Enter the default password (**aver4321**) to log in to Web setup screen.

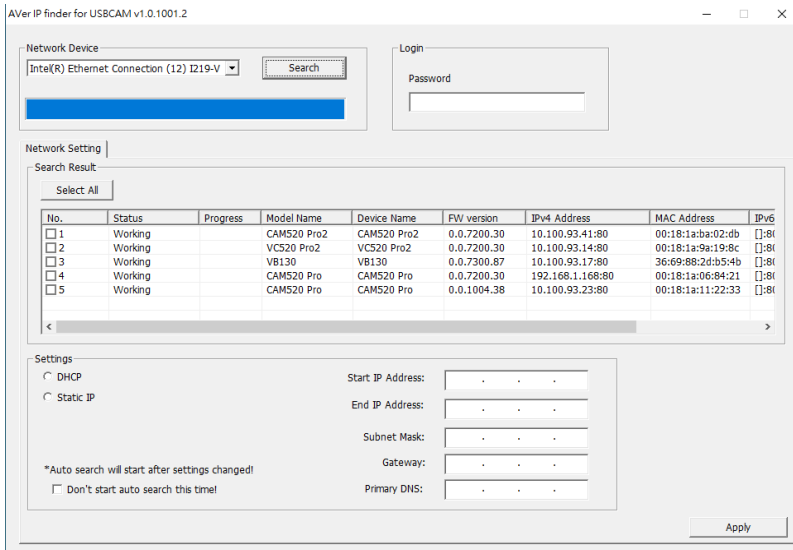

Web Settings

VB342 Pro supports Ethernet connection; users can enter the IP address into the web browser to connect to the camera for detail settings.

First Time Login

To find the IP address of the camera; please refer to “**Make a Connection through the Browser**” section.

1. Open the browser on your laptop/PC and enter the IP address of the camera.
2. Enter the password at login screen. The default password is “**aver4321**”.
3. The main web screen is displayed.

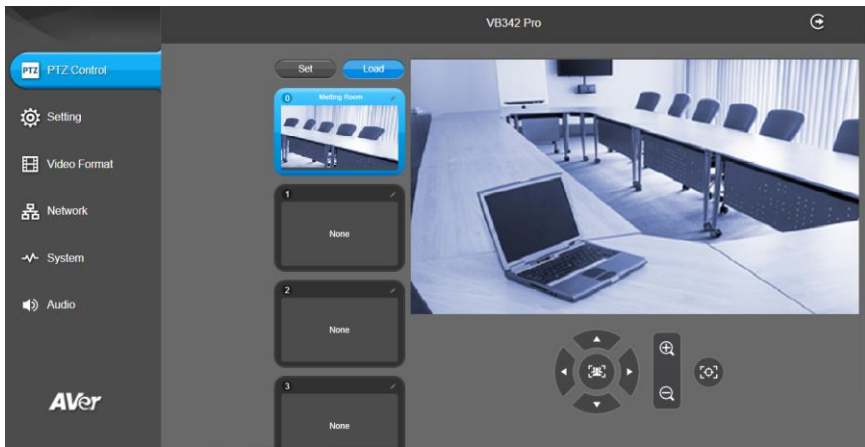

Live Screen Operation

User can control the camera direction, zoom in/out, and set preset position.

[Note]

1. The system will force the previous login to log out, when there is a second login.
If the web page is idle without any request for more than 4 hours, user will be logged out.
2. The resolution of live screen is 848x480/ 5fps.
3. When enabling 4K USB streaming, the live preview on IP web page is not available.

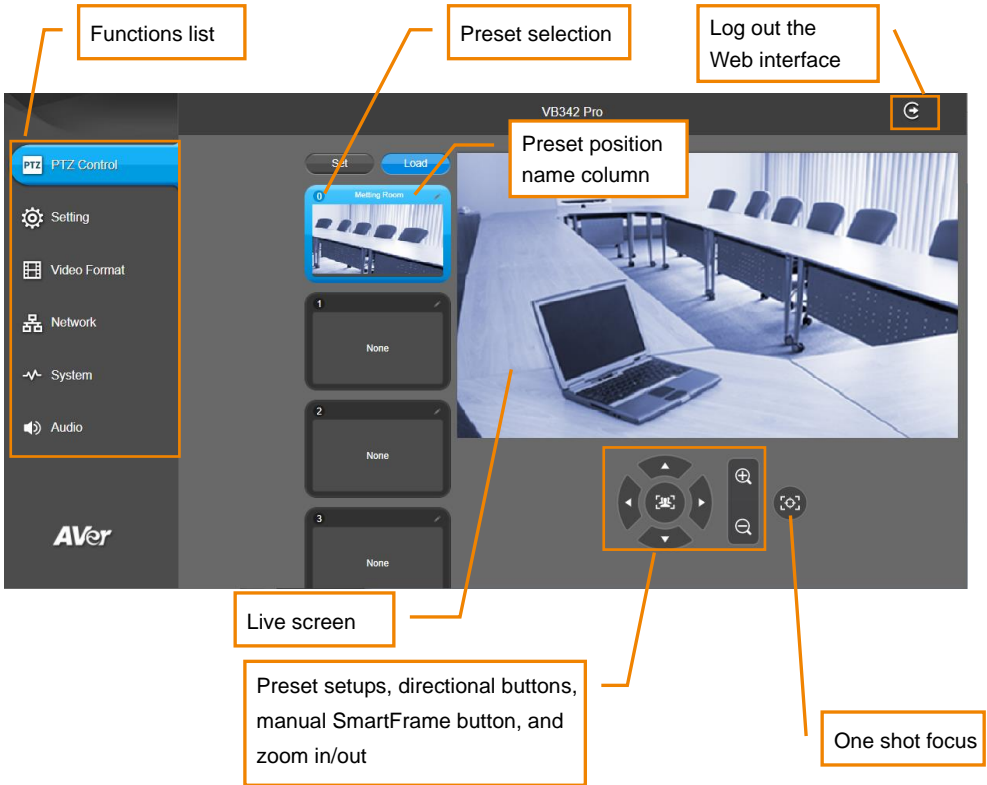

Set up the Preset

User can set 10 preset positions.

1. In live screen, use mouse to scroll up or down and click the preset number frame (0~9).
2. Use ▲, ▼, ◀, ▶ and zoom in/out buttons to adjust the camera screen view to desired position.
3. Click “Set” and then click on a preset number (0~9), if you want to save this position to the selected preset number, click “Yes”. The system will capture the preset screen view and display in preset number frame.

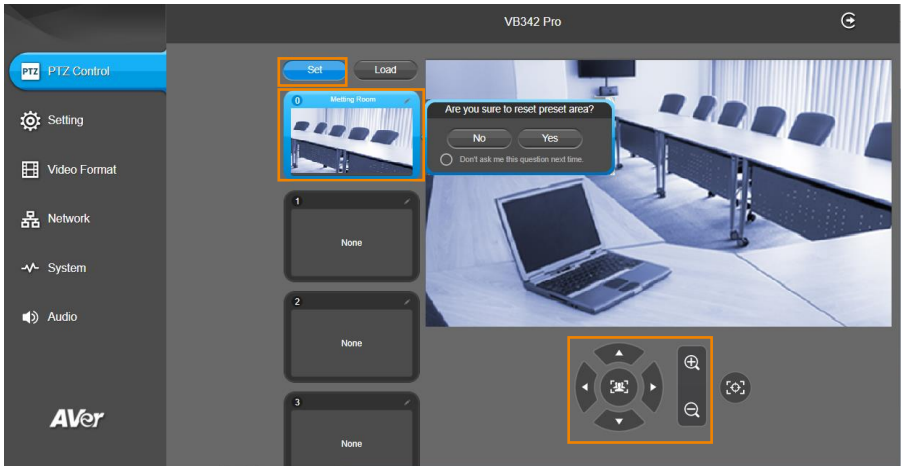

4. Click the  icon to edit name of preset frame.

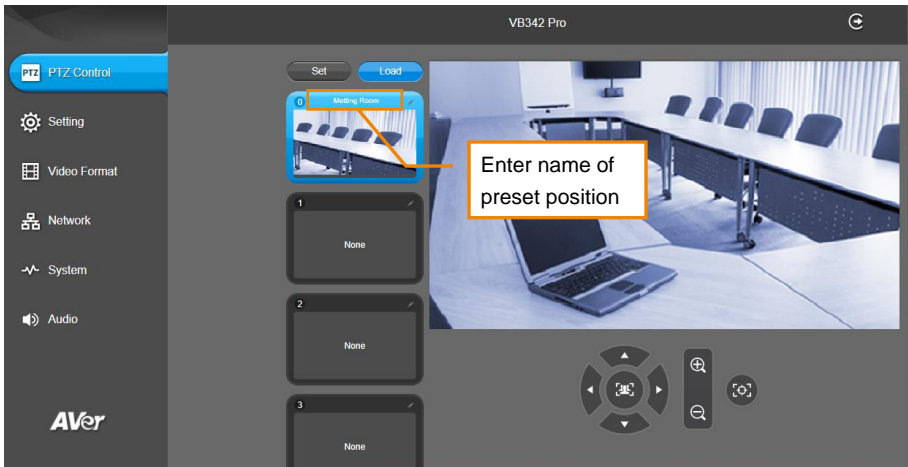

5. To set another preset, repeat the above steps.
6. After setting up the preset positions, you can start performing the function. Click the “Load” button and then click on the preset numbers, the live screen will move to the preset screen view.

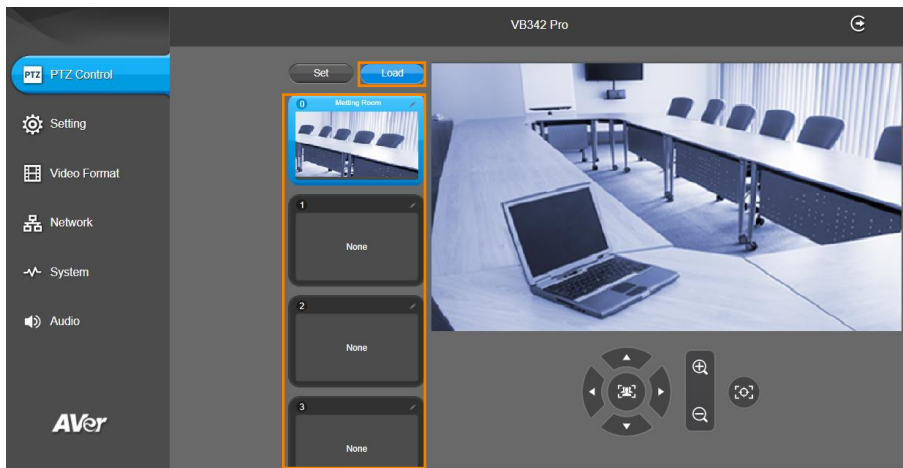

Camera Settings

The video  icon is to turn on camera live view while doing any settings.



Tracking Mode

Select **Setting > Camera > Tracking Mode > Off, Manual Frame, Auto Frame, Audio Tracking or Presentation Mode.**

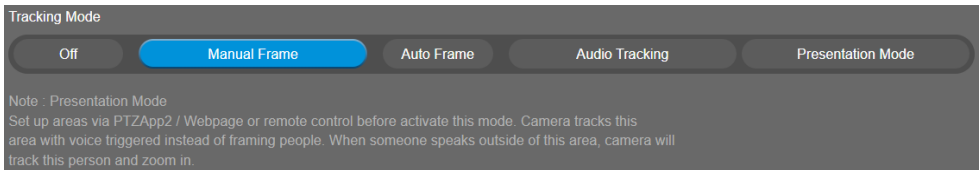

- **Off:** Tracking mode is disabled.
- **Manual Frame:** User one-click SmartFrame button and camera will adjust view angle to fit all participants in screen for once.
- **Auto Frame:** Camera automatically adjusts view angle to frame all participants on screen every time it detects participants' faces or bodies. This action will be activated once people in the room sit or stand still for 1~5 seconds, depending on the framing speed you select.* Once all the participants are in frame, the camera will keep the image stable by not completing any action until subjects move in or out of the screen. When a participant touches the sides of the screen or enter the lens field of view, it will trigger the camera and automatically track, detect, and frame all the participants again.
*The default framing speed is "Middle" speed. "High" speed is more suitable for one person tracking.

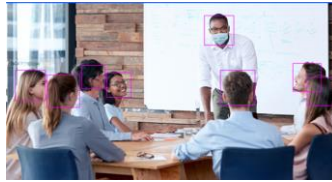

[Note] VB342 Pro frames people in masks or any facial profile up to 7~8 meters away!

- **Audio Tracking:** After detecting the sound, camera focuses at the speaker and zooms in. The camera moving path will be shown in the screen.

Presentation Mode: This is a combination of preset tracking and audio tracking. Please set up preset areas (preset 1~9. Preset 0 is for home position) in the PTZApp 2, IP web page, or remote control first. When someone speaks within this area, camera shoots this area. When someone speaks outside of this area, camera will track this person in view and zoom in. If there is no more sound and no person's face is detected outside of this area after the idle time (based on the idle time interval set up in PTZApp 2), the camera will shoot on the last triggered preset area again.

Framing Speed

Select **Setting > Camera > Framing Speed > Slow Speed, Middle Speed** (default) or **High Speed**.

When in auto framing mode, camera will automatically frame people if they stand still without moving for 1~5 seconds.

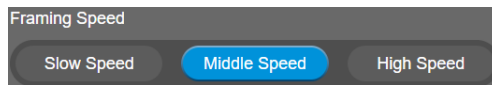

- **Slow Speed:** camera starts to frame people if they don't move for 5 seconds.
- **Middle Speed:** camera starts to frame people if they don't move for 3 seconds.
- **High Speed:** camera starts to frame people if they don't move for 1 second.

[Note] High Speed is more suitable for one person tracking.

Framing Size

Select **Setting> Camera> FramingSize > Tight, Medium or Wide**.

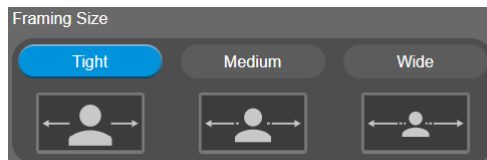

- **Tight**(default): It provides a close-up view of meeting participants.
- **Medium:** It provides a medium view of meeting participants.
- **Wide:** It provides a wide view of meeting participants.

Smart Frame Preset Point

Select **Setting > Camera > Smart Frame Preset Point > Central Of The Screen Image, Preset 0, Preset 1, Preset 2, Preset 3, Preset 4, Preset 5, Preset 6, Preset 7, Preset 8 or Preset 9.**

This is to assign camera's capturing area to do manual framing. For audio tracking function, when the audio tracking idle time is up, the camera will go to this assigned preset area to frame all people.

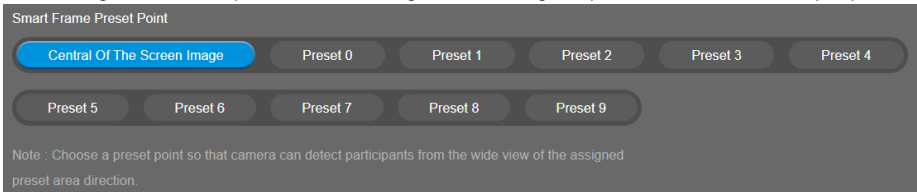

Audio Tracking Idle Interval

Select an idle interval for audio tracking.

Select **Setting > Camera > Off, 15 sec, 30 sec, 40 sec, 50 sec or 60 sec.**

When setting up idle time, if there is no more human sound up to the idle time, the camera will go back to SmartFrame preset point (default at camera central view) to frame all the people. If selecting Off, the camera will stay at the final shot even though there is no more sound being detected.

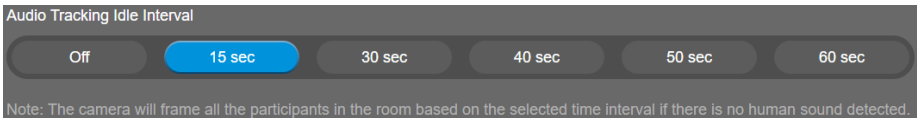



Gesture Control

Select **Setting > Camera > Gesture Control > On or Off.**

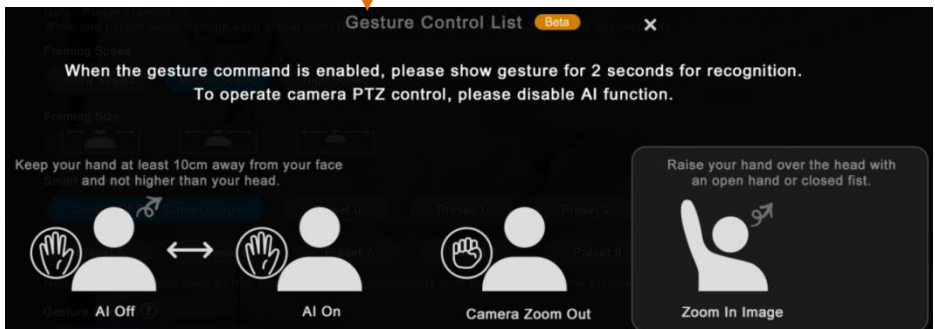
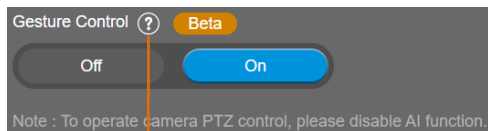
Enable gesture control allows user to use hand to control camera for turning on/off tracking function, zooming in/out. Click “?” icon to show gesture control list on screen.

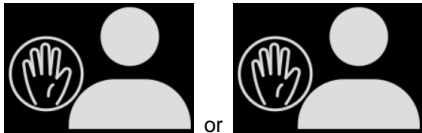

Turn on gesture control function first. When any of the following gestures are showing in front of the camera, it will activate gesture control function. Keep showing the gesture for 2~3 seconds to trigger the camera to act. The following are the corresponding function names and gesture figures.

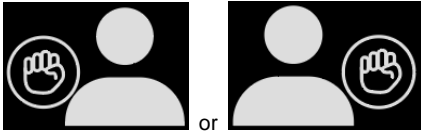
Gesture Control	Description
<p>Tracking On/Tracking Off</p> 	<p>Raise the palm of your hand to face the camera and place it on the side of your face (not over the head) for 2~3 seconds to activate or disable tracking function. Your hand has to be at least 10cm away from your face.</p> <p>Turn off tracking function before doing zoom in/out function.</p>
<p>Zoom In</p> 	<p>Raise your hand over your head for 2~ 3 second to zoom in camera. If there are more than one people raising the hand, the camera will follow the 1st one until he puts down the hand.</p> <p>Turn off tracking function before doing zoom in/out function.</p>
<p>Zoom Out</p> 	<p>Place a fist with palm facing the camera on the side of the face for 2~3 seconds to activate the zoom out. Your hand has to be at least 10cm away from your face.</p> <p>Turn off tracking function before doing zoom in/out function.</p>

Audio Fence

Turn on the Audio Fence function and then configure the settings in the Audio Fence Mode field below. Select **Setting > Camera > Audio Fence > On** or **Off**.

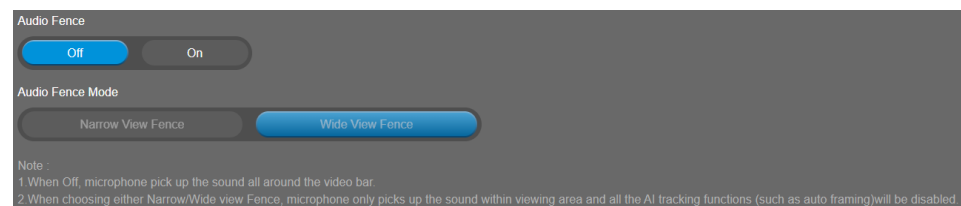

After turning on the Audio Fence function, you can further set up the Audio Fence Mode. Select **Setting > Camera > Audio Fence Mode > Narrow View Fence** or **Wide View Fence**.

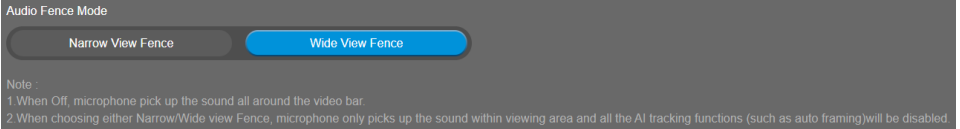

Microphone only picks up the sound within viewing angle. Choose a suitable camera viewing area to silence the sound beyond the meeting area.

[Note] All the AI tracking functions, pan, tilt, and zoom in/out will be disabled while audio fence is on.



Auto Focus

Set auto focus mode.

First select **Setting > Camera > Camera Focus > Auto**.

Select **Setting > Camera > Auto Focus > PTZ** or **Continuous**.

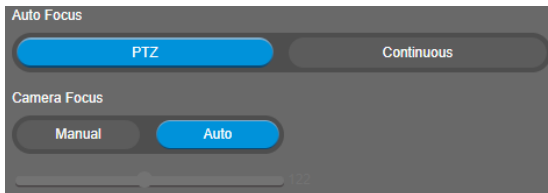

Camera Focus

Set auto/manual focus mode.

Select **Setting > Camera > Camera Focus > Auto** or **Manual**.

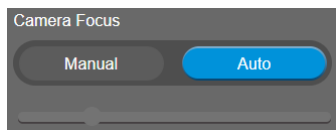

- **Auto:** Camera adjusts focus automatically.
- **Manual:** You can adjust the camera focus by moving the control bar below.

Home Position

Every time when powering on the camera, it will turn to this position.

Select **Setting > Camera > Home Position > Last Operating Position, Factory Center Position, or Preset 0**.

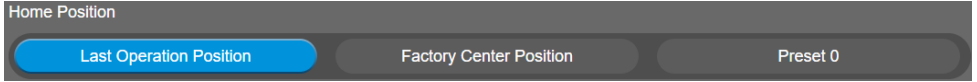

Sleep Position

When the camera idles for certain period, it will enter sleep mode and go to the sleep position. Please set up sleep timer to enable sleep mode.

Select **Setting > Camera > Sleep Position > Factory Downside Position or Preset 9.**



Sleep Timer

Set the camera idle time to enter sleep mode. When entering sleep mode, the camera will turn to sleep position.

Select **Setting > Camera > Sleep Timer > Off, 10 sec, 5 min, 10 min or 20 min.**

Please notice that whenever there is USB streaming or RTSP/RTMP streaming, the camera won't enter sleep mode.

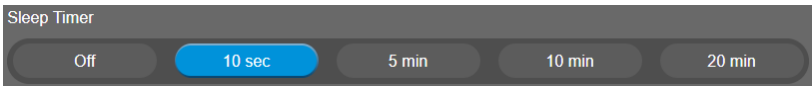

On Screen Menu

Enable/disable on screen display status information.

Select **Setting > Camera > On Screen Menu > Off, On, or Load Preset Off.**

[Note] Under **Off** mode, **Load Preset**, **Save Preset** and **AI** icons will not be displayed on the screen.

Under **Load Preset Off** mode, only the **Load Preset** icon will not be displayed on the screen.



Save Preset

Enable/disable "save preset" function. When applicable, IT personnel can limit end-user access to change preset points by locking "save preset" function and switching this function off.

When off, user can't save preset points via IR remote, Hot key, VISCA, web page and PTZApp 2.

Select **Setting > Camera > Save Preset > Off or On.**

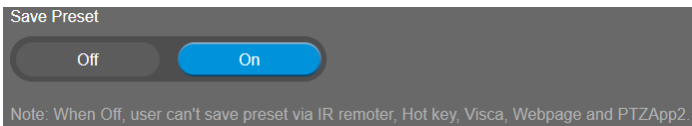

Image Settings

Image Flip

If the VB342 Pro is installed in the upside down position, please enable the "Flip".
Select **Setting > Image > Image Flip > Off or On.**



Image Mirror

To mirror the camera image.
Select **Setting > Image > Image Mirror > Off or On.**



True WDR

In back light environment, enable WDR to improve the brightness of image.
Select **Setting > Image > True WDR > Off or On.**

The frame rate will be limited to 30FPS while WDR is on.

If user enables this function in a normal light condition, the image will become over exposure and encounter image blur.

When WDR is enabled, camera has taken long exposure and user cannot manually adjust the brightness of image.

[Notes] When USB streaming is off, you may encounter image blur issue while using web page to see camera live preview. In this case, please disable WDR function to solve it.



Frequency

Select the frequency of the camera.
Select **Setting > Image > Frequency > 50 HZ or 60 HZ.**



White Balance

Select the White Balance setting for various light conditions or color temperature.
Select **Setting > Image > White Balance > Auto or Manual.**

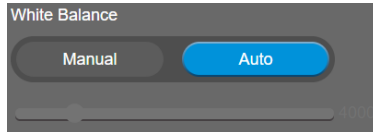

Noise Reduction

To reduce the noise from the signal.

Select **Setting > Image > Noise Reduction > Off, Low, Middle or High.**



Brightness

Adjust the value of brightness.

Select **Setting > Image > Brightness > 1 ~ 9.**



Sharpness

Adjust the value of sharpness.

Select **Setting > Image > Sharpness > Off, Low, Middle, or High.**



Saturation

Adjust the value of saturation.

Select **Setting > Image > Saturation > 1 ~ 9.**



Low Light Compensation

Enable/disable the compensation in low light environment.

Select **Setting > Image > Low Light Compensation > Off or On.**

Please notice that the frame rate will drop to 10~15 fps.

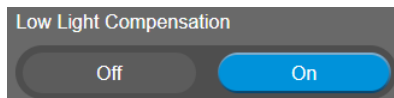

Low Resolution under 720p

Enable/disable to lower down the resolution under 720p.

Select **Setting > Image > Low resolution under 720p > Disable** or **Enable**.

Low resolution under 720p (except 848 *480)

Disable

Enable

Note :

1. While disable/enable low resolution, the system will reboot automatically and it will take around 20 seconds. Please wait.
2. In some video conference software, such as Teams, they may get lower resolution (360p) video streaming from camera to lower down the bandwidth loading during video call.

If you'd like to get better image quality during video call, please disable the output of resolution under 720p. The side effect will be lower frame rate, depending on different software providers.

Enlarge Total Zoom Up to 15x

Enable/Disable enlarge zoom up to 15x.

Select **Setting > Image > Enlarge Total Zoom Up to 15x > Disable** or **Enable**.

Enlarge Total Zoom Up To 15x

Disable

Enable

Note: 15x zoom is available for 720p or lower resolution.

Video Frame Rate

Set up the frame rate value.

Select **Setting > Image > Video Frame Rate > 30 FPS** or **60 FPS**.

30fps is with much better image quality than 60fps. Unless you want to shoot fast moving objects, please use 30fps.

Video Frame Rate

30Fps

60Fps

Note :

1. 30Fps supports better image quality.
2. It will take around 20~60 seconds to reboot system, depending on different models.

RS232

When the camera connects with PTZ camera controller through the RS232 port, please setup **ADDR**, **Baud Rate**, **Protocol**, and **Visca Over IP** settings.

Select **Setting > RS232**.

RS232

ADDR

1

2

3

4

5

6

7

8

Baud Rate

2400

4800

9600

115200

Protocol

Visca

Pelco-P

Pelco-D

Visca Over IP

Off

On

Video Format Settings

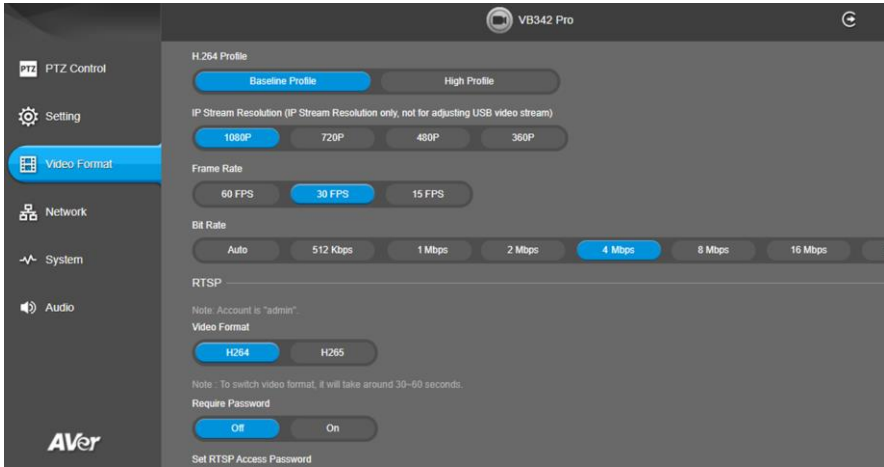

H.264 Profile

While in live broadcasting, user can choose preferable profile to get best streaming quality.

Select **Video Format > H.264 Profile > Baseline Profile** or **High Profile**.

[Note] RTSP, RTMP will not be available while USB streaming is in use.



IP Stream Resolution

Set up the resolution for IP stream. Not supported for USB video stream.

Select **Video Format > IP Stream Resolution (IP Stream Resolution only, not for adjusting USB video stream) > 1080P, 720P, 480P or 360P**.

[Note] RTSP, RTMP will not be available while USB streaming is in use.

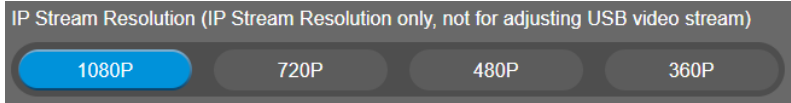

Frame Rate

Set up the frame rate value.

Select **Video Format > Frame Rate > 60 FPS, 30 FPS or 15 FPS**.

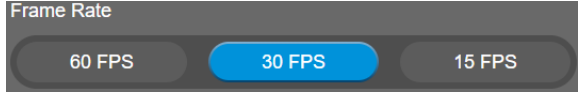

Bit Rate

Set up the bit rate value.

Select **Video Format > Bit Rate > Auto, 512 Kbps, 1 Mbps, 2 Mbps, 4 Mbps, 8Mbps, 16Mbps or 32 Mbps.**

For Facebook live broadcasting, it's suggested to choose less than 4Mbps to ensure smooth streaming.



RTSP

To use RTSP player connecting to the camera, please enter the RTSP URL which displays on the web in your application such as VLC, PotPlayer or Quick Time.

Select **On/Off** to enable/disable password requirement while opening RTSP.

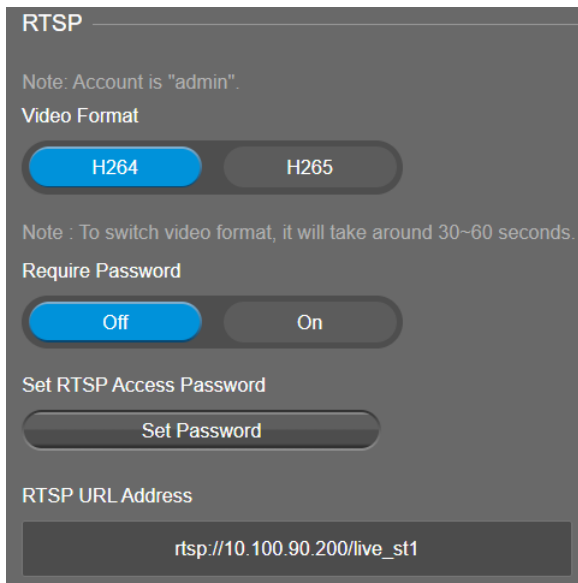
A configuration screen titled "RTSP" with a dark grey background. It contains the following elements:

- A note: "Note: Account is 'admin'."
- A "Video Format" section with two buttons: "H264" (highlighted in blue) and "H265".
- A note: "Note : To switch video format, it will take around 30~60 seconds."
- A "Require Password" section with two buttons: "Off" (highlighted in blue) and "On".
- A "Set RTSP Access Password" section with a "Set Password" button.
- An "RTSP URL Address" section with a text input field containing the URL "rtsp://10.100.90.200/live_st1".

Set RTSP Password

1. Select **Video Format** > **RTSP** > **Set RTSP Access Password** > **Set Password**.
2. Enter the new password.
3. Select **Change** to save the new password.

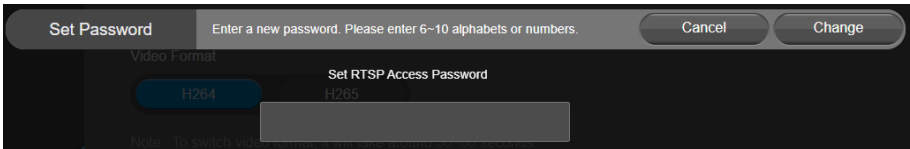
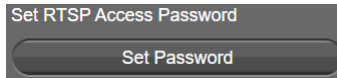

RTMP

Set up for uploading the camera's live view to the broadcasting platform (e.g. YouTube).

Select **Video Format** > **RTMP**.

1. Locate the RTMP server URL and stream key from the broadcasting platform and enter in **Server URL** and **Stream Key** fields.
2. Select **Start** to begin uploading the live video of the camera to the broadcasting platform.
3. Select **Stop** to stop uploading the video.

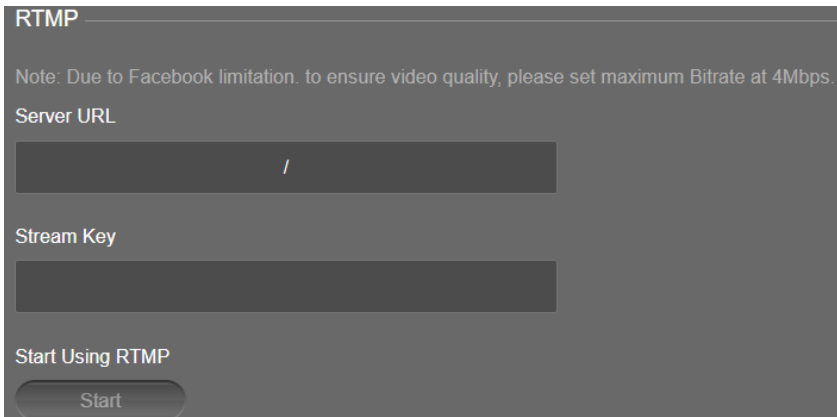

Network Settings

Hostname

User can set a hostname. The hostname only allows numeric and alphabetic characters.

Select **Network > Hostname**. Click pencil icon to enter hostname.

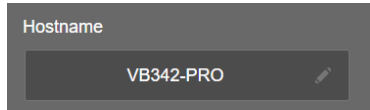

Network

Select **Network > Static IP** or **DHCP**.



■ **Static IP:** Assign a fixed IP address to the camera.

1. Select pencil icon and enter **IP Address**, **Gateway**, **NetMask**, and **DNS** in the corresponding fields.
2. Select **Confirm** to complete the setting.

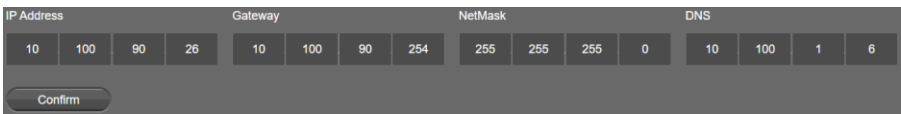
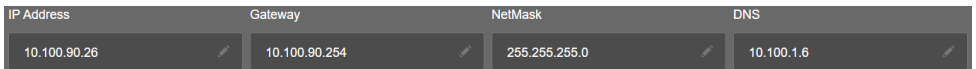

■ **DHCP:** Enable DHCP function.

System Settings

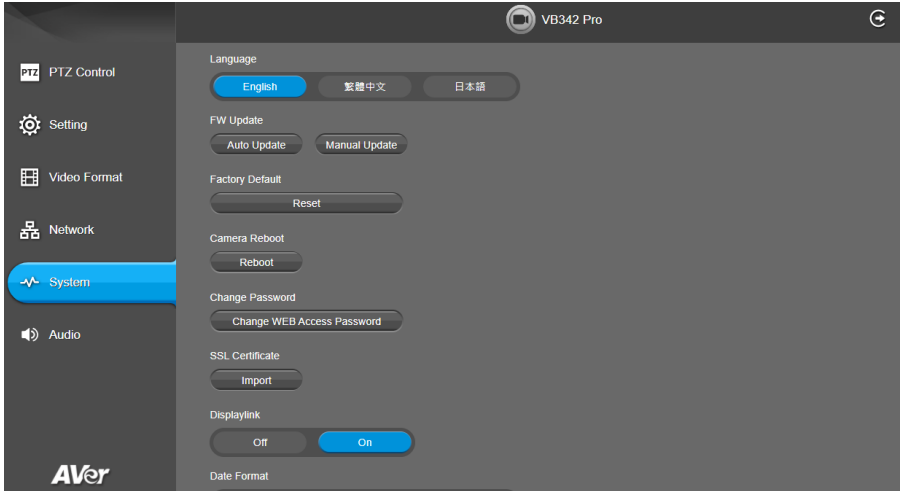

Language

Select the language of the system.

Select **System > Language > English, Traditional Chinese, or Japanese.**

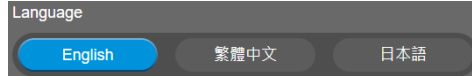

Firmware Update

Update the camera's firmware.

Select **System > FW Update > Auto Update or Manual Update.**



- **Auto Update:** The system will check firmware version from AVer server and request to update.
- **Manual Update:** To update the firmware from specific location.

After updating, the camera will **reboot** and the connection will be lost. Please wait for few minutes and always keep the power cable connected. If unplugging the power during this process, it will cause damage of the device.

Factory Default

Reset the camera back to factory default setting.

1. Select **System** > **Factory Default** > **Reset**.
2. User can choose to keep current IP address or back to default.
3. Select **Continue** to reset back to factory default.

[Note] When factory default is activated, the password of web page login will not be set to default. For security concerns, to reset password of web page access, please download PTZApp 2 to reset it.

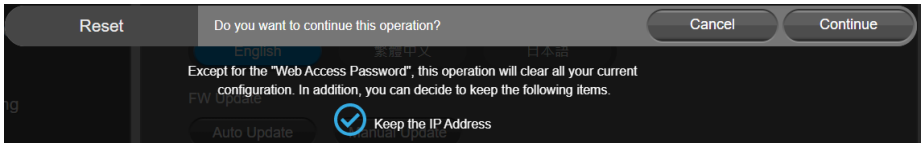
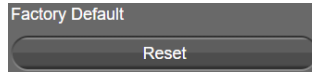

Camera Reboot

Restart the camera manually.

1. Select **System** > **Camera Reboot** > **Reboot**.
2. Select **Continue** to reboot the camera.

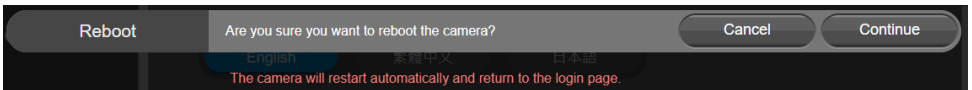
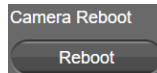

Change Password

Change the Web login password. The default password is “**aver4321**”.

1. Select **System** > **Change Password** > **Change WEB Access Password**.
2. Enter the old account and password. Select **Continue**.
3. Enter the new account and password. Select **Continue** to save the new setting.
4. If users forget the password and want to revert back to the default password, please use PTZApp 2 to reset it.

A screenshot of the "Change Password" screen. The title bar says "Change Password" and the subtitle is "Please enter old name & password for change." There are "Cancel" and "Continue" buttons. Below the subtitle, there is a "Reset" button and two input fields: "Name" and "Password".A screenshot of the "Change Password" screen. The title bar says "Change Password" and the subtitle is "Please change new name & password for login." There are "Cancel" and "Continue" buttons. Below the subtitle, there are two input fields: "Name (6~10 alphabets or numbers)" and "Password (6~10 alphabets or numbers)".

SSL Certificate

Import the SSL certificate from specific location.

1. Select **System > SSL Certificate > Import**.
2. Select the type by clicking “+”.
3. Direct the file location.
4. Select **Import**.

[Notes] Users can disable this function via PTZApp 2.

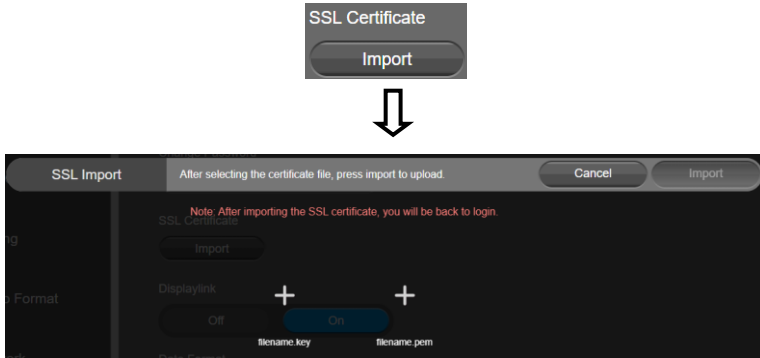

Displaylink

The HDMI output port on the right-side panel supports Displaylink technology. By default, the Displaylink function is set as on.

Select **System > Displaylink > Off** or **On**.



Date Format

Select the date format.

Select **System > Date Format > yyyy-mm-dd**, **mm-dd-yyyy**, or **dd-mm-yyyy**.

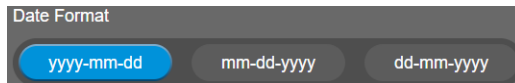

Time Format

Set up the time format.

Select **System > Time Format > 24-Hour** or **12-Hour**.



Time Correction Mode

Adjust time by auto or manual.

Select **System** > **Time Correction Mode** > **Auto** or **Manual**.

- **Auto:** The system time will be set by NTP server on the network. Select the pencil icon of NTP Server and enter the URL of NTP server. Select the **Time Zone**. Select **NTP Update** to save setting. Select **Confirm** to start auto time adjustment.

[Note] Our default NTP server is located in the USA. If this does not work in your country, please manually key in the desired NTP server.

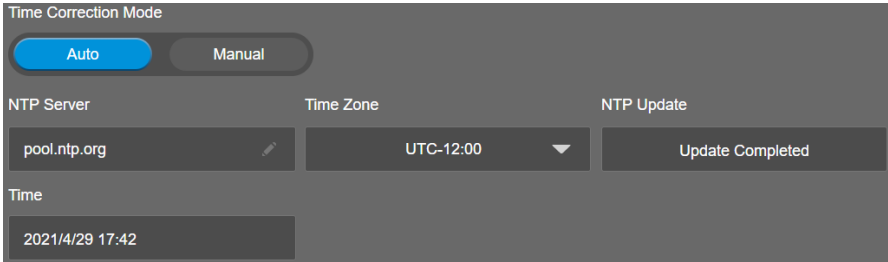

The screenshot shows the 'Time Correction Mode' interface. At the top, there are two buttons: 'Auto' (highlighted in blue) and 'Manual'. Below this, there are three main sections: 'NTP Server' with the value 'pool.ntp.org' and a pencil icon; 'Time Zone' with a dropdown menu showing 'UTC-12:00'; and 'NTP Update' with a button labeled 'Update Completed'. At the bottom, there is a 'Time' section showing '2021/4/29 17:42'.

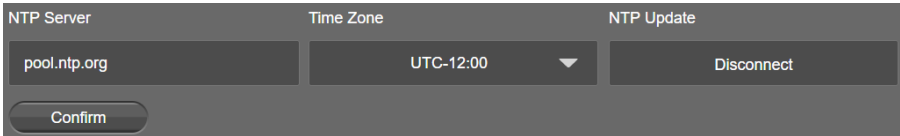

This screenshot is similar to the previous one, but the 'NTP Update' button is now labeled 'Disconnect'. The 'Confirm' button at the bottom left is highlighted in blue, indicating it is the next step to be clicked.

- **Manual:** User can set up time manually. Select the pencil icon and enter the **Year**, **Month**, **Day**, **Hour**, and **Minute**. Select **Confirm** to save the settings.

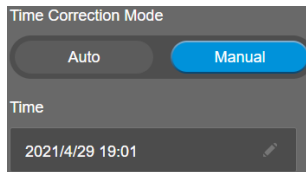

The screenshot shows the 'Time Correction Mode' interface with 'Manual' selected. The 'Time' section shows '2021/4/29 19:01' with a pencil icon to its right.

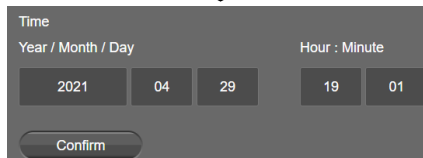

This screenshot shows a detailed manual time selection interface. It has a 'Time' section with 'Year / Month / Day' and 'Hour : Minute' labels. The year is '2021', month is '04', day is '29', hour is '19', and minute is '01'. A 'Confirm' button is at the bottom.

Information

Display the information of **Model Name**, **Firmware Version**, **Serial Number**, **IP Address**, and **MAC Address**.

Select **System > Information**.

Information		
Model Name	Firmware Version	Serial Number
VB342 Pro	0.0.7800.14	51003748000
IP Address	MAC Address	
10.100.90.15	00:18:1A:FB:AC	

Audio Settings

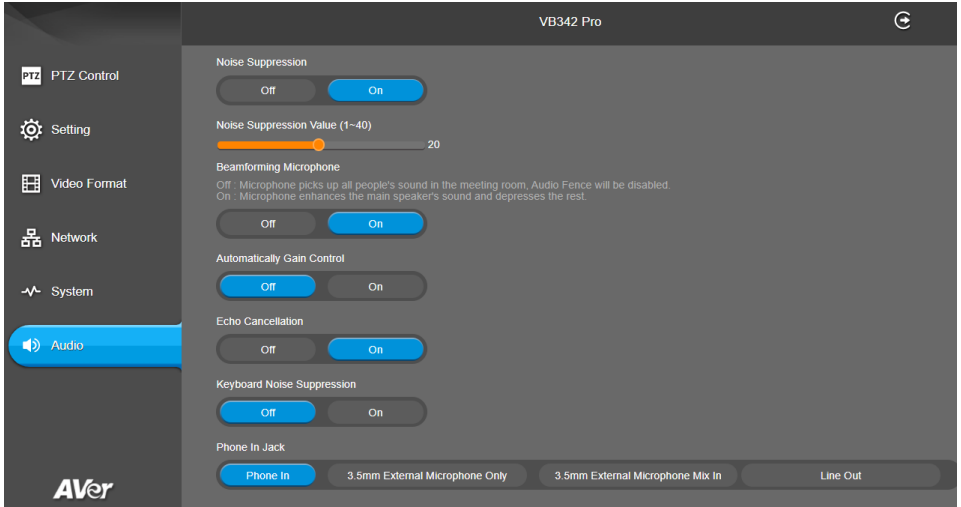

Noise Suppression

It is to reduce ambient noise.

Select **Audio > Noise Suppression > Off or On.**

When enabling the noise suppression function, please set value of noise suppression (1 ~ 40).



Beamforming Microphone

Enable/disable the beamforming microphone.

Select **Audio > Beamforming Microphone > Off or On.**

- **Off:** Microphone picks up all people's sound in the meeting room, Audio Fence will be disabled.
- **On:** Microphone enhances the main speaker's sound and depresses the rest.

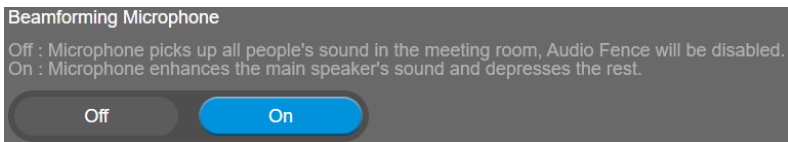

Automatically Gain Control

Enable/disable the auto gain control. It is to control ambient sound level and maintain a suitable output, despite variation of the one at the input.

Select **Audio > Automatically Gain Control > Off or On.**

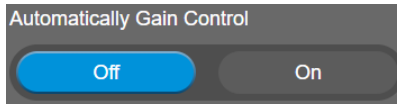

Echo Cancellation

Enable/disable echo situation.

Select **Audio > Echo Cancellation > Off or On.**

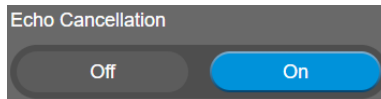

Keyboard Noise Suppression

Enable/disable keyboard noise reduction.

Select **Audio > Keyboard Noise Suppression > Off or On.**

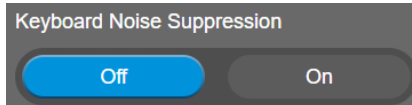

Phone In Jack

The camera provides a Phone In Jack on the left-side panel. Users can also configure the Phone In Jack to support 3.5mm audio input, Line Out or hybrid audio input for both Line In and 3.5mm audio input.

[Note]

1. Line Out function is mainly designed for connecting to HA system. Users have to purchase an audio-out adapter from AVer (TRS female to TRRS male).
2. If Line Out is selected, please don't connect to external speaker, otherwise the speaker sound will have impact on built-in speaker and microphone performance.

Select **Audio > Phone In Jack > Phone In, External Microphone Only, External Microphone Mix In or Line Out.**

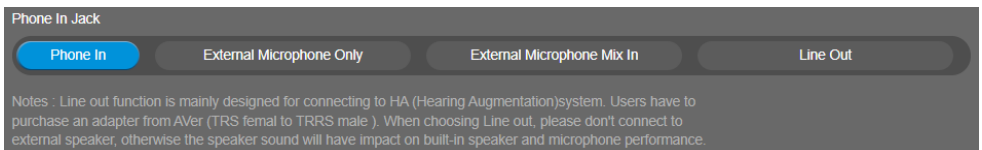

PTZApp 2

In PTZApp 2, user can change the IP address setting of VB342 Pro, configure the parameters of the camera, set up AI tracking functions and some advanced image and audio settings, pan, tilt, and zoom the camera.

Install PTZApp 2

Please go to <https://www.aver.com/download-center> (Headquarters & European) or <https://www.averusa.com/business/support> (USA) to download the PTZApp 2. After downloading, double-click on the file and follow the on-screen instructions to complete the installation. After installing the PTZApp 2, double-click on the PTZApp 2 icon to run the application.

Use PTZApp 2 with USB Devices

1. Run your video application and make a video call.
2. During your video call, you can use the PTZApp 2 to pan, tilt and zoom the camera in/out and enable/disable the true WDR, brightness, and sharpness feature.
3. Launch PTZApp 2 () and it will open in Chrome browser automatically.

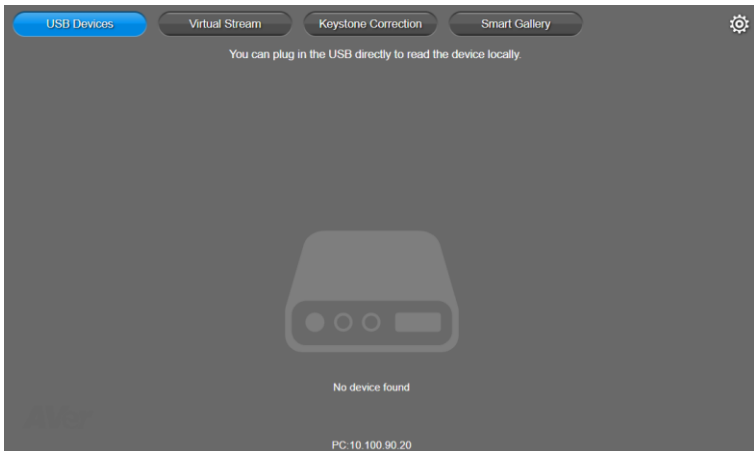

4. Choose "USB Devices" and connect VB342 Pro to PC/laptop with USB cable. When the camera is detected, the product card will show up.

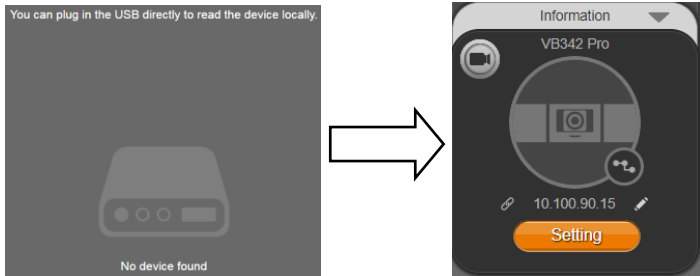

5. Set up IP address. The camera default IP address is 192.168.1.168. Click pencil icon (✎) to edit IP address.

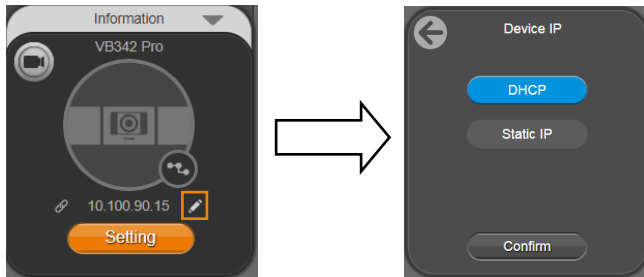

6. Click the setting icon to change Language, Hotkey Control, and PTZApp 2 Version.

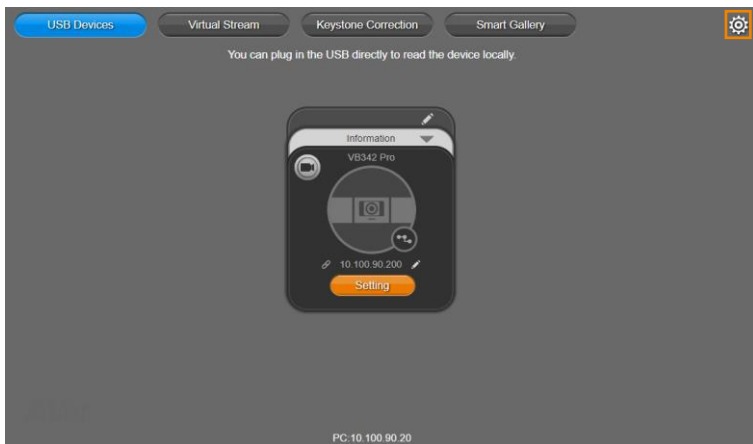

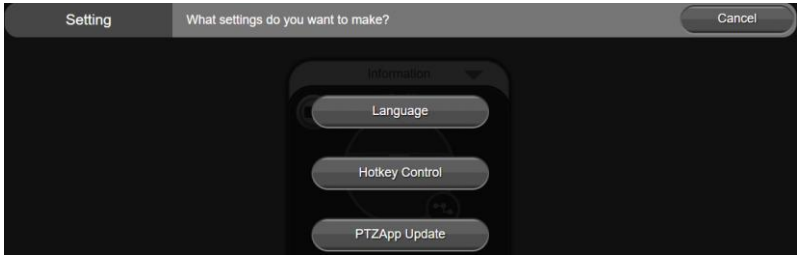

- Language:** Select desired language and click the check icon to confirm the selection.



- Hotkey Control:** User can control the camera by using keyboard. This is a general list for all Aver USB Cameras. Backlight control equals to WDR function in VB342 Pro

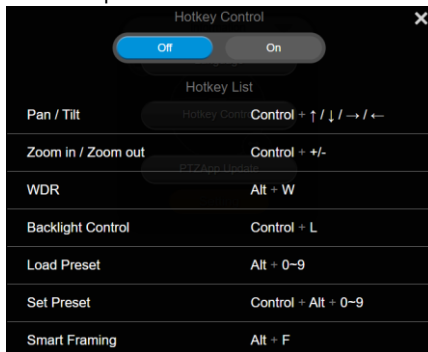

- PTZApp Update:** Get current PTZApp 2's version number and do auto update here.

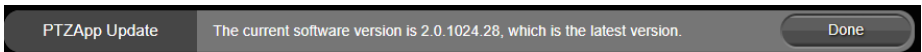



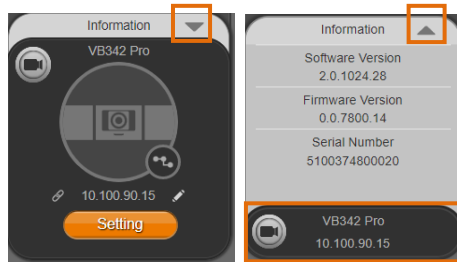

7. **Information:** Click the drop-down triangle icon to review the information of camera. To minimize the information, click the triangle or the bottom area of the information icon.



8. **Camera:** Click the camera icon to view the camera live view. IP address is displayed as well. Click the X icon to close the camera live view. If the live video did not appear, please check the camera and the laptop/PC connection to make sure all are correct and well connected.

The resolution of this small live view is 640x480 resolutions.



- **Full Screen:** PTZApp 2 can switch to full screen mode. Click “ ” icon and video screen will switch to full screen mode. In full screen mode, user can use direction panel to control camera direction. Click “ ” icon to go back to normal screen view. The resolution of full screen mode is 1080p/ 30fps.

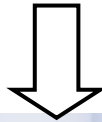
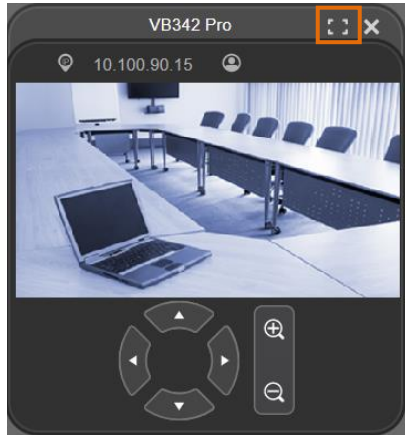

- **People Count and Stream Interval:** Click the  icon to show people count number and USB stream interval. Click the  or  icon to hide the stream interval.

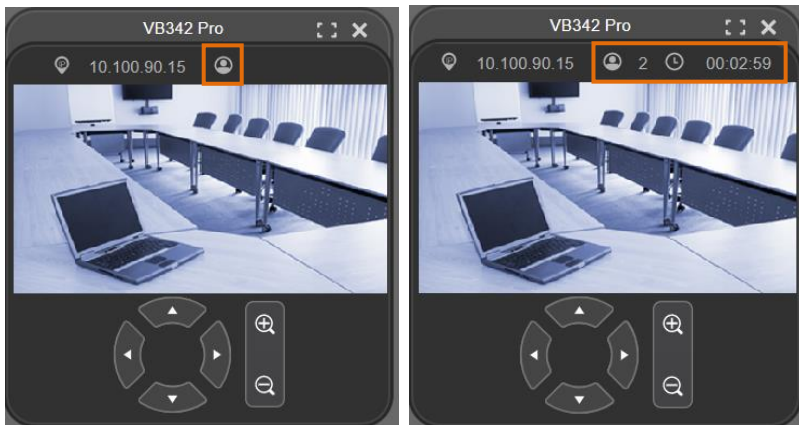

- **Control Panel:** To control the camera direction, zoom in and out during your video call.

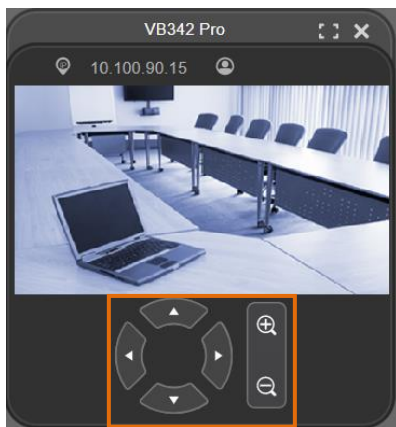

9. **Setting:** Click “**Setting**” button to set up parameters of the camera and speakerphone. Click arrow icon to leave the Setting page.

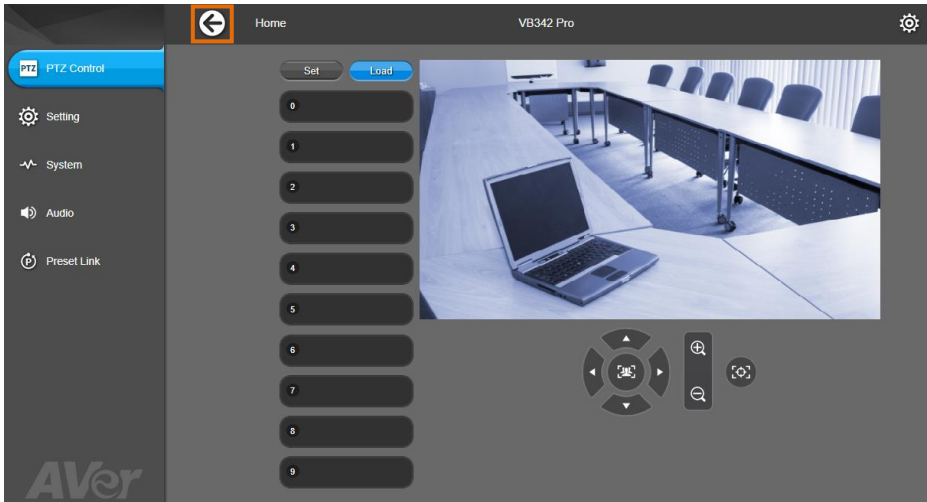
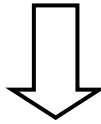
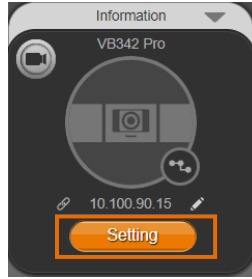

- **PTZ Control:** Use control panel to set up preset positions. Since most of operations are the same as web page, refer to [Set up the Preset](#) section (page 21) for detailed setup.
- **Setting:** To set up parameters of the camera. Since most of operations are the same as web page, refer to [Camera Settings](#) and [Image Settings](#) section (pages 23~33) for detailed setup.
- **System:** To setup system. Since most of operations are the same as web page, refer to [System Settings](#) section (pages 37) for detailed setup.
- **Audio:** To setup audio parameters. Since most of operations are the same as web page, refer to [Audio Settings](#) section (pages 43) for detailed setup.

The following items are different from web page in System.

- **I/O Port:** Except USB port, user can enable or disable all I/O ports.



- **BT Pairing:** Click **Start** to pair VB342 Pro with mobile phone via Bluetooth connection. To disconnect Bluetooth connection, please cut it off from mobile phone or use remote control.

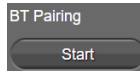

- **Trouble Shooting:** Click **Start** and **Output** to output log to save in local PC.

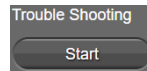

- **Test Speakerphone:** Click **Start** and **Start** to check the speakerphone status. It will require user to record a short message and play it back to ensure the speakerphone is working.

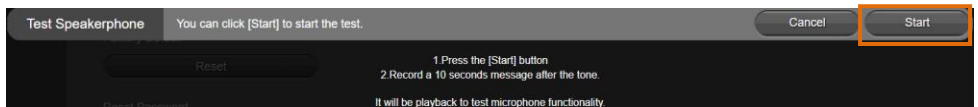
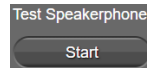

- PTZApp 2 Quit & Restore:** To quit the application, right-click the icon on the system tray and select **Quit**. If you can't launch PTZApp 2 right after installation, please right-click the icon and choose **Restore**.

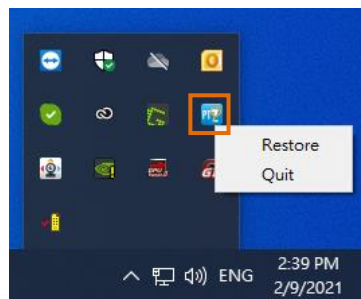

Smart Gallery Operation

You can use the Smart Gallery function to increase the visibility of each participant in the meeting room. When operating Smart Gallery function, please don't open camera view in any other applications.

[Notes]

While installing PTZApp 2, if you refuse to install Smart Gallery plug-in in your PC (illustrated as below), you will not be able to use the function. To enable the function, please reinstall PTZApp 2 for the necessary plug-in.

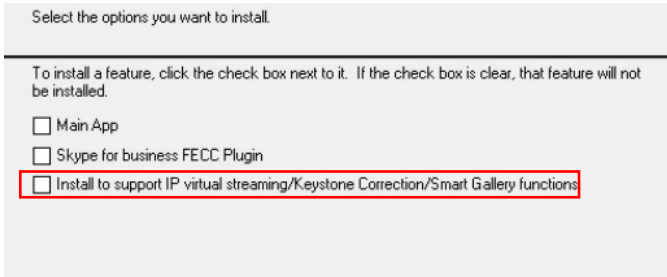

(Windows PC)

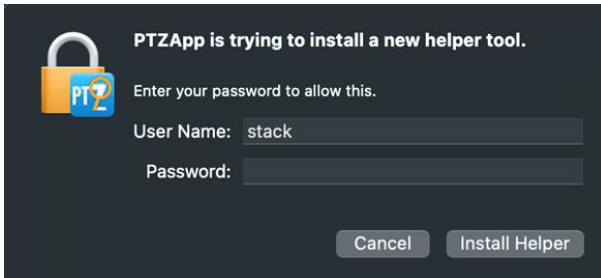

(MAC PC)

1. Connect your camera(s) supported with Smart Gallery function to the computer with USB cable.
2. Launch PTZApp 2 () and click "Smart Gallery". PTZApp 2 will start searching for the camera(s). The searched cameras supported with Smart Gallery function will be displayed.

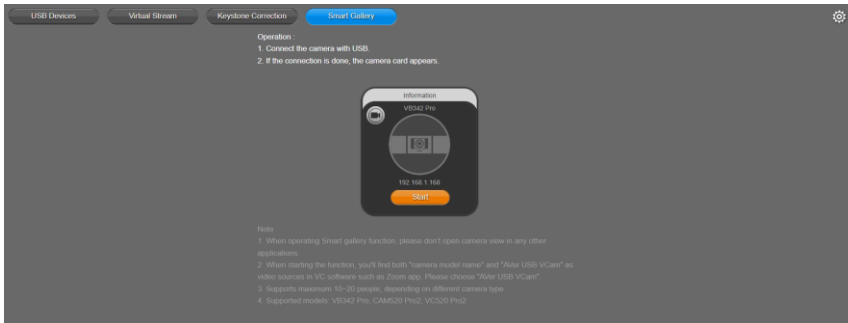

3. Click the “Start” button, the button will change to “Stop”, and you can start operating the Smart Gallery function. To stop the Smart Gallery function, click “Stop”.

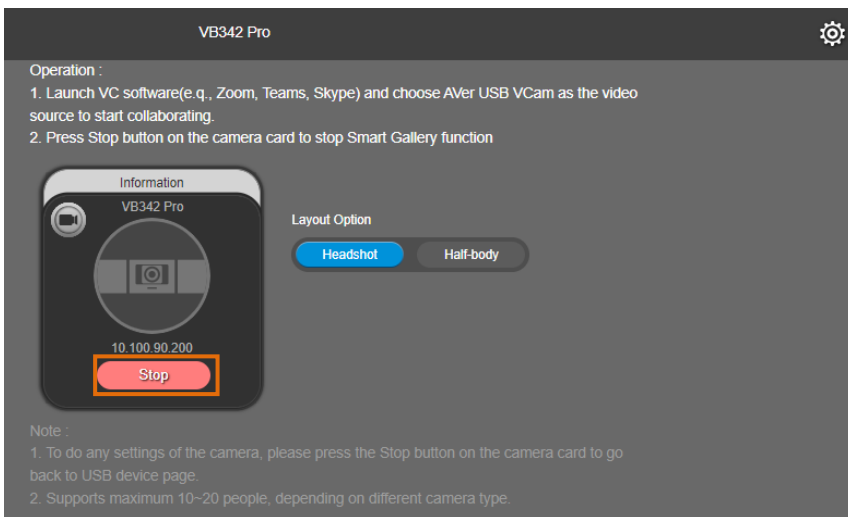

4. Launch VC software (e.g., Zoom, Teams, Skype) and choose AVer USB VCam as the video source to start collaborating. **[Note]** You will find both “camera model name” and “Aver USB VCam” as video sources in the VC software. Please choose “Aver USB VCam”.
5. In the “Layout Option” field, click “Headshot” or “Half-body” to perform the function.

Headshot Mode



Half-body Mode



6. To stop the Smart Gallery function, click the “Stop” button.

[Notes]

- Make sure each person has certain distance to have better image cropping.
- Manual Zoom in will affect the detection effect of Smart Gallery.
- To do any settings of the camera, click the “Stop” button to stop the Smart Gallery function and then go to the USB Devices page. Click “Setting” to configure camera settings.
- The Smart Gallery function supports up to 10-20 people, depending on different camera type.

EZLive

Please go to <https://www.aver.com/download-center> to download the AVer EZLive software. After downloading, double-click on the file and follow the on-screen instructions to complete the installation.

Use AVer EZLive

During a video call, EZLive can help user to do:

- (1) Camera ePTZ
- (2) Volume control for the speaker connected
- (3) Capture camera's still images
- (4) Record video
- (5) Live stream to YouTube, Livehouse.in, USTREAM, etc.
- (6) Camera Zoom in/out
- (7) Capture PC screen shot
- (8) Record PC screen video
- (9) Set up livestream
- (10) Open file management to retrieve photos and video files
- (11) Livestream setting
- (12) Drawing tool.

