

# Quick Start

Thank you for purchasing the MSI® **MEG Z690 UNIFY** motherboard. This Quick Start section provides demonstration diagrams about how to install your computer. Some of the installations also provide video demonstrations. Please link to the URL to watch it with the web browser on your phone or tablet. You may have even link to the URL by scanning the QR code.

## Preparing Tools and Components

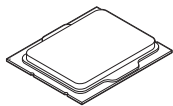

Intel® LGA1700 CPU

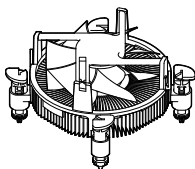

LGA1700 CPU Fan

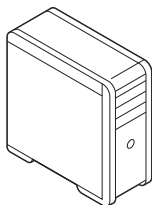

Chassis

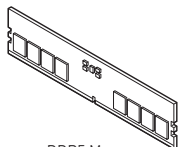

DDR5 Memory

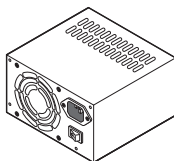

Power Supply Unit

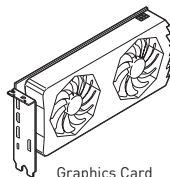

Graphics Card



Thermal Paste

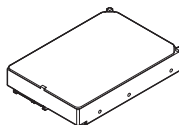

SATA Hard Disk Drive

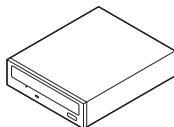

SATA DVD Drive

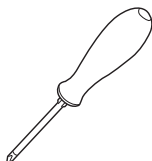

Phillips Screwdriver

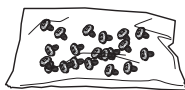

A Package of Screws

## Safety Information

- The components included in this package are prone to damage from electrostatic discharge (ESD). Please adhere to the following instructions to ensure successful computer assembly.
- Ensure that all components are securely connected. Loose connections may cause the computer to not recognize a component or fail to start.
- Hold the motherboard by the edges to avoid touching sensitive components.
- It is recommended to wear an electrostatic discharge (ESD) wrist strap when handling the motherboard to prevent electrostatic damage. If an ESD wrist strap is not available, discharge yourself of static electricity by touching another metal object before handling the motherboard.
- Store the motherboard in an electrostatic shielding container or on an anti-static pad whenever the motherboard is not installed.
- Before turning on the computer, ensure that there are no loose screws or metal components on the motherboard or anywhere within the computer case.
- Do not boot the computer before installation is completed. This could cause permanent damage to the components as well as injury to the user.
- If you need help during any installation step, please consult a certified computer technician.
- Always turn off the power supply and unplug the power cord from the power outlet before installing or removing any computer component.
- Keep this user guide for future reference.
- Keep this motherboard away from humidity.
- Make sure that your electrical outlet provides the same voltage as is indicated on the PSU, before connecting the PSU to the electrical outlet.
- Place the power cord such a way that people can not step on it. Do not place anything over the power cord.
- All cautions and warnings on the motherboard should be noted.
- If any of the following situations arises, get the motherboard checked by service personnel:
  - Liquid has penetrated into the computer.
  - The motherboard has been exposed to moisture.
  - The motherboard does not work well or you can not get it work according to user guide.
  - The motherboard has been dropped and damaged.
  - The motherboard has obvious sign of breakage.
- Do not leave this motherboard in an environment above 60°C [140°F], it may damage the motherboard.

## Installing a Processor



<https://youtu.be/KM19oIDsGes>

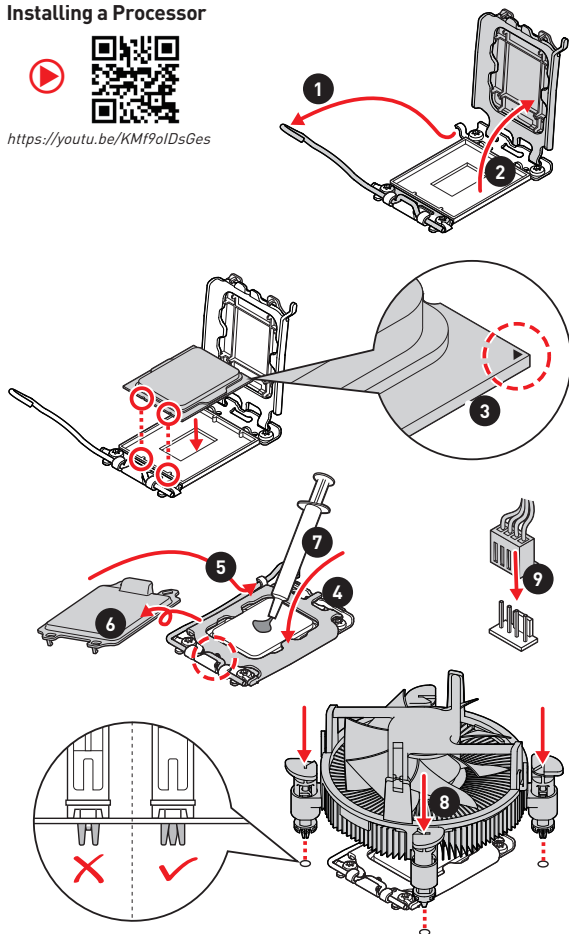

## Installing DDR5 memory



<https://youtu.be/XiNmKDNZcZk>

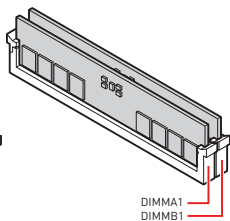
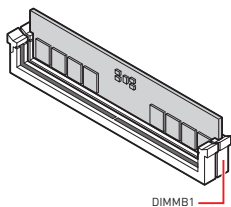
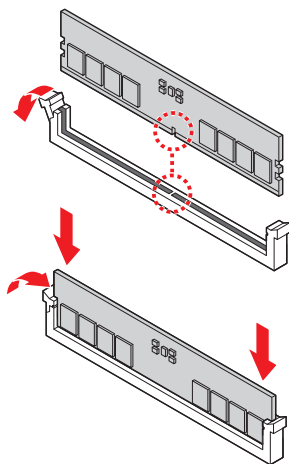

## Connecting the Front Panel Header



<http://youtu.be/DPELdVNZUI>

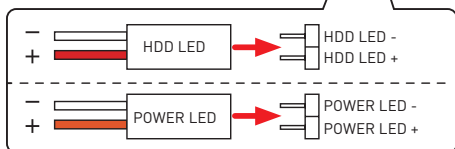
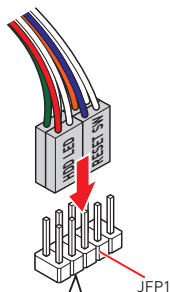
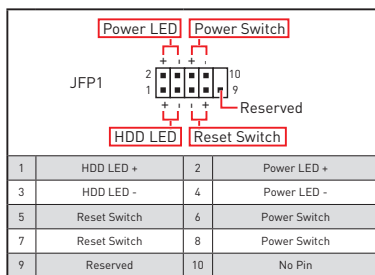
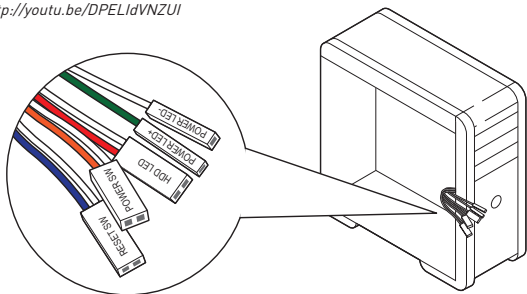

## Installing the Motherboard

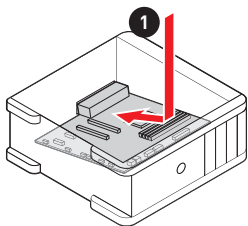
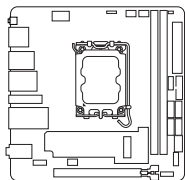

<https://youtu.be/wWl6Qt51Wnc>

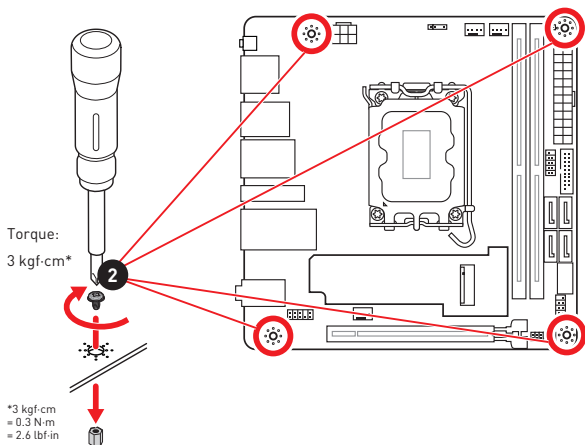

## Connecting the Power Connectors



[http://youtu.be/gkDYyR\\_8314](http://youtu.be/gkDYyR_8314)

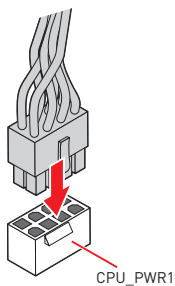
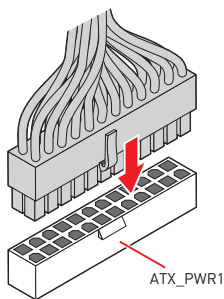
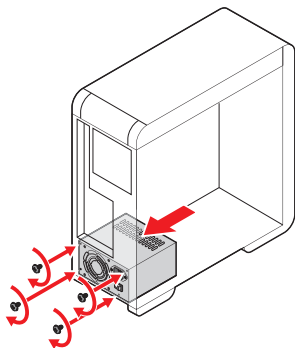

## Installing SATA Drives



<http://youtu.be/RZsMpqxythc>

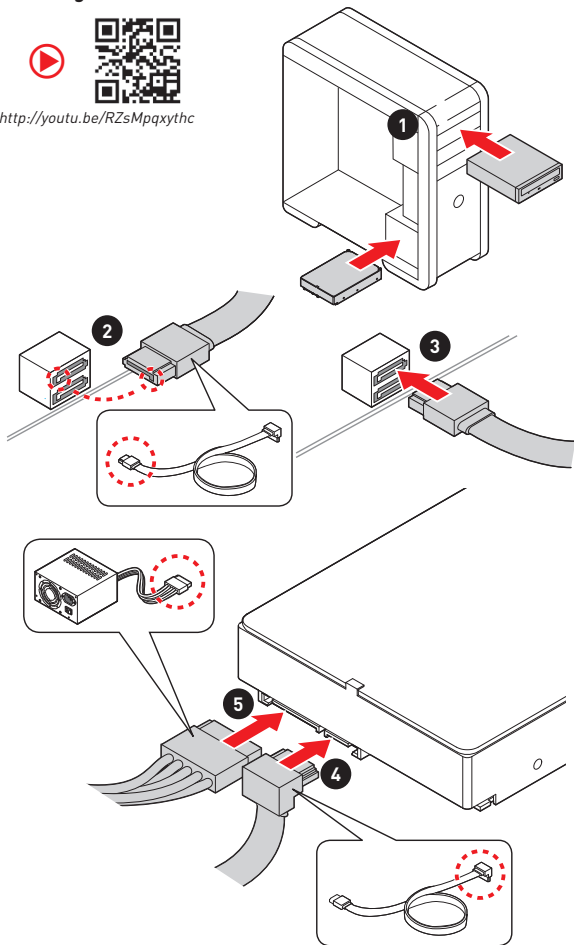



## Installing a Graphics Card



[http://youtu.be/mG0GZpr9w\\_A](http://youtu.be/mG0GZpr9w_A)

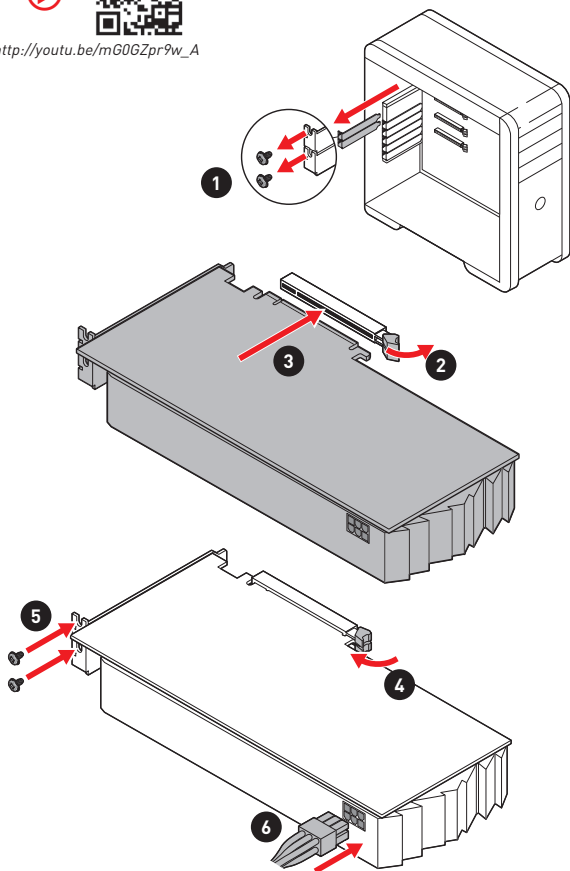

## Connecting Peripheral Devices

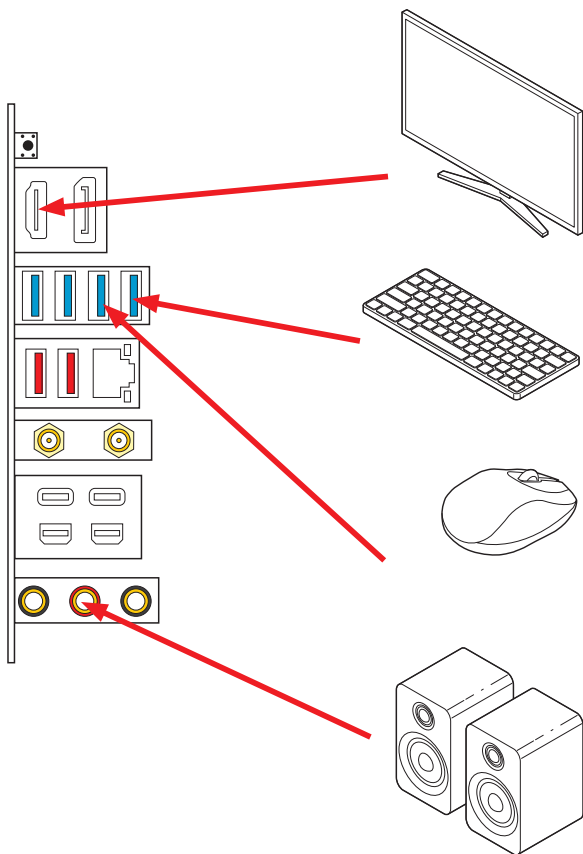

## Power On

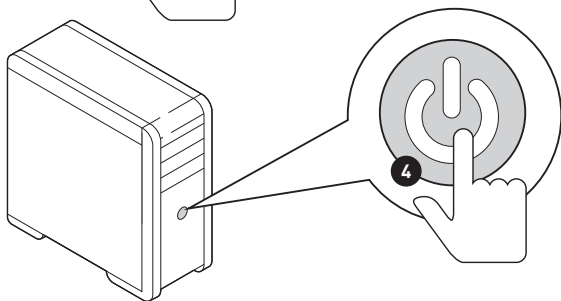
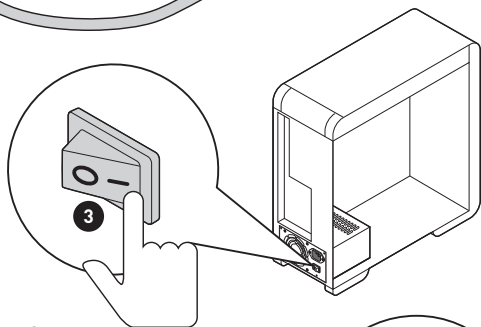
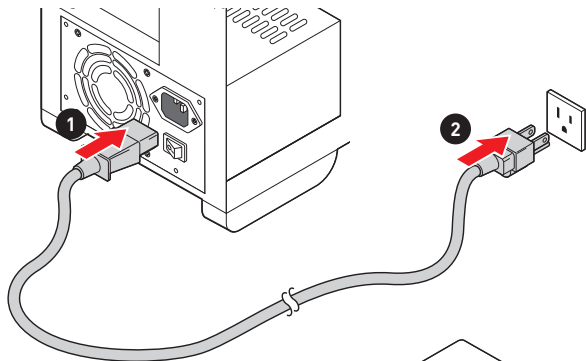

# Contents

<b>Quick Start .....</b>	<b>1</b>
Preparing Tools and Components.....	1
Safety Information .....	2
Installing a Processor .....	3
Installing DDR5 memory .....	4
Connecting the Front Panel Header .....	5
Installing the Motherboard.....	6
Connecting the Power Connectors .....	7
Installing SATA Drives.....	8
Installing a Graphics Card.....	9
Connecting Peripheral Devices.....	10
Power On .....	11
<b>Specifications.....</b>	<b>14</b>
<b>Package contents .....</b>	<b>21</b>
<b>Block Diagram .....</b>	<b>22</b>
<b>Rear I/O Panel .....</b>	<b>23</b>
LAN Port LED Status Table .....	23
Installing Antennas.....	24
Connecting Thunderbolt Devices via Daisy-chain.....	25
<b>Overview of Components .....</b>	<b>26</b>
CPU Socket .....	29
DIMM Slots.....	30
PCI_E1: PCIe Expansion Slot.....	31
SATA5~8: SATA 6Gb/s Connectors.....	31
M2_1~3: M.2 Slots (Key M) .....	32
JAUD1: Front Audio Connector .....	35
JFP1: Front Panel Connector.....	35
CPU_PWR1, ATX_PWR1: Power Connectors.....	36
JUSB3: USB 3.2 Gen 2x2 Type-C Connector .....	37
JUSB2: USB 3.2 Gen 1 Connector .....	37
JUSB1: USB 2.0 Connector .....	38
JTPM1: TPM Module Connector.....	38
CPU_FAN1, PUMP_FAN1, SYS_FAN1: Fan Connectors.....	39
JRAINBOW1: Addressable RGB LED connector.....	40
JCI1: Chassis Intrusion Connector.....	41
<b>Onboard LEDs .....</b>	<b>41</b>
EZ Debug LED .....	41

<b>Installing OS, Drivers &amp; MSI Center .....</b>	<b>42</b>
Installing Windows 10/ Windows 11 .....	42
Installing Drivers .....	42
MSI Center .....	42
<b>Nahimic 3 .....</b>	<b>43</b>
Installation and Update .....	43
Audio Tab .....	43
Microphone Tab .....	44
Sound Tracker Tab .....	45
Settings Tab .....	45
<b>UEFI BIOS .....</b>	<b>46</b>
BIOS Setup .....	47
Entering BIOS Setup .....	47
BIOS User Guide .....	47
Resetting BIOS .....	48
Updating BIOS .....	48
<b>RAID Configuration .....</b>	<b>50</b>
<b>Intel® Optane™ Memory Configuration .....</b>	<b>51</b>
<b>Troubleshooting .....</b>	<b>52</b>

# Specifications

CPU	<ul style="list-style-type: none"> <li>• Supports 12th Gen Intel® Core™ Processors, Pentium® Gold and Celeron® Processors</li> <li>• Processor socket LGA1700</li> </ul> <p>* Please go to <a href="http://www.msi.com">www.msi.com</a> to get the newest support status as new processors are released.</p>
Chipset	Intel® Z690 Chipset
Memory	<ul style="list-style-type: none"> <li>• 2x DDR5 memory slots, supporting up to 64GB*</li> <li>• Supports 1R 4800 MHz (by JEDEC &amp; POR)</li> <li>• Max. overclocking frequency:             <ul style="list-style-type: none"> <li>▪ 1DPC 1R Max speed up to 6800+ MHz</li> <li>▪ 1DPC 2R Max speed up to 5600+ MHz</li> </ul> </li> <li>• Supports Intel® XMP 3.0 OC</li> <li>• Supports Dual Controller Dual-Channel mode</li> <li>• Supports non-ECC, un-buffered memory</li> </ul> <p>* Please refer to <a href="http://www.msi.com">www.msi.com</a> for more information on compatible memory.</p>
Expansion Slot	1x PCIe 5.0 x16 slot (From CPU)
Onboard Graphics	<ul style="list-style-type: none"> <li>• 1x DisplayPort 1.4 port, supporting a maximum resolution of 4K 60Hz*/**</li> <li>• 1x HDMI 2.1 with HDR port, supporting a maximum resolution of 4K 60Hz*/**</li> </ul> <p>* Available only on processors featuring integrated graphics. ** Graphics specifications may vary depending on the CPU installed.</p>
Thunderbolt 4	<p>Intel® JHL8540 Thunderbolt™ 4 Controller</p> <ul style="list-style-type: none"> <li>• 2x Thunderbolt™ 4 (USB-C) ports on the back panel             <ul style="list-style-type: none"> <li>▪ Supports up to 40Gbps transfer rate with Thunderbolt devices</li> <li>▪ Supports up to 20Gbps transfer rate with USB4 devices</li> <li>▪ Supports up to 10Gbps transfer rate with USB 3.2 devices</li> <li>▪ Supports up to 5V/3A ,15W power charging</li> <li>▪ Each port can daisy-chain up to three Thunderbolt 4 devices or five Thunderbolt 3 devices</li> <li>▪ Supports up to 8K display (need to connect the DisplayPort of the motherboard or discrete graphics card to the Mini DisplayPort Input port on the back panel)</li> </ul> </li> </ul>

Continued on next column

Continued from previous column

<b>Storage</b>	<ul style="list-style-type: none"><li>• 4x SATA 6Gb/s ports (From Z690 chipset)</li><li>• 3x M.2 slots (Key M)<ul style="list-style-type: none"><li>▪ M2_1 slot (From CPU)<ul style="list-style-type: none"><li>▫ Supports up to PCIe 4.0 x4</li><li>▫ Supports 2280 storage devices</li></ul></li><li>▪ M2_2 slot (From Z690 chipset)<ul style="list-style-type: none"><li>▫ M2_2 supports up to PCIe 3.0 x4</li><li>▫ Supports up to SATA 6Gb/s</li><li>▫ Supports 2280 storage devices</li></ul></li><li>▪ M2_3 slot (From Z690 chipset)<ul style="list-style-type: none"><li>▫ M2_3 supports up to PCIe 4.0 x4</li><li>▫ Supports 2280 storage devices</li></ul></li><li>▪ M2_2-3 slots support Intel® Optane™ Memory</li></ul></li><li>• Supports Intel® Smart Response Technology for Intel Core™ processors</li></ul>
<b>RAID</b>	<ul style="list-style-type: none"><li>• Supports RAID 0, RAID 1, RAID 5 and RAID 10 for SATA storage devices</li><li>• Supports RAID 0, RAID 1 and RAID 5 for M.2 NVMe storage devices</li></ul>
<b>USB</b>	<ul style="list-style-type: none"><li>• Intel® Z690 Chipset<ul style="list-style-type: none"><li>▪ 1x USB3.2 Gen2x2 20Gbps port (1 Type-C internal connector)</li><li>▪ 2x USB 3.2 Gen 2 10Gbps ports on the back panel</li><li>▪ 6x USB 3.2 Gen 1 5Gbps ports (4 Type-A ports on the back panel and 2 ports available through internal USB connectors)</li><li>▪ 2x USB 2.0 ports available through the internal USB connector</li></ul></li></ul>
<b>Audio</b>	Realtek® ALC4080 Codec <ul style="list-style-type: none"><li>• 7.1-Channel High Definition Audio</li></ul>
<b>LAN</b>	<ul style="list-style-type: none"><li>• 1x Intel® I225V 2.5Gbps LAN controller</li></ul>

Continued on next column

Continued from previous column

<b>Wireless LAN &amp; Bluetooth®</b>	<p>Intel® Wi-Fi 6E</p> <ul style="list-style-type: none"><li>• The Wireless module is pre-installed in the M.2 (Key-E) slot</li><li>• Supports MU-MIMO TX/RX, 2.4GHz/ 5GHz/ 6GHz*(160MHz) up to 2.4Gbps</li><li>• Supports 802.11 a/ b/ g/ n/ ac/ ax</li><li>• Supports Bluetooth® 5.2**, FIPS, FISMA</li></ul> <p>* Wi-Fi 6E 6GHz may depend on every country's regulations and will be ready in Windows 10 build 21H1 and Windows 11. ** Bluetooth 5.2 will be ready in Windows 10 build 21H1 and Windows 11.</p>
<b>Internal Connectors</b>	<ul style="list-style-type: none"><li>• 1x 24-pin ATX main power connector</li><li>• 1x 8-pin ATX 12V power connector</li><li>• 4x SATA 6Gb/s connectors</li><li>• 3x M.2 slots (M-Key)</li><li>• 1x USB 3.2 Gen 2x2 20Gbps Type-C connector</li><li>• 1x USB 3.2 Gen 1 5Gbps connector (supports additional 2 USB 3.2 Gen 1 5Gbps ports)</li><li>• 1x USB 2.0 connector (supports additional 2 USB 2.0 ports)</li><li>• 1x 4-pin CPU fan connector</li><li>• 1x 4-pin water-pump fan connector</li><li>• 1x 4-pin system fan connector</li><li>• 1x Front panel audio connector</li><li>• 1x System panel connector</li><li>• 1x Chassis Intrusion connector</li><li>• 1x TPM module connector</li></ul>
<b>LED Features</b>	<ul style="list-style-type: none"><li>• 4x EZ Debug LED</li><li>• 1x 3-pin RAINBOW LED connector</li></ul>

Continued on next column



Continued from previous column

<b>Back Panel Connectors</b>	<ul style="list-style-type: none"><li>• 1x Clear CMOS button</li><li>• 1x DisplayPort port</li><li>• 1x HDMI port</li><li>• 4x USB 3.2 Gen 1 5Gbps Type-A ports</li><li>• 2x USB 3.2 Gen 2 10Gbps Type-A ports</li><li>• 1x LAN (RJ45) port</li><li>• 2x Thunderbolt 4 (USB-C) ports</li><li>• 2x Mini DisplayPort Input (for Thunderbolt 4 passthrough)</li><li>• 2x Wi-Fi Antenna connectors</li><li>• 3x OFC audio jacks</li></ul>
<b>I/O Controller</b>	NUVOTON NCT6687-R Controller Chip
<b>Hardware Monitor</b>	<ul style="list-style-type: none"><li>• CPU/ System/ Chipset temperature detection</li><li>• CPU/ System/ Pump fan speed detection</li><li>• CPU/ System/ Pump fan speed control</li></ul>
<b>Form Factor</b>	<ul style="list-style-type: none"><li>• Mini-ITX Form Factor</li><li>• 6.7 in. x 6.7 in. (17.0 cm x 17.0 cm)</li></ul>
<b>BIOS Features</b>	<ul style="list-style-type: none"><li>• 1x 256 Mb flash</li><li>• UEFI AMI BIOS</li><li>• ACPI 6.4, SMBIOS 3.4</li><li>• Multi-language</li></ul>
<b>Software</b>	<ul style="list-style-type: none"><li>• Drivers</li><li>• MSI Center</li><li>• Intel Extreme Tuning Utility</li><li>• Nahimic Audio</li><li>• MSI APP Player (BlueStacks)</li><li>• Open Broadcaster Software (OBS)</li><li>• CPU-Z MSI GAMING</li><li>• Google Chrome™, Google Toolbar, Google Drive</li><li>• Norton™ Internet Security Solution</li></ul>

Continued on next column

Continued from previous column

<b>MSI Center Features</b>	<ul style="list-style-type: none"><li>• MSI Sound Tune</li><li>• Gaming Mode</li><li>• Smart Priority</li><li>• Game Highlights</li><li>• LAN Manager</li><li>• Mystic Light</li><li>• Ambient Devices</li><li>• Frozr AI Cooling</li><li>• User Scenario</li><li>• True Color</li><li>• Live Update</li><li>• Hardware Monitoring</li><li>• Super Charger</li><li>• Speed Up</li><li>• Smart Image Finder</li><li>• MSI Companion</li></ul>
<b>Special Features</b>	<ul style="list-style-type: none"><li>• Audio<ul style="list-style-type: none"><li>▪ Audio Boost 5</li><li>▪ Nahimic 3</li><li>▪ Sound Tune</li></ul></li><li>• Network<ul style="list-style-type: none"><li>▪ 2.5G LAN</li><li>▪ LAN Manager</li><li>▪ Intel Wi-Fi</li></ul></li></ul>

Continued on next column

Continued from previous column

## Special Features

- Cooling
  - All Aluminum Design
  - Heat-pipe Design
  - Extended Heatsink Design
  - Aluminum Backplate
  - M.2 Shield Frozr
  - 7W/mK MOSFET thermal pad
  - Choke thermal pad
  - Pump Fan
  - Smart Fan Control
- LED
  - Mystic Light Extension (RAINBOW)
  - Mystic Light SYNC
  - Ambient Devices Support
- Performance
  - Lightning Gen 5 (PCI-E)
  - Lightning Gen 4 (M.2)
  - Memory Boost
  - Memory Force
  - Core Boost
  - Game Boost
  - OC Engine
  - Thunderbolt 4/ USB 4.0
  - Lightning USB 20G
  - USB 3.2 Gen 2 10G
  - USB with Type A+C
  - Front USB Type-C
  - Server PCB

Continued on next column

Continued from previous column

### Special Features

- Protection
  - PCI-E Steel Armor
  - Pre-installed I/O Shield
- Experience
  - MSI Center
  - Click BIOS 5
  - Frozr AI Cooling
  - EZ LED Control
  - EZ DEBUG LED
  - App player
  - Tile

# Package contents

Please check the contents of your motherboard package. It should contain:

<b>Motherboard</b>	MEG Z690I UNIFY	
<b>Documentation</b>	User manual	1
	Quick guide	1
	Quick installation guide	1
<b>Application</b>	USB drive with drivers & utilities	1
<b>Cables</b>	SATA 6Gb/s cable	1
	LED JRAINBOW cable	1
	DP to Mini-DP cable	1
	Front Panel Cable	1
<b>Accessories</b>	Wi-Fi antenna	1
	Case badge	1
	M.2 screw (3 pieces/pack)	1
	MEG sticker	1
	SATA cable sticker	1
	Product registration card	1
<b>Gifts</b>	Small screwdriver set	1
	Small brush	1



## **Important**

*If any of the above items are damaged or missing, please contact your retailer.*

# Block Diagram

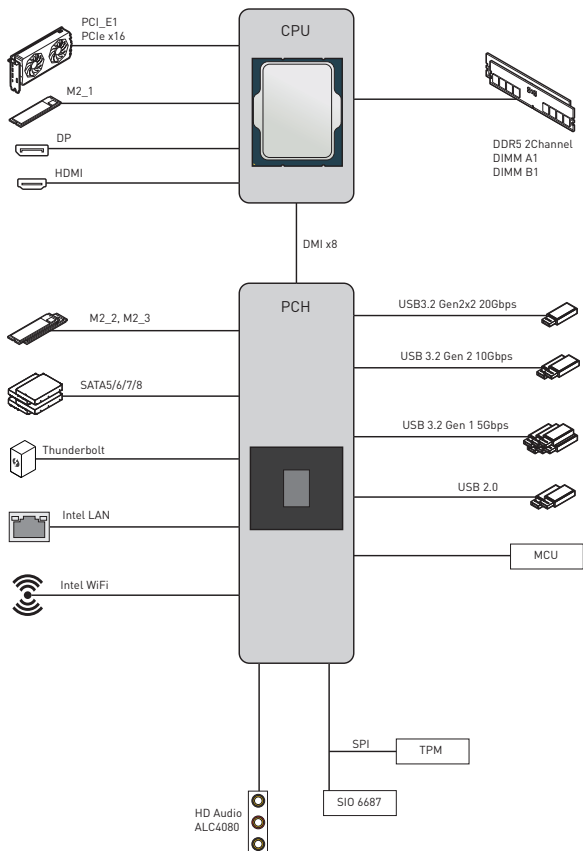

 **Important**

*The icons above are for reference only.*

## Rear I/O Panel

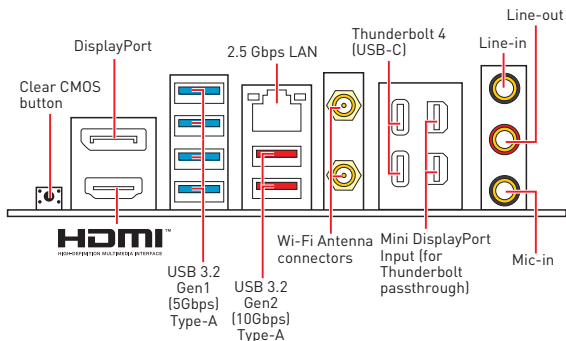

- **Clear CMOS button** - Power off your computer. Press and hold the Clear CMOS button for about 5-10 seconds to reset BIOS to default values.

### LAN Port LED Status Table

Link/ Activity LED			Speed LED	
Status	Description		Status	Description
Off	No link	Off	10 Mbps connection	
Yellow	Linked	Green	100/1000 Mbps connection	
Blinking	Data activity	Orange	2.5 Gbps connection	

### Audio 7.1-channel Configuration

To configure 7.1-channel audio, you have to connect front audio I/O module to JAUD1 connector and follow the below steps.

1. Click on the **Realtek Audio Console > Advanced Settings** to open the dialog below.

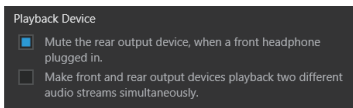

2. Select **Mute the rear output device, when a front headphone plugged in**.
3. Plug your speakers to audio jacks on rear and front I/O panel. When you plug into a device at an audio jack, a dialogue window will pop up asking you which device is current connected.

## Installing Antennas

1. Combine the antenna with the base.
2. Screw two antenna cables tight to the WiFi antenna connectors as shown.

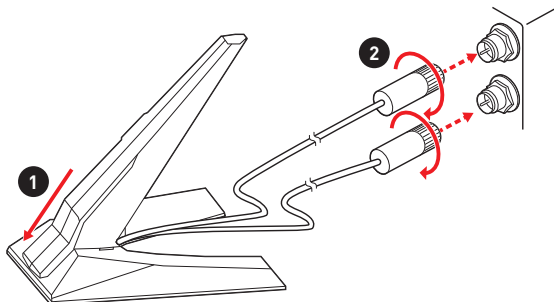

3. Place the antenna as high as possible.

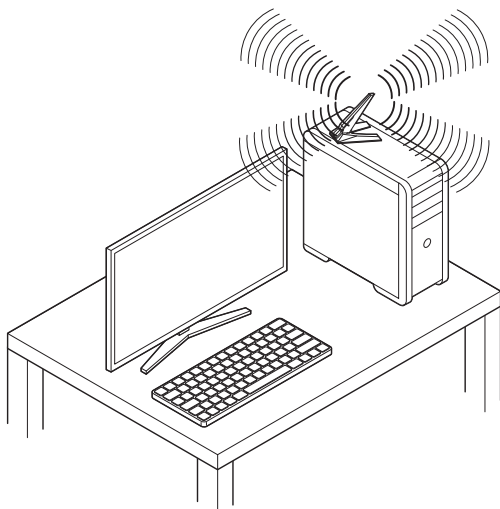



## Connecting Thunderbolt Devices via Daisy-chain

Daisy-chain is a method of connecting multiple devices to a PC with only one output terminal.

Daisy-chain allows you to connect multiple thunderbolt devices to a single thunderbolt port on the back panel.

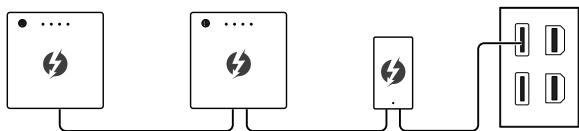

You can also daisy chain monitor by connecting graphics card to the Mini DisplayPort Input port on the back panel.

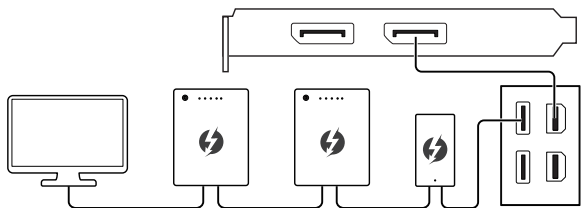

If you want to connect USB devices, please place them at the end of the chain.

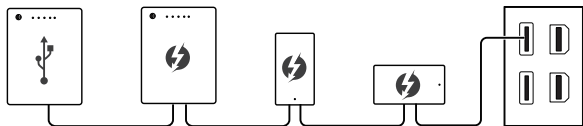

# Overview of Components

## Front view

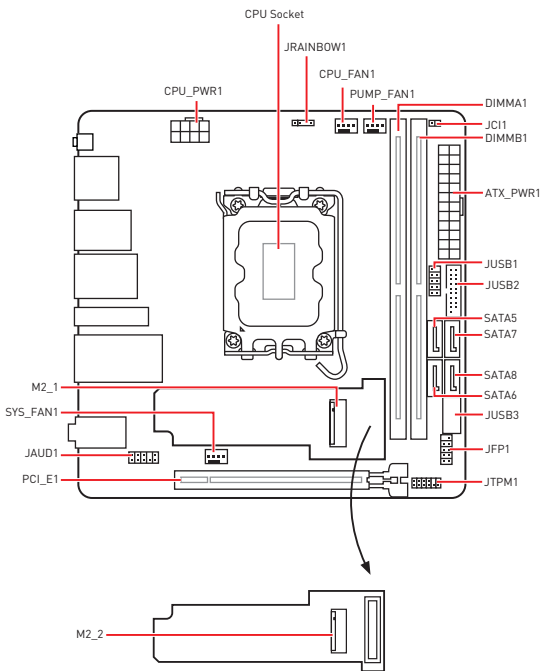

## Bottom view

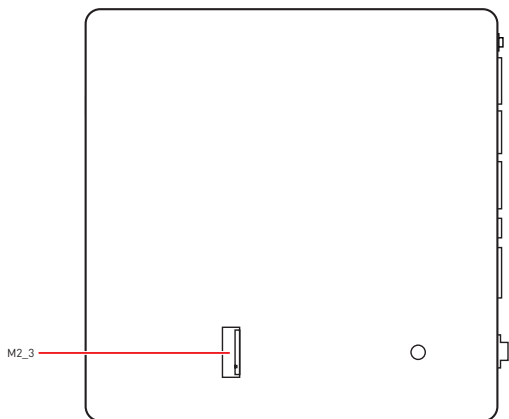

## Component Contents

Port Name	Port Type	Page
CPU_FAN1, PUMP_FAN1, SYS_FAN1	Fan Connectors	39
CPU_PWR1, ATX_PWR1	Power Connectors	36
CPU Socket	LGA1700 CPU Socket	29
DIMM Slots	Memory slots	30
JAUD1	Front Audio Connector	35
JCI1	Chassis Intrusion Connector	41
JFP1	Front Panel Connector	35
JRAINBOW1	Addressable RGB LED connector	40
JTPM1	TPM Module Connector	38
JUSB1	USB 2.0 Connector	38
JUSB2	USB 3.2 Gen 1 Connector	37
JUSB3	USB 3.2 Gen 2x2 Type-C Connector	37
M2_1~3	M.2 Slots (Key M)	32
PCI_E1	PCIe Expansion Slot	31
SATA5~8	SATA 6Gb/s Connectors	31

## CPU Socket

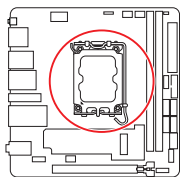

Distance from the center of the CPU to the nearest DIMM slot.

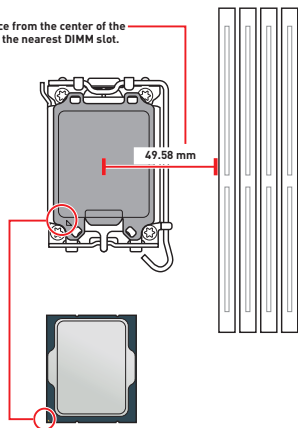

### Introduction to the LGA1700 CPU

The surface of the LGA1700 CPU has four **notches** and a **golden triangle** to assist in correctly lining up the CPU for motherboard placement. The golden triangle is the Pin 1 indicator.

#### Important

- Always unplug the power cord from the power outlet before installing or removing the CPU.
- Please retain the CPU protective cap after installing the processor. MSI will deal with Return Merchandise Authorization (RMA) requests if only the motherboard comes with the protective cap on the CPU socket.
- When installing a CPU, always remember to install a CPU heatsink. A CPU heatsink is necessary to prevent overheating and maintain system stability.
- Confirm that the CPU heatsink has formed a tight seal with the CPU before booting your system.
- Overheating can seriously damage the CPU and motherboard. Always make sure the cooling fans work properly to protect the CPU from overheating. Be sure to apply an even layer of thermal paste (or thermal tape) between the CPU and the heatsink to enhance heat dissipation.
- Whenever the CPU is not installed, always protect the CPU socket pins by covering the socket with the plastic cap.
- If you purchased a separate CPU and heatsink/ cooler, Please refer to the documentation in the heatsink/ cooler package for more details about installation.
- This motherboard is designed to support overclocking. Before attempting to overclock, please make sure that all other system components can tolerate overclocking. Any attempt to operate beyond product specifications is not recommended. MSI® does not guarantee the damages or risks caused by inadequate operation beyond product specifications.

## DIMM Slots

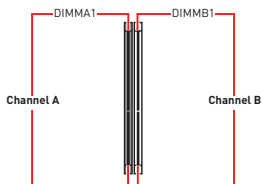
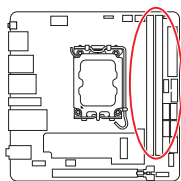

## Memory module installation recommendation

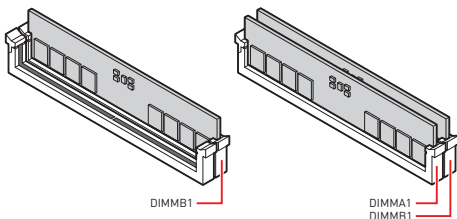

### Important

- Always insert memory modules in the **DIMMB1** slot first.
- To ensure system stability for Dual channel mode, memory modules must be of the same type, number and density.
- Some memory modules may operate at a lower frequency than the marked value when overclocking due to the memory frequency operates dependent on its Serial Presence Detect (SPD). Go to BIOS and find the **DRAM Frequency** to set the memory frequency if you want to operate the memory at the marked or at a higher frequency.
- It is recommended to use a more efficient memory cooling system for full DIMMs installation or overclocking.
- The stability and compatibility of installed memory module depend on installed CPU and devices when overclocking.
- Please refer to [www.msi.com](http://www.msi.com) for more information on compatible memory.

## PCI\_E1: PCIe Expansion Slot

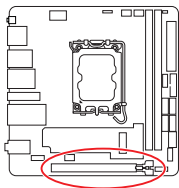

### Important

- If you install a large and heavy graphics card, you need to use a tool such as **MSI Graphics Card Bolster** to support its weight to prevent deformation of the slot.
- When adding or removing expansion cards, always turn off the power supply and unplug the power supply power cable from the power outlet. Read the expansion card's documentation to check for any necessary additional hardware or software changes.

## SATA5~8: SATA 6Gb/s Connectors

These connectors are SATA 6Gb/s interface ports. Each connector can connect to one SATA device.

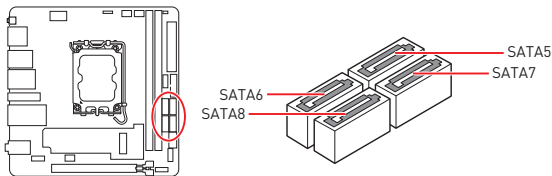

### Important

- Please do not fold the SATA cable at a 90-degree angle. Data loss may result during transmission otherwise.
- SATA cables have identical plugs on either sides of the cable. However, it is recommended that the flat connector be connected to the motherboard for space saving purposes.

## M2\_1~3: M.2 Slots (Key M)

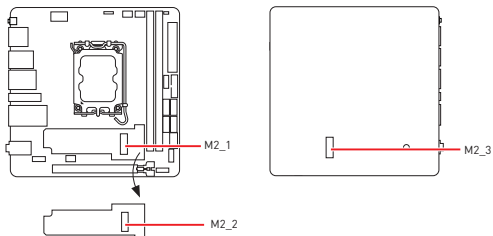

### Important

- Intel® RST only supports PCIe M.2 SSD with UEFI ROM.
- M2\_2~3 slots support Intel® Optane™ Memory.

### Installing M.2 module

For M2\_1 & M2\_3 slots:

1. Loosen the screws of M.2 SHIELD FROZR heatsink.
2. Remove the M.2 SHIELD FROZR and remove the protective films from the thermal pad.

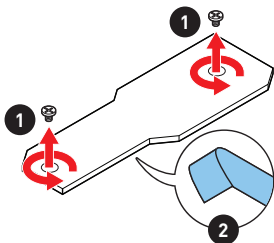

3. Insert your M.2 SSD into the M2\_1 slot at a 30-degree angle.
4. Secure the M.2 SSD in place with the supplied M.2 8.5H screw.

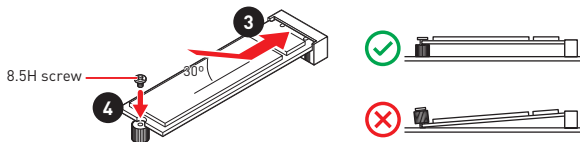



- Put the M.2 SHIELD FROZR heatsink back in place and secure it.

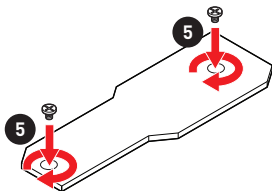

**!** **Important**

Please follow the step 3 and step 4 above to install the M.2 SSD into the **M2\_3** slot.

**For M2\_2 slot:**

- Loosen the screws of M.2 SHIELD FROZR heatsink and remove the heatsink.
- Loosen the screws of M.2 adapter card.
- Pull out the M.2 adapter card.

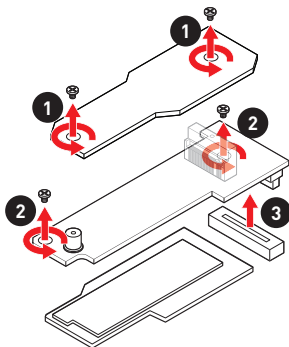

4. Turn the M.2 adapter card over and place the M2\_2 slot up.
5. Insert your M.2 SSD into the M2\_2 slot at a 30-degree angle.
6. Secure the M.2 SSD in place with the supplied M.2 8.5H screw.

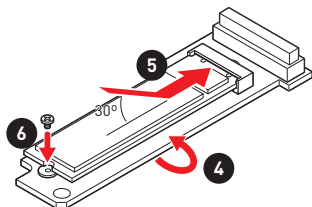

7. Remove the protective films from the thermal pad on the bottom heatsink.
8. Turn back the M.2 adapter card and place the M2\_1 slot up.
9. Plug the M.2 adapter card into M2\_SWITCH1 slot.
10. Secure the M.2 adapter card.
11. Put the M.2 SHIELD FROZR heatsink back in place and secure it.

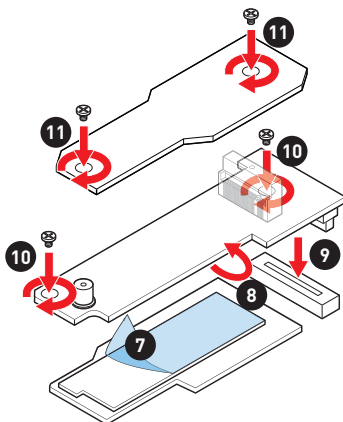

## JAUD1: Front Audio Connector

This connector allows you to connect audio jacks on the front panel.

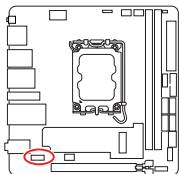

JAUD1 Pinout Diagram			
2		10	
1		9	
1	MIC L	2	Ground
3	MIC R	4	NC
5	Head Phone R	6	MIC Detection
7	SENSE_SEND	8	No Pin
9	Head Phone L	10	Head Phone Detection

## JFP1: Front Panel Connector

These connectors connect to the switches and LEDs on the front panel.

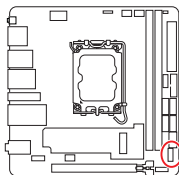

JFP1 Pinout Diagram			
10		9	
2		1	
JFP1		Reserved	
Power Switch	-	+	Reset Switch
Power LED	-	-	HDD LED
+	+	+	
1	HDD LED +	2	Power LED +
3	HDD LED -	4	Power LED -
5	Reset Switch	6	Power Switch
7	Reset Switch	8	Power Switch
9	Reserved	10	No Pin

## CPU\_PWR1, ATX\_PWR1: Power Connectors

These connectors allow you to connect an ATX power supply.

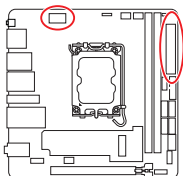

CPU_PWR1			
1	Ground	5	+12V
2	Ground	6	+12V
3	Ground	7	+12V
4	Ground	8	+12V

ATX_PWR1			
1	+3.3V	13	+3.3V
2	+3.3V	14	-12V
3	Ground	15	Ground
4	+5V	16	PS-ON#
5	Ground	17	Ground
6	+5V	18	Ground
7	Ground	19	Ground
8	PWR OK	20	Res
9	5VSB	21	+5V
10	+12V	22	+5V
11	+12V	23	+5V
12	+3.3V	24	Ground

### **Important**

Make sure that all the power cables are securely connected to a proper ATX power supply to ensure stable operation of the motherboard.

## JUSB3: USB 3.2 Gen 2x2 Type-C Connector

This connector allows you to connect USB 3.2 Gen 2x2 20Gbps Type-C connector on the front panel. The connector possesses a foolproof design. When you connect the cable, be sure to connect it with the corresponding orientation.

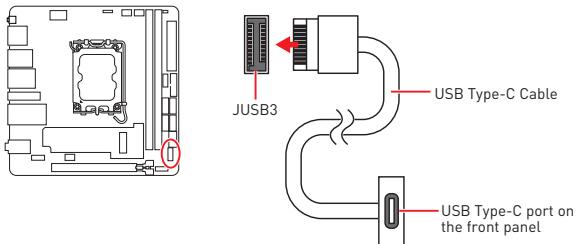

## JUSB2: USB 3.2 Gen 1 Connector

This connector allows you to connect USB 3.2 Gen 1 5Gbps ports on the front panel.

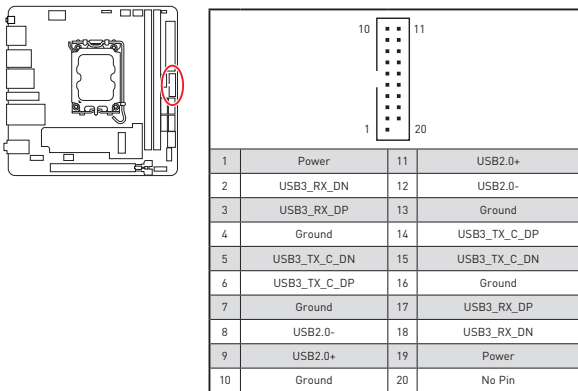



### Important

Note that the Power and Ground pins must be connected correctly to avoid possible damage.

## JUSB1: USB 2.0 Connector

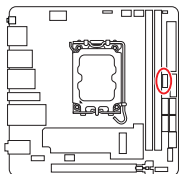
This connector allows you to connect USB 2.0 ports on the front panel.



			
1	VCC	2	VCC
3	USB0-	4	USB1-
5	USB0+	6	USB1+
7	Ground	8	Ground
9	No Pin	10	NC





### Important

- Note that the VCC and Ground pins must be connected correctly to avoid possible damage.
- In order to recharge your iPad, iPhone and iPod through USB ports, please install MSI Center utility.

## JTPM1: TPM Module Connector

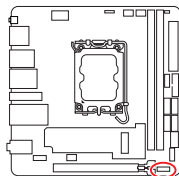
This connector is for TPM (Trusted Platform Module). Please refer to the TPM security platform manual for more details and usages.



			
1	SPI Power	2	SPI Chip Select
3	Master In Slave Out (SPI Data)	4	Master Out Slave In (SPI Data)
5	Reserved	6	SPI Clock
7	Ground	8	SPI Reset
9	Reserved	10	No Pin
11	Reserved	12	Interrupt Request

## CPU\_FAN1, PUMP\_FAN1, SYS\_FAN1: Fan Connectors

Fan connectors can be classified as PWM (Pulse Width Modulation) Mode or DC Mode. PWM Mode fan connectors provide constant 12V output and adjust fan speed with speed control signal. DC Mode fan connectors control fan speed by changing voltage. The auto mode fan connectors can automatically detect PWM and DC mode. However, you can follow the instruction below to adjust the fan connector to PWM or DC Mode manually.

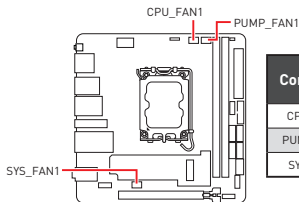

Connector	Default fan mode	Max. current	Max. power
CPU_FAN1	Auto mode	2A	24W
PUMP_FAN1	PWM mode	3A	36W
SYS_FAN1	DC mode	2A	24W

### Switching fan mode and adjusting fan speed

You can switch between PWM mode and DC mode and adjust fan speed in **BIOS > HARDWARE MONITOR**.

Select **PWM** mode or **DC** mode



There are gradient points of the fan speed that allow you to adjust fan speed in relation to CPU temperature.



### Important

Make sure fans are working properly after switching the PWM/ DC mode.

### Pin definition of fan connectors

1  PWM Mode pin definition			
1	Ground	2	+12V
3	Sense	4	Speed Control Signal

1  DC Mode pin definition			
1	Ground	2	Voltage Control
3	Sense	4	NC

## JRAINBOW1: Addressable RGB LED connector

The JRAINBOW connector allows you to connect the WS2812B Individually Addressable RGB LED strips 5V.

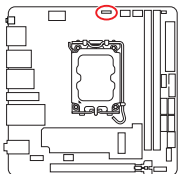

1			
1	+5V	2	Data
3	No Pin	4	Ground

### Addressable RGB LED Strip Connection

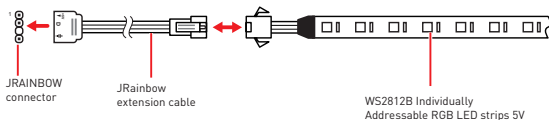

### Addressable RGB LED Fan Connection

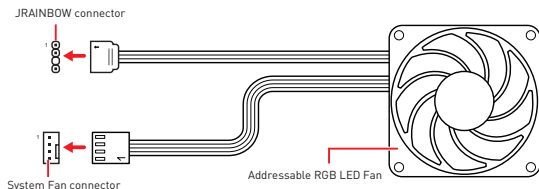

### CAUTION

Do not connect the wrong type of LED strips. The JRGB connector and the JRAINBOW connector provide different voltages, and connecting the 5V LED strip to the JRGB connector will result in damage to the LED strip.

### Important

- The JRAINBOW connector supports up to 75 LEDs WS2812B Individually Addressable RGB LED strips (5V/Data/Ground) with the maximum power rating of 3A (5V). In the case of 20% brightness, the connector supports up to 200 LEDs.
- Always turn off the power supply and unplug the power cord from the power outlet before installing or removing the RGB LED strip.
- Please use MSI's software to control the extended LED strip.



## JCI1: Chassis Intrusion Connector

This connector allows you to connect the chassis intrusion switch cable.

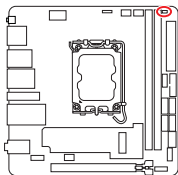

Normal  
(default)



Trigger the chassis  
intrusion event

### Using chassis intrusion detector

1. Connect the **JCI1** connector to the chassis intrusion switch/ sensor on the chassis.
2. Close the chassis cover.
3. Go to **BIOS > SETTINGS > Security > Chassis Intrusion Configuration**.
4. Set **Chassis Intrusion** to **Enabled**.
5. Press **F10** to save and exit and then press the **Enter** key to select **Yes**.
6. Once the chassis cover is opened again, a warning message will be displayed on screen when the computer is turned on.

### Resetting the chassis intrusion warning

1. Go to **BIOS > SETTINGS > Security > Chassis Intrusion Configuration**.
2. Set **Chassis Intrusion** to **Reset**.
3. Press **F10** to save and exit and then press the **Enter** key to select **Yes**.

## Onboard LEDs

### EZ Debug LED

These LEDs indicate the debug status of the motherboard.

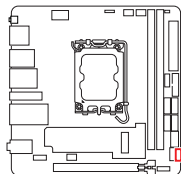

**CPU** - indicates CPU is not detected or fail.

**DRAM** - indicates DRAM is not detected or fail.

**VGA** - indicates GPU is not detected or fail.

**BOOT** - indicates the booting device is not detected or fail.

# Installing OS, Drivers & MSI Center

Please download and update the latest utilities and drivers at [www.msi.com](http://www.msi.com)

## Installing Windows 10/ Windows 11

1. Power on the computer.
2. Insert the Windows 10/ Windows 11 installation disc/USB into your computer.
3. Press the **Restart** button on the computer case.
4. Press **F11** key during the computer POST (Power-On Self Test) to get into Boot Menu.
5. Select the Windows 10/ Windows 11 installation disc/USB from the Boot Menu.
6. Press any key if screen shows **Press any key to boot from CD or DVD...** message. If not, please skip this step.
7. Follow the instructions on the screen to install Windows 10/ Windows 11.

## Installing Drivers

1. Start up your computer in Windows 10/ Windows 11.
2. Insert MSI® USB Drive into the USB port.
3. Click the **Select to choose what happens with this disc** pop-up notification, then select **Run DVDSetup.exe** to open the installer. If you turn off the AutoPlay feature from the Windows Control Panel, you can still manually execute the **DVDSetup.exe** from the root path of the MSI USB Drive.
4. The installer will find and list all necessary drivers in the **Drivers/Software** tab.
5. Click the **Install** button in the lower-right corner of the window.
6. The drivers installation will then be in progress, after it has finished it will prompt you to restart.
7. Click **OK** button to finish.
8. Restart your computer.

## MSI Center

MSI Center is an application that helps you easily optimize game settings and smoothly use content creation softwares. It also allows you to control and synchronize LED light effects on PCs and other MSI products. With MSI Center, you can customize ideal modes, monitor system performance, and adjust fan speed.

### MSI Center User Guide



If you would like to know more information about MSI Center, please refer to

<http://download.msi.com/manual/mb/MSICENTER.pdf>

or scan the QR code to access.



### **Important**

*Functions may vary depending on the product you have.*

# Nahimic 3

Nahimic 3 is designed to offer the best audio experience it contains audio effects, microphone effects and Sound Tracker.

## Installation and Update

Nahimic 3 is included in the audio driver. If you need to install it or update it, please use the **Driver Disc** with your motherboard or download the driver from MSI's official website.

## Audio Tab

From this tab, you can access all of Nahimic 3's audio effects, audio profiles and settings.

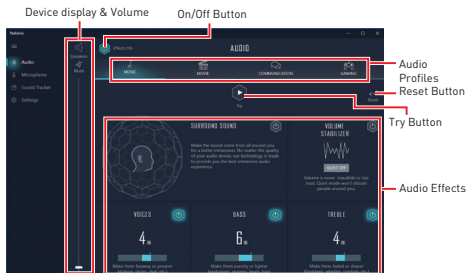

- **Device display & Volume** - displays the type of audio device currently being used as output, as well as its current volume.
  - **Mute** - mutes the current audio output device.
- **Audio profiles** - allows you to choose between 4 factory audio profiles to fit your multimedia experience (Music, Gaming, Movie or Communication). All profiles can be modified as you wish.
- **On/Off Button** - allows you to turn all of Nahimic 3's audio effects in one click.
- **Audio Effects** - allows you to separately control any of the 5 audio effects.
  - **Surround Sound** - it is an audio effect mainly dedicated to headphones acoustic experience.
    - **Gaming and Movies** - virtualizes the multichannel audio stream from the game engine or the movie soundtrack and downmixes it in order to retrieve a multichannel listening experience over your stereo headphones or speakers.
    - **Music** - expands the stereo for a wider sound stage.
  - **Volume Stabilizer** - it maintains a constant volume for all elements of the audio experience (dialogs, soundtrack, explosions, etc.) to make them all sound softer, balanced or louder. The Quiet On / Off option allows to enter a night mode by removing some basses. This way, you won't disturb people around you if you're using speakers to play your media.

- **Voices** - it boosts (or removes) the speech in movies, video games and incoming communication from -12 to +12 dB.
- **Bass** - increases (or decreases) the energy in low frequencies from -12 to +12 dB.
- **Treble** - increases (or decreases) the energy in high frequencies from -12 to +12 dB.
- **Reset Button** - restores the current profile to its default values.
- **Try Button** - launches an audio sample that allows to test audio settings.

## Microphone Tab

From this tab, you can access all of Nahimic 3's microphone effects and settings.

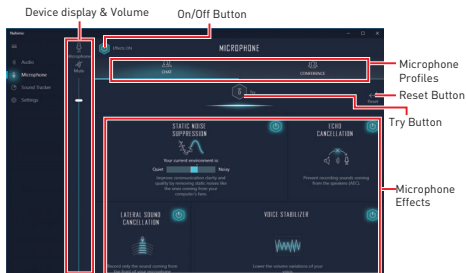

- **Device display and volume** - displays the type of recording device currently being used as input, as well as its current volume.
  - **Mute** - mutes the current mic device.
- **Mic profiles** - allows you to choose between 2 factory mic profiles to fit your experience (Chat or Conference). All profiles can be modified as you wish.
- **On / Off button** - allows you to turn on and off all Nahimic 3's microphone effects in one click.
- **Microphone Effects** - allows you to separately control any of the 4 microphone effects.
  - **Static Noise Suppression** - it removes the static noises like the ones coming from your computer fans.
  - **Echo Cancellation** - improves the voice quality by cancelling the echo.
  - **Lateral Sound Cancellation** - it only records the sound coming from the front of your microphone.
  - **Voice Stabilizer** - Levels the volume of your voice in order to avoid any saturation and maintains a constant and clear communication.
- **Reset Button** - restores the current profile to its default values.
- **Try Button** - Turns the microphone loopback On/Off.

## Sound Tracker Tab

The Sound Tracker is an FPS oriented feature that provides a visual indication localizing the sources of the sounds while in a game. These are represented by dynamic segments pointing the direction of the sounds: the more opaque they are, the stronger the sounds are. Thanks to this feature, players are able to pick up an approaching threat more definitively and easily, thereby being even more dynamic. The Sound Tracker captures the 5.1 and 7.1 sound streams processed by your audio system, and is displayed in the applications and games using DirectX 9, 9c, 10 and 11.

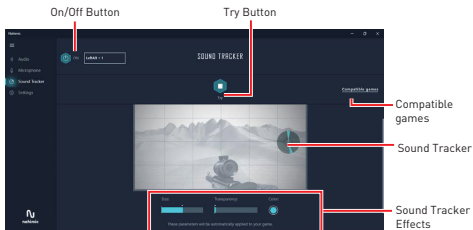

- **ON / OFF Button** - allows you to enable/ disable the Sound Tracker by switching this option ON/ OFF.
- **Try Button** - launch a 7.1 audio sample allowing you to preview how the radar will react in your game.
- **Sound Tracker Effects**
  - **Size** - allows you to adjust the scale of the Sound Tracker, making it look bigger or smaller.
  - **Transparency** - allows you to adjust the transparency of the Sound Tracker, making it look more or less discrete.
  - **Color** - click the colored circle to open the color edition window. You can apply the color you want to the dynamic segments.
- **Compatible games** - clicking this link opens the official Nahimic website, and leads to the list of compatible games able to display the Sound Tracker.

## Settings Tab

In this section, it allows you to select the language of Nahimic 3's UI.

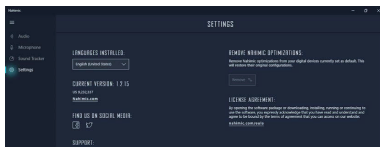

# UEFI BIOS

MSI UEFI BIOS is compatible with UEFI (Unified Extensible Firmware Interface) architecture. UEFI has many new functions and advantages that traditional BIOS cannot achieve, and it will completely replace BIOS in the future. The MSI UEFI BIOS uses UEFI as the default boot mode to take full advantage of the new chipset's capabilities.

## Important

*The term BIOS in this user guide refers to UEFI BIOS unless otherwise noted.*

## UEFI advantages

- Fast booting - UEFI can directly boot the operating system and save the BIOS self-test process. And also eliminates the time to switch to CSM mode during POST.
- Supports for hard drive partitions larger than 2 TB.
- Supports more than 4 primary partitions with a GUID Partition Table (GPT).
- Supports unlimited number of partitions.
- Supports full capabilities of new devices - new devices may not provide backward compatibility.
- Supports secure startup - UEFI can check the validity of the operating system to ensure that no malware tampers with the startup process.

## Incompatible UEFI cases

- **32-bit Windows operating system** - this motherboard supports only Windows 10/Windows 11 64-bit operating system.
- **Older graphics card** - the system will detect your graphics card. When display a warning message **There is no GOP (Graphics Output protocol) support detected in this graphics card.**

## Important

*We recommend that you to replace with a GOP/UEFI compatible graphics card or using integrated graphics from CPU for having normal function.*

## How to check the BIOS mode?

1. Power on your computer.
2. Press **Delete** key, when the **Press DEL key to enter Setup Menu, F11 to enter Boot Menu** message appears on the screen during the boot process.
3. After entering the BIOS, you can check the **BIOS Mode** at the top of the screen.

BIOS Mode: UEFI

## BIOS Setup

The default settings offer the optimal performance for system stability in normal conditions. You should **always keep the default settings** to avoid possible system damage or failure booting unless you are familiar with BIOS.



### Important

- BIOS items are continuously update for better system performance. Therefore, the description may be slightly different from the latest BIOS and should be for reference only. You could also refer to the **HELP** information panel for BIOS item description.
- The BIOS screens, options and settings will vary depending on your system.

## Entering BIOS Setup

Press **Delete** key, when the **Press DEL key to enter Setup Menu, F11 to enter Boot Menu** message appears on the screen during the boot process.

### Function key

- F1:** General Help list
  - F2:** Add/ Remove a favorite item
  - F3:** Enter Favorites menu
  - F4:** Enter CPU Specifications menu
  - F5:** Enter Memory-Z menu
  - F6:** Load optimized defaults
  - F7:** Switch between Advanced mode and EZ mode
  - F8:** Load Overclocking Profile
  - F9:** Save Overclocking Profile
  - F10:** Save Change and Reset\*
  - F12:** Take a screenshot and save it to USB flash drive (FAT/ FAT32 format only).
- Ctrl+F:** Enter Search page

\* When you press F10, a confirmation window appears and it provides the modification information. Select between Yes or No to confirm your choice.

## BIOS User Guide



If you'd like to know more instructions on setting up the BIOS, please refer to

<http://download.msi.com/manual/mb/Intel600BIOS.pdf>

or scan the QR code to access.

## Resetting BIOS

You might need to restore the default BIOS setting to solve certain problems. There are several ways to reset BIOS:

- Go to BIOS and press **F6** to load optimized defaults.
- Short the **Clear CMOS** jumper on the motherboard.
- Press the **Clear CMOS** button on the rear I/O panel.

### **Important**

*Be sure the computer is off before clearing CMOS data. Please refer to the **Clear CMOS jumper/ button** section for resetting BIOS.*

## Updating BIOS

### Updating BIOS with M-FLASH

Before updating:

Please download the latest BIOS file that matches your motherboard model from MSI website. And then save the BIOS file into the USB flash drive.

Updating BIOS:

1. Switch to the target BIOS ROM by Multi-BIOS switch. Please skip this step if your motherboard doesn't has this switch.
2. Insert the USB flash drive that contains the update file into the USB port.
3. Please refer the following methods to enter flash mode.
  - Reboot and press **Ctrl + F5** key during POST and click on **Yes** to reboot the system.

Press <Ctrl+F5> to activate M-Flash for BIOS update.

- Reboot and press **Del** key during POST to enter BIOS. Click the **M-FLASH** button and click on **Yes** to reboot the system.

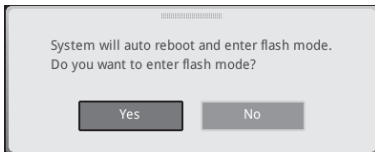

4. Select a BIOS file to perform the BIOS update process.
5. When prompted click on **Yes** to start recovering BIOS.
6. After the flashing process is 100% completed, the system will reboot automatically.



## Updating the BIOS with MSI Center

Before updating:

- Make sure the LAN driver is already installed and the internet connection is set properly.
- Please close all other application software before updating the BIOS.

To update BIOS:

1. Install and launch MSI Center and go to **Support** page.
2. Select **Live Update** and click on **Advance** button.
3. Select the BIOS file and click on **Install** button.
4. The installation reminder will appear, then click the Install button on it.
5. The system will automatically restart to update BIOS.
6. After the flashing process is 100% completed, the system will restart automatically.

# RAID Configuration

The introduction of RAID levels and types are as below:

- RAID 0** breaks the data into blocks which are written to separate hard drives. Spreading the hard drive I/O load across independent channels greatly improves I/O performance.
- RAID 1** provides data redundancy by mirroring data between the hard drives and provides enhanced read performance.
- RAID 5** provides data striping at the byte level and also stripe error correction information. This results in excellent performance and good fault tolerance.
- RAID 10** uses four hard drives to create a combination of RAID 0 and 1 by forming a RAID 0 array from two RAID 1 arrays.

## RAID level comparison

	RAID 0	RAID 1	RAID 5	RAID 10
Minimum # drives	2	2	3	4
Data protection	None	Excellent	Excellent	Excellent
Read performance	Excellent	OK	Good	OK
Write performance	Excellent	Good	OK	Good
Capacity utilization	100%	50%	$67\% - (1-1/n)$	50%

### **Important**

All the information/ volumes/ pictures listed in your system might differ from the illustrations in this appendix.

## Intel RAID User Guide



If you'd like to know more instructions on how to set up Intel RAID, please refer to

<http://download.msi.com/manual/mb/IntelRAID600.pdf>

or scan the QR code to access.

# Intel® Optane™ Memory Configuration

Intel® Optane™ memory is a technology which allows the system to access the data more quickly. It enables the computer to store commonly used data and programs, and keeps them even after powering off the computer. Before you start to install Intel® Optane™ memory, please note that it requires Windows 10/ Windows 11 64-bit operating system.

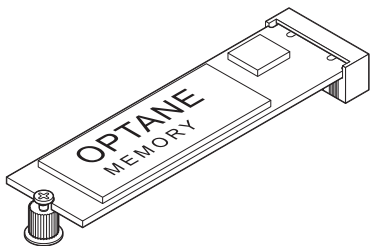

## Intel® Optane™ Memory User Guide



If you'd like to know more instructions on how to enable or remove Intel® Optane™ Memory, please refer to

<http://download.msi.com/manual/mb/Optane600.pdf>

or scan the QR code to access.



After you enable Intel® Optane™ memory, please note the following to prevent damage to your operating system.

- **DO NOT revert back to older version of the BIOS.**
- **DO NOT remove the Intel® Optane™ memory module.**
- **DO NOT replace the CPU that is not supported by Intel® Optane™ Memory.**

# Troubleshooting

Before sending the motherboard for RMA repair, try to go over troubleshooting guide first to see if your got similar symptoms as mentioned below.

## The power is not on.

- Connect the AC power cord to an electrical outlet securely.
- Check if all ATX power connectors like **ATX\_PWR1**, **CPU\_PWR1** are connected from the power supply to the motherboard?
- Some power supply units have a power button on the rear side, make sure the button is turned on.
- Check if the power switch cable is connected to **JFP1** pin header properly.
- Verify the **Clear CMOS** jumper **JBAT1** is set to **Keep DATA**.
- Test with another known working power supply of equal or greater wattage.

## The power is on, but no signal to monitor

- Connect the monitor power cord to a electrical outlet securely.
- Make sure the monitor is turned on.
- Select different inputs on the monitor.
- If 3 long beeps are heard, remove all memory modules and try to install only one memory module in the **DIMMA2** slot first and then restart the computer.
- If 1 long 2 short beeps are heard, remove and reinstall the graphics card and then restart the computer.
- Test with another known working graphics card.

## The computer does not boot after updating the BIOS

- Clear the CMOS.
- Use the secondary BIOS to bootup the system (Only for motherboard with Dual BIOS)

## Lost BIOS password

- Clear the CMOS, but that will cause you to lose all customized settings in the BIOS.

## There is no audio

- Adjust the volume.
- Connect the speakers/headphones to audio ports on the motherboard rear IO panel.
- Remove secondary speakers/headphones, HDMI cables, USB audio devices.
- Test with another known working speaker or headphone.

## There is no network

- Make sure the network chipset driver has been installed.
- Verify if the network cable is properly connected and make sure the LAN port LEDs are properly illuminated.
- Verify your TCP/IP settings.
- Restart or reset your router.
- Test with another known working LAN cable.

## The USB device is not working

- Make sure your USB drive driver has been installed.
- Verify if USB device is listed in Windows® Device Manager.
- Connect the USB device to other USB port on the motherboard rear IO panel.

# Regulatory Notices

## FCC Compliance Statement

Note: This equipment has been tested and found to comply with the limits for a Class B digital device, pursuant to part 15 of the FCC Rules. These limits are designed to provide reasonable protection against harmful interference in a residential installation. This equipment generates, uses and can radiate radio frequency energy and, if not installed and used in accordance with the instructions, may cause harmful interference to radio communications. However, there is no guarantee that interference will not occur in a particular installation. If this equipment does cause harmful interference to radio or television reception, which can be determined by turning the equipment off and on, the user is encouraged to try to correct the interference by one or more of the following measures:

- Reorient or relocate the receiving antenna.
- Increase the separation between the equipment and receiver.
- Connect the equipment into an outlet on a circuit different from that to which the receiver is connected.
- Consult the dealer or an experienced radio/TV technician for help.

Caution: Changes or modifications not expressly approved by the party responsible for compliance could void the user's authority to operate the equipment.



Tested to comply with FCC standards  
FOR HOME OR OFFICE USE

This device complies with part 15 of the FCC Rules. Operation is subject to the following two conditions:

- (1) This device may not cause harmful interference, and
- (2) this device must accept any interference received, including interference that may cause undesired operation.

## CE Conformity



Products bearing the CE marking comply with one or more of the following EU Directives as may be applicable:

RED 2014/53/EU; Low Voltage Directive 2014/35/EU; EMC Directive 2014/30/EU; RoHS Directive 2011/65/EU.

Compliance with these directives is assessed using applicable European Harmonized Standards.

The point of contact for regulatory matters is MSI, MSI-NL Eindhoven 5706 5692 ER Son.

## KC인증서



R-R-MSI-10-7D29

상호: [주]엠에스아이코리아  
제품명: 메인보드  
모델명: 10-7D29  
제조년월: 2021년  
제조자 및 제조국가: MSI/중국

## クラスB情報技術装置

この装置は、クラスB情報技術装置です。この装置は、家庭環境で使用することを目的としていますが、この装置がラジオやテレビジョン受信機に近接して使用されると、受信障害を引き起こすことがあります。取扱説明書に従って正しい取り扱いをして下さい。

VCCI-B

## C-Tick Compliance



N1996

## Battery Information

European Union:



Batteries, battery packs, and accumulators should not be disposed of as unsorted household waste. Please use the public collection system to return, recycle, or treat them in compliance with the local regulations.

Taiwan:



廢電池請回收

For better environmental protection, waste batteries should be collected separately for recycling or special disposal.

California, USA:



The button cell battery may contain perchlorate material and requires special handling when recycled or disposed of in California.

For further information please visit:

<http://www.dtsc.ca.gov/hazardouswaste/perchlorate/>

CAUTION: There is a risk of explosion, if battery is incorrectly replaced.

Replace only with the same or equivalent type recommended by the manufacturer.

## Chemical Substances Information

In compliance with chemical substances regulations, such as the EU REACH Regulation [Regulation EC No. 1907/2006 of the European Parliament and the Council], MSI provides the information of chemical substances in products at:

[https://storage-asset.msi.com/html/popup/csr/evmprt\\_pcm.html](https://storage-asset.msi.com/html/popup/csr/evmprt_pcm.html)

## Environmental Policy

- The product has been designed to enable proper reuse of parts and recycling and should not be thrown away at its end of life.
- Users should contact the local authorized point of collection for recycling and disposing of their end-of-life products.
- Visit the MSI website and locate a nearby distributor for further recycling information.
- Users may also reach us at [gpcontdev@msi.com](mailto:gpcontdev@msi.com) for information regarding proper Disposal, Take-back, Recycling, and Disassembly of MSI products.



## WEEE (Waste Electrical and Electronic Equipment) Statement

ENGLISH

To protect the global environment and as an environmental list, MSI must remind you that...

Under the European Union ("EU") Directive on Waste Electrical and Electronic Equipment, Directive



2002/96/EC, which takes effect on August 13, 2005, products of "electrical and electronic equipment" cannot be discarded as municipal wastes anymore, and manufacturers of covered electronic equipment will be obligated to take back such products at the end of their useful life. MSI will comply with the product take back requirements at the end of life of MSI-branded products that are sold into the EU. You can return these products to local collection points.

#### DEUTSCH

Hinweis von MSI zur Erhaltung und Schutz unserer Umwelt

Gemäß der Richtlinie 2002/96/EG über Elektro- und Elektronik-Altgeräte dürfen Elektro- und Elektronik-Altgeräte nicht mehr als kommunale Abfälle entsorgt werden. MSI hat europaweit verschiedene Sammel- und Recyclingunternehmen beauftragt, die in die Europäische Union in Verkehr gebrachten Produkte, am Ende seines Lebenszyklus zurückzunehmen. Bitte entsorgen Sie dieses Produkt zum gegebenen Zeitpunkt ausschliesslich an einer lokalen Altgerätesammelstelle in Ihrer Nähe.

#### FRANÇAIS

En tant qu'écologiste et afin de protéger l'environnement, MSI tient à rappeler ceci...

Au sujet de la directive européenne (EU) relative aux déchets des équipements électriques et électroniques, directive 2002/96/EC, prenant effet le 13 août 2005, que les produits électriques et électroniques ne peuvent être déposés dans les décharges ou tout simplement mis à la poubelle. Les fabricants de ces équipements seront obligés de récupérer certains produits en fin de vie. MSI prendra en compte cette exigence relative au retour des produits en fin de vie au sein de la communauté européenne. Par conséquent vous pouvez retourner localement ces matériels dans les points de collecte.

#### РУССКИЙ

Компания MSI предпринимает активные действия по защите окружающей среды, поэтому напоминаем вам, что....

В соответствии с директивой Европейского Союза (ЕС) по предотвращению загрязнения окружающей среды использованным электрическим и электронным оборудованием (директива WEEE 2002/96/EC), вступающей в силу 13 августа 2005 года, изделия, относящиеся к электрическому и электронному оборудованию, не могут рассматриваться как бытовой мусор, поэтому производители вышелеперечисленного электронного оборудования обязаны принимать его для переработки по окончании срока службы. MSI обязуется соблюдать требования по приему продукции, проданной под маркой MSI на территории ЕС, в переработку по окончании срока службы. Вы можете вернуть эти изделия в специализированные пункты приема.

#### ESPAÑOL

MSI como empresa comprometida con la protección del medio ambiente, recomienda:

Bajo la directiva 2002/96/EC de la Unión Europea en materia de desechos y/o equipos electrónicos, con fecha de rigor desde el 13 de agosto de 2005, los productos clasificados como "eléctricos y equipos electrónicos" no pueden ser depositados en los contenedores habituales de su municipio, los

fabricantes de equipos electrónicos, están obligados a hacerse cargo de dichos productos al término de su período de vida. MSI estará comprometido con los términos de recogida de sus productos vendidos en la Unión Europea al final de su período de vida. Usted debe depositar estos productos en el punto limpio establecido por el ayuntamiento de su localidad o entregar a una empresa autorizada para la recogida de estos residuos.

#### NEEDERLANDS

Om het milieu te beschermen, wil MSI u eraan herinneren dat....

De richtlijn van de Europese Unie (EU) met betrekking tot Vervuiling van Elektrische en Electronische producten (2002/96/EC), die op 13 Augustus 2005 in zal gaan kunnen niet meer beschouwd worden als vervuiling. Fabrikanten van dit soort producten worden verplicht om producten retour te nemen aan het eind van hun levenscyclus. MSI zal overeenkomstig de richtlijn handelen voor de producten die de merknaam MSI dragen en verkocht zijn in de EU. Deze goederen kunnen geretourneerd worden op lokale inzamelingspunten.

#### SRPSKI

Da bi zaštitili prirodnu sredinu, i kao preduzeće koje vodi računa o okolini i prirodnoj sredini, MSI mora da vas podesti da....

Po Direktivi Evropske unije ("EU") o odbačenoj elektonskoj i električnoj opremi, Direktiva 2002/96/EC, koja stupa na snagu od 13. Avgusta 2005, proizvodi koji spadaju pod "elektonsku i električnu opremu" ne mogu više biti odbačeni kao običan otpad i proizvođači ove opreme biće prinudeni da uzmu natrag ove proizvode na kraju njihovog uobičajenog veka trajanja. MSI će poštovati zahtev o preuzimanju ovakvih proizvoda kojima je istekao vek trajanja, koji imaju MSI oznaku i koji su prodati u EU. Ove proizvode možete vratiti na lokalnim mestima za prikupljanje.

#### POLSKI

Aby chronić nasze środowisko naturalne oraz jako firma dbająca o ekologię, MSI przypomina, że... Zgodnie z Dyrektywą Unii Europejskiej ("UE") dotyczącą odpadów produktów elektrycznych i elektronicznych (Dyrektywa 2002/96/EC), która wchodzi w życie 13 sierpnia 2005, tzw. "produkty oraz wyposażenie elektryczne i elektroniczne" nie mogą być traktowane jako śmieci komunalne, tak więc producenci tych produktów będą zobowiązani do odbiora ich w momencie gdy produkt jest wycofywany z użycia. MSI wypetni wymagania UE, przyjmując produkty (sprzedawane na terenie Unii Europejskiej) wycofywane z użycia. Produkty MSI będzie można zwracać w wyznaczonych punktach zbiorczych.

#### TÜRKÇE

Çevreci özelliğiyle bilinen MSI dünyada çevreyi korumak için hatırlar: Avrupa Birliği (AB) Kararnamesi Elektrik ve Elektronik Malzeme Atığı, 2002/96/EC Kararnamesi altında 13 Ağustos 2005 tarihinden itibaren geçerli olmak üzere, elektrikli ve elektrönik malzeme türü diğer atıklar gibi çöpe atılmayacak ve bu elektrönik cihazların üreticileri, cihazların kullanım süreleri bittikten sonra ürünleri geri toplamakla yükümlü olacaktır. Avrupa Birliği'ne satılan MSI markalı ürünlerin kullanım süreleri bittiğinde MSI ürünlerin geri alınması isteği ile işbirliği içerisinde olacaktır. Ürünlerinizi yerel toplama noktalarına bırakabilirsiniz.

## ČESKY

Záleží nám na ochraně životního prostředí - společnost MSI upozorňuje...

Podle směrnice Evropské unie ("EU") o likvidaci elektrických a elektronických výrobků 2002/96/EC platné od 13. srpna 2005 je zakázáno likvidovat "elektrické a elektronické výrobky" v běžném komunálním odpadu a výrobci elektrických výrobků, na které se tato směrnice vztahuje, budou povinni odebírat takové výrobky zpět po skončení jejich životnosti. Společnost MSI splní požadavky na odebrání výrobků značky MSI, prodávaných v zemích EU, po skončení jejich životnosti. Tyto výrobky můžete odevzdat v místních sběrnách.

## MAGYAR

Annak érdekében, hogy környezetünket megvédjük, illetve környezetvédelemtől fellépve az MSI emlékezteti Önt, hogy ...

Az Európai Unió [„EU”] 2005. augusztus 13-án hatályba lépett, az elektromos és elektronikus berendezések hulladékairól szóló 2002/96/EK irányelve szerint az elektromos és elektronikus berendezések többé nem kezelhetők lakossági hulladékként, és az ilyen elektronikus berendezések gyártói kötelesek válnak az ilyen termékek visszavételére azok hasznos élettartama végén. Az MSI betartja a termékviszavétellel kapcsolatos követelményeket az MSI márkanev alatt az EU-n belül értékesített termékek esetében, azok élettartamának végén. Az ilyen termékeket a legközelebbi gyűjtőhelyre viheti.

## ITALIANO

Per proteggere l'ambiente, MSI, da sempre amica della natura, ti ricorda che....

In base alla Direttiva dell'Unione Europea (EU) sullo Smaltimento dei Materiali Elettrici ed Elettronici, Direttiva 2002/96/EC in vigore dal 13 Agosto 2005, prodotti appartenenti alla categoria dei Materiali Elettrici ed Elettronici non possono più essere eliminati come rifiuti municipali: i produttori di detti materiali saranno obbligati a ritirare ogni prodotto alla fine del suo ciclo di vita. MSI si adegnerà a tale Direttiva ritirando tutti i prodotti marchiati MSI che sono stati venduti all'interno dell'Unione Europea alla fine del loro ciclo di vita. È possibile portare i prodotti nel più vicino punto di raccolta

## 日本JIS C 0950材質宣言

日本工業規格JIS C 0950により、2006年7月1日以降に販売される特定分野の電気および電子機器について、製造者による含有物質の表示が義務付けられます。

[https://storage-asset.msi.com/html/popup/csr/emmm\\_jp.html](https://storage-asset.msi.com/html/popup/csr/emmm_jp.html)

## India RoHS

This product complies with the "India E-waste (Management and Handling) Rule 2011" and prohibits use of lead, mercury, hexavalent chromium, polybrominated biphenyls or polybrominated diphenyl ethers in concentrations exceeding 0.1 weight % and 0.01 weight % for cadmium, except for the exemptions set in Schedule 2 of the Rule.

## Türkiye EEE yönetmeliği

Türkiye Cumhuriyeti: EEE Yönetmeliğine Uygundur

## Україна обмеження на наявність небезпечних речовин

Обладнання відповідає вимогам Технічного регламенту щодо обмеження використання деяких небезпечних речовин в електричному та електронному обладнанні, затвердженого постановою Кабінету Міністрів України від 3 грудня 2008 № 1057.

## Việt Nam RoHS

Kể từ ngày 01/12/2012, tất cả các sản phẩm do công ty MSI sản xuất tuân thủ Thông tư số 30/2011/TT-BCT quy định tạm thời về giới hạn hàm lượng cho phép của một số hóa chất độc hại có trong các sản phẩm điện, điện tử

## Wireless Radio Use

This device is restricted to indoor use when operating in the 2.4GHz, 5GHz, 6GHz frequency band.

Cet appareil doit être utilisé à l'intérieur.

당해 무선설비는 운용중 전파혼신 가능성이 있음.

この製品は、周波数帯域 2.4GHz, 5GHz, 6GHz で動作しているときは、屋内においてのみ使用可能です。

## NCC無線設備警告聲明

工作頻率2.4GHz, 5GHz, 6GHz該頻段限於室內使用。

經型式認證合格之低功率射頻電機，非經許可，公司、商號或使用者均不得擅自變更頻率、加大功率或變更原設計之特性及功能。

低功率射頻電機之使用不得影響飛航安全及干擾合法通信；經發現有干擾現象時，應立即停用，並改善至無干擾時方得繼續使用。前項合法通信，指依電信法規定作業之無線電通信。低功率射頻電機須忍受合法通信或工業、科學及醫療用電波輻射性電機設備之干擾。

## Products with radio functionality (EMF)

This product incorporates a radio transmitting and receiving device. For computers in normal use, a separation distance of 20 cm ensures that radio frequency exposure levels comply with EU requirements. Products designed to be operated at closer proximities, such as tablet computers, comply with applicable EU requirements in typical operating positions. Products can be operated without maintaining a separation distance unless otherwise indicated in instructions specific to the product.

## Restrictions for products with radio functionality

CAUTION: IEEE 802.11x wireless LAN with 5.15-5.35 GHz frequency band is restricted for indoor use only in all European Union member states, EFTA (Iceland, Norway, Liechtenstein), and most other

European countries (e.g., Switzerland, Turkey, Republic of Serbia). Using this WLAN application outdoors might lead to interference issues with existing radio services.



## Radio frequency bands and maximum power levels

Features: Wi-Fi 6E, BT

Frequency Range:

2412-2484MHz,	5150-5350MHz (RLAN 1),
5470-5725MHz (RLAN 2),	5725-5875MHz (RLAN 3),
5875-5925MHz (RLAN 4),	5925-6425MHz

Max Power Level:

2.4 GHz: 20dBm; 5 GHz: 23dBm; 6 GHz: 23dBm

## MS-7D29主板产品中有害物质的名称及含量

部件名称	有害物质					
	铅 (Pb)	汞 (Hg)	镉 (Cd)	六价铬 (Cr(VI))	多溴联苯 (PBB)	多溴二苯醚 (PBDE)
印刷电路板组件*	×	○	○	○	○	○
电池** 	×	○	○	○	○	○
外部信号连接头	×	○	○	○	○	○
线材	×	○	○	○	○	○

本表格依据 SJ/T 11364 的规定编制。

○: 表示该有害物质在该部件所有均质材料中的含量均在 GB/T 26572 规定的限量要求以下。

×: 表示该有害物质至少在该部件的某一均质材料中的含量超出 GB/T 26572 规定的限量要求,但所有部件都符合欧盟RoHS要求。

\* 印刷电路板组件: 包括印刷电路板及其构成的零部件。

\*\* 电池本体上如有环保使用期限标识,以本体标识为主。

■ 上述有毒有害物质或元素清单会依型号之部件差异而有所增减。

■ 产品部件本体上如有环保使用期限标识,以本体标识为主。

## 限用物質含有情況標示聲明書

設備名稱: 電腦主機板		型號(型式): MS-7D29					
單元	限用物質及其化學符號						
	鉛 (Pb)	汞 (Hg)	鎘 (Cd)	六價鉻 (Cr <sup>VI</sup> )	多溴聯苯 (PBB)	多溴二苯醚 (PBDE)	
電路板	○	○	○	○	○	○	
電子元件	—	○	○	○	○	○	
金屬機構件	—	○	○	○	○	○	
塑膠機構件	○	○	○	○	○	○	

備考1. “超出0.1 wt %”及“超出0.01 wt %”係指限用物質之百分比含量超出百分比含量基準值。

備考2. “○”係指該項限用物質之百分比含量未超出百分比含量基準值。

備考3. “—”係指該項限用物質為排除項目。

## Copyright

**msi** Micro-Star Int'l Co., Ltd.

Copyright © 2021 All rights reserved.

The MSI logo used is a registered trademark of Micro-Star Int'l Co., Ltd. All other marks and names mentioned may be trademarks of their respective owners. No warranty as to accuracy or completeness is expressed or implied. MSI reserves the right to make changes to this document without prior notice.

## Revision History

Version 1.0, 2021/11, First release.

## Technical Support

If a problem arises with your system and no solution can be obtained from the user guide, please contact your place of purchase or local distributor. Alternatively, please try the following help resources for further guidance.

- Visit the MSI website for technical guide, BIOS updates, driver updates, and other information: <http://www.msi.com>
- Register your product at: <http://register.msi.com>

