

# Aegis Series

*Personal Computer*

---

Aegis B931

# Contents

Copyright and Trademarks Notice .....	iii
Revision .....	iii
Upgrade and Warranty .....	iv
Acquisition of Replaceable Parts .....	iv
Technical Support .....	iv
Chemical Substances Information .....	v
Battery Information .....	v
Safety Instructions .....	vi
CE Conformity .....	viii
FCC-B Radio Frequency Interference Statement .....	viii
WEEE Statement .....	ix
RoHS Statement .....	ix
<b>Overview .....</b>	<b>1-1</b>
Packing Contents .....	1-2
System Overview .....	1-3
<b>Getting Started .....</b>	<b>2-1</b>
Safety & Comfort Tips .....	2-2
Hardware Setup .....	2-3
Connecting Thunderbolt Devices via Daisy-chain (Optional) .....	2-4
<b>System Operations .....</b>	<b>3-1</b>
Power Management .....	3-2
Network Connection (Windows 10) .....	3-4
System Recovery (Windows 10) .....	3-7
System Recovery (F3 Hotkey Recovery) .....	3-11

# Copyright and Trademarks Notice

Copyright © Micro-Star Int'l Co., Ltd. All rights reserved. The MSI logo used is a registered trademark of Micro-Star Int'l Co., Ltd. All other marks and names mentioned may be trademarks of their respective owners. No warranty as to accuracy or completeness is expressed or implied. MSI reserves the right to make changes to this document without prior notice.

## Revision

Revision	Date
V1.2	2021/3

## Upgrade and Warranty

Please note that certain components preinstalled in the computer may be upgradable or replaceable by user's request. To learn more about upgrade limitation, please refer to the specifications in the User's Manual. For any further information about the computer users purchased, please contact the local dealer. Do not attempt to upgrade or replace any component of the computer if you are not an authorized dealer or service center, since it may cause the warranty void. It is strongly recommended that you contact the authorized dealer or service center for any upgrade or replace service.

## Acquisition of Replaceable Parts

Please be noticed that the acquisition of replaceable parts (or compatible ones) of the computer users purchased in certain countries or territories may be fulfilled by the manufacturer within 5 years at most since the computer has been discontinued, depending on the official regulations declared at the time. Please contact the manufacturer via <https://www.msi.com/support/> for the detailed information about the acquisition of spare parts.

## Technical Support

If a problem arises with your computer and no solution can be obtained from the user's manual, please contact your place of purchase or local distributor. Alternatively, please try the following help resources for further guidance. Visit the MSI website for technical guide, BIOS updates, driver updates and other information via <https://www.msi.com/support/>

## Chemical Substances Information

In compliance with chemical substances regulations, such as the EU REACH Regulation (Regulation EC No. 1907/2006 of the European Parliament and the Council), MSI provides the information of chemical substances in computers at:

[https://www.msi.com/html/popup/csr/evmtprrt\\_pcm.html](https://www.msi.com/html/popup/csr/evmtprrt_pcm.html)

## Battery Information

---



European Union:

Batteries, battery packs, and accumulators should not be disposed of as unsorted household waste. Please use the public collection computer to return, recycle, or treat them in compliance with the local regulations.

---



Taiwan:

For better environmental protection, waste batteries should be collected separately for recycling or special disposal.

---

廢電池請回收

---

California, USA:

The button cell battery may contain perchlorate material and requires special handling when recycled or disposed of in California.

For further information please visit: <https://dtsc.ca.gov/perchlorate/>

---

# Safety Instructions

---



- ☐ Read the safety instructions carefully and thoroughly.
  - ☐ All cautions and warnings on the computer or user's manual should be noted.
- 



- ☐ Make sure that the power voltage is within its safety range and has been adjusted properly to the value of 100~240V before connecting the computer to the power outlet.
  - ☐ If the power cord comes with a 3-pin plug, do not disable the protective earth pin from the plug. The computer must be connected to an earthed mains socket-outlet.
  - ☐ Always unplug the AC power cord before installing any add-on card or module to the computer.
  - ☐ Always disconnect the AC power cord or switch the wall socket off if the computer would be left unused for a certain time to achieve zero energy consumption.
  - ☐ Place the power cord in a way that people are unlikely to step on it. Do not place anything on the power cord.
  - ☐ If this computer comes with an adapter, use only the MSI provided AC adapter approved for use with this computer.
  - ☐ Power Rating: 750W, 100-240V~, 50-60Hz, 10-5A.
- 

Please take special precautions if this computer comes with a battery.



- ☐ Danger of explosion if battery is incorrectly replaced. Replace only with the same or equivalent type recommended by the manufacturer.
  - ☐ Avoid disposal of a battery into fire or a hot oven, or mechanically crushing or cutting of a battery, which can result in an explosion.
  - ☐ Avoid leaving a battery in an extremely high temperature or extremely low air pressure environment that can result in an explosion or the leakage of flammable liquid or gas.
  - ☐ Do not ingest battery. If the coin/button cell battery is swallowed, it can cause severe internal burns and can lead to death. Keep new and used batteries away from children.
- 



- ☐ To reduce the possibility of heat-related injuries or of overheating the computer, do not place the computer on a soft, unsteady surface or obstruct the computer air ventilators.
  - ☐ Use this computer only on a hard, flat and steady surface.
- 



- ☐ Keep this computer away from humidity and high temperature.
  - ☐ Do not leave the computer in an unconditioned environment with a storage temperature above 60°C or below 0°C, which may damage the computer.
  - ☐ The maximum operating temperature is around 35°C.
-



Never pour any liquid into the opening that could damage or cause electrical shock.



Always keep the strong magnetic or electrical objects away from the computer.



If any of the following situations arises, get the computer checked by service personnel:

- ❑ The power cord or plug is damaged.
- ❑ Liquid has penetrated into the computer.
- ❑ The computer has been exposed to moisture.
- ❑ The computer does not work well or you can not get it work according to user's manual.
- ❑ The computer has dropped and damaged.
- ❑ The computer has obvious sign of breakage.

#### Green Product Features

- ❑ Reduced energy consumption during use and stand-by
- ❑ Limited use of substances harmful to the environment and health
- ❑ Easily dismantled and recycled
- ❑ Reduced use of natural resources by encouraging recycling
- ❑ Extended product lifetime through easy upgrades
- ❑ Reduced solid waste production through take-back policy



#### Environmental Policy

- ❑ The product has been designed to enable proper reuse of parts and recycling and should not be thrown away at its end of life.
- ❑ Users should contact the local authorized point of collection for recycling and disposing of their end-of-life products.
- ❑ Visit the MSI website and locate a nearby distributor for further recycling information.
- ❑ Users may also reach us at [gpcontdev@msi.com](mailto:gpcontdev@msi.com) for information regarding proper disposal, take-back, recycling, and disassembly of MSI products.

## CE Conformity

Hereby, Micro-Star International CO., LTD declares that this computer is in compliance with the essential safety requirements and other relevant provisions set out in the European Directive.



## FCC-B Radio Frequency Interference Statement



This computer has been tested and found to comply with the limits for a Class B digital device, pursuant to Part 15 of the FCC Rules. These limits are designed to provide reasonable protection against harmful interference in a residential installation. This computer generates, uses and can radiate radio frequency energy and, if not installed and used in accordance with the instruction manual, may cause harmful interference to radio communications. However, there is no guarantee that interference will not occur in a particular installation. If this computer does cause harmful interference to radio or television reception, which can be determined by turning the computer off and on, the user is encouraged to try to correct the interference by one or more of the measures listed below:

- Reorient or relocate the receiving antenna.
- Increase the separation between the computer and receiver.
- Connect the computer into an outlet on a circuit different from that to which the receiver is connected.
- Consult the dealer or an experienced radio/television technician for help.

### Notice 1

The changes or modifications not expressly approved by the party responsible for compliance could void the user's authority to operate the computer.

### Notice 2

Shielded interface cables and AC power cord, if any, must be used in order to comply with the emission limits.

This device complies with Part 15 of the FCC Rules. Operation is subject to the following two conditions:

1. this device may not cause harmful interference, and
2. this device must accept any interference received, including interference that may cause undesired operation.

### MSI Computer Corp.

901 Canada Court, City of Industry, CA 91748, USA  
(626) 913-0828  
www.msi.com



## WEEE Statement

Under the European Union ("EU") Directive on Waste Electrical and Electronic Computer, Directive 2012/19/EU, computers of "electrical and electronic computer" cannot be discarded as municipal waste anymore and manufacturers of covered electronic computer will be obligated to take back such computers at the end of their useful life.



## RoHS Statement

### Japan JIS C 0950 Material Declaration

A Japanese regulatory requirement, defined by specification JIS C 0950, mandates that manufacturers provide material declarations for certain categories of electronic computers offered for sale after July 1, 2006.

[https://storage-asset.msi.com/html/popup/csr/cemm\\_jp.html](https://storage-asset.msi.com/html/popup/csr/cemm_jp.html)

## India RoHS

This computer complies with the "India E-waste (Management and Handling) Rule 2011" and prohibits use of lead, mercury, hexavalent chromium, polybrominated biphenyls or polybrominated diphenyl ethers in concentrations exceeding 0.1 weight % and 0.01 weight % for cadmium, except for the exemptions set in Schedule 2 of the Rule.

## Turkey EEE regulation

Conforms to the EEE Regulations of the Republic Of Turkey.

## Ukraine restriction of hazardous substances

The computer complies with requirements of the Technical Regulation, approved by the Resolution of Cabinet of Ministry of Ukraine as of December 3, 2008 № 1057, in terms of restrictions for the use of certain dangerous substances in electrical and electronic computer.

## Vietnam RoHS

As from December 1, 2012, all computers manufactured by MSI comply with Circular 30/2011/TT-BCT temporarily regulating the permitted limits for a number of hazardous substances in electronic and electric computers.



# 1

## Overview

Sturdy, stable and solid, the MSI Aegis is loaded with the perfect ammunition for PC gamers who do not want to compromise on gaming performance. Housing a highly appraised MSI GAMING motherboard and equipped with unrelenting tools of efficiency, power, cooling and low-noise, the MSI Aegis embodies what every gamer craves for: victory.

# Packing Contents

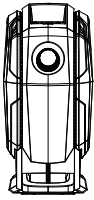

Aegis

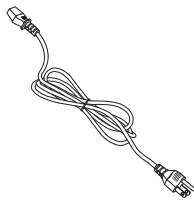

AC Power Cord

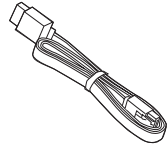

2.5" / 3.5" SATA Cable  
(Optional)



User Manual  
(Optional)



Quick Guide



Warranty Card/ Book



Mouse  
(Optional)

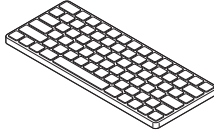

Keyboard  
(Optional)

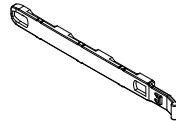

3.5" HDD Bracket  
(Optional)



2.5" Screw  
(Optional)

\* Please contact us immediately if any of the items is damaged or missing.  
\* The illustrations are for reference only and your packing contents may slightly vary depending on the model you purchased.

# System Overview

## ➤ Front View

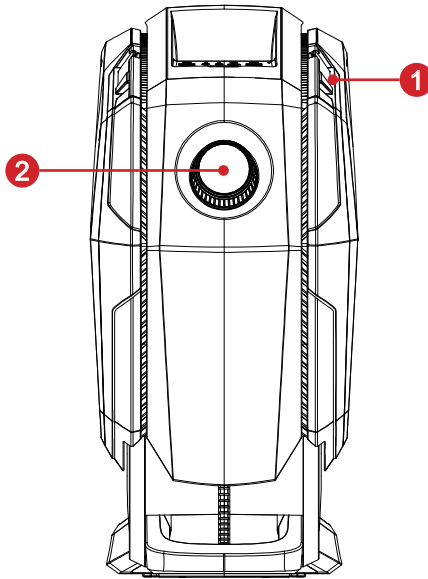

### 1 Headset Holder

Pull out the hanger, then a headset can be hung on the holder.

### 2 Gaming Dial

Gaming Dial displays system information and supports quick switch between functions like Mystic Light/ audio volume or game launch. Please link to URL by scanning the QR code to read more information on your phone or tablet.



► Rear View

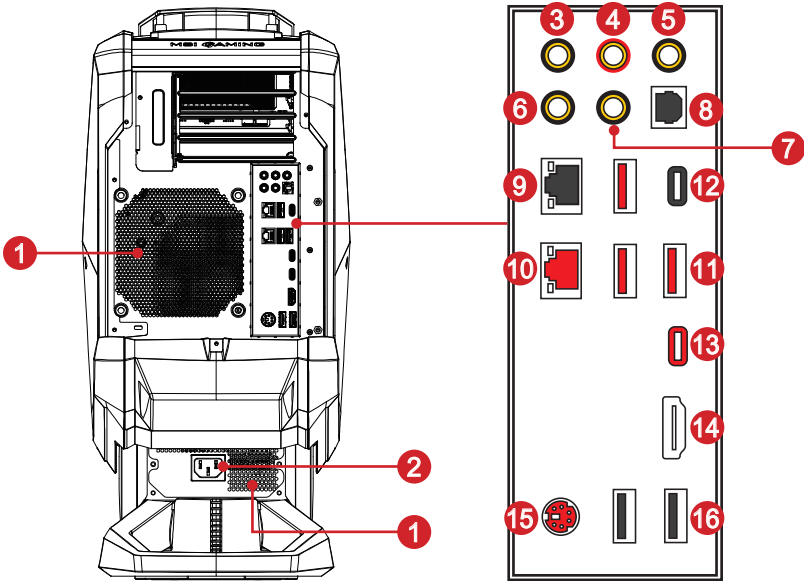

**1 Ventilator**

The ventilator on the enclosure is used for air convection and to prevent the equipment from overheating. Do not cover the ventilator.

**2 Power Jack**

Power supplied through this jack supplies power to your system.

**3 Line-In**

Used for connecting external audio outputting devices.

**SS-Out**

Side surround sound line out in 7.1 channel mode.

**4 Line-Out**

This connector is provided for headphones or speakers.

**5 Mic-In**

This connector is provided for microphones.

- 6 CS-Out**  
Center/ Subwoofer Out in 5.1/ 7.1 channel mode.

- 7 RS-Out**  
Rear-Surround Out in 4/ 5.1/ 7.1 channel mode.

- 8 S/PDIF-Out**  
This S/PDIF (Sony & Philips Digital Interconnect Format) connector is provided for digital audio transmission to external speakers through an optical fiber cable.

- 9 RJ-45 LAN Jack (2.5G)**  
The standard RJ-45 LAN jack is provided for connection to the Local Area Network (LAN). You can connect a network cable to it.



LED	Color	LED State	Condition
Left	Yellow	Off	LAN link is not established.
		On (steady state)	LAN link is established.
		On (blinking)	The computer is communicating with another computer on the LAN.
Right	Green	Off	10 Mbit/sec data rate is selected.
		On	100 Mbit/sec data rate is selected.
		On	1000 Mbit/sec data rate is selected.
	Orange	On	2500 Mbit/sec data rate is selected.

- 10 RJ-45 LAN Jack (1G)**  
The standard RJ-45 LAN jack is provided for connection to the Local Area Network (LAN). You can connect a network cable to it.



LED	Color	LED State	Condition
Left	Yellow	Off	LAN link is not established.
		On (steady state)	LAN link is established.
		On (blinking)	The computer is communicating with another computer on the LAN.
Right	Green	Off	10 Mbit/sec data rate is selected.
		On	100 Mbit/sec data rate is selected.
	Orange	On	1000 Mbit/sec data rate is selected.

**11 USB 3.2 Gen 2 Port (Type-A)**

USB 3.2 Gen 2, the SuperSpeed USB 10Gbps, delivers high-speed data transfer for various devices, such as storage devices, hard drives, video cameras, etc.

**12 USB 3.2 Gen 2x2 Port (Type-C)**

USB 3.2 Gen 2x2, the SuperSpeed USB 20Gbps, delivers high-speed data transfer for various devices, such as storage devices, hard drives, video cameras, etc. The slim and sleek USB Type-C connector features reversible plug orientation and up to 5V/3A power supply for external devices.

**13 Thunderbolt™ 4 Port (USB Type-C) (Optional)**

- Support up to 40Gbps transfer rate with Thunderbolt devices.
- Support up to 20Gbps transfer rate with USB 4 devices.
- Support up to 10Gbps transfer rate with USB 3.2 devices.
- Support up to 5V/3A, 9V/3A, 15V/3A, and 20V/3A power charging.
- Thunderbolt™ 4 port can daisy-chain up to three Thunderbolt 4 devices or five Thunderbolt 3 devices.
- Support up to 8K 60Hz display.

**Important**

- Graphics specifications may vary depending on the installed CPU.
- For processors without integrated graphics, connect your monitor to the discrete graphics card.

**14 HDMI 2.0b with HDR Port**   
HIGH-DEFINITION MULTIMEDIA INTERFACE

Supports a maximum resolution of 4K 60Hz.

**Important**

- Graphics specifications may vary depending on the installed CPU.
- For processors without integrated graphics, connect your monitor to the discrete graphics card.

**15 PS/2® Keyboard/ Mouse Combo Port**

The PS/2 keyboard/ mouse DIN connector for PS/2 keyboard/ mouse.

**16 USB 2.0 Port (Type-A)**

The USB (Universal Serial Bus) port is for attaching USB devices such as keyboard, mouse, or other USB-compatible devices. It supports up to 480Mbit/s (Hi-Speed) data transfer rate.



## ► Top View

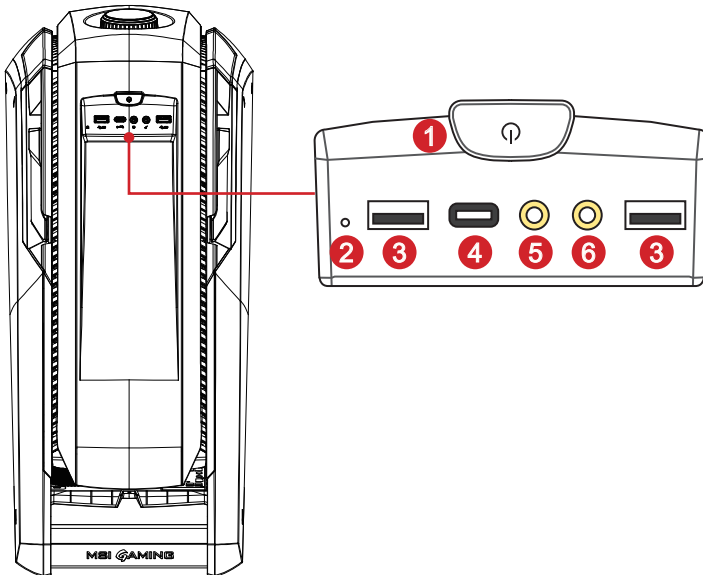

### 1 Power Button/ LED

Press the power button to turn the system on and off. LED glows when the equipment power is turned on. LED goes off when the equipment is turned off.

### 2 Drive Activity Indicator

LED blinks when the system is accessing the internal storage drives.

### 3 USB 3.2 Gen 1 Port (Type-A)

USB 3.2 Gen 1, the SuperSpeed USB, delivers up to 5Gbps high-speed data transfer for various devices, such as storage devices, hard drives, video cameras, etc.

### 4 USB 3.2 Gen 2 Port (Type-C)

USB 3.2 Gen 2, the SuperSpeed USB 10Gbps, delivers high-speed data transfer for various devices, such as storage devices, hard drives, video cameras, etc. The slim and sleek USB Type-C connector features reversible plug orientation and up to 5V/3A power supply for external devices.

5

### **Headphone Jack**

This connector is provided for headphones or speakers.

6

### **Microphone Jack**

This connector is provided for microphones.

---

### **Important**

*High-speed devices are recommended for USB 3.2 ports whereas low-speed devices, such as mouse or keyboard, are suggested to be plugged into the USB 2.0 ports.*

# 2

## Getting Started

This chapter provides you with the information on hardware setup procedures. While connecting peripheral devices, be careful in holding the devices and use a grounded wrist strap to avoid static electricity.

# Safety & Comfort Tips

Choosing a good workspace is important if you have to work with your PC for a long period of time.

1. Your work area should have enough illumination.
2. Choose the proper desk and chair and adjust their height to fit your posture when operating.
3. When sitting on the chair, sit straight and keep a good posture. Adjust the chair's back (if available) to support your back comfortably.
4. Place your feet flat and naturally on the floor, so that your knees and elbows have the proper position (about 90-degree) when operating.
5. Put your hands on the desk naturally to support your wrists.
6. Avoid using your PC in a place where discomfort may occur.
7. The PC is an electrical device. Please treat it with great care to avoid personal injury.

# Hardware Setup

## **Important**

- *The illustrations are for reference only. Your system may vary in appearance.*
- *Please make sure the system has been grounded to earth through the AC power cord and the electrical outlet before powering on the system.*

### ➤ **Connecting Peripherals**

Connect the cables of keyboard, mouse, LAN, monitor, etc.

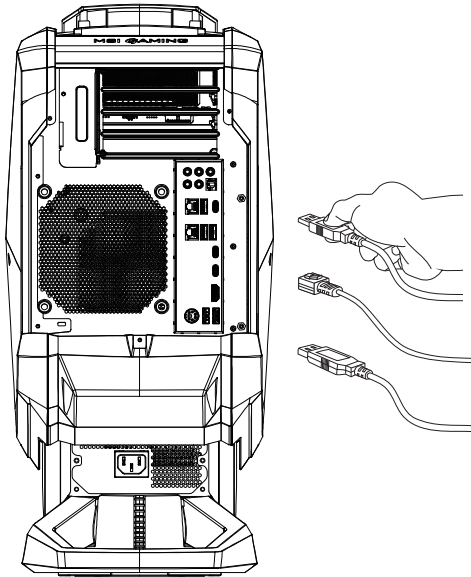

# Connecting Thunderbolt Devices via Daisy-chain (Optional)

Daisy-chain is a method of connecting multiple devices to a PC with only one output terminal.

Daisy-chain allows you to connect multiple Thunderbolt devices to a single Thunderbolt port on the rear IO panel.

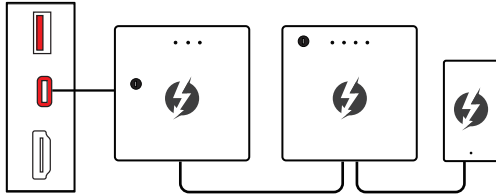

You can also daisy chain 2 monitors on the rear IO panel. Please note that monitors should be the last devices on the chain.

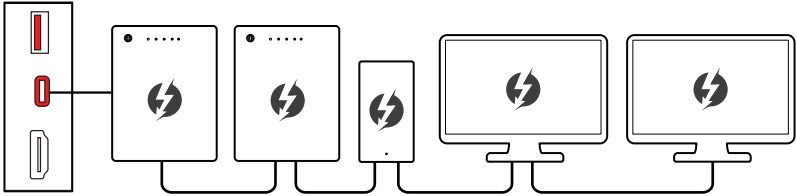

If you want to connect USB devices, please place them at the end of the chain.

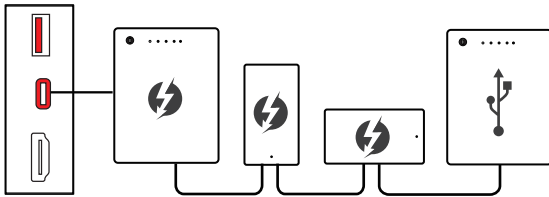

## ► Connecting the AC Power and Power On

1. Connect the power cord to the system.
2. Connect the power cord to the electrical outlet.
3. Press the power button to power on the system.

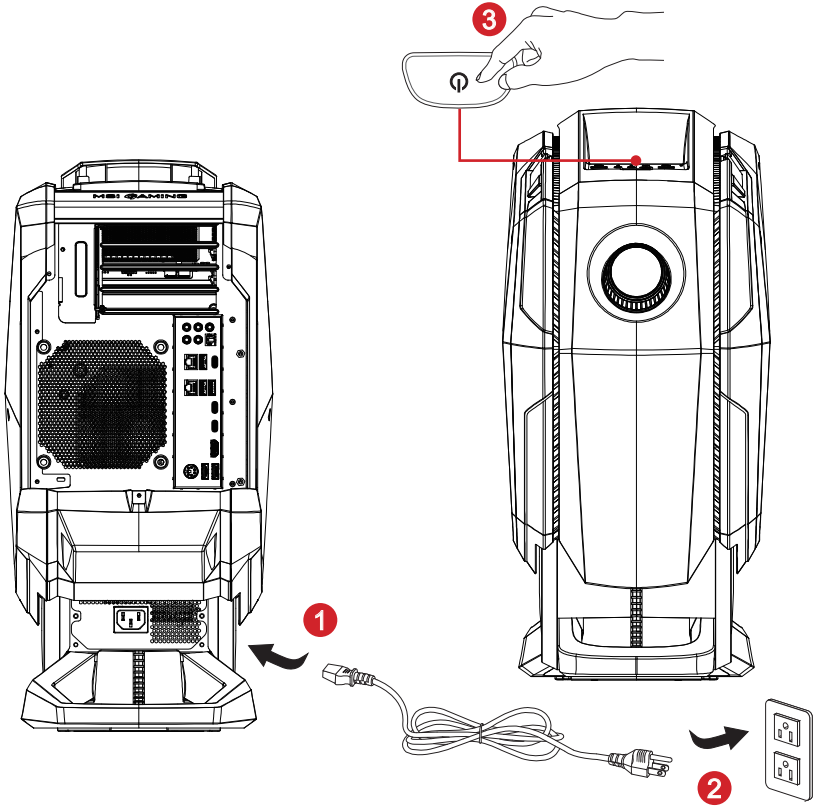

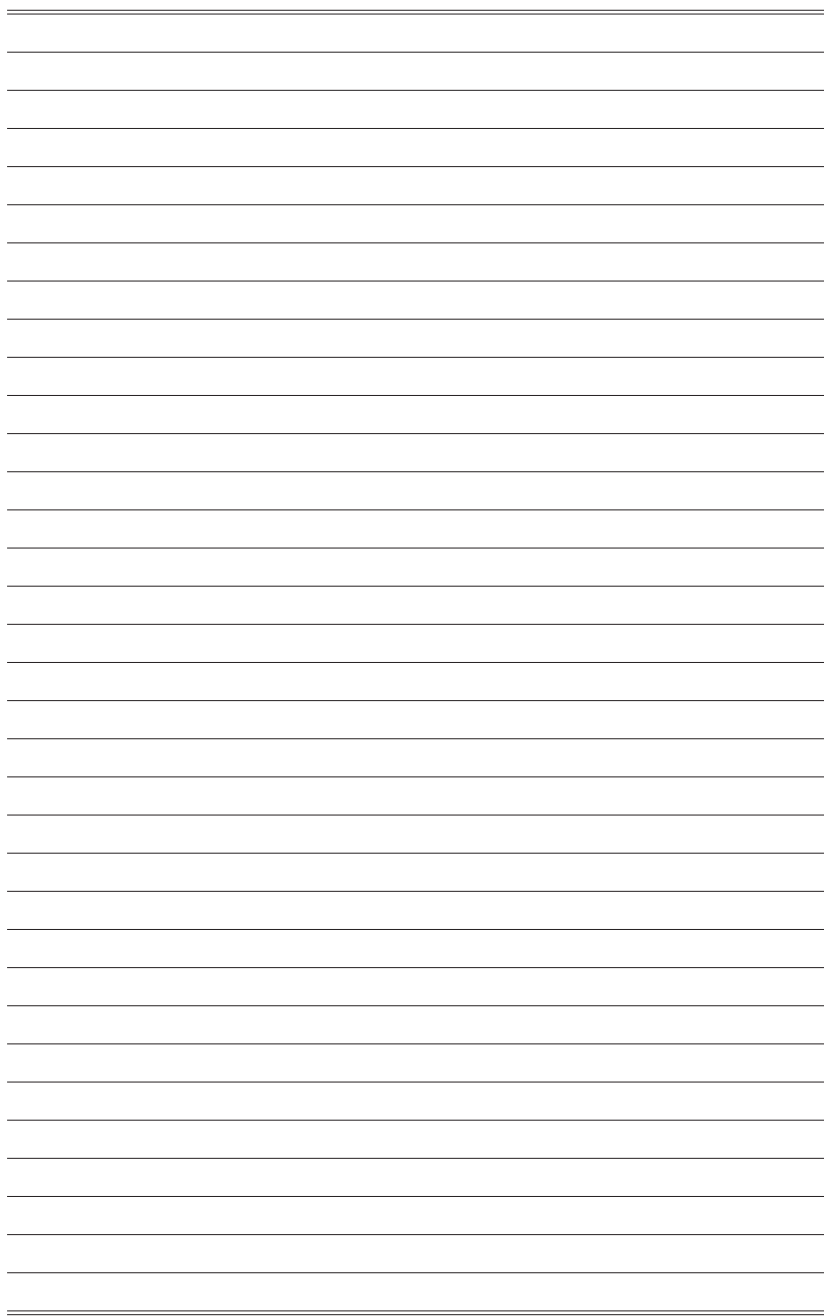



# 3

## System Operations

This chapter provides you with essential information on system operations.

### Important

*All information is subject to change without prior notice.*

# Power Management

Power management of personal computers (PCs) and monitors has the potential to save significant amounts of electricity as well as deliver environmental benefits.

To be energy efficient, turn off your display or set your PC to sleep mode after a period of user inactivity.

## ► Power Management in Windows 10

- [Power Options] in Windows OS allow you to control the power management features of your display, hard drive, and battery. Right-click [Start] , select [Control Panel] from the list and then click [System and Security].

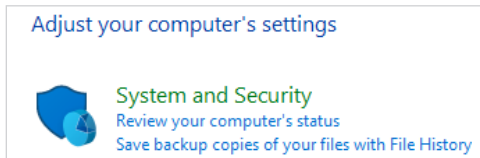

Select [Power Options] and choose a power plan that suits your personal needs. You may also fine-tune the settings by clicking [Change plan settings].

- The Shut Down Computer menu presents the options of Sleep (S3/S4) & Shut Down (S5) for rapid and easy management of your system power.

## ► Power Management through ENERGY STAR qualified monitors

The power management feature allows the computer to initiate a low-power or "Sleep" mode after a period of user inactivity. When used with an external ENERGY STAR qualified monitor, this feature also supports similar power management features of the monitor. To take advantage of these potential energy savings, the power management feature has been preset to behave in the following ways when the system is operating on AC power:

- Turn off the display after 10 minutes
- Initiate Sleep after 30 minutes



## ► Waking the System Up

The computer shall be able to wake up from power saving mode in response to a command from any of the following:

- the power button,
- the network (Wake On LAN),
- the mouse,
- the keyboard.



### Energy Saving Tips:

- Turn off the monitor by pressing the monitor power button after a period of user inactivity.
- Tune the settings in Power Options under Windows OS to optimize your PC's power management.
- Install power saving software to manage your PC's energy consumption.
- Always disconnect the AC power cord or switch the wall socket off if your PC would be left unused for a certain time to achieve zero energy consumption.

# Network Connection (Windows 10)

## ► Wired Network

1. Right-click [Start]  and select [Network Connections] from the list.
2. Select [Ethernet] and then [Network and Sharing Center].

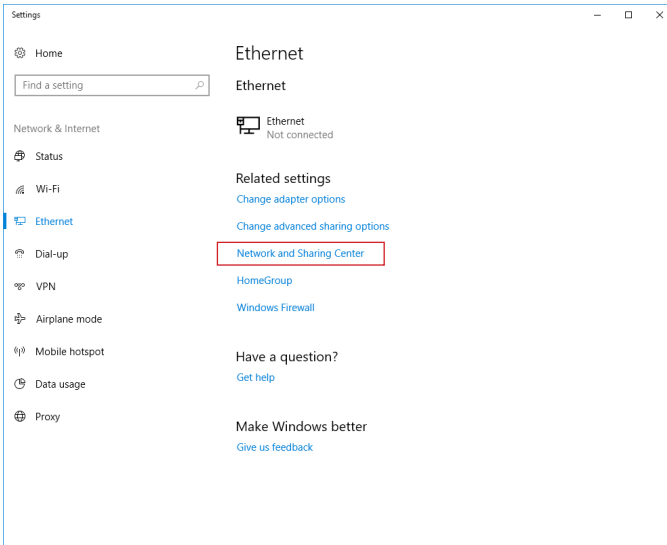

3. Select [Set up a new connection or network].

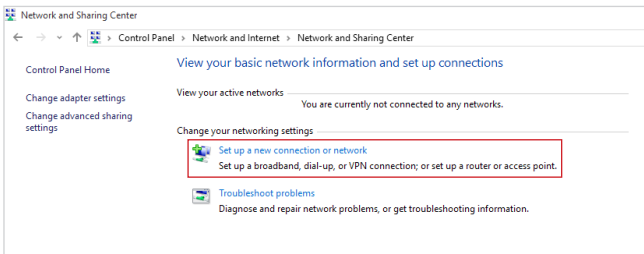

4. Choose [Connect to the Internet] and click [Next].
5. Select [Broadband (PPPoE)] to connect using DSL or cable that requires a user name and password.

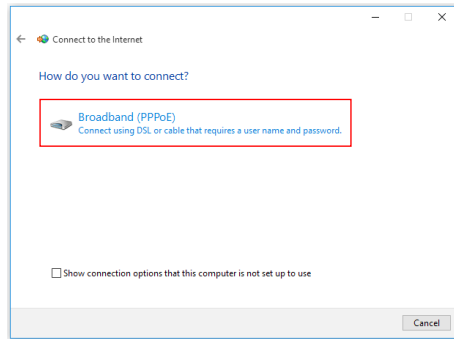

6. Type the information from your Internet Service Provider (ISP) and click [Connect] to establish your LAN connection.

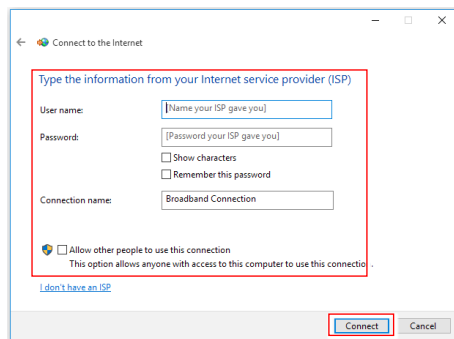

## ► Wireless Network

1. Go to [Start] , click [Settings] and select [Network and Internet].
2. A list of available WLAN connections pops up. Choose a connection from the list.
3. To establish a new connection, select [Network and Sharing Center].

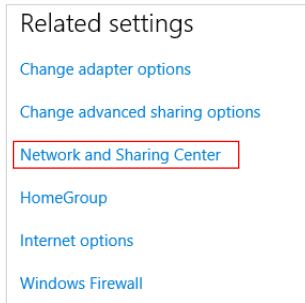

3-6

4. Select [Set up a new connection or network].
5. Followingly, choose [Manually connect to a wireless network] and click [Next] to continue.
6. Enter information for the wireless network you intend to add and click [Next] to proceed.

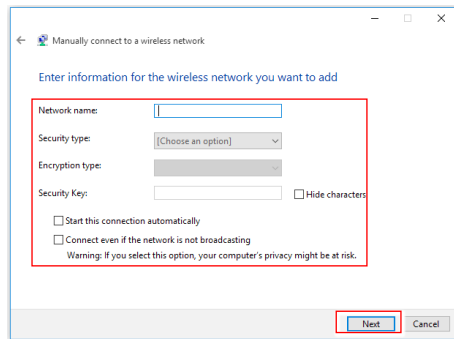

7. A new WLAN connection has been made.

## System Recovery (Windows 10)

The purposes for using the System Recovery Function may include:

- Restore the system back to the initial status of original manufacturer's default settings.
- When some errors have occurred to the operating system in use.
- When the operating system is affected by virus and is not able to work normally.
- When you want to install the OS with other built-in languages.

Before using the System Recovery Function, please back up the important data saved on your system drive to other storage devices.

If the following solution fails to recover your system, please contact the authorized local distributor or service center for further assistance.

# Reset this PC

1. Go to [Start] , click [Settings] and select [Update and security].
2. Select [Recovery] and click [Get started] under [Reset this PC] to start the system recovery.

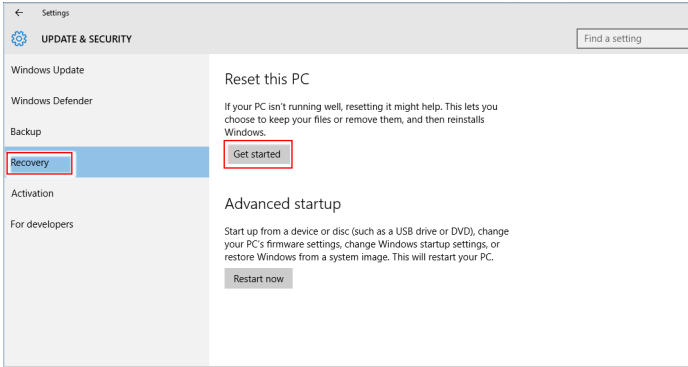

3-8

3. The [Choose an option] screen pops up. Choose between [Keep my files] and [Remove everything].

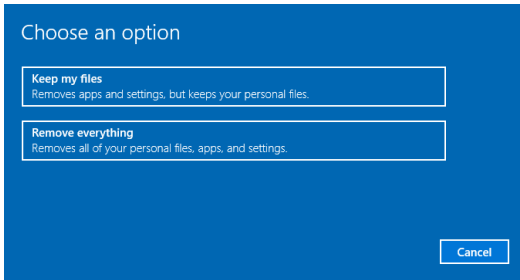

Reset this PC	Keep my files		
	Remove everything	Only the drive where Windows is installed	Just remove my files
		All drives	
			Remove files and clean the drive



## ► Keep my files

1. Select [Keep my files].

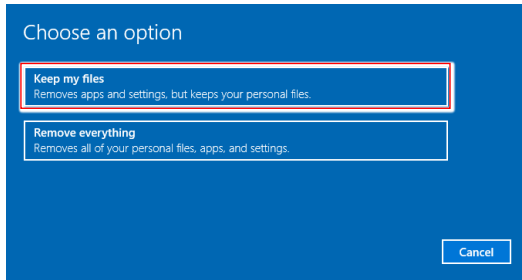

2. The [Your apps will be removed] screen shows a list of apps that will need to be reinstalled from the web or installation discs. Click [Next] to continue.

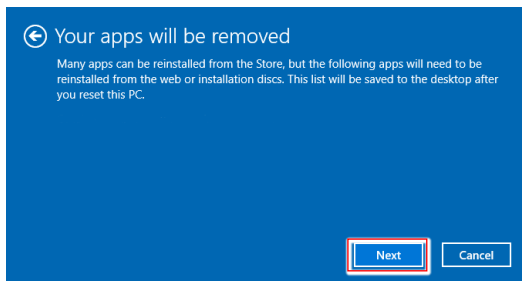

3. The next screen will show the changes to be made during the process. Click [Reset] to start the system reset.

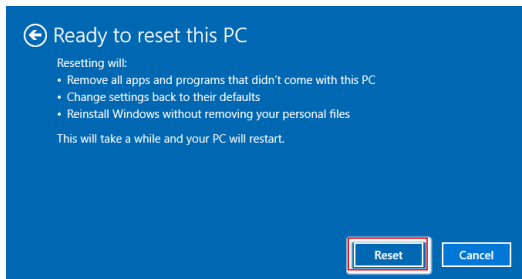

## ► Remove everything

1. Select [Remove everything].

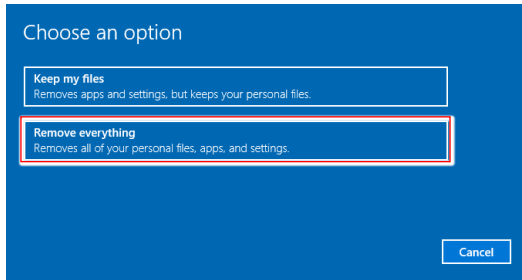

2. If you have multiple hard drives, a screen will pop up, asking you to choose between [Only the drive where Windows is installed] and [All drives].
3. Then select between [Just remove my files] and [Remove files and clean the drive].

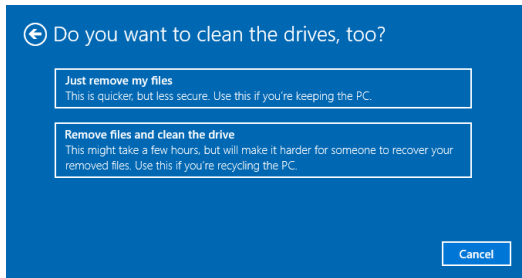

4. The next screen will show the changes to be made during the process. Click [Reset] to start the system reset.

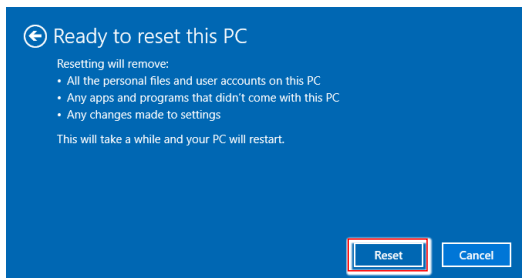

## System Recovery (F3 Hotkey Recovery)

### ► Precautions for Using the System Recovery Function

1. If your hard drive and system encountered non-recoverable problems, please use the F3 Hotkey recovery from the Hard Drive first to perform the System Recover Function.
2. Before using the System Recovery Function, please backup the important data saved on your system drive to other storage devices.

### ► Recovering the system with the F3 Hotkey

Follow the instructions below to continue:

1. Restart the PC.
2. Press the F3 hotkey on the keyboard promptly when the MSI greeting appears on the display.
3. On the “Choose an Option” screen, tap “Troubleshoot”.
4. On the “Troubleshoot” screen, tap “Restore MSI factory” to reset the system to the default settings.
5. On the “RECOVERY SYSTEM” screen, tap “System Partition Recovery”.
6. Follow the on-screen instructions to continue and complete the Recovery Function.

