

Counter

Assembly Instructions

Follow these instructions for the successful assembly of your Bouncepad Counter.

Sheet Code: BP-OR-IM-016_REV4
Release Date: 31/07/2018

Copyright 2017 Spotspot Ltd. (T/A Bouncepad) all rights reserved. Confidential, no part of this publication may be reproduced or transmitted in any form without the written permission of the copyright holder.

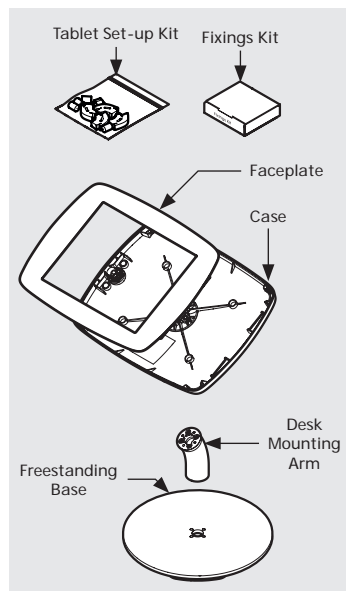

A Counter - In the Box

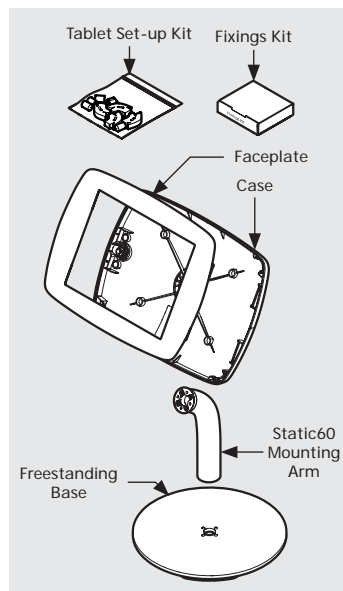

B Counter 60 - In the Box

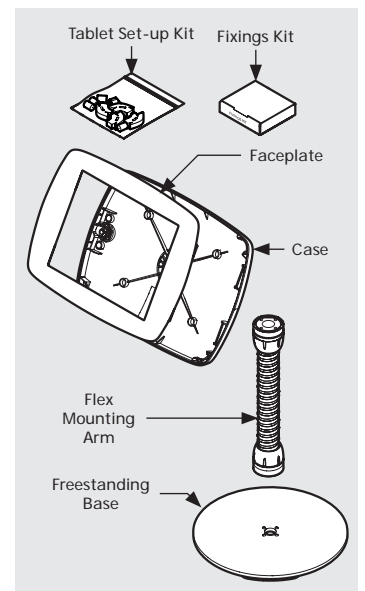

C Counter Flex - In the Box

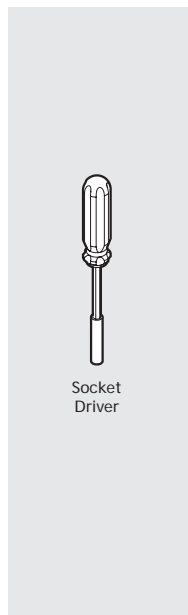

0 Tools Required

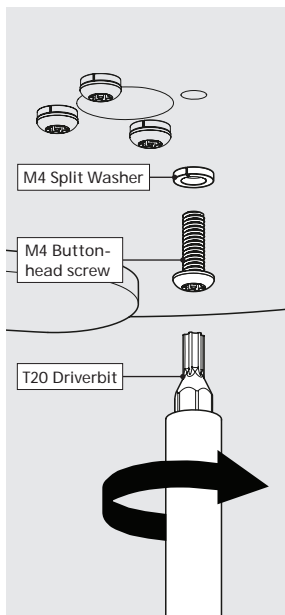

1 Attach your chosen Mounting Arm to the Freestanding Base. Ensure the correct fixings are used for your assembly.

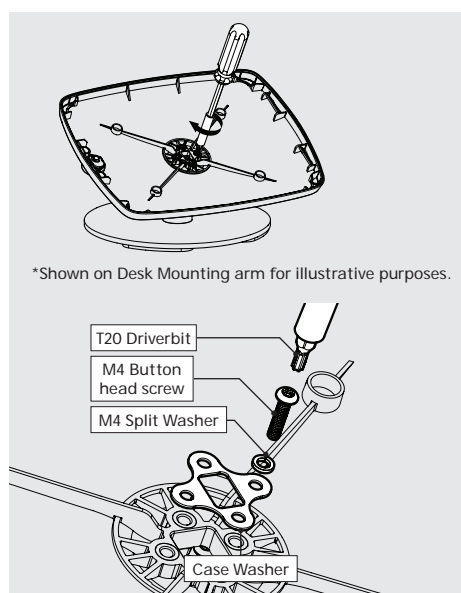
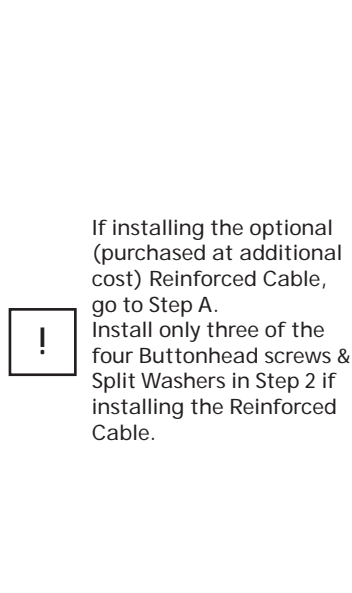
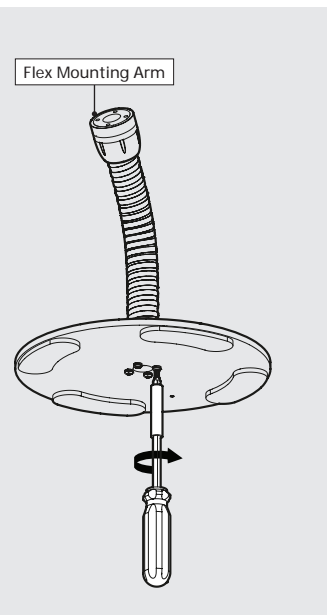
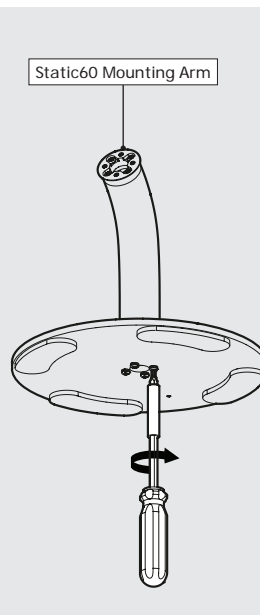
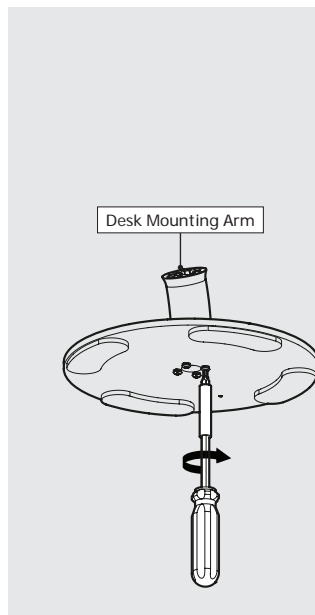

2 Attach the Bouncepad Case to its Mounting Arm. Take care to ensure correct & full thread engagement.

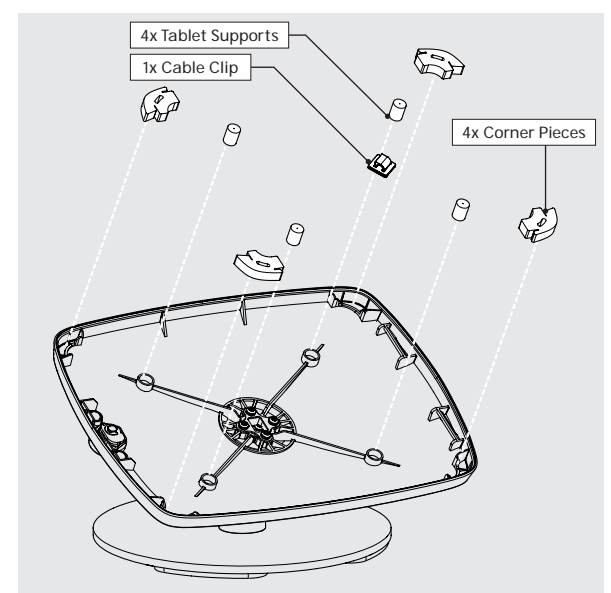

3 Install the Tablet Setup Kit. Each kit is specific per tablet device and Bouncepad Case.

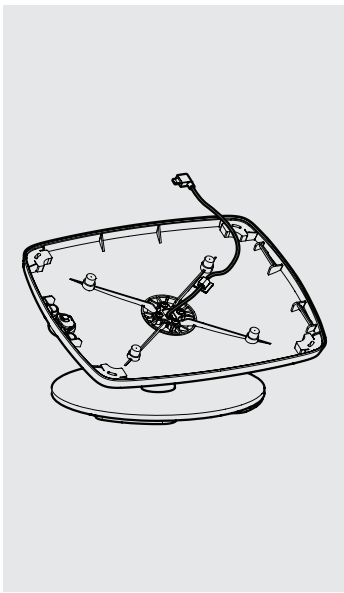

4 Feed the cable through the Case. Connect to its power supply.

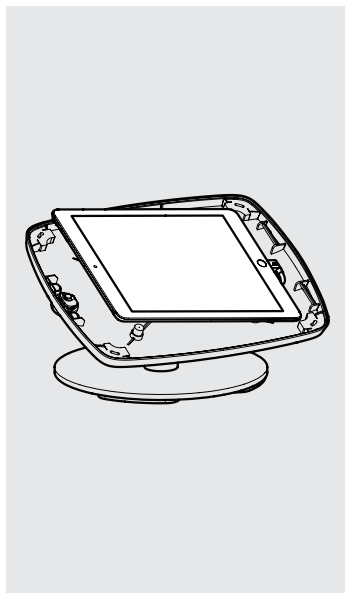

5 Install your Tablet into the Case - connecting its power supply cable.



6 Locate the Faceplate onto the Bouncepad Case.

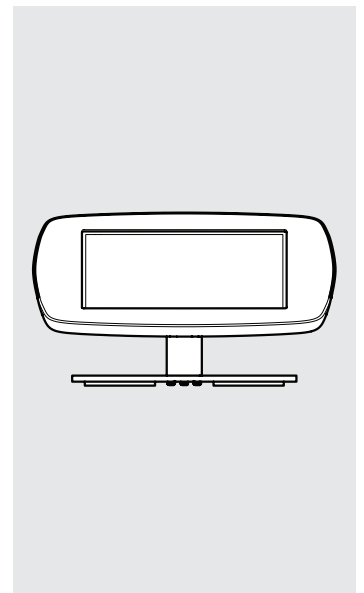

7 Lock the Faceplate to the Case. Installation complete.

bouncepad

Reinforced Cable

Assembly Instructions

Follow these instructions for the successful assembly of your Reinforced Cable.

*Reinforced Cable is sold (at additional cost) as an optional extra. Purchase of the Reinforced Cable negates the need for purchasing the Bouncepad Right Angle Cable.



A Reinforced Cable - In the Box

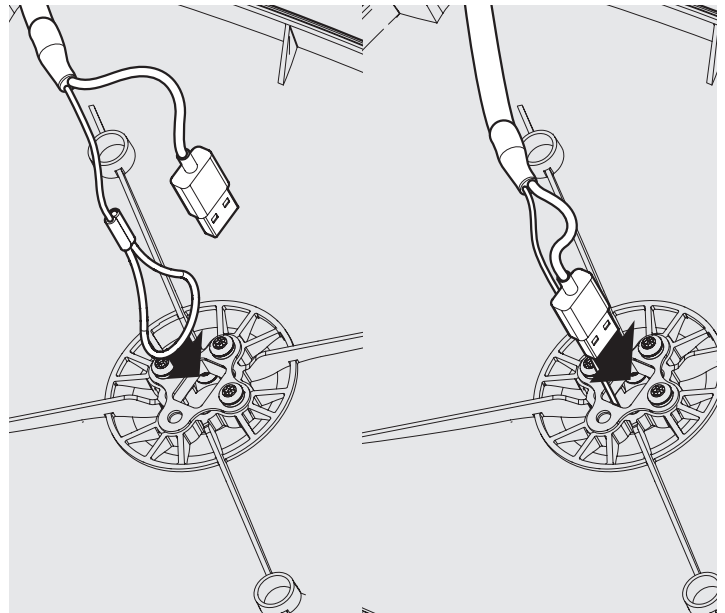

B Feed the looped end of the Reinforced Cable through the Case, Mounting Arm & Freestanding Base.



C Secure the Reinforced Cable to the Bouncepad Case with the remaining Spring Washer & Buttonhead screw.



D Secure the looped end of the Reinforced Cable. Must be secured next to the power socket used.

! Return to Step 3 to complete the installation of your Bouncepad.