

SPEAKER SYSTEM

CBR series

CBR15 CBR12 CBR10

Owner's Manual

English

Auf der Rückseite befindet sich die deutsche Version der Bedienungsanleitung.

In order to take full advantage of the CBR series* (referred to in this manual as CBR) superior functionality and enjoy years of trouble-free use, please read this manual before you begin using the product. After you have read the manual, keep it in a safe place for reference when needed.

- This manual uses example illustrations taken from the CBR12 if not otherwise specified.
- The illustrations as shown in this manual are for instructional purposes only.
- The company names and product names used in this manual are the trademarks or registered trademarks of their respective companies.

Features

- High-quality speaker unit, with smooth directional characteristics, and ports reducing wind roar in order to achieve High-resolution sound quality
- High sound pressure thanks to the unit's high-input tolerance and exceptional reliability from protection circuitry
- Highly portable light and compact cabinet
- Input connectors supporting both speakON and phone plugs
- Installable with eye bolt rigging and brackets

Included Accessories

- Technical Specifications (English only): includes specifications, block diagram, and dimensions.
- Owner's Manual (this leaflet)

PRECAUTIONS

PLEASE READ CAREFULLY BEFORE PROCEEDING

Please keep this manual in a safe place for future reference.

WARNING

Always follow the basic precautions listed below to avoid the possibility of serious injury or even death from electrical shock, short-circuiting, damages, or other hazards. These precautions include, but are not limited to, the following:

- Do not open**
 - This device contains no user-serviceable parts. Do not open the device or attempt to disassemble the internal parts or modify them in any way. If it should appear to be malfunctioning, discontinue use immediately and have it inspected by qualified Yamaha service personnel.

Fire warning

- Do not put burning items, such as candles, on the unit. A burning item may fall over and cause a fire.

CAUTION

Always follow the basic precautions listed below to avoid the possibility of physical injury to you or others, or damage to the device or other property. These precautions include, but are not limited to, the following:

- Location**
 - Do not place the device in an unstable position or fail to secure it properly in a potentially dangerous position where it may fall even if the position is horizontal. The device may accidentally fall over, resulting in damage and/or injury.
 - Do not use the speaker's handles for suspended installation. Doing so can result in damage or injury.
 - Do not hold the bottom of the device when transporting or moving it. In doing so, you may pinch your hands under the device, and result in injury.
 - Do not place the device in a location where it may come into contact with corrosive gases or salt air. Doing so may result in malfunction.
 - Before moving the device, remove all connected cables.
 - Always consult qualified Yamaha service personnel if the device installation requires construction work, and make sure to observe the following precautions.
 - Choose mounting hardware and an installation location that can support the weight of the device.
 - Avoid locations that are exposed to constant vibration.
 - Use the required tools to install the device.
 - Inspect the device periodically.

Connections

- Before connecting the device to other devices, turn off the power for all devices. Before turning the power on or off for all devices, set all volume levels to minimum.
- Use only speaker cables. Use of other types of cables may result in fire.
- Handling caution**
 - Do not insert your fingers or hands in any gaps or openings on the device.
 - Do not rest your weight on the device or place heavy objects on it, and avoid use excessive force on the buttons, switches or connectors.
 - Do not use the speakers for a long period of time at a high or uncomfortable volume level, since this can cause permanent hearing loss. If you experience any hearing loss or ringing in the ears, consult a physician.
 - Do not operate the device if the sound is distorting. Prolonged use in this condition could cause overheating and result in fire.

- When choosing a power amplifier for use with this device, make sure that the output power of the amplifier is lower than the power capacity of this device. If the output power is higher than the power capacity, malfunction or fire may occur.
- Do not input excessively loud signals that may result in clipping in the amplifier or cause the following:
 - Feedback, when using a microphone
 - Continuous and extremely loud sound from a musical instrument, etc.
 - Continuous and extremely loud distorted sound
 - Noise caused by plugging/unplugging the cable while the amplifier is turned on
- Even if the output power of the amplifier is lower than the power capacity of this device (program), damage to the device, malfunction or fire may occur.

Yamaha cannot be held responsible for damage caused by improper use or modifications to the device, or data that is lost or destroyed.

(PA-4)

NOTICE

To avoid the possibility of malfunction/damage to the product, damage to data, or damage to other property, follow the notices below.

Handling and Maintenance

- Do not expose the device to excessive dust or vibration, or extreme cold or heat (such as in direct sunlight, near a heater, or in a car during the day), in order to prevent the possibility of panel discoloration, unstable operation, or damage to the internal components.
- Do not place vinyl, plastic or rubber objects on the device, since this might discolor the panel.
- When cleaning the device, use a dry and soft cloth.
- Do not use paint thinners, solvents, cleaning fluids, or chemical-impregnated wiping cloths.
- Condensation can occur in the device due to rapid, drastic changes in ambient temperature—when the device is moved from one location to another, or air conditioning is turned on or off, for example. Using the device while condensation is present can cause damage. If there is reason to believe that condensation might have occurred, leave the device for several hours until the condensation has completely dried out.
- When turning on the AC power in your audio system, always turn on the power amplifier LAST, to avoid speaker damage. When turning the power off, the power amplifier should be turned off FIRST for the same reason.
- Be sure to observe the power amplifier's rated load impedance, particularly when connecting speakers in parallel. Connecting an impedance load outside the amplifier's rated range can damage the power amplifier.
- Protective Circuit**
 - All full-range loudspeakers are fitted with a self-resetting poly switch that protects the high-frequency driver from damage caused by excessive power. If a loudspeaker cabinet loses high-frequency output, immediately remove power from the power amplifier and wait for two to three minutes. This should be long enough to allow the poly switch to reset. Reapply power and check the performance of the high-frequency driver before continuing, with the power reduced to a level that does not cause the poly switch to interrupt the signal.
 - Air blowing out of the bass reflex ports is normal, and often occurs when the speaker is handling program material with heavy bass content.

Connectors

- Use only Neutrik speakON plugs (NL4) for connecting speakON connectors.

Controls and Connectors

Rear

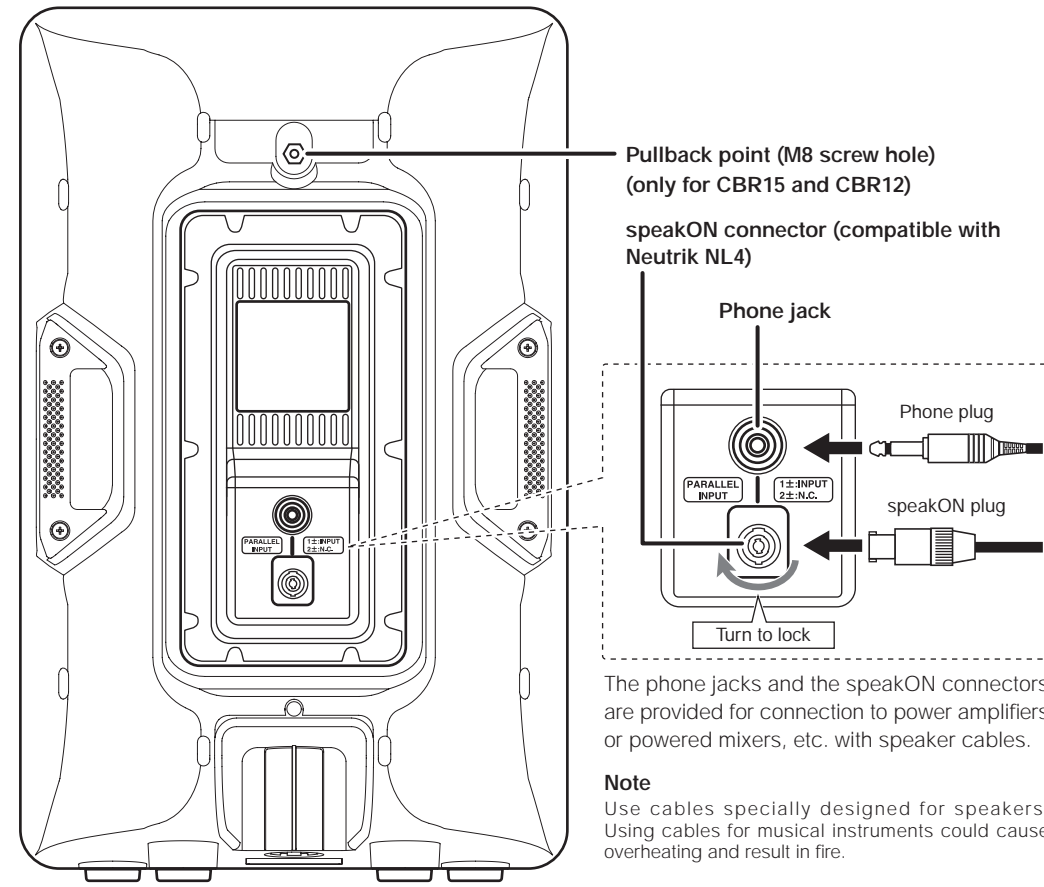

Bottom

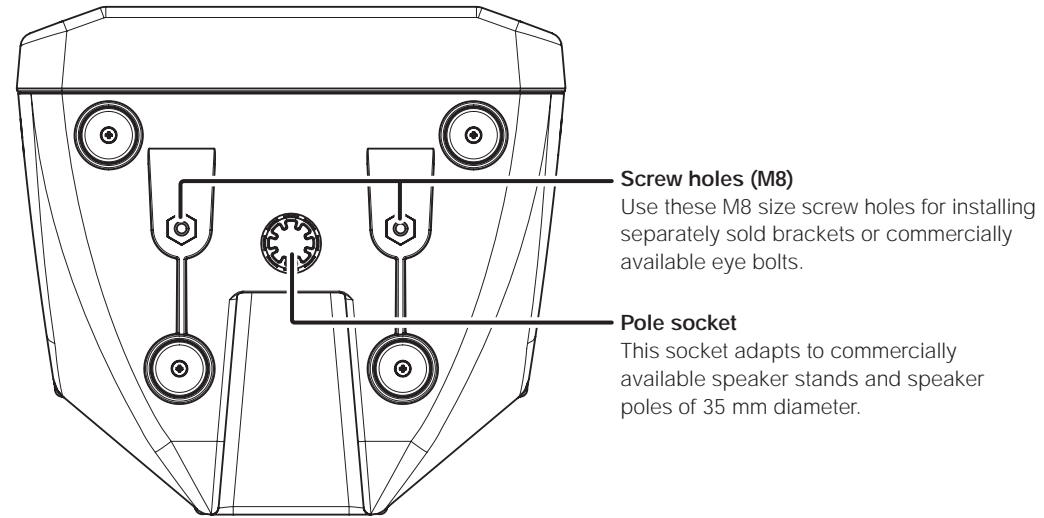

Connection

Wiring

Make sure to wire the plugs as shown below.

Phone plug

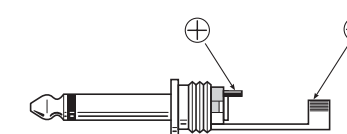

Neutrik speakON plug (NL4)

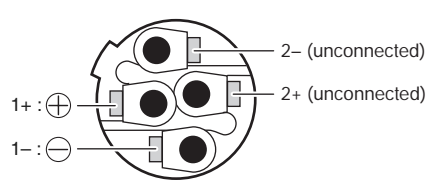

Parallel connection of speakers

The signals of the phone jack and speakON connector are connected in parallel. The first CBR receives the signal from an amplifier (such as a power amplifier, a powered mixer, etc.) with the phone jack or the speakON connector, and routes the signal to the second CBR. When connecting CBRs in parallel, be sure to check the load impedance the amplifier can drive. The nominal impedance of one CBR is eight ohms and the total impedance of two parallel connected CBRs is four ohms. In this case, the amplifier must be able to drive less than four ohm load impedance.

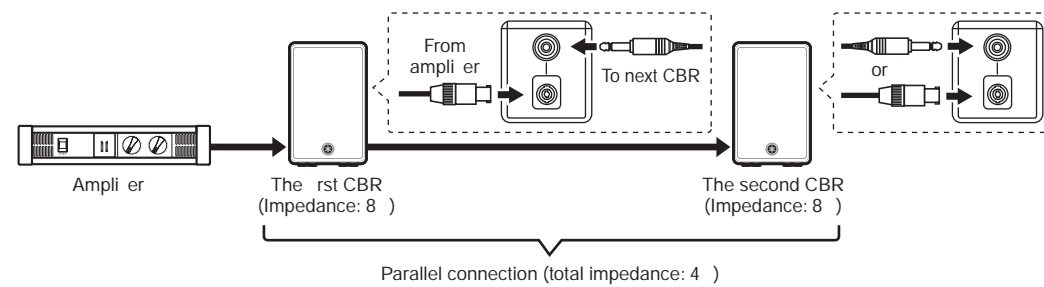

Invalid connection

Do not connect the input from the amplifier to both the phone jack and the speakON connector simultaneously. This creates a dangerous short circuit.

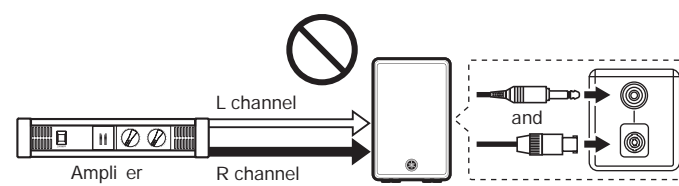

Installation Examples

CAUTION

- Before doing any installation or construction work, consult with your Yamaha dealer.
- For optimum safety, the installation should be checked thoroughly at regular intervals. Some fittings may deteriorate over extended periods of time due to wear and/or corrosion.
- When choosing the installation location, suspension wire and mounting hardware, make sure all are strong enough to support the weight of the speaker.
- Make sure to take measures to prevent the speaker from falling down in the event of an installation failure.
- When installing the safety wire to the wall, install it higher than the wire's attachment point on the speaker, with as little slack as possible. If the wire is too long, and the speaker happens to fall, the wire may snap as a result of too much strain.

Yamaha cannot be held responsible for damage or injury caused by insufficient strength of the support structure or improper installation.

Installation using separately sold Yamaha speaker brackets

Attach the bracket to two screw holes at the bottom of the unit using commercially available screws (M8 x 16 mm) or eye bolts (M8 x 15 mm). For details on installing the bracket, refer to the corresponding manual.

Using the BWS251-300 or BWS251-400 wall mounting bracket

The tilt angle depends on the position relation between the speaker and the wall. The maximum downward tilt angle is shown in the following chart.

Maximum tilt angle	BWS251-300	BWS251-400
CBR15	8°	17.5°
CBR12	11°	23°
CBR10	20°	35°

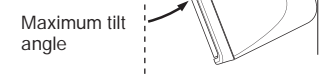

Using the BCS251 ceiling bracket

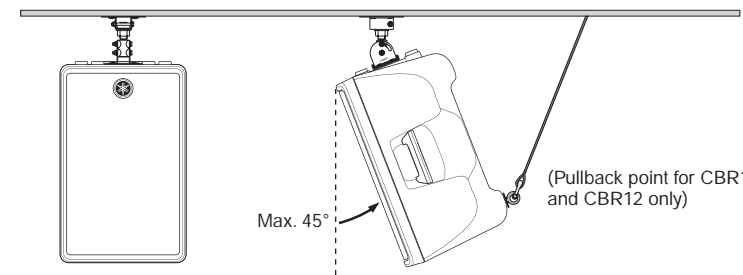

Using the BBS251 baton bracket

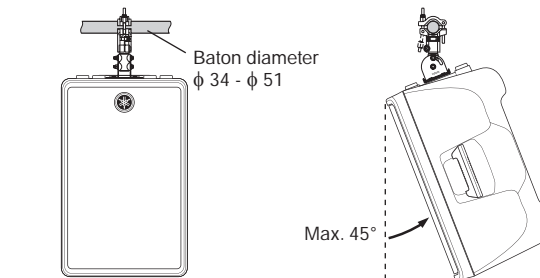

CAUTION

In order to prevent the unit from falling down, attach the safety wire as shown in the illustration.

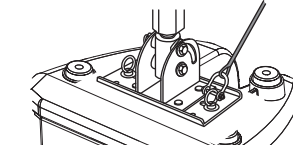

Troubleshooting

Symptom	Possible causes	Possible solution
No sound.	The cable is not connected properly.	<ul style="list-style-type: none"> Connect the cable all the way in so that it is firmly in place. If the speakON connector is used, connect to "1+" and "1-" and turn the plug to be locked.
Howling sound is produced (feedback).	<ul style="list-style-type: none"> A microphone is directed toward the speaker. The sound is amplified too much. 	<ul style="list-style-type: none"> Aim the speaker away from the area where the microphone picks up sound. Lower the volume of input device and locate the microphone more closely to the sound source.
The amplifier shuts down.	The total impedance of the speakers is less than the minimum load impedance of the amplifier. Example: More than two speakers (eight ohms) are connected to a power amplifier, the load impedance of which is six ohms.	Check the minimum load impedance of the power amplifier, and lower the number of speakers connected in parallel not to be less than the impedance.
High frequency range is attenuated.	The protection circuit is operating in the HF unit.	Refer to "Protection circuit" in the NOTICE.

If any specific problem should persist, however, please contact your Yamaha dealer.

Pullback point (only for CBR15 and CBR12)

- When the unit is shipped from the factory, a seal is stuck on the pullback point (screw hole). Make sure to peel off the seal when using the pullback point.
- The CBR10 does not have a pullback point.

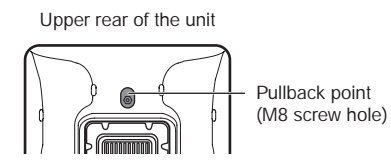

Securing the screws and eye bolts

- Insert the screw or eye bolt through the washer to attach them.

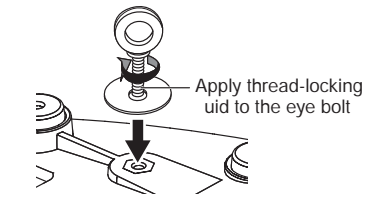

Installation using eye bolts

Attach commercially-available eye bolts (M8 x 15 mm) to the screw holes located at the bottom (two locations) and on the upper rear (one location, only for CBR15 and CBR12). Keep in mind that you will need two points at the bottom to suspend the unit.

CAUTION

Make sure to use eye bolts according to the standards and safety regulations in your area.

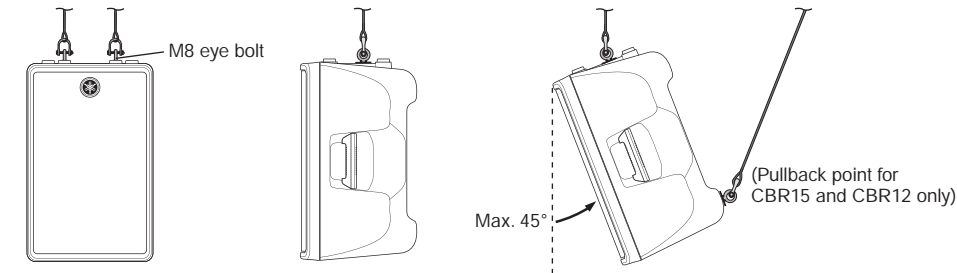

NOTICE

The strength of an eye bolt differs depending on the suspension angle. Make sure to use eye bolts within a range of 0 to 45 degrees from a right angle (as shown).

Correct: Within 45° from a right angle

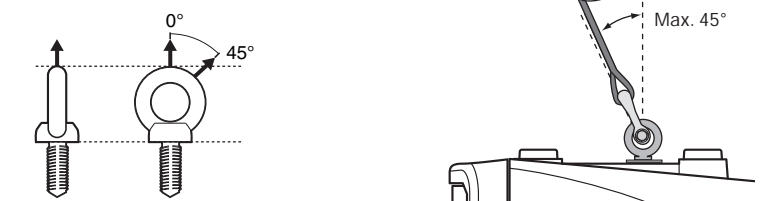

Incorrect: Do not suspend the eye bolts as shown in the illustrations below.

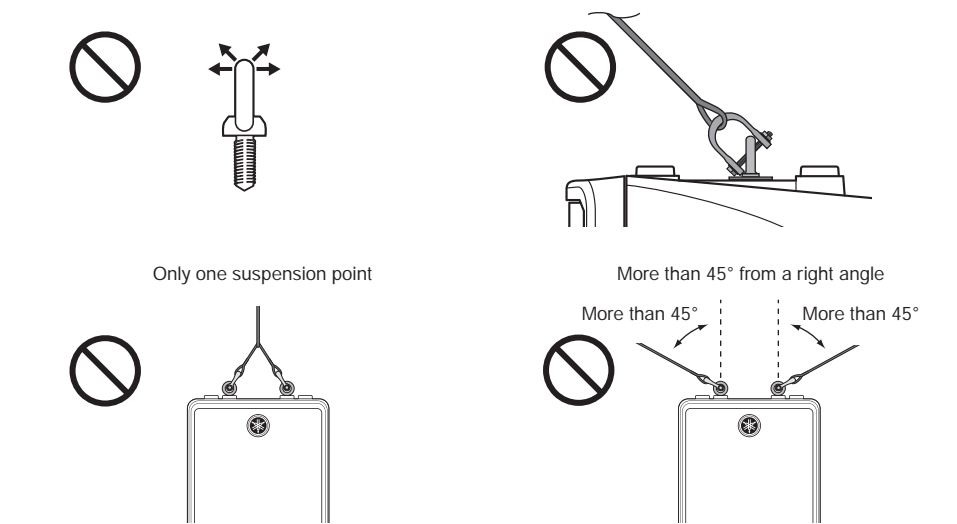

General Specifications

	CBR15	CBR12	CBR10
System Type	2-way Speaker, Bass-reflex Type		
Frequency Range (-10dB)	46 Hz-20 kHz	48 Hz-20 kHz	50 Hz-20 kHz
Coverage Angle (Horizontal x Vertical)	H90° x V60° Constant Directivity Horn		
Maximum SPL (Calculated, 1m)	126 dB SPL	125 dB SPL	123 dB SPL
Crossover Frequency	2.0 kHz	2.1 kHz	2.8 kHz
Nominal Impedance	8	8	8
Power Rating (IEC noise)	NOISE	250 W	175 W
	PGM	500 W	350 W
	MAX	1000 W	700 W
Sensitivity (1W, 1m)	LF	96 dB SPL	96 dB SPL
	HF	15" Cone, 2.5" Voice Coil	12" Cone, 2" Voice Coil
Components	LF	15" Cone, 2.5" Voice Coil	10" Cone, 2" Voice Coil
	HF	1.4" Voice Coil, Compression Driver	1" Voice Coil, Compression Driver
Dimensions (WxHxD, Including Rubber Feet)	455 x 700 x 378 mm (17.9" x 27.6" x 14.9")	376 x 601 x 348 mm (14.8" x 23.7" x 13.7")	308 x 493 x 289 mm (12.1" x 19.4" x 11.4")
Net Weight	17.7 kg (39.0 lbs)	13.9 kg (30.6 lbs)	9.4 kg (20.7 lbs)
Handles	Side x 2		Top x 1
Pole Socket	φ35 mm, Bottom x 1		
Rigging Points	Bottom x 2, Rear x 1 (Fit for M8 x 15 mm)		Bottom x 2 (Fit for M8 x 15 mm)
Optional Speaker Brackets	BBS251, BCS251, BWS251-300, BWS251-400		
Connectors	1/4" Phone x 1, speakON NL4MP x 1		

* The contents of this manual apply to the latest specifications as of the printing date. Since Yamaha makes continuous improvements to the product, this manual may not apply to the specifications of your particular product. To obtain the latest manual, access the Yamaha website then download the manual file. Since specifications, equipment or separately sold accessories may not be the same in every locale, please check with your Yamaha dealer.