

USER MANUAL

MODELS:

VS-211XS 2x1 4K Auto Switcher

VS-411XS 4x1 4K Auto Switcher



Contents

Introduction	1
Getting Started	1
Overview	2
Typical Applications	4
Defining VS-211XS and VS-411XS	5
VS-211XS / VS-411XS Front Panel	5
VS-211XS / VS-411XS Rear Panel	6
Mounting VS-211XS / VS-411XS	7
Connecting VS-411XS	8
Connecting Output to a Balanced/Unbalanced Stereo Audio Acceptor	9
Connecting to VS-411XS via RS-232	9
Principles of Operation	10
Input Auto-Switching	10
IP-Driven CEC Signals Routing via Built-in Control Gateway	11
Maestro Built-in Control and Automation Configuration	12
Maestro Kramer Aware Touch Panel Control	14
Operating and Controlling VS-411XS	15
Using Front Panel Buttons	15
Setting DIP-Switches	15
Using Contact Closure Remote Control Pins	16
Acquiring and Discovering Plug-and-Play IP Address	17
Operating via Ethernet	18
Using Embedded Web Pages	22
Selecting an Input	23
Adjusting Audio Output Volume	24
Viewing and Adjusting General Settings	24
Setting Remote Buttons	25
Loading and Saving Settings	25
Resetting Device	26
Defining IP Settings	27
Define CEC Gateway Settings	29
Setting Time and Date	30
Upgrading the Firmware	31
Setting Security	32
Setting Auto Switching Priorities	34
Setting Input Color Depth	34
Setting Output Audio Source for De-embedded Audio	35
Setting HDCP Support	35
Setting Video Signal Timeouts	37
Managing EDID	38
Configuring Device Control and Automation	41
Operating via Maestro Kramer Aware Touch Panel	45
Viewing About Page	59
Firmware Upgrade	60
Technical Specifications	61
Default Communication Parameters	62
Default Automation settings	62
Default EDID	66
Protocol 3000	69
Understanding Protocol 3000	69
Protocol 3000 Commands	70
Result and Error Codes	81

Introduction

Welcome to Kramer Electronics! Since 1981, Kramer Electronics has been providing a world of unique, creative, and affordable solutions to the vast range of problems that confront the video, audio, presentation, and broadcasting professional on a daily basis. In recent years, we have redesigned and upgraded most of our line, making the best even better!

-  This user manual describes **VS-211XS** and **VS-411XS**. These devices are identical except for the number of their inputs. Note that whenever **VS-411XS** is used in the user manual, it also refers to **VS-211XS**, unless specified otherwise. (A device is named specifically only when a device-specific feature is described).

Getting Started

We recommend that you:

- Unpack the equipment carefully and save the original box and packaging materials for possible future shipment.
- Review the contents of this user manual.

-  Go to www.kramerav.com/downloads/VS-211XS or www.kramerav.com/downloads/VS-411XS to check for up-to-date user manuals, application programs, and to check if firmware upgrades are available (where appropriate).

Achieving Best Performance

- Use only good quality connection cables (we recommend Kramer high-performance, high-resolution cables) to avoid interference, deterioration in signal quality due to poor matching, and elevated noise levels (often associated with low quality cables).
- Do not secure the cables in tight bundles or roll the slack into tight coils.
- Avoid interference from neighboring electrical appliances that may adversely influence signal quality.
- Position your Kramer **VS-411XS** away from moisture, excessive sunlight and dust.

Safety Instructions



Caution:

- This equipment is to be used only inside a building. It may only be connected to other equipment that is installed inside a building.
- For products with relay terminals and GPIO ports, please refer to the permitted rating for an external connection, located next to the terminal or in the User Manual.
- There are no operator serviceable parts inside the unit.



Warning:

- Use only the power cord that is supplied with the unit.
- To ensure continuous risk protection, replace fuses only according to the rating specified on the product label which is located on the bottom of the unit.

Recycling Kramer Products

The Waste Electrical and Electronic Equipment (WEEE) Directive 2002/96/EC aims to reduce the amount of WEEE sent for disposal to landfill or incineration by requiring it to be collected and recycled. To comply with the WEEE Directive, Kramer Electronics has made arrangements with the European Advanced Recycling Network (EARN) and will cover any costs of treatment, recycling and recovery of waste Kramer Electronics branded equipment on arrival at the EARN facility. For details of Kramer's recycling arrangements in your particular country go to our recycling pages at www.kramerav.com/support/recycling.

Overview

VS-211XS and **VS-411XS** are intelligent (2x1 and 4x1, respectively) automatic switchers for 4K HDR, HDMI™ video signals. **VS-411XS** offers an intelligent switching experience with built-in Maestro room control and the standard priority / last-connected switching function based on active video signal detection.

VS-411XS provides exceptional quality, advanced and user-friendly operation, and flexible control.

Exceptional Quality

- Plug & Play Auto Switcher – Automatically plays the switched source signal on the connected display according to user-configured preferences, such as priority or last-connected input. When the user manually switches, by pressing a button, the auto switching is overridden.
- I-EDIDPro™ Kramer Intelligent EDID Processing™ – Intelligent EDID handling, processing, locking and pass-through algorithm ensures plug & play operation for HDMI source and display systems.
- HDMI Signal Switching – HDCP 2.2 compliant, Supporting deep color, x.v.Color™, CEC, lip sync, HDMI uncompressed audio channels, Dolby TrueHD, DTS–HD, 2K, 4K, and 3D as specified in HDMI 2.0.
- Multi-channel Audio Switching – Up to 32 channels of digital stereo uncompressed signals for supporting studio-grade surround sound.

Advanced and User-friendly Operation

- Simple and Powerful Maestro Room Control – Out-of-the-box configured room control for a typical meeting room setup, and intuitive user interface enables you to fully control your meeting room elements. Room devices are controlled right out-of-the-box by an extensive range of triggers, including input/output connectivity, routing, and button pressing. By minimizing user intervention, Maestro room control saves meeting prep time and minimizes human error before presentations.
- Easy Remote Device Control – Control meeting and presentation devices connected to **VS-411XS** from the user-friendly Kramer Aware app on a compatible Kramer touch panel (sold separately). Kramer Aware includes a built-in, basic user-interface panel, pre-configured for Maestro-controlled typical meeting room setup.
- Simple Manual Switching Operation – Local panel buttons, or remotely connected contact-closure buttons, and optional Maestro Kramer Aware touch panel buttons, for flexible user input selection and switching control.
- Audio De-embedding – The digital audio signal passing-through to the HDMI output, is de-embedded, converted to an analog signal and sent to the stereo balanced analog audio output. This enables playing the audio on a locally connected professional audio system (such as DSP) and speakers, in parallel to playing it on the speakers connected to the AV acceptor device (such as TVs with speakers).
- Automatic Display Operation – Part of the out-of-the-box Maestro configured room automation. Meeting presentation is simplified by automatically turning ON/OFF a CEC-enabled display when the presentation source is plugged in / unplugged with user-defined shut-down delay.
- Easy Audio Control – Adjust the audio output volume or mute via front panel buttons, built-in Maestro and Kramer Aware touch panel buttons, embedded web pages control buttons, and remote IP or local RS-232 serial commands.
- IP-Based Firmware Upgrade – Ethernet-based, via a user-friendly software upgrade tool or via embedded web pages, enabling upgrade via Kramer Network management.
- Cost-effective Maintenance – Status LED indicators for HDMI ports facilitate easy local maintenance and troubleshooting. Remote IP-driven device management, and optional whole site management system, via built in web pages and RS-232 connection. Local and remote firmware upgrade via RS-232 or Ethernet connection tool ensure lasting, field proven deployment.
- Easy Installation – Compact DemiTOOLS® fan-less enclosure for user-reachable table mounting, or side-by-side mounting of 2 units in a 1U rack space with the recommended rack adapter.

Flexible Connectivity

- Comprehensive Unit Control and Configuration Options – Local control via DIP-switches, volume and mute buttons, and volume and mute contact closure switches. Distance control via user-friendly embedded web pages via the Ethernet, Protocol 3000 API commands via RS-232 serial communication transmitted by a PC, touch screen system or other serial controller.

Typical Applications

VS-411XS is ideal for the following typical applications:

- Corporate or educational AV meeting solution, where an intelligent, high-quality auto switcher is needed.
- Smart controllable switching in small to medium size meeting and training rooms.

Controlling your **VS-411XS**

Control your **VS-411XS** directly via the front panel push buttons, or:

- Via the Ethernet using built-in user-friendly web pages.
- Via optional Kramer Aware touch panel.
- By RS-232 serial commands transmitted by a touch screen system, PC, or other serial controller.
- Via REMOTE dry contact pins.

Defining VS-211XS and VS-411XS

This section defines VS-211XS and VS-411XS front and rear panels.

VS-211XS / VS-411XS Front Panel

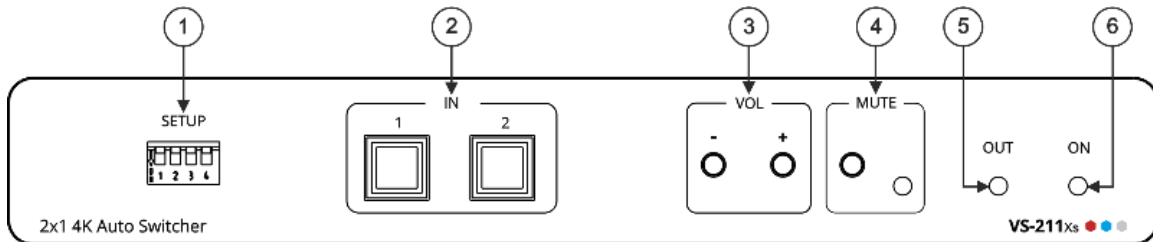

Figure 1: VS-211XS 2x1 4K Auto Switcher Front Panel

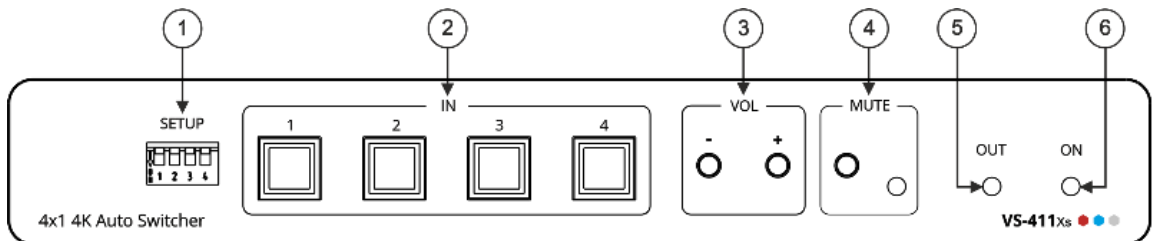

Figure 2: VS-411XS 4x1 4K Auto Switcher Front Panel

#	Feature	Function	
①	SETUP 4-way DIP-Switches	Set the operation DIP-switches (see Setting DIP-Switches on page 15).	
②	IN Buttons	Press to select an HDMI input (button lights orange): VS-211XS: IN 1 and IN 2. VS-411XS: IN 1 to IN 4.	
③	VOL Push Buttons	-	Press to decrease audio output volume.
		+	Press to increase audio output volume.
④	MUTE	Push Button	Press to mute the audio output. The audio signal remains mute when using the VOL – button and unmutes automatically when pressing the VOL + button.
		LED	Lights red when audio output is muted.
⑤	OUT LED	Lights green when an HDMI output is connected.	
⑥	ON LED	Lights green when the device receives power.	

VS-211XS / VS-411XS Rear Panel

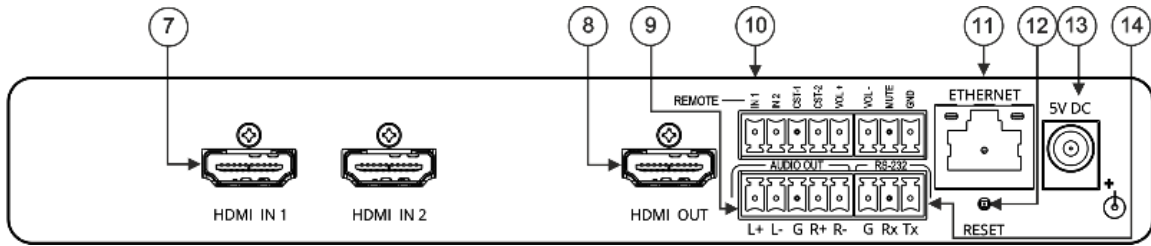

Figure 3: VS-211XS 2x1 4K Auto Switcher Rear Panel

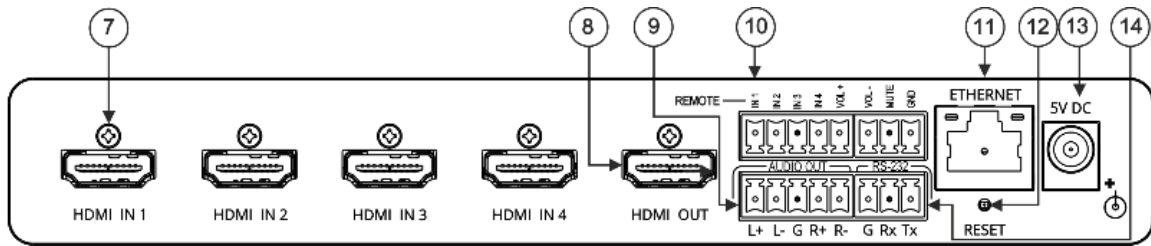

Figure 4: VS-411XS 4x1 4K Auto Switcher Rear Panel

#	Feature	Function
7	HDMI IN Connectors	Connect to an HDMI source: VS-211XS: HDMI IN 1 and HDMI IN 2. VS-411XS: HDMI IN 1 to HDMI IN 4.
8	HDMI OUT Connector	Connect to an HDMI acceptor.
9	AUDIO OUT 5-pin Terminal Block Connector	Connect to a balanced stereo audio acceptor.
10	REMOTE Terminal block Connector:	Connect to contact closure switches by momentary contact between the desired pin and common GND pin (see Using Contact Closure Remote Control Pins on page 16).
	For VS-211XS: IN 1, IN 2/ CST-1, CST-2	Select input 1 or input 2 (IN 1 or IN 2), or alternatively activate custom triggers (including CST-1 and CST-2 to GND) set up in Maestro. (Configured via the embedded web pages).
	For VS-411XS: IN 1, IN 2, IN 3, IN 4	Select input 1 to input 4 (IN 1 to IN 4), or alternatively activate custom triggers set up in Maestro. (Configured via the embedded web pages).
	VOL+, VOL -, MUTE	Set the volume up or down (VOL+/-) and mute the audio output (MUTE).
11	ETHERNET RJ-45 Connector	Connect to a PC via a LAN to control the device.
12	RESET Recessed Button	Press briefly to restart the device. Press and hold (5 seconds) to fully reset the device parameters to their default values, including ETH parameters.
13	5V DC Power Connector	Connect to the power supply and to the mains electricity.
14	RS-232 3-pin Terminal Block Connector	Connect to a PC or a remote controller to control the device.

Mounting VS-211XS / VS-411XS

This section provides instructions for mounting **VS-211XS**. Before installing, verify that the environment is within the recommended range:



- Operation temperature – 0° to 40°C (32 to 104°F).
- Storage temperature – -40° to +70°C (-40 to +158°F).
- Humidity – 10% to 90%, RHL non-condensing.



Caution:

- Mount **VS-211XS / VS-411XS** before connecting any cables or power.



Warning:

- Ensure that the environment (e.g., maximum ambient temperature & air flow) is compatible for the device.
- Avoid uneven mechanical loading.
- Appropriate consideration of equipment nameplate ratings should be used for avoiding overloading of the circuits.
- Reliable earthing of rack-mounted equipment should be maintained.
- Maximum mounting height for the device is 2 meters.

Mount VS-211XS / VS-411XS in a rack:

- Use the recommended rack adapter
(see www.kramerav.com/product/VS-211XS / www.kramerav.com/product/VS-411XS).

Mount VS-211XS / VS-411XS on a surface using one of the following methods:

- Attach the rubber feet and place the unit on a flat surface.
- Fasten a bracket (included) on each side of the unit and attach it to a flat surface. For more information go to www.kramerav.com/downloads/VS-211XS / www.kramerav.com/downloads/VS-411XS.

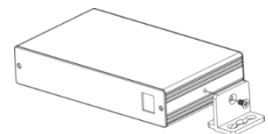

Connecting VS-411XS

i Since the main difference between VS-211XS and VS-411XS are the number of inputs, from this section on, any description of VS-411XS applies also to VS-211XS, unless stated otherwise.

i Always switch off the power to each device before connecting it to your VS-411XS. After connecting your VS-411XS, connect its power and then switch on the power to each device.

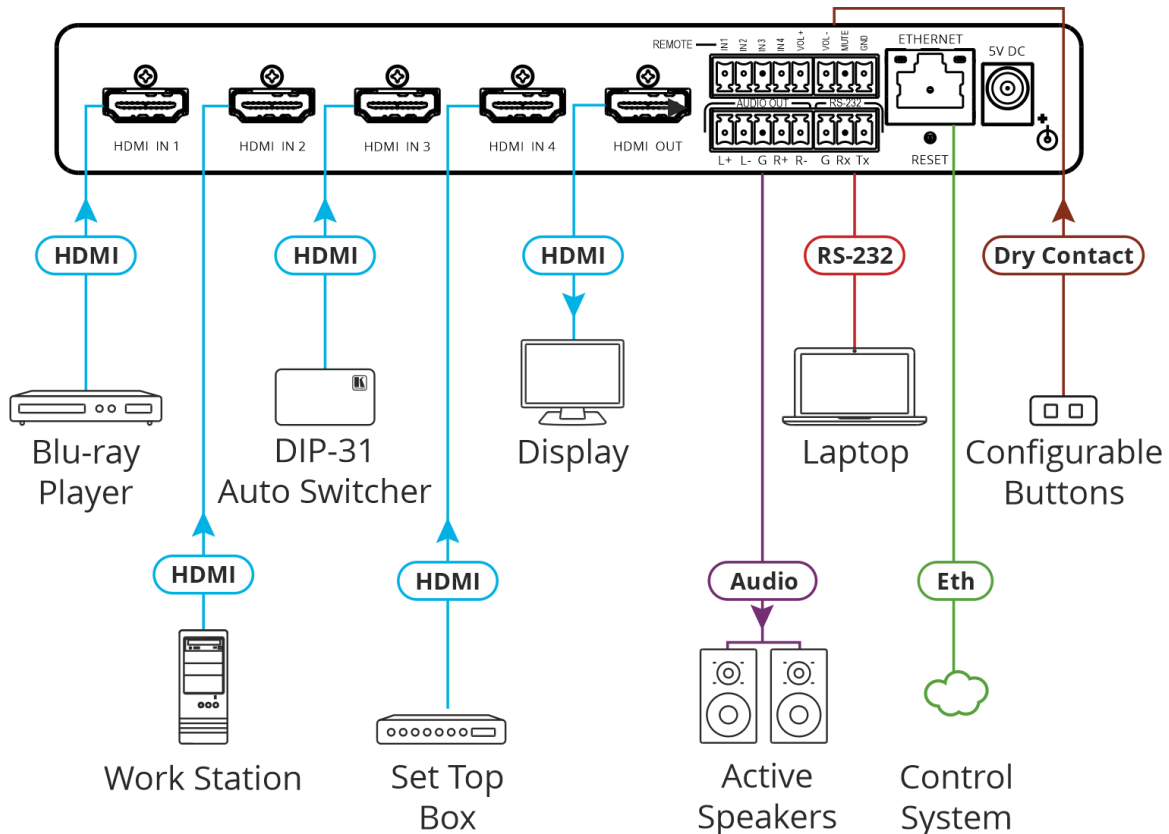

Figure 5: Connecting to the VS-411XS Rear Panel

To connect VS-411XS as illustrated in the example in [Figure 5](#):

- Connect an HDMI source to the HDMI IN connectors (7), for example, Connect:
 - A Blu-ray player to HDMI IN 1.
 - A work Station to HDMI IN 2.
 - Kramer **DIP-31** Auto Switcher to HDMI IN 3.
 - A Set top box to HDMI IN 4.
- Connect HDMI OUT (8) to an HDMI acceptor (for example, a display).
- Connect AUDIO OUT to a balanced stereo audio acceptor (for example, Kramer **Tavor 5-O** active speakers).
- Connect REMOTE dry-contact terminal block connectors (10) to configurable buttons to select an input (see [Using Contact Closure Remote Control Pins](#) on page 16) or activate a custom Maestro trigger (see [Configuring Device Control and Automation](#) on page 41).

5. Connect the RS-232 3-pin terminal block connector (14) to the RS-232 port on a controller (for example, a laptop) to control the **VS-411XS**.
6. Connect the ETHERNET RJ-45 port (11) to the LAN.
7. Connect the 5V power adapter to **VS-411XS** and to the mains electricity (not shown in [Figure 5](#)).

Connecting Output to a Balanced/Unbalanced Stereo Audio Acceptor

The following are the pinouts for connecting the output to a balanced or unbalanced stereo audio acceptor:

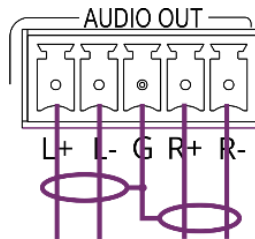

Figure 6: Connecting to a Balanced Stereo Audio Acceptor

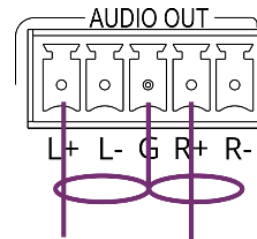

Figure 7: Connecting to an Unbalanced Stereo Audio Acceptor

Connecting to VS-411XS via RS-232

You can connect to **VS-411XS** via an RS-232 connection (14) using, for example, a PC.

VS-411XS features an RS-232 3-pin terminal block connector allowing the RS-232 to control **VS-411XS**.

Connect the RS-232 terminal block on the rear panel of **VS-411XS** to a PC/controller, as follows:

From the RS-232 9-pin D-sub serial port connect:

- Pin 2 to the TX pin on the **VS-411XS** RS-232 terminal block.
- Pin 3 to the RX pin on the **VS-411XS** RS-232 terminal block.
- Pin 5 to the G pin on the **VS-411XS** RS-232 terminal block.

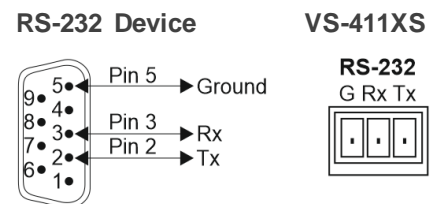

Principles of Operation

This section describes the **VS-411XS** powerful operation principles:

- [Input Auto-Switching](#) on page [10](#).
- [IP-Driven CEC Signals Routing via Built-in Control Gateway](#) on page [11](#).
- [Maestro Built-in Control and Automation](#) Configuration on page [12](#).
- [Maestro Kramer Aware Touch Panel](#) Control on page [14](#).

Input Auto-Switching

Input selection is set by the DIP-switches (see [Setting DIP-Switches](#) on page [15](#)) to either of the following modes:

- Manual
- Auto – Last connected
- Auto – Priority

By-default switching is set to Auto Last connected.



When in manual mode, a manual switch to an unconnected input stays connected to output. Manual switching overrides auto-switch mode.

In manual mode, select an input by:

- Pressing input front panel buttons.
- Using remote input selection switches (see [Using Contact Closure Remote Control Pins](#) on page [16](#)).
- Sending RS-232 serial commands control (see [Protocol 3000 Commands](#) on page [70](#)).
- Using the embedded web pages (see [Selecting an Input](#) on page [23](#)).
- Using Maestro Control on Kramer Aware touch panel (see [Operating via Maestro Kramer Aware Touch Panel](#) on page [45](#)).

In auto-switching mode, switching selection is performed based on either last connected or priority input:

- In last connected mode, if the signal on the current input is lost, **VS-411XS** automatically selects the last connected input, (the delay depends on a configurable timeout).
- In priority mode, when the input sync signal is lost for any reason, the input with a live signal and next in priority is selected automatically, (the delay depending on the configurable signal-lost timeout, (see [Setting Auto Switching Priorities](#) on page [34](#)).

IP-Driven CEC Signals Routing via Built-in Control Gateway

VS-411XS sends CEC commands from a control system, connected by LAN, via the VS-411XS built-in control gateway, to control devices that are connected to the VS-411XS HDMI output and the selected input.

The built-in control gateway sends the control commands to the connected controlled devices, and sends their received responses to the control system when DIP-switch 3 is enabled (see [Setting DIP-Switches](#) on page 15).

[Figure 8](#) shows the VS-411XS built-in control gateway connection. A control system supporting CEC-over-IP (such as Kramer Control) is connected to the Ethernet port via LAN. The control system sends CEC commands to the selected input (IN 1, in this example) and the output, and receives responses from them.

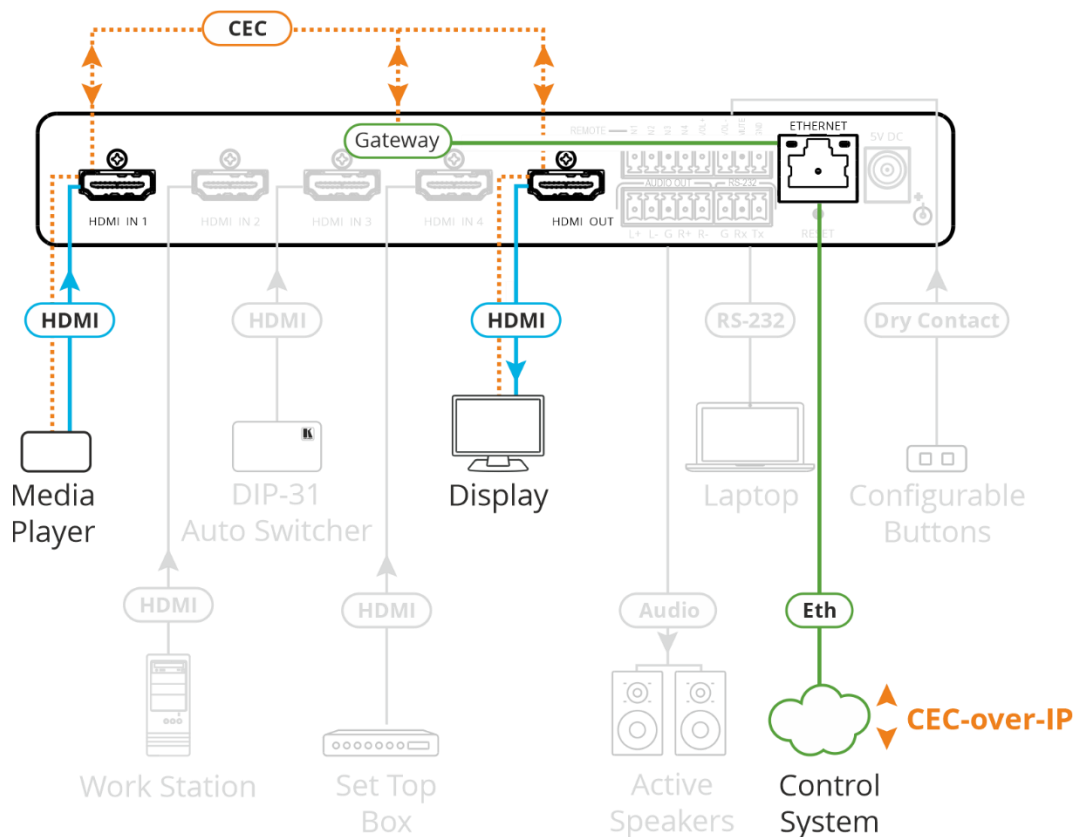

Figure 8: CEC Signals via Control Gateway

Built-in CEC gateway ON/OFF configuration and management (such as the CEC members logical addresses view) is performed via web-UI (see [Define CEC Gateway Settings](#) on page 29) and DIP-switches (see [Setting DIP-Switches](#) on page 15) for CEC notification settings.

Maestro Built-in Control and Automation Configuration

The **VS-411XS** built-in Maestro control and automation enables configuring triggers to simply create a sequence of actions that are carried out following trigger activation (see [Configuring Device Control](#) and Automation on page 41).

Thanks to out-of-the-box default configuration, **VS-411XS** is ready to control the following typical room configuration that can be controlled via several Maestro triggers.

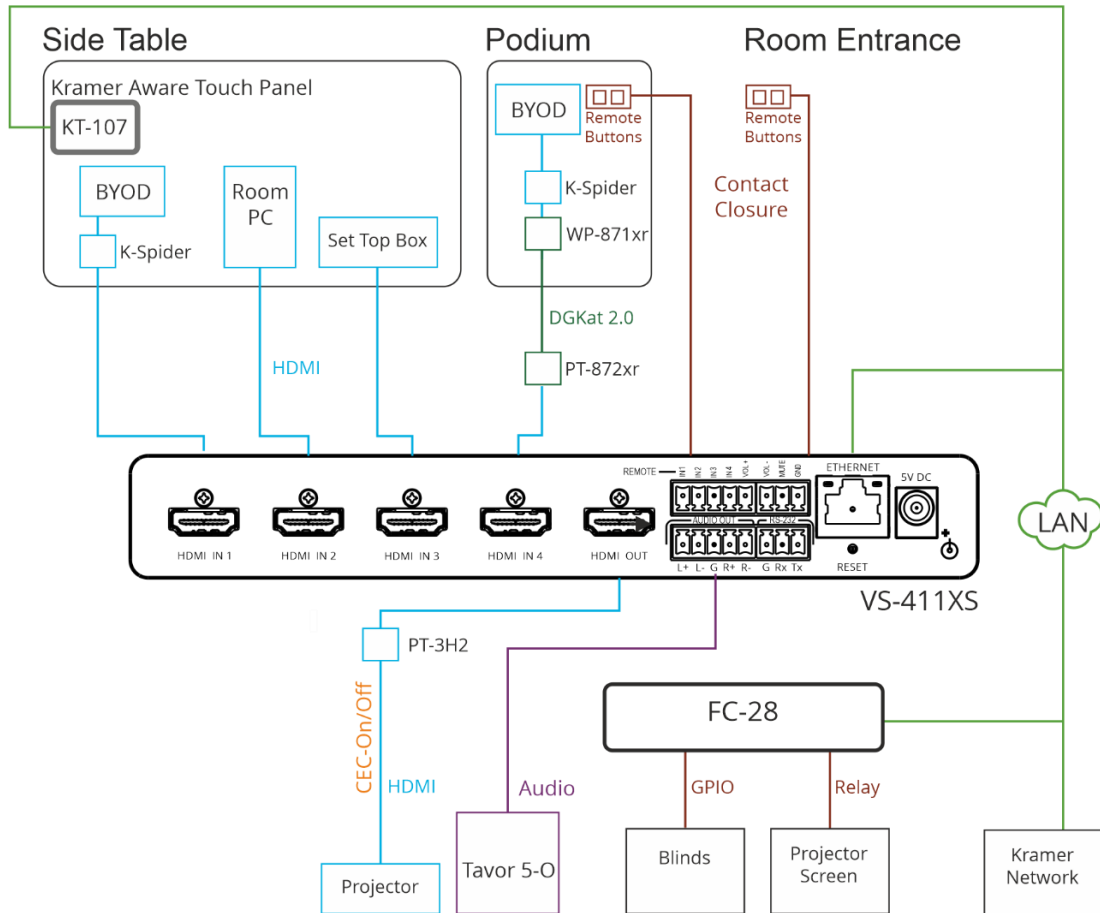

Figure 9: Typical Room Configuration

This room includes a podium, a side table, a projector, speakers, a projector screen, room blinds and so on, as follows:

On the side table:	<ul style="list-style-type: none"> • Three sources connected to VS-411XS HDMI inputs (for example, the Room PC, or a plugged-in device to connect to the K-Spider adapter cable). • A KT-107 touch panel supporting Kramer aware and connected to the LAN.
<ul style="list-style-type: none"> • Under the side table: 	<ul style="list-style-type: none"> • VS-411XS and FC-28 IP control gateway.
<ul style="list-style-type: none"> • On the podium: 	<ul style="list-style-type: none"> • A BYOD source connected, via K-Spider adapter cable, to WP-871xr DGK transmitter that is connected to the PT-872xr receiver. • Remote buttons connected to the remote contact closure pins on the VS-411XS.
<ul style="list-style-type: none"> • Next to the door near the entrance: 	<ul style="list-style-type: none"> • Remote buttons connected to the remote contact closure pins on the VS-411XS.
<ul style="list-style-type: none"> • In the room: 	<ul style="list-style-type: none"> • VS-411XS HDMI output is connected to a projector via PT-3H2 HDMI extender, and audio output is connected to the Tavor 5-O speakers. • The window blinds and projector screen are connected to GPIO/relay pins on the FC-28 IP control gateway.
<ul style="list-style-type: none"> • LAN connections 	<ul style="list-style-type: none"> • VS-411XS, FC-28 IP control gateway, KT-107, and a Kramer Network control system.

VS-411XS, built-in Maestro configuration enables almost immediate control over these elements for different scenarios, once all the elements in the room are connected (with minimal settings via built-in Maestro automation embedded web pages, such as device-specific IP addresses, see [Configuring Device Control](#) and Automation on page 41).

For example, the remote button on the podium, connected to the contact closure pin on **VS-411XS**, is defined as a trigger for starting a presentation.

Once the button is pressed, the **PresentationStart**, built-in script, runs a series of actions such as unmuting the audio and video outputs, turning the projector ON via CEC, lowering the screen rolling the blinds down, etc.

In this example, the projector is turned on via the CEC-TV port, relays on the **FC-28** are activated via the Non-serial-onGW port (by defining the gateway IP address), and audio and video are unmuted by the internal port.

Factory default triggers, Scenarios, actions and ports are listed in [Default Automation settings](#) on page 62.

In addition to remote button triggers, the room can also be controlled via **KT-107** touch panel buttons (see [Maestro Kramer Aware Touch Panel](#) Control on page 14), or a control station included in Kramer Network management (see www.kramerav.com/product/kramer%20network).

Maestro Kramer Aware Touch Panel Control

VS-411XS Maestro room control and automation includes a built-in default configuration for optional (purchased separately) Kramer Aware touch panel that includes all the essential buttons enabling room control.



Figure 10: Default Kramer Aware Room Control Panel

You can add or remove elements from the panel (see [Operating via Maestro Kramer Aware Touch Panel](#) on page 45) or start using it immediately following minimal settings.

Operating and Controlling VS-411XS

Using Front Panel Buttons

Use the front panel to control VS-411XS. Press:

- **IN** buttons (2) to select an input.
- **VOL** buttons (3) to increase or decrease the buttons.
- **MUTE** to mute/unmute the audio output.

Setting DIP-Switches

The 4 DIP-switches (1) located on the front panel are used for setting the switching mode and for CEC notifications.

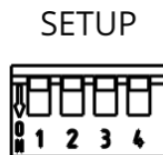

Figure 11: SETUP DIP-switches

All DIP-switches are set to Off (up) by default. DIP-switch changes take effect immediately.

#	Feature	Dip-Switch Settings
1	Switching Mode	OFF (up) – Auto-switching mode. ON (down) – Manual mode.
2	Auto-switching Mode	OFF (up) – Last connected switching mode: the last detected active source is auto-switched to the output. ON (down) – Priority switching mode: the device switches the source with the highest priority to the output.
3	CEC Notifications	OFF (up) – CEC notifications enabled. ON (down) – CEC notifications disabled.
4	Reserved for Factory Use	It is mandatory to keep set to OFF (up).

Using Contact Closure Remote Control Pins

The REMOTE terminal block connector includes input, volume and mute pins.

The contact closure remote control pins operate in a similar way to the front panel push buttons. Using the contact closure remote control (also known as push-to-make momentary contact) you can select an input, set the volume or mute the audio output.

If contact closure buttons are set to Custom (see [Setting Remote Buttons](#) on page 25) they are used to activate triggers that are set via Maestro (see [Configuring Device Control and Automation](#) on page 41).

You can connect remote, momentary-contact contact closure switches to the Remote 8-pin terminal block connector (10) to control the unit.

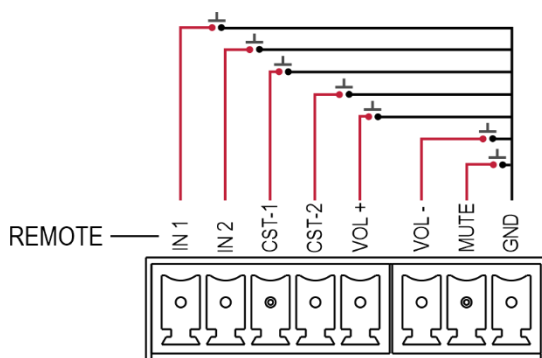

Figure 12: VS-211XS Remote Switches

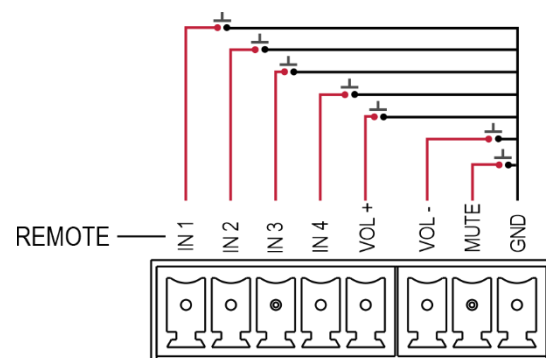

Figure 13: VS-411XS Remote Switches

Connection	Function
IN	Select an input or alternatively activate custom triggers set up in Maestro: VS-211XS: by momentarily connecting IN 1, IN 2, CST-1 and CST-2 to GND. (Configured via the embedded web pages). VS-411XS: by momentarily connecting IN 1, IN 2, IN 3 and IN 4 to GND. (Configured via the embedded web pages).
VOL +	Increase audio output volume.
VOL-	Decrease audio output volume.
MUTE	Mute the output audio.
GND	Grounding connection.



Do not connect more than one input pin to the G pin at the same time.

Acquiring and Discovering Plug-and-Play IP Address

By default, VS-411XS is DHCP-enabled, and the following Network settings are set:

- **Fallback IP Address** – 192.168.1.39
- **Fallback Subnet Mask** – 255.255.255.0
- **Fallback Gateway** – 192.168.1.1

To automatically acquire the IP address from DHCP server, connect **VS-411XS** to a LAN via Ethernet.

When connecting the device to LAN, the device discovers the DHCP server and then a new IP is acquired.

The fallback IP address (for first-time use) or the last-acquired IP address (for a device with an IP address other than the default) are maintained until a new IP address is acquired via DHCP server.



If DHCP server is not discovered, it attempts discovery every ~1 minute, while keeping the current IP address (fallback or last-acquired).

To renew DHCP discovery, perform factory reset via the RESET button . Following reset and web-UI factory reset, the last acquired IP address is auto enabled.

Discovering IP Address

You can discover the IP address via any of the following ways:

- [Discovering IP Address via Ethernet](#) on page [17](#).
- [Discovering IP Address by Performing Factory Reset](#) on page [18](#).
- [Discovering IP Address Router:](#) on page [18](#).
- [Discovering IP Address via RS-232](#) on page [18](#).

Discovering IP Address via Ethernet

To discover the IP address via the Ethernet:

1. Connect your PC to the **VS-411XS** Ethernet port.
2. Browse to the device unique hostname (e.g., <http://VS-411XS-0024>) to view its web-UI settings.



The Default hostname is: VS-411XS-xxxx (xxxx are the 4 last characters of the device serial ID).

3. Click **Device Settings** and then select Communication tab.
4. View current IP address.

IP address is discovered via Ethernet.

Discovering IP Address by Performing Factory Reset

To discover the IP address via factory reset:

1. Connect your PC to the **VS-411XS** Ethernet port (in point-to-point connection, with no DHCP server connected).
2. Press RESET  on the rear panel.
3. Browse to default fallback IP address to view its web-UI settings.
4. Click **Device Settings** and then select Communication tab.
5. View current IP address.

IP address is discovered via factory reset.

Discovering IP Address Router:

To discover the IP address via router:

1. Connect the **VS-411XS** Ethernet port to LAN subnet with a basic router supporting a built-in DHCP server and router web-UI.
2. Open router web-UI to identify the device IP address via the router using its unique hostname and/or its MAC address.

IP address is discovered via router.

Discovering IP Address via RS-232

To discover the IP address via RS-232:

1. Connect your PC to the **VS-411XS** RS-232 port (see [Connecting to VS-411XS via RS-232](#) on page 9).
2. Send the P3K `#NET-IP?_<CR>` command (see [Protocol 3000 Commands](#) on page 70).

IP address is discovered via RS-232 port.

Operating via Ethernet

You can connect to **VS-411XS** via Ethernet using either of the following methods:

- Directly to the PC using a crossover cable (see [Connecting Ethernet Port Directly to a PC](#) on page 19).
- Via a network hub, switch, or router, using a straight-through cable (see [Connecting Ethernet Port via a Network Hub](#) on page 21).



If you want to connect via a router and your IT system is based on IPv6, speak to your IT department for specific installation instructions.

Connecting Ethernet Port Directly to a PC

You can connect the Ethernet port of **VS-411XS** directly to the Ethernet port on your PC using a crossover cable with RJ-45 connectors.



This type of connection is recommended for identifying **VS-411XS** with the factory configured default fallback IP address.

After connecting **VS-411XS** to the Ethernet port, configure your PC as follows:

1. Click **Start > Control Panel > Network and Sharing Center**.
2. Click **Change Adapter Settings**.
3. Highlight the network adapter you want to use to connect to the device and click **Change settings of this connection**.

The Local Area Connection Properties window for the selected network adapter appears as shown in [Figure 14](#).

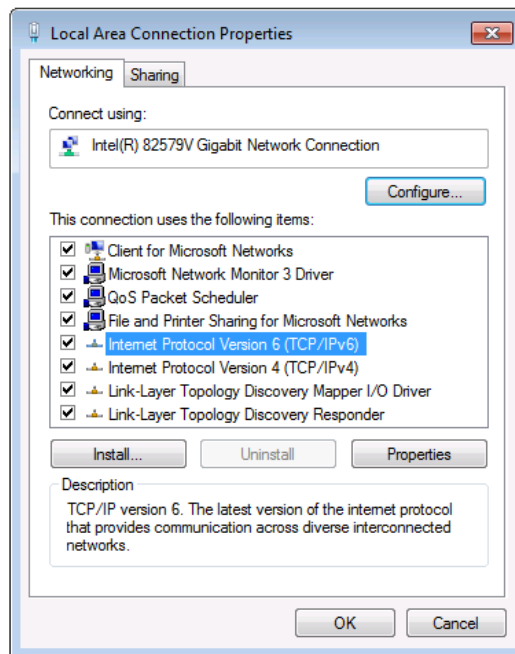

Figure 14: Local Area Connection Properties Window

4. Highlight either **Internet Protocol Version 6 (TCP/IPv6)** or **Internet Protocol Version 4 (TCP/IPv4)** depending on the requirements of your IT system.
5. Click **Properties**.

The Internet Protocol Properties window relevant to your IT system appears as shown in [Figure 15](#) or [Figure 16](#).

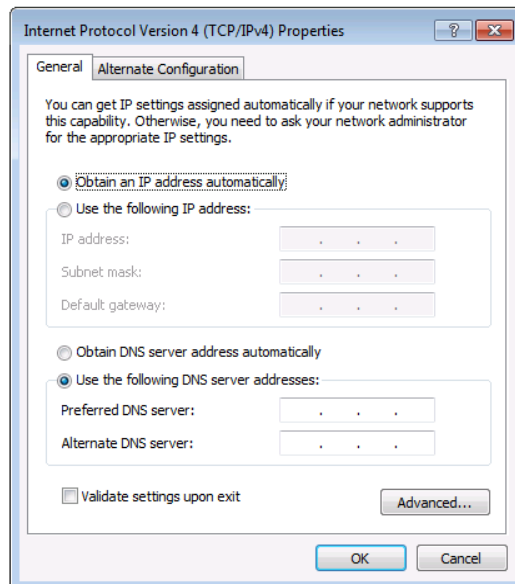

Figure 15: Internet Protocol Version 4 Properties Window

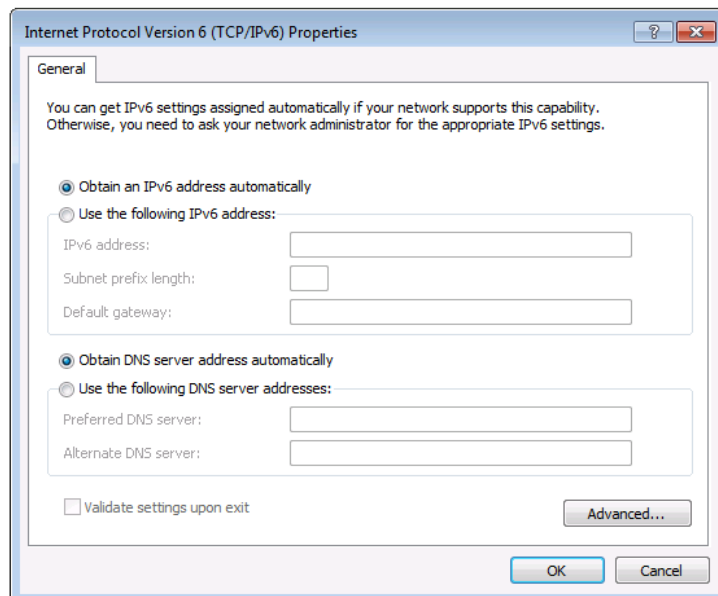

Figure 16: Internet Protocol Version 6 Properties Window

6. Select **Use the following IP Address** for static IP addressing and fill in the details as shown in [Figure 17](#).

For TCP/IPv4 you can use any IP address in the range 192.168.1.1 to 192.168.1.255 (excluding 192.168.1.39).

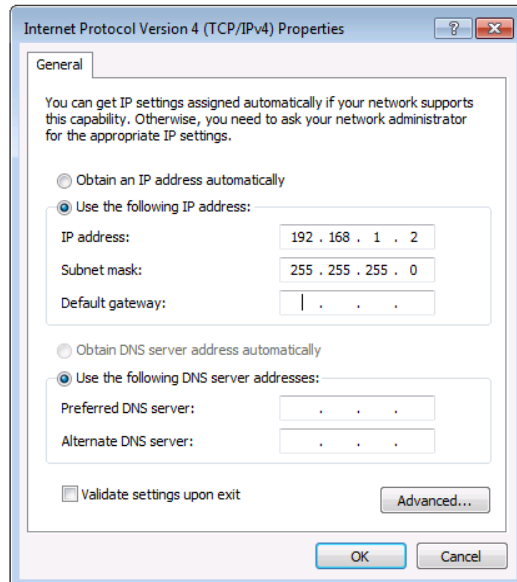

Figure 17: Internet Protocol Properties Window

7. Click **OK**.
8. Click **Close**.

Connecting Ethernet Port via a Network Hub or Switch

You can connect the Ethernet port of **VS-411XS** to the Ethernet port on a network hub or using a straight-through cable with RJ-45 connectors.

Configuring Ethernet Port

You can set the Ethernet parameters via the embedded Web pages.

Using Embedded Web Pages



This section describes the **VS-411XS** embedded web pages which applies also to the **VS-211XS** web pages.

VS-411XS can be operated remotely using the embedded Web pages. The Web pages are accessed using a Web browser and an Ethernet connection.

Before attempting to connect:

- Perform the procedures in [Operating via Ethernet](#) on page [18](#).
- Ensure that your browser is supported.

The following operating systems and Web browsers are supported:

Operating Systems	Browser
Windows 10	Chrome (Recommended)
	Firefox
Mac	Safari
iOS	Safari
Android	Chrome



Some features might not be supported by some mobile device operating systems.

VS-411XS enables performing the following:

- [Selecting an Input](#) on page [23](#).
- [Adjusting Audio Output Volume](#) on page [24](#).
- [Viewing and Adjusting General Settings](#) on page [24](#).
- [Setting Remote Buttons](#) on page [25](#).
- [Loading and Saving Settings](#) on page [25](#).
- [Resetting Device](#) on page [26](#).
- [Defining IP Settings](#) on page [27](#).
- [Define CEC Gateway Settings](#) on page [29](#).
- [Setting Time and Date](#) on page [30](#).
- [Upgrading the Firmware](#) on page [31](#).
- [Setting Security](#) on page [32](#).
- [Setting Auto Switching Priorities](#) on page [34](#).
- [Setting Input Color Depth](#) on page [34](#).
- [Setting Output Audio Source for De-embedded Audio](#) on page [35](#).
- [Setting HDCP Support](#) on page [35](#).

- [Setting Video Signal Timeouts](#) on page [37](#).
- [Managing EDID](#) on page [38](#).
- [Configuring Device Control and Automation](#) on page [41](#).
- [Viewing About Page](#) on page [59](#).

To use the browser:

1. Open your Internet browser.
2. Type the IP number of the device, or its hostname, in the Address bar of your browser. For example, the default fallback IP address or default host name (see [Discovering IP Address via Ethernet](#) on page [17](#)):



The device operation page appears.

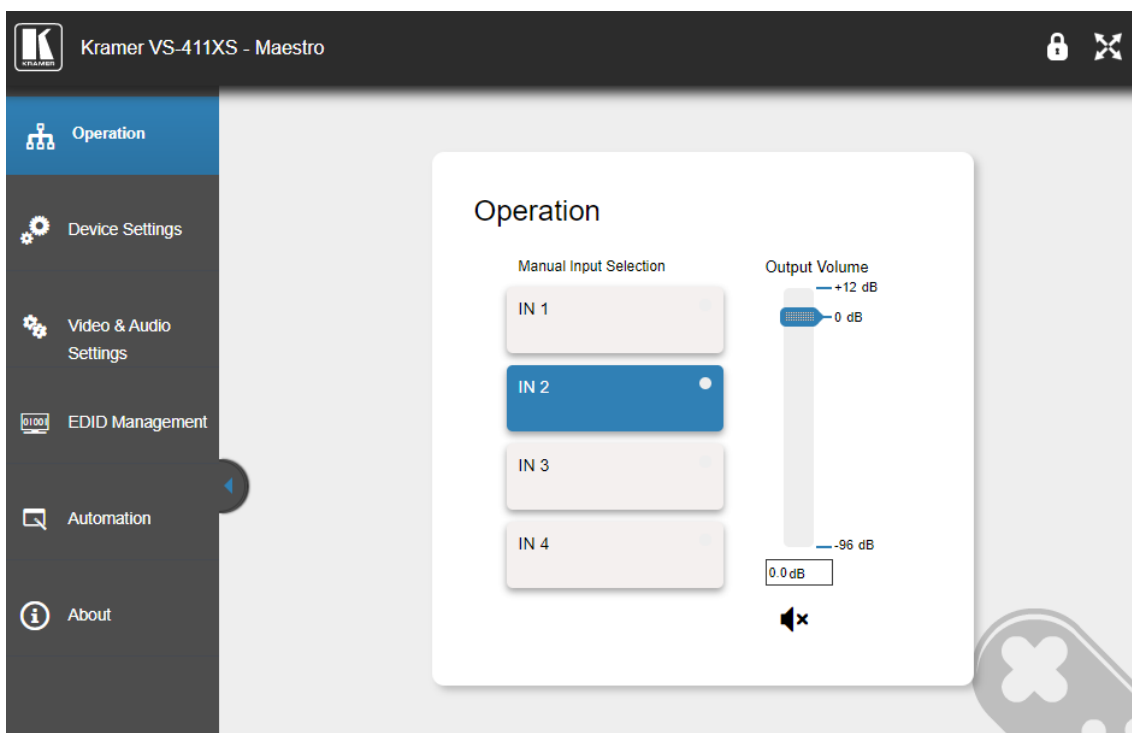

Figure 18: Operation Page with Navigation List on Left

3. Click the tabs on the left side of the screen to access the relevant web page.

Selecting an Input

You can manually select an input. Manual selection via the front panel buttons or the embedded webpage overrides the auto-switching mode.



To select an input:

1. Click **Operation** on the Navigation List.
The Operation page appears ([Figure 18](#)).
2. Click an IN button.
The input is selected and the button on the front panel is lit.

Adjusting Audio Output Volume

You can adjust the **VS-411XS** output volume.

To adjust the audio output volume:

1. Click **Operation** on the Navigation List.
The Operation page appears ([Figure 18](#)).
2. Use the Output Volume slider to adjust the volume or enter audio level value in the text box below the slider.
3. View audio mute status  /  (unmute/mute) or click to change the status.



The audio signal remains mute when decreasing the volume and unmutes automatically when increasing the volume.

The output audio volume is adjusted.

Viewing and Adjusting General Settings

To view and adjust general settings:

1. Click **Device Settings** on the Navigation List.
The General tab in the Device Settings page appears.

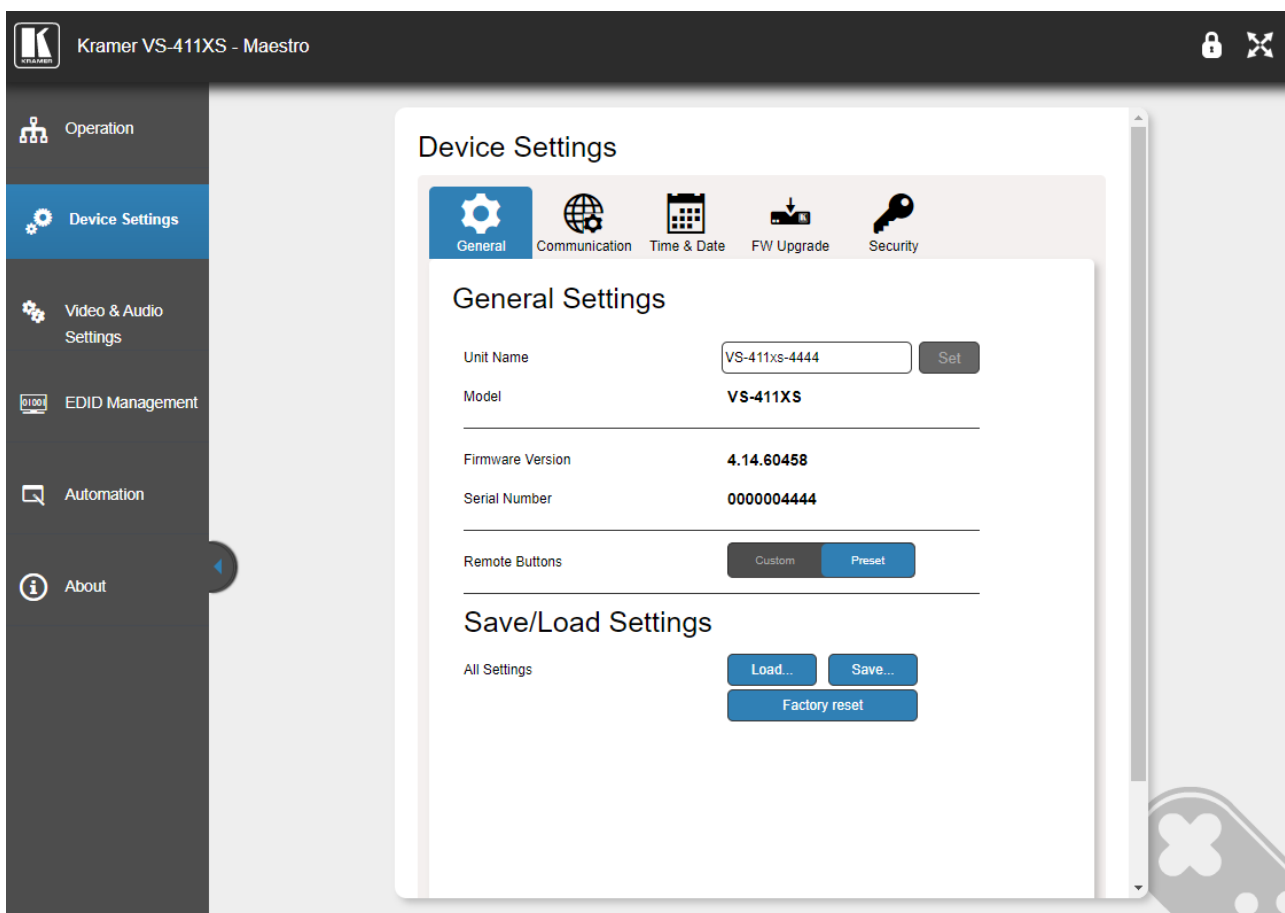

Figure 19: Device Settings Page – General Settings

2. Next to Unit Name, enter the device name and click **Set**.
3. View model name, firmware version and serial number.

General settings are viewed/set.

Setting Remote Buttons

You can define the function of the REMOTE contact closure pins (see [Using Contact Closure Remote Control Pins](#) on page 16).

To define the REMOTE contact closure buttons:

1. Click **Device Settings** on the Navigation List.
The General tab in the Device Settings page appears ([Figure 19](#)).
2. Next to Remote Buttons, define button functionality.
 - **Preset** – Maintains PINs default functionality.
 - **Custom** – All PINs act as GPI/O inputs and are configured via Maestro (see [Configuring Device Control and Automation](#) on page 41).



For VS-211XS, CST-1 and CST-2 are GPI/O inputs by default.

REMOTE PIN functionality is defined.

Loading and Saving Settings

VS-411XS enables saving the current configuration settings (such as all the Maestro settings, auto-switching settings, audio level and audio settings, and so on) for easy configuration duplication on similar systems or recall in the future.

Saving Configurations

To save a configuration:

1. Click **Device Settings** on the Navigation List.
The General tab in the Device Settings page appears ([Figure 19](#)).
2. Click **Save**.
The device saves the configuration and then the Download File message appears.

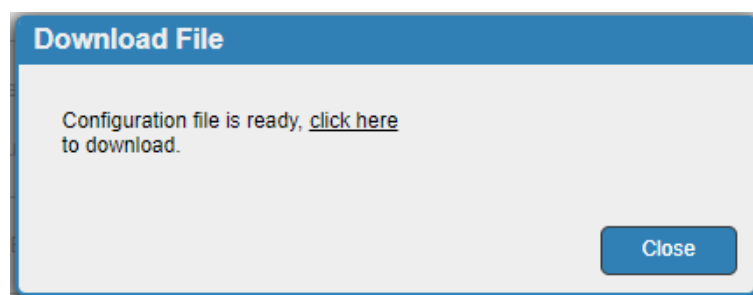

Figure 20: General Settings – Download File Message

3. Click **click here** to download the file.
4. Click **Close**.



When using Chrome, the file is automatically saved in the Downloads folder.

Current Settings are Saved.

Loading Configurations

To load a configuration:

1. Click **Device Settings** on the Navigation List.
The General tab in the Device Settings page appears ([Figure 19](#)).
2. Click **Load**.
An Explorer window opens.
3. Select the required file and click **Open**.

The device is configured according to the saved preset.

Resetting Device

You can reset the device to its default parameters, including model name and network settings (such as TCP/UDP port numbers, IP address and so on).

To reset the device to its factory default parameters:

1. Click **Device Settings** on the Navigation List.
The General tab in the Device Settings page appears ([Figure 19](#)).
2. Click **Factory reset**. The Communication warning appears.

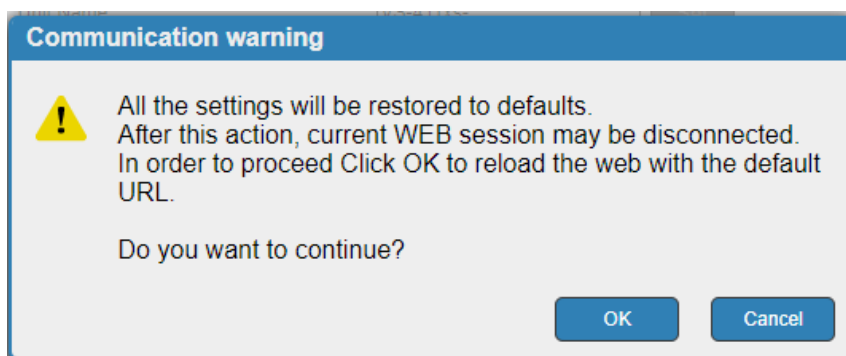

Figure 21: General Settings – Communication Warning

3. Click **OK**.



Following factory reset, the device resets to DHCP ON. If no DHCP server is found, the device falls back to its default fallback IP settings (see [Acquiring and Discovering Plug-and-Play IP Address](#) on page [17](#) and [Default Communication Parameters](#) on page [62](#)).

The device resets to its default parameters.

Defining IP Settings

By default, VS-211XS is DHCP enabled (see [Discovering IP Address](#) on page 17 for discovering the IP address). If a DHCP server is not available, the device falls-back to the default IP address (see [Default Communication Parameters](#) on page 62). you can change the IP settings as required via the embedded web pages.

Disabling DHCP

To Disable DHCP:

1. Click **Device Settings** on the Navigation List.
2. Select Communication tab.

The screenshot shows the 'Device Settings' page with the 'Communication' tab selected. The 'IP Settings' section includes a DHCP toggle set to 'OFF', and input fields for IP address (192.168.1.39), Mask address (255.255.255.0), and Gateway address (192.168.1.2). The Mac address is 00-1d-56-03-8d-13. UDP and TCP ports are both set to 5000. The 'CEC Settings' section has a CEC gateway toggle set to 'ON' and a Members address list field containing '[14]' with a 'Refresh' button.

Figure 22: Device Settings Page – Communication Tab

3. Click **OFF** next to DHCP. The DHCP message appears.



Figure 23: Communication Tab-DHCP OFF Message

4. Check **Custom IP** (and enter the address) or **Default IP**.
 5. Click **Apply**. The webpage reloads.
 6. Enter the required IP settings.
 7. Click **Set**.
- DHCP is disabled.

Enabling DHCP

To enable DHCP

1. Click **Device Settings** on the Navigation List.
2. Select Communication tab.
3. Click **ON** next to DHCP. A communication warning appears.

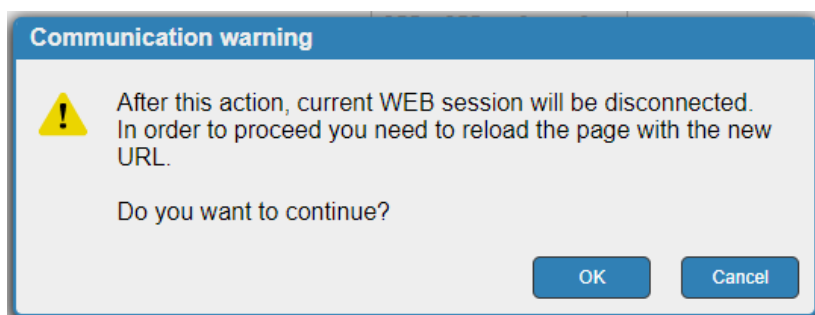

Figure 24: Communication Tab – Communication Warning Message

4. Click **OK**.
- DHCP is enabled.

Changing TCP/UDP Port Numbers

By default, TCP/UDP port numbers are set to 5000/50000 respectively.

To change the port numbers:

1. Click **Device Settings** on the Navigation List ([Figure 22](#)).
2. Select Communication tab.
3. Enter the new port number or use the up/down arrows to set the new port number.
4. Click **Set**.

Port numbers have changed.

Define CEC Gateway Settings

VS-411XS built-in CEC gateway enables IP control of control system, via CEC messages, on HDMI connected devices to the selected input and the output port (see [IP-Driven CEC Signals Routing via Built-in Control Gateway](#) on page [11](#)). The Members address list shows the logical addresses of connected CEC-enabled devices.



By-default, CEC gateway is enabled.

To disable CEC gateway feature:

1. Click **Device Settings** on the Navigation List ([Figure 22](#)).
2. Select Communication tab.
3. Click CEC gateway **OFF**.

CEC gateway is disabled.

You can view the logical addresses of CEC-enabled devices that are connected via HDMI output port to **VS-411XS** and click **Refresh** to refresh the list.

Setting Time and Date

You can set a device time and date manually or Sync the device time and date to any server around the world.

To set device time and date manually:

1. In the Navigation pane, click **Device Settings**.
2. Select the Time & Date tab. The Time & Date tab appears.

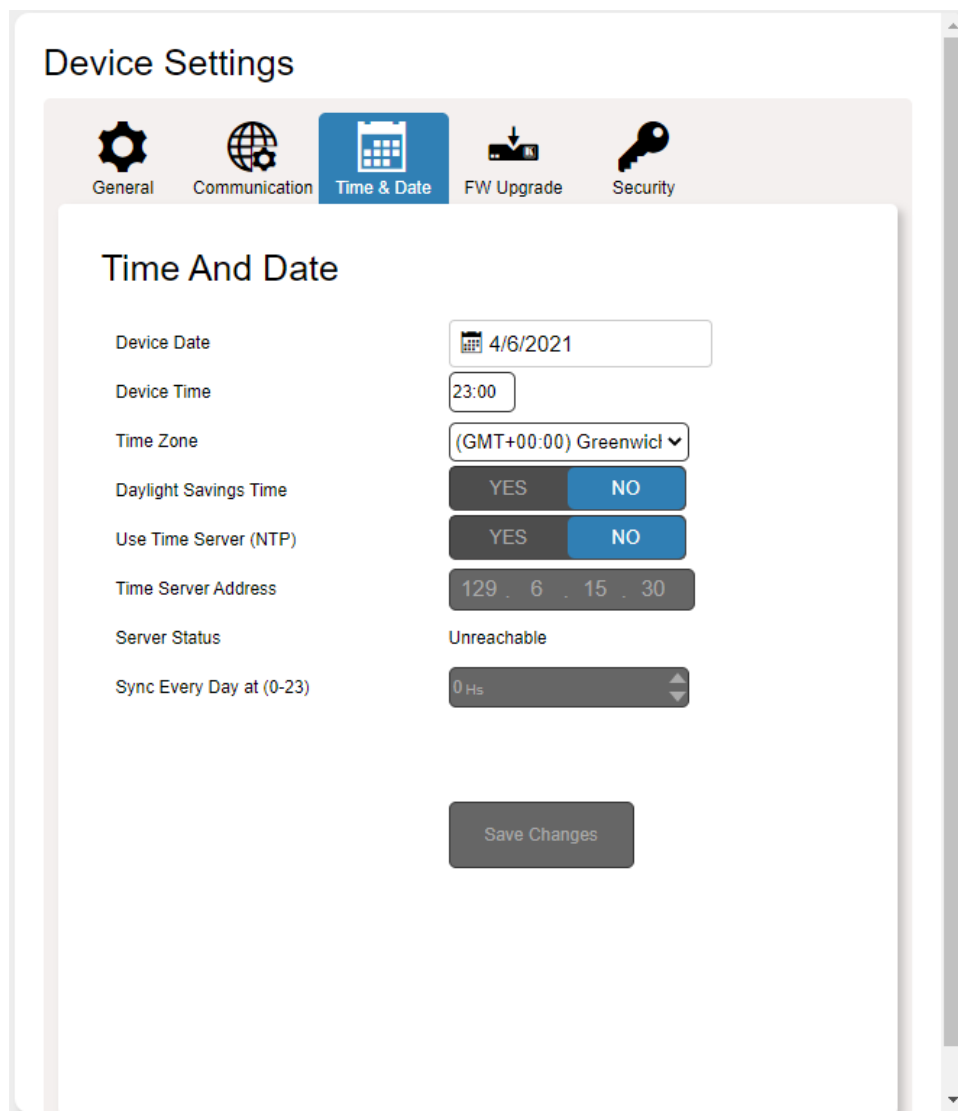

Figure 25: Device Settings Page – Time and Date Tab

3. Next to Use Time Server (NTP), click **NO**. Device time & date fields are enabled and network fields are disabled.
4. Set the device date and time manually.
5. Select the time zone.
6. Click **Save Changes**.

The devices date and time are set.

To sync device time and date to a server:

1. In the Navigation pane, click **Device Settings**.
2. Select the Time & Date tab. The Time & Date tab appears ([Figure 25](#)).
3. Next to Use Time Server (NTP), click **YES** to use time server (NTP).
Device Time & Date Fields are disabled, and network fields are enabled.
4. Type in server information:
 - Enter the address.
 - Set sync schedule.
5. Click **Save Changes**.

The devices date and time are synchronized to the server address entered.

Upgrading the Firmware

As features are added, new firmware versions are released for downloading on the Kramer website.

To upgrade the firmware:

1. In the Navigation pane, click **Device Settings**.
2. Select the FW Upgrade tab. The FW Upgrade tab appears.

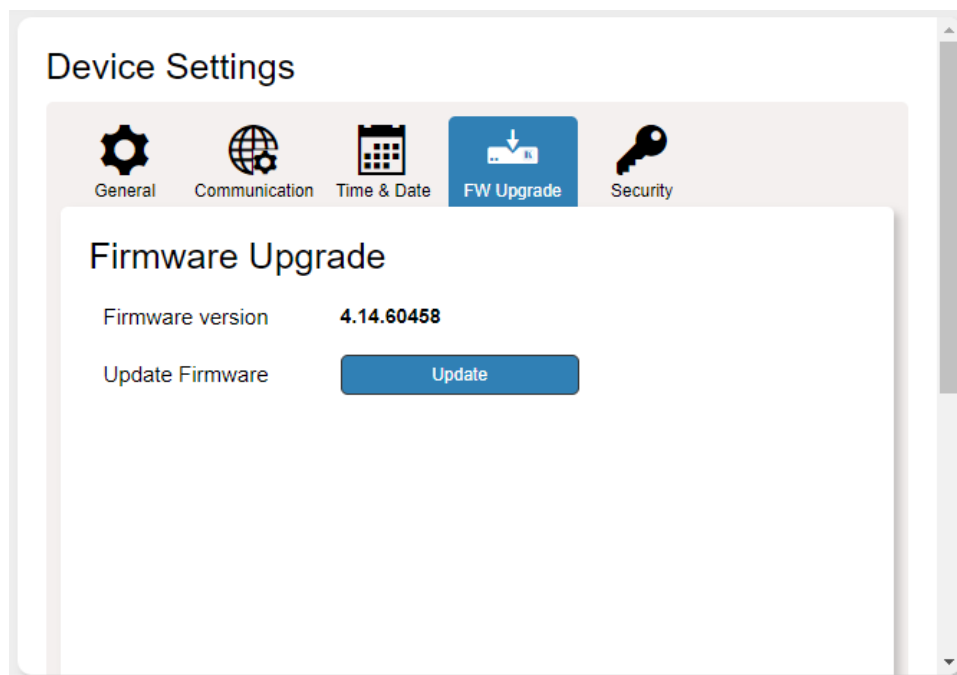

Figure 26: Device Settings Page – Firmware Upgrade tab

3. Click **Update**. The Windows Browser opens.
4. Browse to the required file and click **Open**. The firmware file name is displayed in the Firmware Upgrade tab.

5. Click **Start Upgrade**. The firmware file is loaded, and a progress bar is displayed.



Do not interrupt the process or the **VS-411XS** may be damaged.



6. When the process is complete reboot the device.

The firmware is upgraded.



You can upgrade firmware for multiple **VS-411XS** devices installed in the organization via Kramer Network.

Setting Security

The Security tab enables activating device security and defining logon authentication details. When device security is enabled, web page access requires authentication upon initial landing on operation page. The default password is **Admin**. The upper right corner of the webpage displays  or  indicating whether authentication is required. By default, security is enabled.

To disable security:

1. In the Navigation pane, click **Device Settings**.
2. Select Security tab. The Security tab appears.

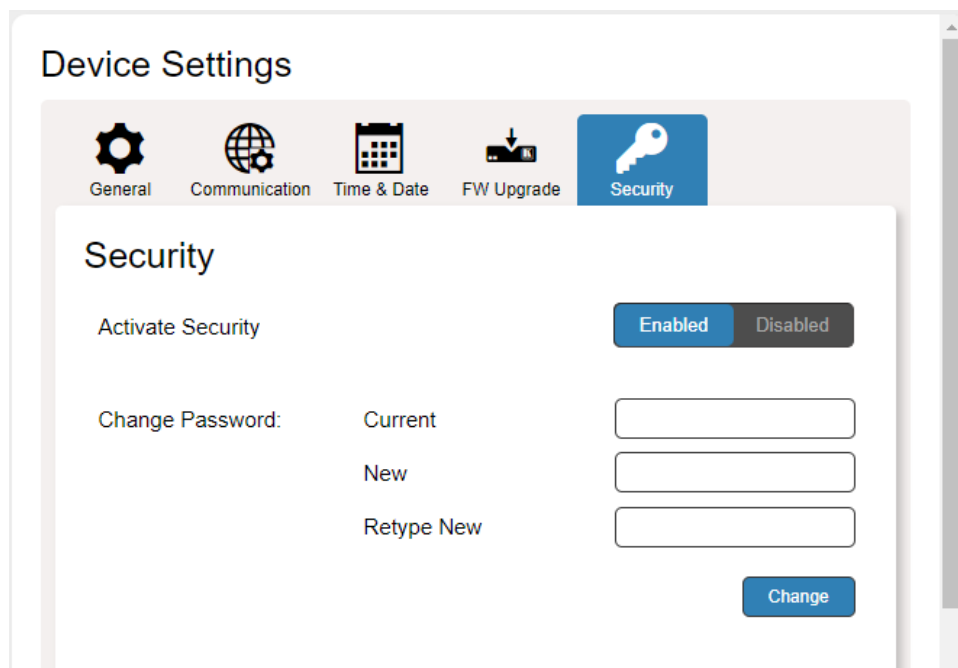

Figure 27: Device Settings – Security Enabled

3. Click **Disabled**. A Confirmation message appears.

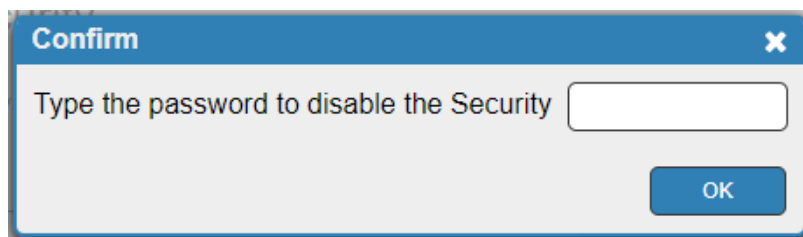



Figure 28: Security Tab – Confirmation Message

4. Enter the Password (Admin, by default).
5. Click **OK**. The password fields disappear, and the upper right icon changes to . Security is disabled.

To enable security:

1. In the Navigation pane, click **Device Settings**.
2. Select Security tab.

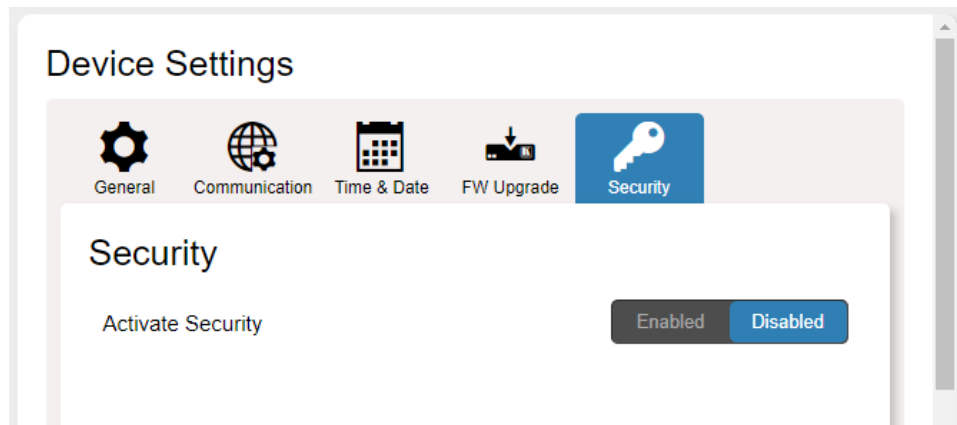

Figure 29: Device Settings – Security Tab

3. Click **Enabled**. A warning message appears.

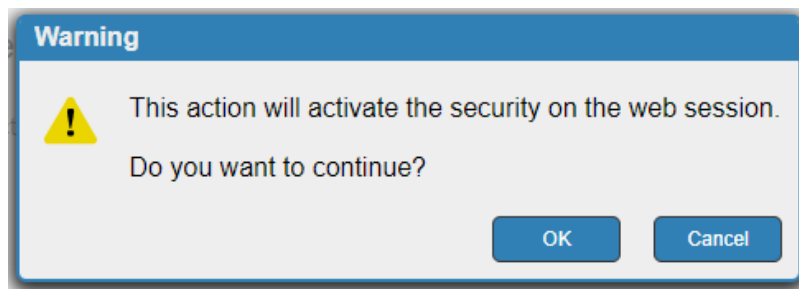



Figure 30: Security Tab – Warning Message

4. Click **OK**. The web page refreshes, and the password fields are visible.
5. If required, type the current password and new password twice and click **Change**.

The upper right icon changes to .

Security is enabled.

Setting Auto Switching Priorities

By default, VS-411XS is set via the SETUP DIP-switches (see [Setting DIP-Switches](#) on page 15) to auto-switching, last-connected switching mode. You can view current switching mode and change switching priorities (applicable to Priority mode only) via the embedded web pages.

To change switching priorities:

1. In the Navigation pane, click **Video & Audio Settings**.
2. View the video selection mode.
3. Drag and drop inputs to set which inputs get higher priority.

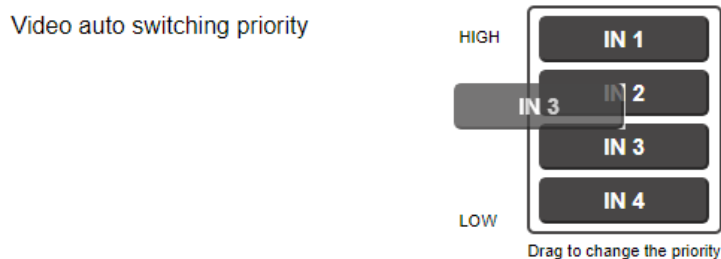

Figure 31: Dragging Input to Change Priority

The video inputs priority changes.

Setting Input Color Depth

VS-411XS enables setting the color depth per input.

To Set the Color Depth on an input:

1. In the Navigation pane, click **Video & Audio Settings**.
2. Next to each input, click one of the following:
 - **Follow Output** (default), to follow the output color depth.
 - **Force 8-bit** color graphics.

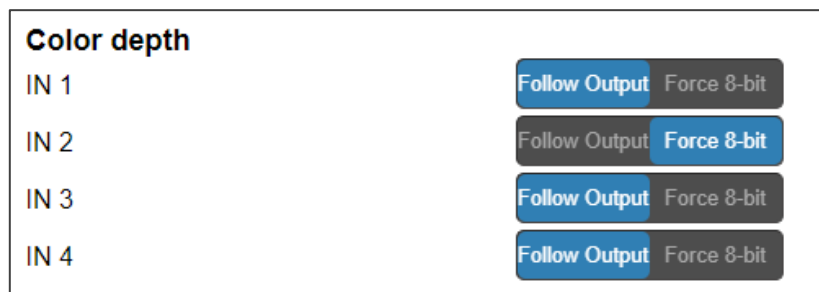

Figure 32: Video & Audio Settings – Color Depth

Color Depth is defined.

Setting Output Audio Source for De-embedded Audio

2-channels of non-encrypted output HDMI audio are de-embedded and are output to the AUDIO OUT ⁽¹⁰⁾.

To set output audio source:

1. In the Navigation pane, click **Video & Audio Settings**.
2. Next to **De-embedded audio output**, click one of the following:
 - **Forward** (default), to output audio of the switched HDMI input, forward to the display.
 - **ARC**, to output HDMI ARC (Audio Return Channel) audio, returned backwards from the display.

Audio

De-Embedded audio output:

Forward

ARC

Figure 33: Video & Audio Settings – Audio ARC



- ARC signal passes between the output display and the switched input source (excluding VS-411XS IN 4).
- The audio source is output to the speakers connected to AUDIO OUT in parallel to its traversal to/from the display.

Output audio source is set.

Setting HDCP Support

There are video sources (e.g., some Apple devices) that automatically switch to HDCP protected mode if connected to a device that supports HDCP (e.g. VS-411XS) protection. You can set HDCP support modes on both the inputs and the output.

For example, if an acceptor connected to VS-411XS output does not support HDCP protection, you might want to disable input HDCP support, so that the video source does not auto-switch to HDCP-protected mode and driving no video display on the output acceptor.

Other HDCP support options are available, allowing flexible support according to HDCP compatibility needs between the input sources and output acceptor.

To set input HDCP support:

1. In the Navigation pane, click **Video & Audio Settings**.
The Video & Audio Settings page appears.
2. Click **Enabled** (default)/ **Disabled** for each input.

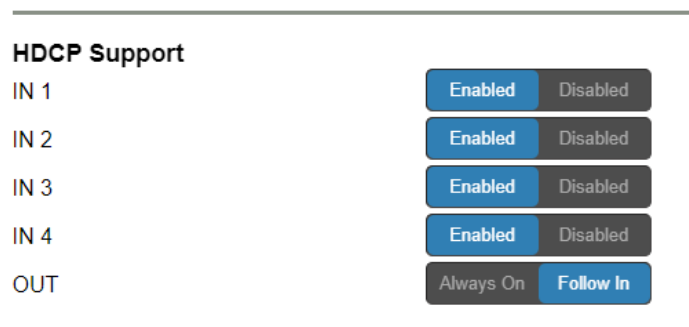

Figure 34: Video & Audio Settings – HDCP Support

Input HDCP support is set.

To set output HDCP support:

1. In the Navigation pane, click **Video & Audio Settings**.
The Video & Audio Settings page appears.
2. Click **Always On**/ **Follow In** (default).

Output HDCP support is set.

Setting Video Signal Timeouts

VS-411XS enables setting the time delay before triggering auto-switching and display auto-sleep entry.

To set the timeout for auto-switching video inputs if signal is lost:

1. In the Navigation pane, click **Video & Audio Settings**.
2. Under “When the HDMI signal is lost, leave 5V power ON and delay switching for” set the delay time 0-905 seconds (where 0 is no timeout, 10 is the default).

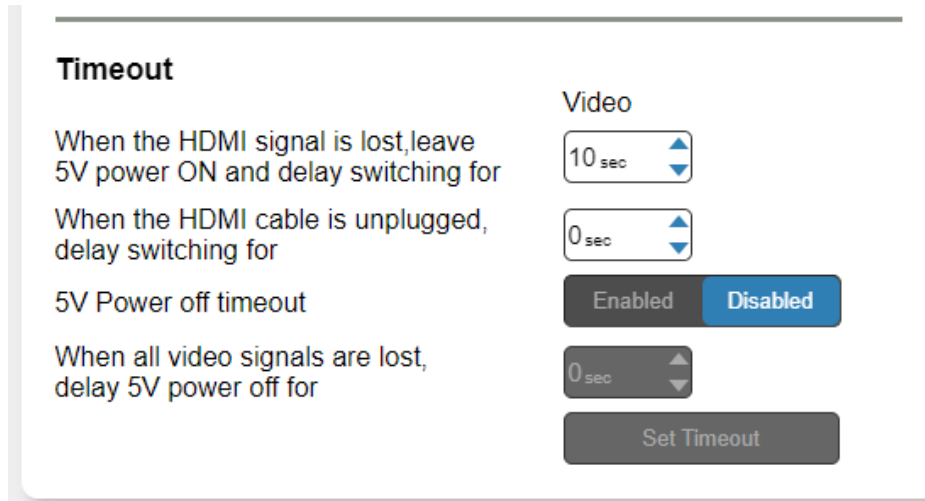

Figure 35: Video & Audio Settings – Timeouts

3. Click **Set Timeout**.

Auto-switching on signal-lost timeout is set.

To set the timeout for auto-switching video inputs for unplugged HDMI cable:

1. In the Navigation pane, click **Video & Audio Settings**.
2. Under “When the HDMI cable is unplugged, delay switching for” set the delay time 0-905 seconds (where 0 is no timeout and the default).
3. Click **Set Timeout**.

Auto-switching on cable-unplug timeout is set.

To set display auto-sleep entry no AV signal is detected:

1. In the Navigation pane, click **Video & Audio Settings**.
2. Next to “5V Power off timeout” click **Enabled**. The timeout field beneath the button is enabled.

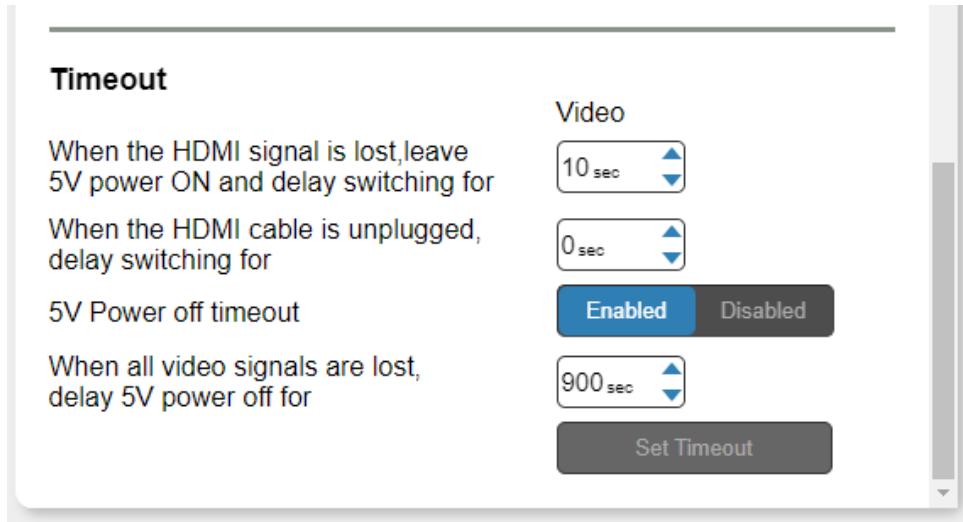

Figure 36: Video & Audio Settings – 5V Power Off Timeout

3. Under “When all video signals are lost, delay 5V power off for” set the delay time from 30-60,000 seconds (where 900 is the default).

Display auto-sleep entry timeout is set.

Managing EDID

VS-411XS enables copying EDID data to either one or several inputs (for use by the connected sources) from the following EDID sources:

- Inputs
- Output
- Default EDID
- Custom EDID data file



When the status of an EDID changes on the device (caused by outputs being exchanged), the display is not updated automatically. In the browser, click **Refresh** to update the display.



An input must be connected to the device to read the EDID from a connected output. If a video signal is not detected on the input, the output is disabled and the EDID cannot be read.

The selected EDID can be copied to the selected input/s.



View the currently selected EDID source Bytemap by clicking **Bytemap** on the right side.

To copy an EDID from an output / input to an input:

1. In the Navigation pane, click **EDID Management**.
2. Select the EDID source (for example, the output).



If you are reading EDID from an output, make sure that that output is connected to an acceptor.

3. Select one or more inputs.

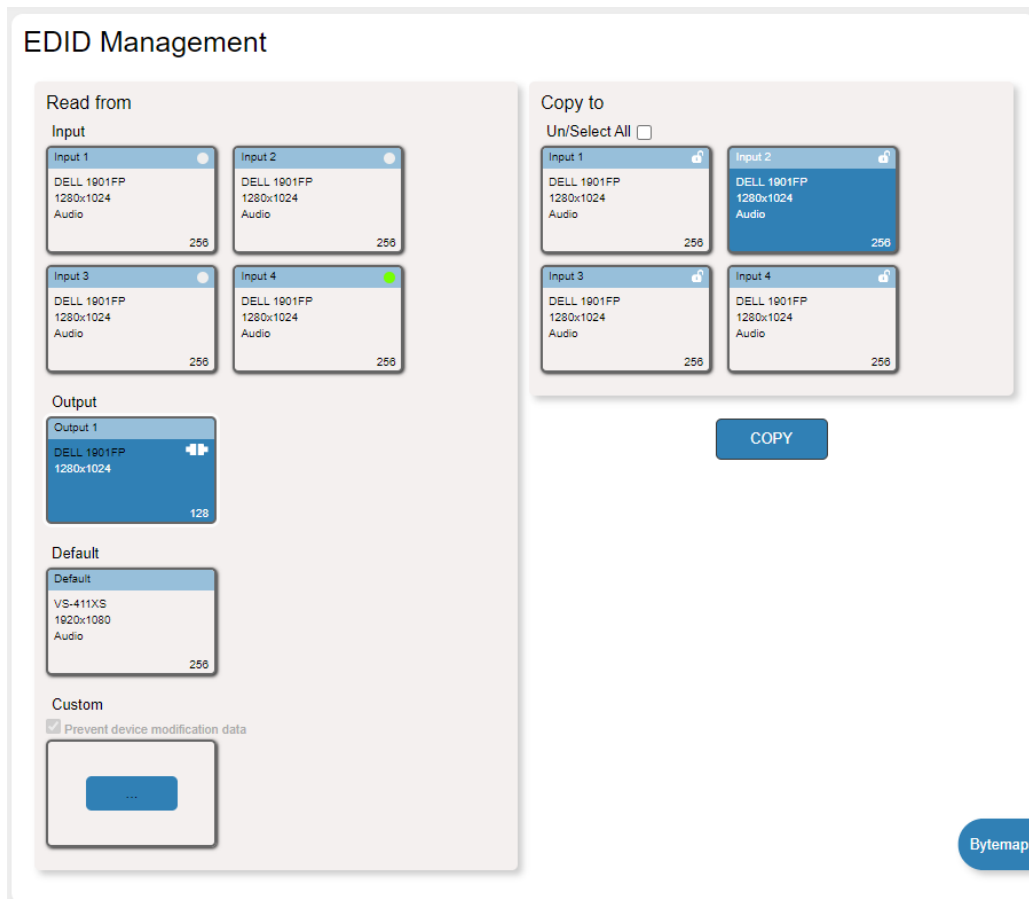

Figure 37: EDID Management Page – Copying EDID from the Output

4. Click **COPY**.

The EDID is copied to the selected inputs.

To read the EDID from the default EDID:

1. In the Navigation pane, click **EDID Management**.
2. Click **Default**.
3. Select one or more inputs.

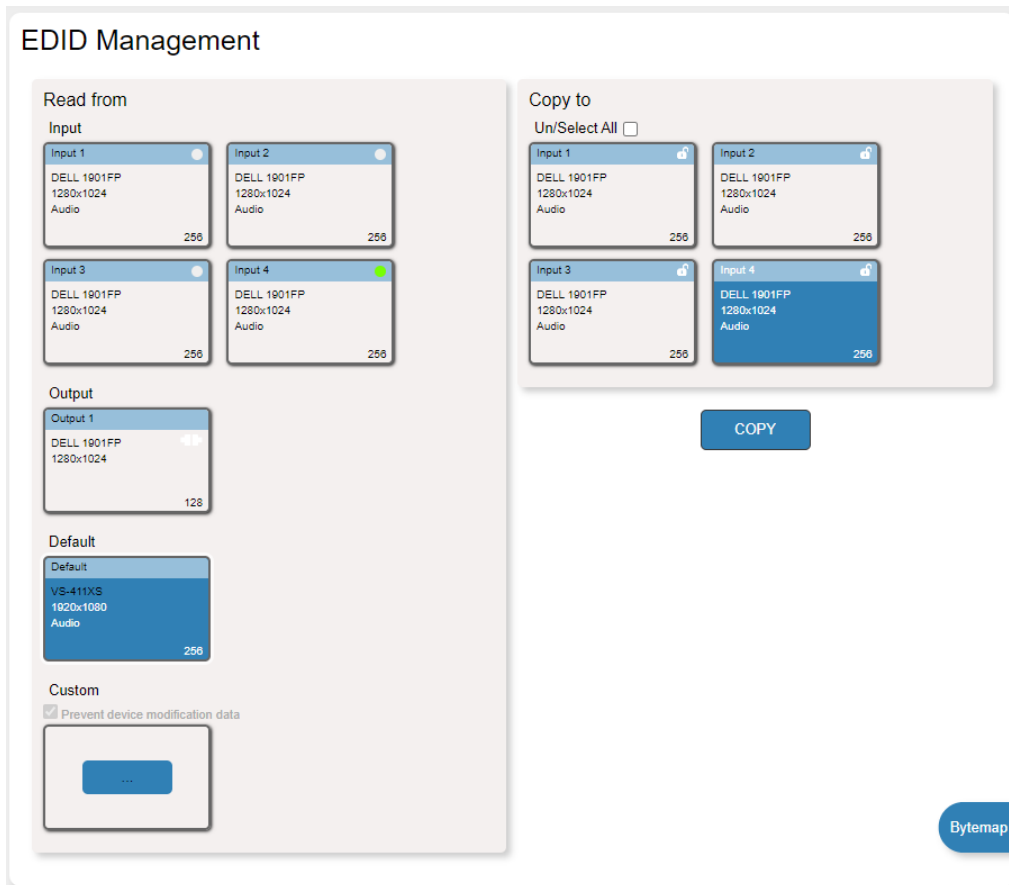

Figure 38: EDID Management Page – Copying Default EDID

4. Click **COPY**.

The default EDID is copied to the selected inputs.

To import a customized EDID file:

1. In the Navigation pane, click **EDID Management**.
2. Click **Custom**. The Windows Browser opens.
3. Select the custom EDID file and click **Open**. The file is selected.
4. Select one or more inputs and click **COPY**.

The custom EDID file is copied to the selected inputs.

Configuring Device Control and Automation

Use the Automation page to access built-in **Kramer Maestro V1.5** room control and automation. **Maestro** is a powerful built-in tool that enables you to configure triggers for room control and automation scenarios without the need for complicated programming. To use **Maestro** control and automation, you need to define triggers that, upon an event, will execute scripts which include a sequence of actions (commands, which can appear in different scenarios) that will be carried out via any defined ports.

Download the **Kramer Maestro** User Manual from the Kramer web site at www.kramerav.com/downloads/VS-211XS or www.kramerav.com/downloads/VS-411XS to learn how to use **Kramer Maestro**.



Note that all the ports, actions and triggers that are relevant to **VS-411XS** are included in the **Kramer Maestro**, as well as ports, actions and triggers that are relevant to other Kramer devices.

Configuring Ports

Maestro enables configuring the ports used to control specific room devices.

The screenshot shows the Maestro Automation interface. At the top, there are tabs for 'Automation' and 'Panel'. Below this is the 'Room Automation' section, which includes 'Cancel' and 'Save All' buttons. The main area is divided into two panels. The left panel, titled 'Ports', contains a table with the following data:

Name	Type	Details
WOL-Echo	WOL	7
WOL-Discard	WOL	9
Internal	Internal	
CEC-TV	CEC	0
CEC-Broadcast	CEC	15
NonSerial-onGV	TCP	192.168.1.40:5000

Below the table are three expandable sections: 'Actions', 'Scripts', and 'Triggers'. The right panel is a large empty box with the text 'Select an item to edit'.

Figure 39: Automation Page – Ports List

In this example, **VS-411XS** is connected to Kramer **FC-28** control gateway (optional, purchased separately). **FC-28** includes various serial and non-serial ports and is set, for example, to IP Address 192.168.1.40.

VS-411XS includes the following default ports:

Port Name	Type	Port Properties	Port Description	Comments
WOL-Echo	WOL	7		
WOL-Discard	WOL	9		
Internal	Internal			Enabling actions on the device itself, such as switching an input.
CEC-TV	CEC	0		Enabling actions such as display on/off.
CEC-Broadcast	CEC	15		
Non-Serial-on-GW	TCP	192.168.1.40, 5000	Gateway Non-serial ports	For example, Relay, GPIO and IR control on the FC-28 gateway.

You can add ports to Maestro (see www.kramerav.com/downloads/VS-211XS) for example, if **VS-411XS** is connected to **FC-28**, you can add, for example, gateways for the two RS-232 serial ports on the **FC-28**.

Port Name	Type	Port Properties	Port Description	Comments
Display-Serial1-on-GW	TCP	192.168.1.40, 5001	FC-28 gateway; RS-232 1 port	
Serial 2-on-GW	TCP	192.168.1.40, 5002	FC-28 gateway; RS-232 2 port	

Configuring Actions

In the Actions tab you can create new commands, and also view and edit the default commands (see [Actions List](#) on page 62) that are device specific.

Maestro

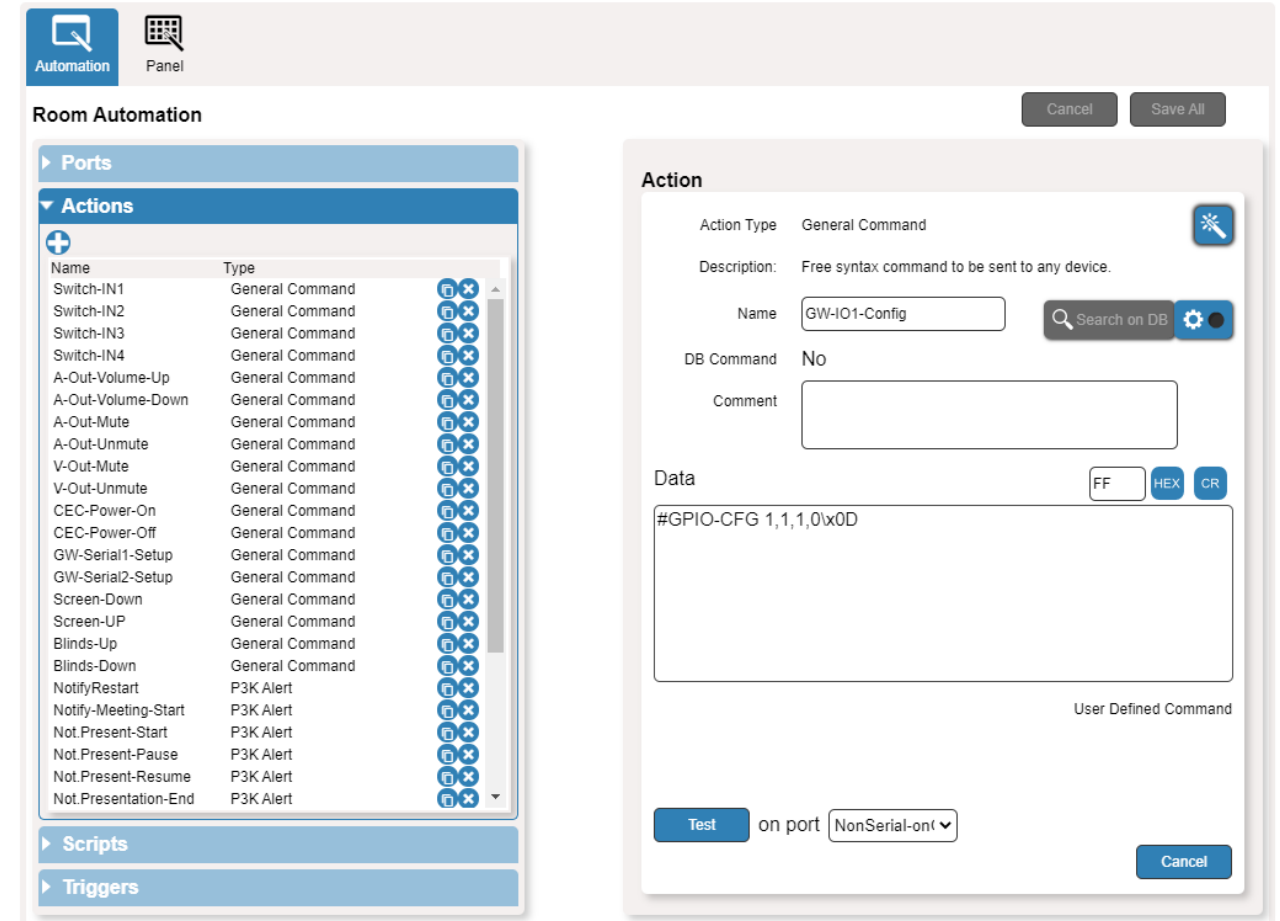

Figure 40: Automation Page – Actions List

You can add actions by duplicating an action from the list of built-in actions and changing it as required, or by a creating new action altogether (see www.kramerav.com/downloads/VS-211XS).

Configuring Scripts

A script includes several actions. You can add commands to an existing script, create new scripts or use the available built-in scripts (see [Scripts List](#) on page 64). For example, click the PresentationStart script to view its list of actions.

The screenshot shows the Maestro Automation interface. On the left, the 'Room Automation' panel is open, displaying a list of scripts under the 'Scripts' section. The 'PresentationStart' script is selected, showing it has 6 actions. On the right, the 'Script' configuration window is open for 'PresentationStart', displaying an 'Action List' with six actions:

run	on	Internal	X
V-Out-Unmute	on	Internal	X
A-Out-Unmute	on	Internal	X
CEC-Power-On	on	CEC-TV	X
Screen-Down	on	NonSerial-ont	X
Blinds-Down	on	NonSerial-ont	X
Not.Presentation-Start			X

Below the action list, there are instructions: "(Drag to arrange the Actions on the list)" and "(Drag and Drop from Actions to add one)". There are 'Test' and 'Cancel' buttons at the bottom of the window.

Figure 41: Automation Page – Scripts List

You can add, delete, or change the order of the actions in the list.

Configuring Triggers

The trigger is a predefined event that, when activated, causes the script associated to it to run. For example, click the built-in First_IN_Plugged trigger that triggers the PresentationStart script so that when an active input signal is detected, the PresentationStart script runs automatically. See default list of triggers in (see [Triggers List](#) on page 66).

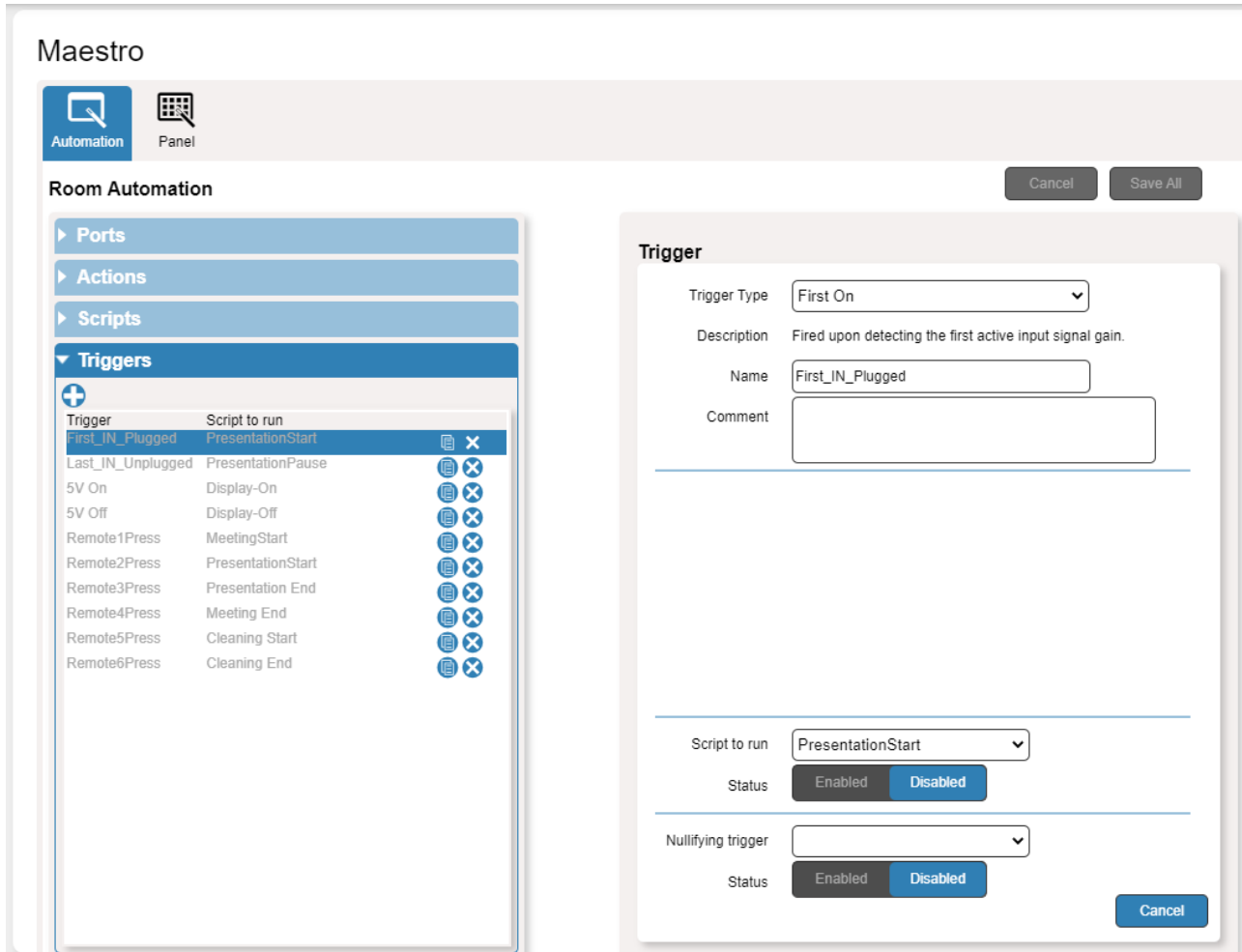

Figure 42: Automation Page – Triggers List

You can add, delete, or modify a trigger (see www.kramerav.com/downloads/VS-211XS).

Operating via Maestro Kramer Aware Touch Panel

You can control VS-411XS via any of Kramer's Kramer Aware app. touch panels (for example, KT-1010).



Kramer touch panels are purchased separately.

VS-411XS enables performing the following actions:

- Viewing and carrying out actions via the control panel in the Automation Page.
- Editing the device control panel.

Viewing and Executing Actions Via Maestro Control Panel

Before connecting to a designated Kramer Aware touch panel, you can view the Maestro default control panel and ensure the buttons are active and are suited for your needs.

To view and execute actions via the control panel:

1. In the Navigation pane, click **Automation**. The Automation page appears (see [Figure 39](#)).
2. Click the **Panel** tab (by-default, in Action mode). The default **VS-411XS** Maestro Room Control panel appears.

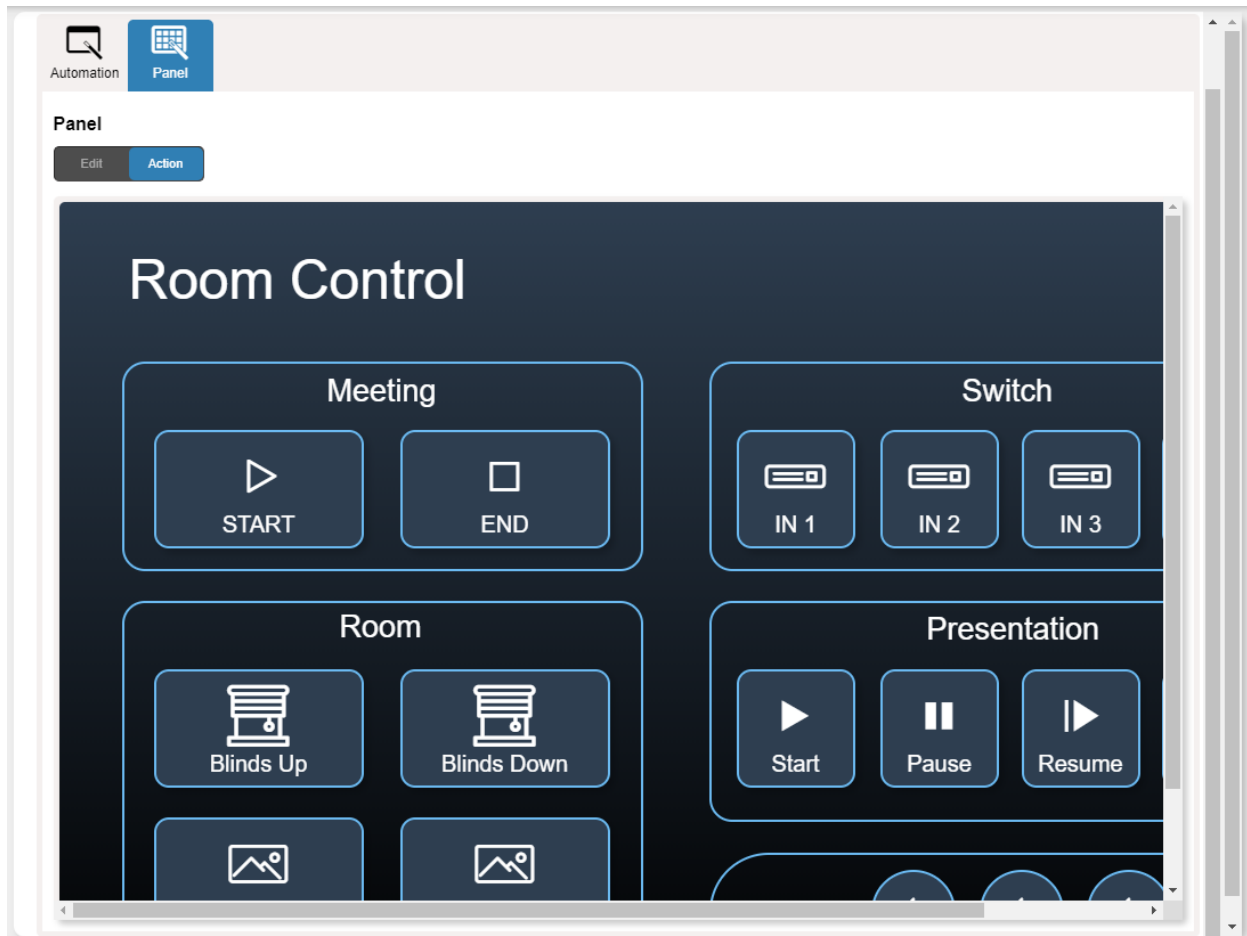

Figure 43:Automation Page – Panel Tab



The resolution of the panel fits the designated Kramer Aware touch-panel, therefore it appears in large-scale.

3. Perform the following actions:
 - Click meeting **Start** / **End** to prepare the room for a meeting (as specified in the Maestro scripts).
 - Switch one of the four inputs.
 - Control room blinds and screen **Up** / **Down**.
 - Play and control a presentation.
 - Control the audio output.

Configuring Device Control Panel

The default Maestro room control panel items can be configured to suit your needs. Each item on the panel can be modified and new items can be added. The Edit Panel window includes a display of the current Maestro control panel, the properties area to the right, the Object List below and three Add buttons to add new items to the panel next to the Object List.

The **VS-411XS** Room Control Panel enables performing the following actions:

- [Selecting Panel Model](#) on page [48](#).
- [Setting Panel Background](#) on page [49](#).
- [Defining Panel Configuration Grid](#) on page [49](#).
- [Modifying a Button](#) on page [49](#).
- [Modifying Text](#) on page [51](#).
- [Modifying a Frame](#) on page [53](#).
- [Adding a New Button](#) on page [54](#).
- [Adding a New Text Field](#) on page [56](#).
- [Adding a New Frame](#) on page [57](#).

Selecting Panel Model

To select the panel model:

1. In the Navigation pane, click **Automation**. The Automation page appears (see [Figure 39](#)).
2. Click the **Panel** tab. The default **VS-411XS** Maestro Room Control panel appears (see [Figure 43](#)).
3. Click **Edit**. Edit Panel window appears, showing the General Properties area.



You can also access General Properties by clicking the background panel area.

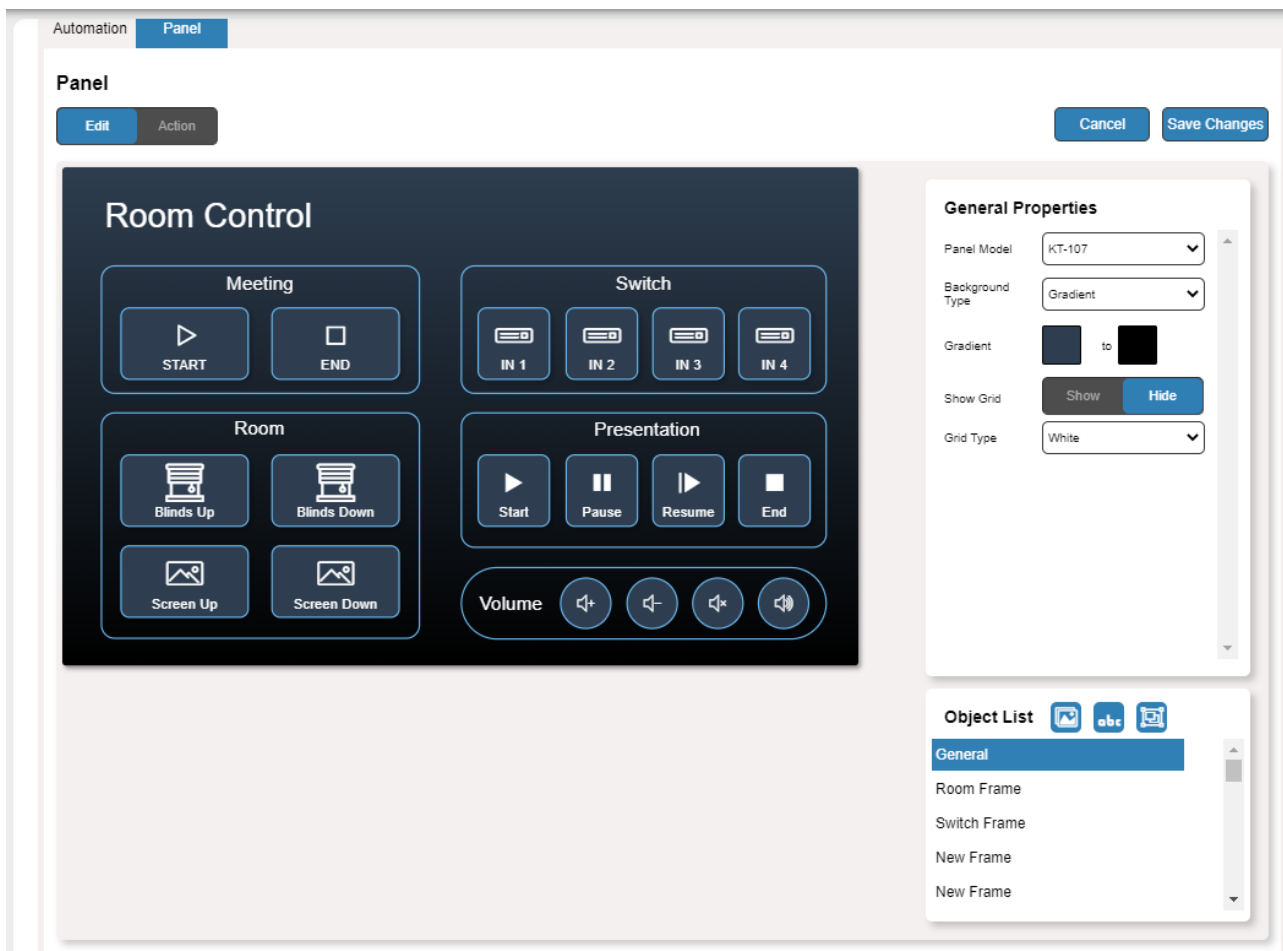

Figure 44: Automation Page – Editing Panel Window

4. From Panel Model drop-down list (in General Properties), define the panel model. If **Custom** is selected, set Panel Size (in pixels).
5. Click **Save Changes**.

Panel model is defined.

Setting Panel Background

You can select the background color and configure the background pattern.

To configure the panel background:

1. In the Navigation pane, click **Automation**. The Automation page appears (see [Figure 39](#)).
2. Click the **Panel** tab. The default **VS-411XS** Maestro Room Control panel appears (see [Figure 43](#)).
3. Click **Edit**. Edit Panel window appears (see [Figure 44](#)).
4. In General Properties area set the Background Type:
 - **Solid** – Click Background Color button to select the color.
 - **Gradient** – Click Gradient color buttons to select the gradient.
 - **Pattern** – Select the pattern colors, type, and sizes.
 - **Image** – Click Upload Image button to select an image file.

Defining Panel Configuration Grid

The background grid helps align each configured item in the panel. You can show and hide the grid and select its color for your convenience.

To define the grid:

1. In the Navigation pane, click **Automation**. The Automation page appears (see [Figure 39](#)).
2. Click the **Panel** tab. The default **VS-411XS** Maestro Control Panel appears (see [Figure 43](#)).
3. Click **Edit**. Edit Panel window appears (see [Figure 44](#)).
4. Click **Show** to show grid.
5. From Grid Type drop-down box, select the grid color.

The configuration grid is defined.

Modifying a Button

The default device control panel includes several buttons (for example, the Volume Up button) that can be modified.

To modify a button:

1. In the Navigation pane, click **Automation**. The Automation page appears (see [Figure 39](#)).
2. Click the **Panel** tab. The **VS-411XS** Maestro Control Panel appears (see [Figure 43](#)).
3. Click **Edit**. Edit Panel window appears (see [Figure 44](#)).

- Click the relevant button (in this example, **Volume UP** appears in the Object List).
Volume UP button is selected in the device control panel.



Figure 45: Edit Panel – Volume Up button Selected

The Properties (Button) and Volume UP Object list appear:

Panel

Edit Action Cancel Save Changes

Room Control

Meeting: START, END

Switch: IN 1, IN 2, IN 3, IN 4

Room: Blinds Up, Blinds Down, Screen Up, Screen Down

Presentation: Start, Pause, Resume, End

Volume: Volume UP, Volume DOWN, Mute, Unmute

Properties (Button)

Name: Volume UP

Script to Run: Audio Volume Up

Position: x: 712, y: 586

Size: h: 60, w: 60

Fill: [Color Picker]

Icon: [Volume Up Icon] Color: [Color Picker]

Show Label: Show Hide

Border Width: 2 Color: [Color Picker]

Object List

VS-411XS Panel

Volume UP

Volume DOWN

Mute

Unmute

Figure 46: Edit Panel – Properties (Button) Area

- Next to Volume UP, do any of the following:
 - Click to duplicate the button.
 - Click to remove the button.
- In the Properties (Button) area, perform any of the following actions:
 - Click to copy the selected button properties (Fill, Icon Color, Label Size and Color, Border Color, Border Width and Color, and Border Radius).
 - Click to paste button properties to a selected frame.
 - Change the button name.
 - Select the script to run when this button is pressed.
 - Set the position of the button by moving the button (or by entering the x, y position).
 - Enter button Size to change h and w button size (or use up/down arrows).

- Click the Fill color button to change the button color.
- Change the button Icon and select its Color.
- Click **Show/Hide** to show or hide the frame.
- Enter Border Width to change the button border width (or use up/down arrows).
- Click border Color button to select border color.
- Enter Border Radius to change the border edge radius (or use up/down arrows).

7. Click **Save Changes**.

This button is configured.

Modifying Text

The Maestro Control panel includes Text (for example, Presentation). You can modify a button, using the Panel Edit tab.

To modify the text:

1. In the Navigation pane, click **Automation**. The Automation page appears (see [Figure 39](#)).
2. Click the **Panel** tab. The **VS-411XS** Maestro Control panel appears (see [Figure 43](#)).
3. Click **Edit**. Edit Panel window appears (see [Figure 44](#)).
4. Click the relevant Text Field, for example, Presentation (in this example, **Presentation** appears in the Object List).

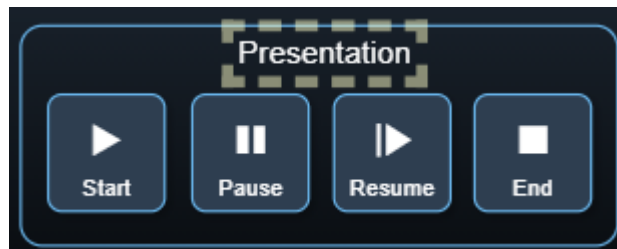

Figure 47: Edit Panel – Text Field Selected

The Properties (Text Field) and NewTextField Object list appear:

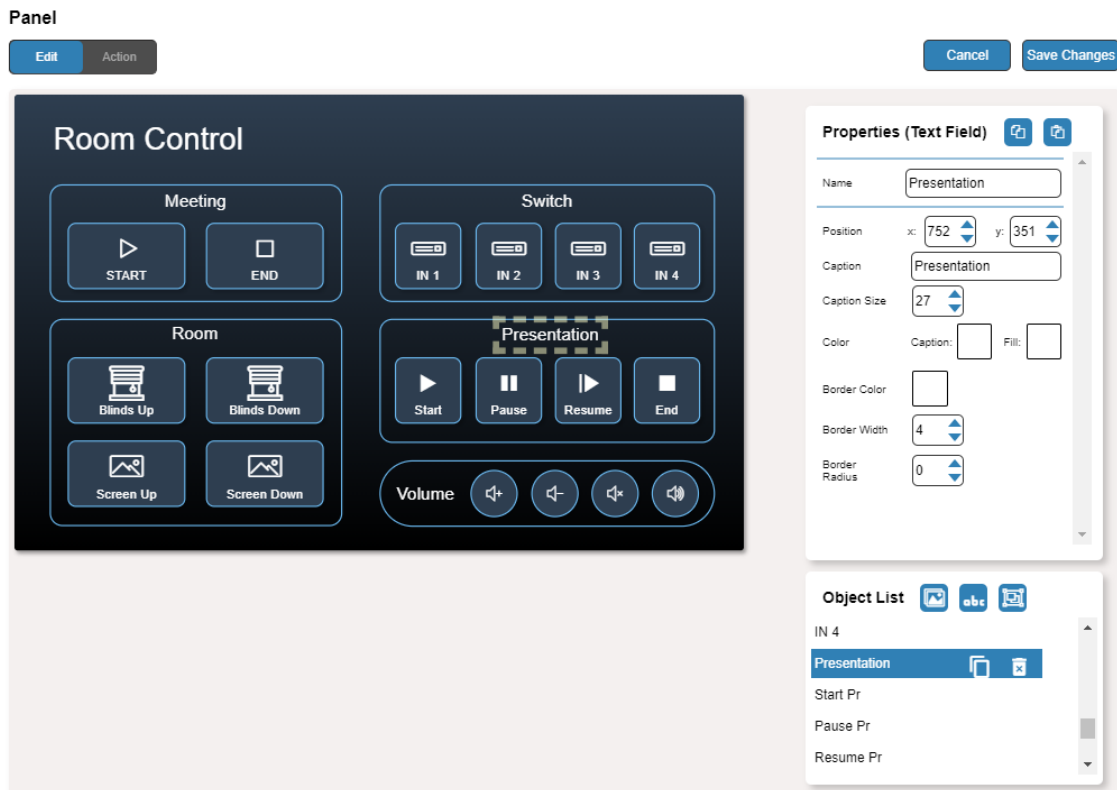





Figure 48: Edit Panel – Properties (Text Field) Area

5. Next to Presentation, do any of the following:
 - Click  next to duplicate the text field.
 - Click  to remove the text field.
6. In the Properties (Text Field) area, perform any of the following actions:
7. Perform any of the following actions:
 - Click  to copy the selected text field properties (Caption Size, Caption and Fill Color, Border Width and Color, and Border Radius).
 - Click  to paste button properties to a selected Text Field.
 - Change the text field name.
 - Set the position of the button by moving the button (or by entering the x, y position).
 - Enter the caption.
 - Enter Caption Size (or use up/down arrows).
 - Click the Caption and Fill colors to change them.
 - Change the button Icon and select its Color.
 - Click Border Color button to select border color.
 - Enter Border Width to change the border width (or use up/down arrows).
 - Enter Border Radius to change the border edge radius (or use up/down arrows).
8. Click **Save Changes**.

Presentation text field is configured.

Modifying a Frame

The default Maestro Control panel includes several frames (for example, the Video Frame) that can be modified via the Edit Panel tab.

To modify a frame:

1. In the Navigation pane, click **Automation**. The Automation page appears (see [Figure 39](#)).
2. Click the **Panel** tab. The **VS-411XS** Maestro Room Control panel appears (see [Figure 43](#)).
3. Click **Edit**. Edit Panel window appears (see [Figure 44](#)).
4. Click the relevant frame (in this example, **Switch Frame** appears in the Object List). Video frame is selected in the control panel.

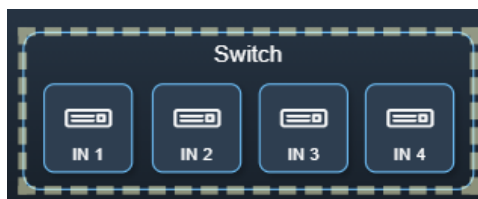

Figure 49: Edit Panel – Video Frame Selected

The Properties (Frame) and Video Frame Object list appear:

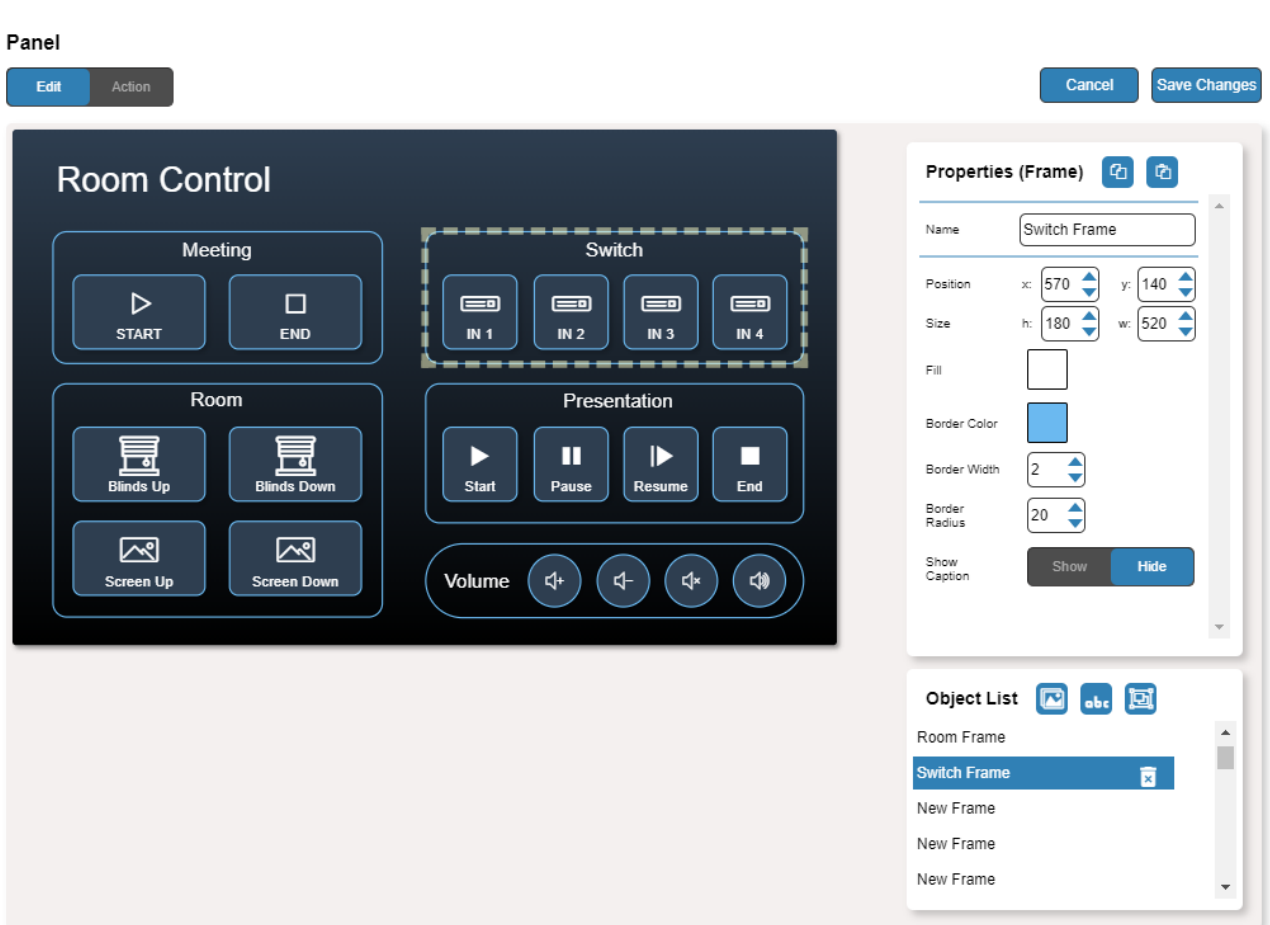





Figure 50: Edit Panel – Properties (Button) Area

5. Click  next to Video Frame to remove the frame from the panel.

6. In the Properties (Frame) area, perform any of the following actions:
 - Click  to copy the selected frame properties (Fill, Border Color, Border Width and Border Radius).
 - Click  to paste frame properties to a selected frame.
 - Change the frame Name.
 - Set the position of the frame by moving it (or by entering the x, y coordinates).
 - Enter frame size (or click Size up/down arrows to change h and w frame size).
 - Click the Fill color button to change the frame color.
 - Click the Border Color button to change the border color.
 - Enter Border Width to change the border width (or use up/down arrows).
 - Enter Border Radius to change the border edge radius (or use up/down arrows).
 - Click **Show/Hide** to show or hide the frame.
7. Click **Save Changes**.

The frame is configured.

Adding a New Button

The buttons in the Maestro Control panel are designed to carry out an assigned script to run when that button is pressed.

To add a new button:

1. In the Navigation pane, click **Automation**. The Automation page appears (see [Figure 39](#)).
2. Click the **Panel** tab. The default **VS-411XS** Maestro Control panel appears (see [Figure 43](#)).
3. Click **Edit**. The Edit panel appears (see [Figure 44](#)).

- Click  (add a button object) to add a new button to the panel. A new button is added to the top left side of the panel.

Panel

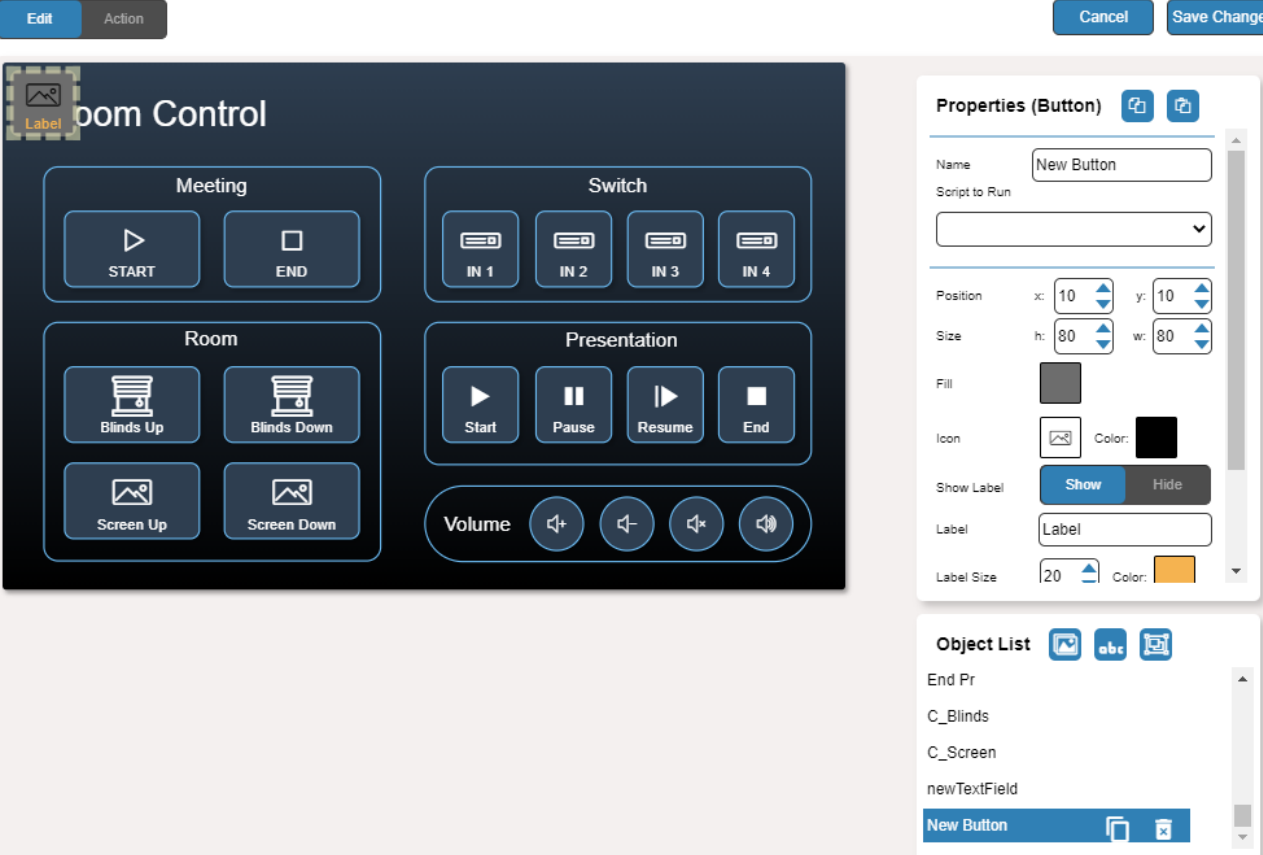

The screenshot shows the 'Panel' editor interface. On the left, a 'Room Control' panel is displayed with several sections: 'Meeting' (START, END), 'Switch' (IN 1, IN 2, IN 3, IN 4), 'Room' (Blinds Up, Blinds Down, Screen Up, Screen Down), 'Presentation' (Start, Pause, Resume, End), and 'Volume' (four volume control buttons). On the right, the 'Properties (Button)' panel is open, showing the 'Name' field set to 'New Button', a 'Script to Run' dropdown menu, and various styling options like Position, Size, Fill, Icon, Show Label, Label, and Label Size. Below the properties panel is the 'Object List' showing a list of available scripts, with 'New Button' highlighted at the bottom.

Figure 51: Adding a New Button

- Enter the button name. For example, use "Meeting Off" to turn off the devices in the room when a meeting ends.
- Assign a script (for example, **Restart**) to this button from the drop-down list.

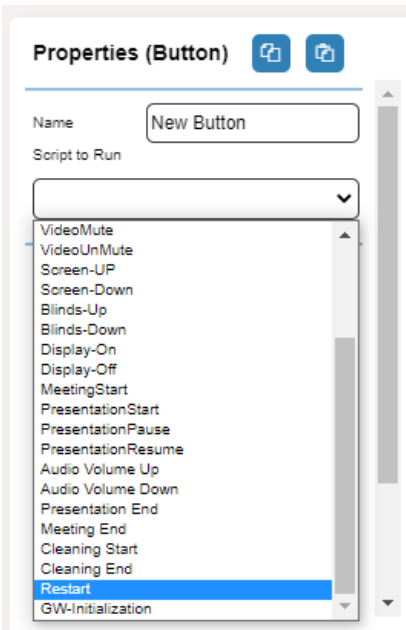

The screenshot shows the 'Properties (Button)' panel with the 'Script to Run' dropdown menu open. The list of scripts includes: VideoMute, VideoUnMute, Screen-UP, Screen-Down, Blinds-Up, Blinds-Down, Display-On, Display-Off, MeetingStart, PresentationStart, PresentationPause, PresentationResume, Audio Volume Up, Audio Volume Down, Presentation End, Meeting End, Cleaning Start, Cleaning End, **Restart**, and GW-Initialization. The 'Restart' script is highlighted in blue.

Figure 52: New Button – Assigning a Script

7. Design the button appearance by selecting the button:
 - Position and size.
 - Background fill.
 - Icon and icon color.
 8. Click **Show/Hide** to show or hide the button.
When showing the Caption, define label text, size, and color.
 9. Enter the Label, label size and color.
 10. Define the border width, color, and radius.
 11. Click **Save Changes**.
- A new button is added.

Adding a New Text Field

The Text Field in the Maestro Control panel is designed to give a title to a group of buttons.

To add a new text field:

1. In the Navigation pane, click **Automation**. The Automation page appears (see [Figure 39](#)).
2. Click the **Panel** tab. The default **VS-411XS** Maestro Control panel appears (see [Figure 43](#)).
3. Click **Edit**. The Edit panel appears (see [Figure 44](#)).

- Click  (add a text field) to add a new text field to the panel. A new text field is added to the top left side of the panel.

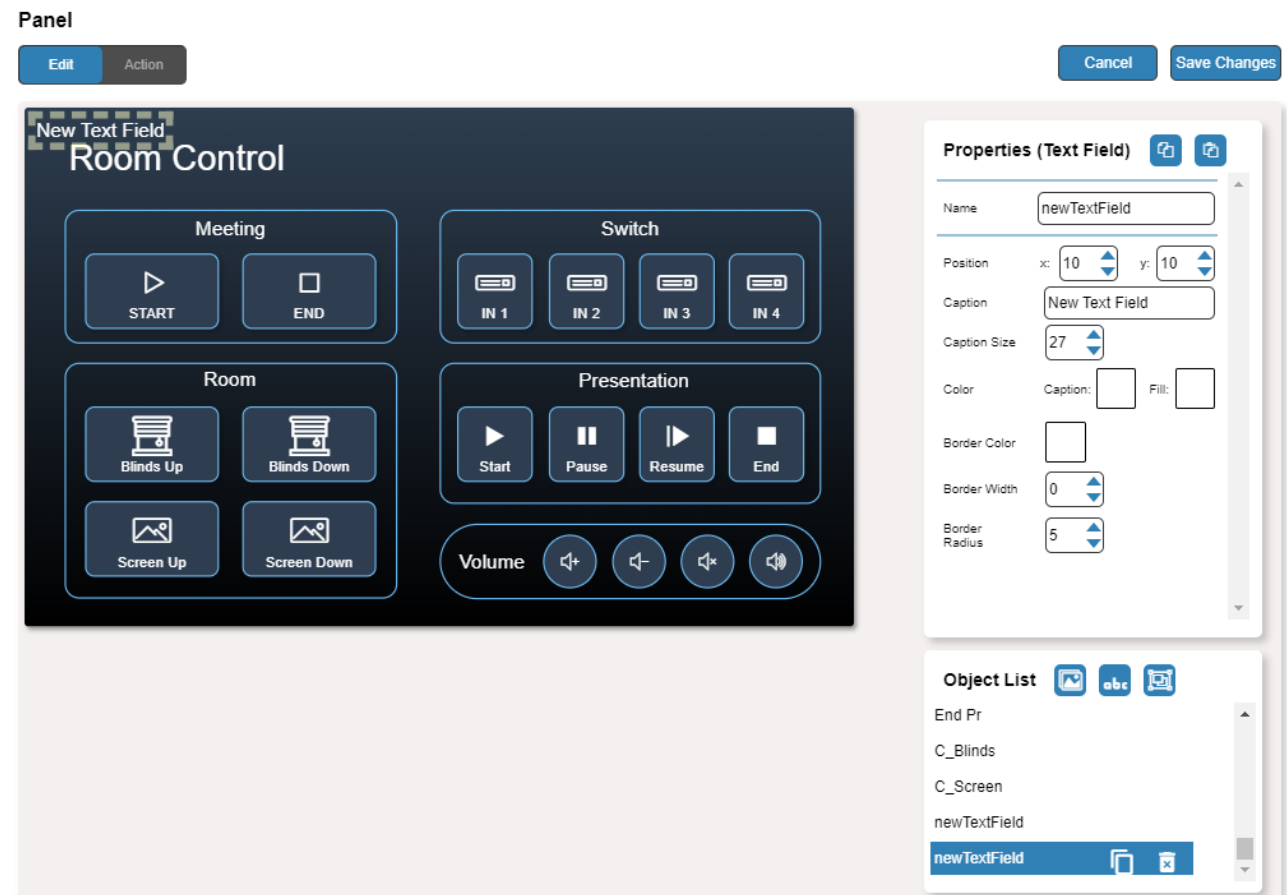

Figure 53: Adding a New Text Field

- Enter the text field name. For example, use “Meeting Space” to define meetings on/off area.
 - Enter the text caption.
 - Design the text field appearance by selecting its:
 - Position and size.
 - Caption color and background fill.
 - Border width, color and radius.
 - Click **Save Changes**.
- A new text field is added.

Adding a New Frame

The frame in the Maestro Control panel is designed to encircle a group of buttons.

To add a new frame:

- In the Navigation pane, click **Automation**. The Automation page appears (see [Figure 39](#)).
- Click the **Panel** tab. The default **VS-411XS** Maestro Control panel appears (see [Figure 43](#)).

3. Click **Edit**. The Edit panel appears (see [Figure 44](#)).
4. Click  (add a frame) to add a new frame to the panel. A new frame is added to the top left side of the panel.

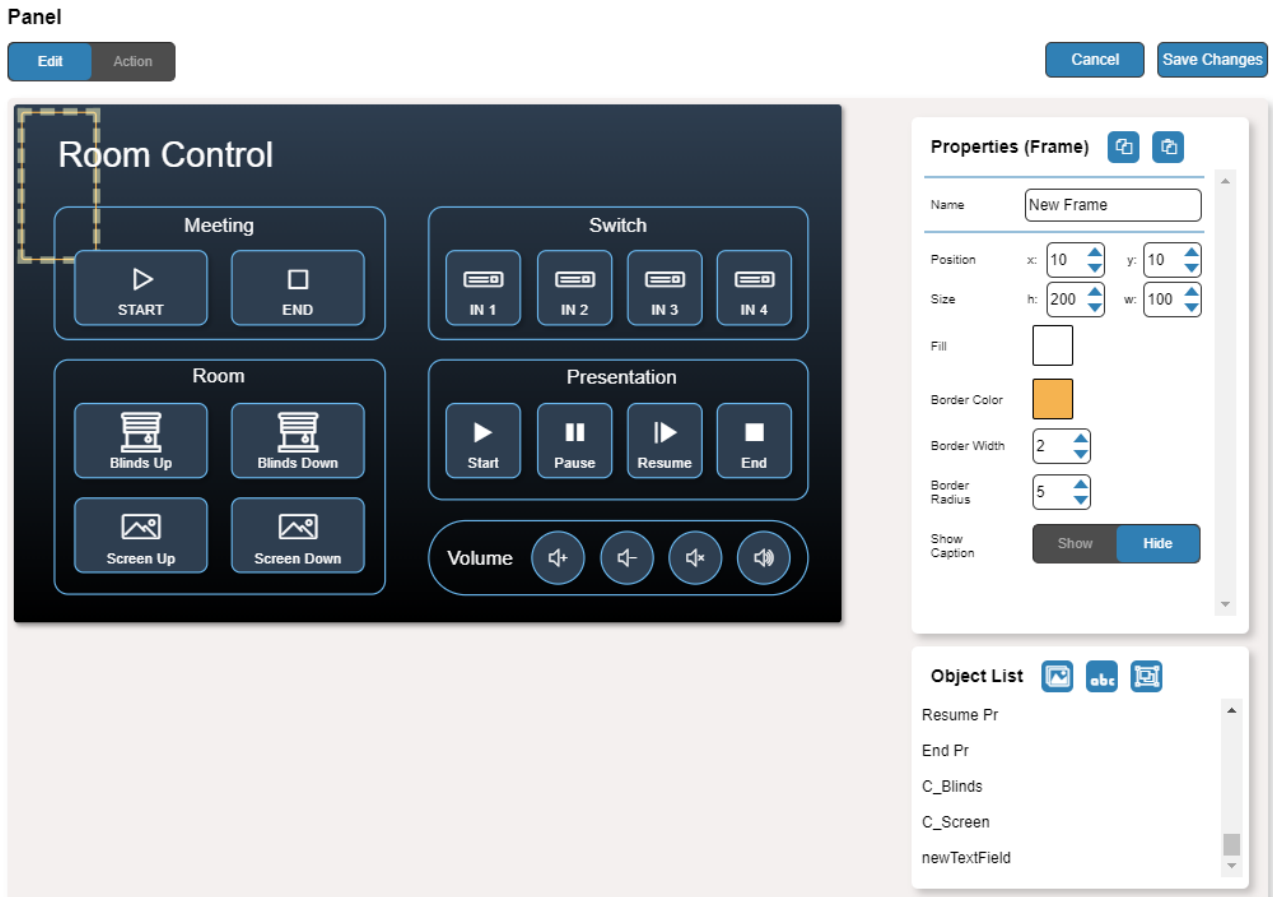

Figure 54: Adding a New Frame

5. Enter the frame name. For example, use “Meeting frame” to define meetings on/off area.
 6. Design the frame appearance by selecting its:
 - Position and size.
 - Border color and background fill.
 - Border width and radius.
 7. Click **Show/Hide** to show or hide the frame. When showing the Caption, define:
 - Caption text and size.
 - Caption text color, background color and border color.
 - Caption offset.
 8. Click **Save Changes**.
- A new frame is added.

Viewing About Page

View the Web page version and Kramer Electronics Ltd details in the About page.



Figure 55: The About Page

Firmware Upgrade

Use the Kramer **K-UPLOAD** software to upgrade the firmware via IP or RS-232, or use the embedded web pages (see [Upgrading the Firmware](#) on page 31).

The latest version of **K-UPLOAD** and installation instructions can be downloaded from our website at: www.kramerav.com/support/product_downloads.asp.



When upgrading the firmware via RS-232, we recommend that you temporarily disconnect from LAN.

Technical Specifications

Inputs	VS-211XS: 2 HDMI VS-411XS: 4 HDMI	On a female HDMI connector
Outputs	1 HDMI	On a female HDMI connector
	1 Balanced Stereo Line Level	On a 5-pin terminal block connector
Ports	1 RS-232	On a 3-pin terminal block
	Remote Contact Closure	On an 8-pin terminal block connector
	Ethernet	On an RJ-45 female connector
Video	Max Data Rate	17.82Gbps (5.94Gbps per graphic channel)
	Max Resolution	4@60Hz (4:4:4)
	Compliance	HDR10 as specified in HDMI 2.0, HDCP 2.2
Controls	Front Panel	SETUP DIP-switches
		Input selection, volume, and mute buttons
Indication LEDs	Front Panel	Input LEDs
		Mute LED
		Out LED
		On LED
Power	Consumption	5V DC, 810mA
	Source	5V DC, 4A
Environmental Conditions	Operating Temperature	0° to +40°C (32° to 104°F)
	Storage Temperature	-40° to +70°C (-40° to 158°F)
	Humidity	10% to 90%, RHL non-condensing
Regulatory Compliance	Safety	CE, UL
	Environmental	RoHs, WEEE
Enclosure	Size	DemiTOOLS
	Type	Aluminum
	Cooling	Convection Ventilation
General	Net Dimensions (W, D, H)	19cm x 6cm x 2.7cm (7.5" x 2.4" x 1.1")
	Shipping Dimensions (W, D, H)	34.5cm x 16.5cm x 5.2cm (13.6" x 6.5" x 2")
	Net Weight	0.32kg (0.7lbs) approx.
	Shipping Weight	0.79kg (1.7lbs) approx.
Accessories	Included	Power adapter and cord
Specifications are subject to change without notice at www.kramerav.com		

Default Communication Parameters

RS-232	
Baud Rate:	115,200
Data Bits:	8
Stop Bits:	1
Parity:	None
Command Format:	ASCII
#ROUTE 1,1,2<CR>	#ROUTE 1,1,2<CR>
IP (DHCP set to ON)	
Fallback IP Address:	192.168.1.39
Fallback Subnet Mask:	255.255.255.0
Fallback Gateway:	192.168.1.1
UDP Port #:	50000
TCP Port #:	5000
User/Password:	Admin/Admin
Full Factory Reset	
Web pages	Device Settings > General Settings > Factory reset This resets device parameters to their factory default values, excluding IP parameters
RESET button	Press briefly to restart the device. Press and hold (5 seconds) to fully reset the device parameters to their default values, including IP parameters.

Default Automation settings

Ports List

Port Name	Type	Port Properties	Port Description	Comments
WOL-Echo	WOL	7		
WOL-Discard	WOL	9		
Internal	Internal			Enabling actions on the device itself, such as switching an input.
CEC-TV	CEC	0		Enabling actions such as display on/off.
CEC-Broadcast	CEC	15		
Non-Serial-on-GW	TCP	192.168.1.40, 5000	Gateway Non-serial ports	For example, Relay, GPIO and IR control on the FC-28 gateway (optional, purchased separately).

Actions List

Action Name	Commands List	On Port	Comments
GW-IO1-Config	#GPIO-CFG 1,1,1,0	Non-Serial-on-GW	GPIO 1 => Blinds up/down
GW-IO1-Setup	#GPIO-STATE 1,0		GPIO1 initialize
GW-IO2-Config	#GPIO-CFG 2,1,1,0		GPIO 2 => For future use
GW-IO2-Setup	#GPIO-STATE 2,0		GPIO2 initialize
GW-Relay1-Setup	#RELAY-STATE 1,0		Relay 1 => Screen up/down
GW-Relay2-Setup	#RELAY-STATE 2,0		Relay 2 => For user

Action Name	Commands List	On Port	Comments
GW-Serial1-Setup	#UART 1,9600,8,0,1		Optional display control (in addition to CEC)
GW-Serial2-Setup	#UART 2,9600,8,0,1		Extra serial control
Switch-IN1	#ROUTE 1,1,1\x0D	Device-internal	
Switch-IN2	#ROUTE 1,1,2\x0D		
Switch-IN3	#ROUTE 1,1,3\x0D		VS-411XS only
Switch-IN4	#ROUTE 1,1,4\x0D		VS-411XS only
V-Out-Mute	#VMUTE 1,1\x0D		Display sleep
V-Out-Unmute	#VMUTE 1,0\x0D		Display wake-up
A-Out-Volume-Up	#AUD-LVL 1,1,++\x0D		Audio output port action
A-Out-Volume-Down	#AUD-LVL 1,1,--\x0D		
A-Out-Mute	#MUTE 1,1\x0D		
A-Out-Unmute	#MUTE 1,0\x0D		
Screen-Up	#RELAY-STATE 1,0		
Screen-Down	#RELAY-STATE 1,1		Non-Serial-on-GW
Blinds-Up	#GPIO-STATE 1,0		
Blinds-Down	#GPIO-STATE 1,1		
CEC-Power-On	0x04	CEC-TV	
CEC-Power-Off	0x36	CEC-Broadcast	
Notify-Restart	#ALERT ERROR,' Device has restarted'	Local serial port, Kramer Network TCP/UDP port	
Notify-MeetingStart	#ALERT OK,' Meeting has started'		
Notify-MeetingEnd	#ALERT OK,' Meeting has ended'		
Notify-PresentationStart	#ALERT OK,' Presentation has started'		
Notify-PresentationPause	#ALERT OK,' Presentation paused'		
Notify-PresentationResume	#ALERT OK,' Presentation resumed'		
Notify-PresentationEnd	#ALERT OK,' Presentation has ended'		
Notify-CleaningStart	#ALERT OK,' Room cleaning has started'		
Notify-CleaningEnd	#ALERT OK,' Room cleaning has ended'		

Scripts List

Script Name	Actions List	Relevant Ports	Comment
GW-Initialization	GW-IO1-Config GW-IO1-Setup GW-IO2-Config GW-IO2-Setup GW-Relay1-Setup GW-Relay2-Setup GW-Serial1-Setup GW-Serial2-Setup	Non-Serial-on-GW, Non-Serial-on-GW, Non-Serial-on-GW, Non-Serial-on-GW, Non-Serial-on-GW, Non-Serial-on-GW, Display-Serial1-on-GW, Serial2-on-GW	IR => Undefined, available for IR control
Switch IN1	Switch-IN1	Internal	Touch button
Switch IN2	Switch-IN2	Internal	Touch button
Switch IN3	Switch-IN3	Internal	Touch button
Switch IN4	Switch-IN4	Internal	Touch button
Screen Up	Screen-Up Wait 0sec	Non-Serial-on-GW, -	Touch button
Screen Down	Screen-Down Wait 0sec	Non-Serial-on-GW, -	Touch button
Blinds Up	Blinds-Up Wait 0sec	Non-Serial-on-GW, -	Touch button
Blinds Down	Blinds-Down Wait 0sec	Non-Serial-on-GW, -	Touch button
Display On	V-Out-Unmute Wait (0) CEC-Power-On	Internal, - CEC-TV	Trigger
Display Off	V-Out-Mute Wait (900) CEC-Power-Off	Internal, - CEC-Broadcast	Trigger
Restart	Wait 2sec V-Out-Mute A-Out-Mute Notify-Restart GW-IO1-Config GW-IO1-Setup GW-IO2-Config GW-IO2-Setup GW-Relay1-Setup GW-Relay2-Setup GW-Serial1-Setup GW-Serial2-Setup Wait 1sec CEC-Power-Off Screen-Up Blinds-Up Wait 0sec	- Internal, Internal, Internal, Non-Serial-on-GW, Non-Serial-on-GW, Non-Serial-on-GW, Non-Serial-on-GW, Non-Serial-on-GW, Non-Serial-on-GW, Non-Serial-on-GW, Display-Serial1-on-GW, Serial2-on-GW, - CEC-Broadcast, Non-Serial-on-GW, Non-Serial-on-GW, -	Trigger
Meeting Start	V-Out-Mute A-Out-Mute CEC-Power-Off Screen-Up Blinds-Up Notify-MeetingStart Wait 0sec	Internal, Internal, CEC-Broadcast, Non-Serial-on-GW, Non-Serial-on-GW, Internal, -	Remote-trigger & Touch button
Presentation Start	V-Out-Unmute A-Out-Unmute	Internal, Internal,	Trigger + Remote-trigger & Touch button

Script Name	Actions List	Relevant Ports	Comment
	CEC-Power-On Screen-Down Blinds-Down Notify-PresentationStart Wait 0sec	CEC-TV, Non-Serial-on-GW, Non-Serial-on-GW, Internal, -	
Presentation Pause	V-Out-Mute A-Out-Mute Notify-PresentationPause Wait 0sec	Internal, Internal, Internal, -	Trigger & Touch button
Presentation Resume	V-Out-Unmute A-Out-Unmute Notify-PresentationResume Wait 0sec	Internal, Internal, Internal, -	Touch button
Audio Volume Up	A-Out-Volume-Up	Internal	Touch button
Audio Volume Down	A-Out-Volume-Down	Internal	Touch button
Audio Mute	A-Out-Mute	Internal	Touch button
Audio Unmute	A-Out-Unmute	Internal	Touch button
Presentation End	V-Out-Mute A-Out-Mute CEC-Power-Off Screen-Up Blinds-Up Notify-PresentationEnd Wait 0sec	Internal, Internal, CEC-Broadcast, Non-Serial-on-GW, Non-Serial-on-GW, Internal, -	Remote-trigger & Touch button
Meeting End	V-Out-Mute A-Out-Mute CEC-Power-Off Screen-Up Blinds-Up Notify-MeetingEnd Wait 0sec	Internal, Internal, CEC-Broadcast, Non-Serial-on-GW, Non-Serial-on-GW, Internal, -	Remote-trigger + Schedule-trigger & Touch button
Cleaning Start	V-Out-Mute A-Out-Mute CEC-Power-Off Screen-Up Blinds-Up Notify-CleaningStart Wait 0sec	Internal, Internal, CEC-Broadcast, Non-Serial-on-GW, Non-Serial-on-GW, Internal, -	Remote-trigger
Cleaning End	V-Out-Mute A-Out-Mute CEC-Power-Off Screen-Up Blinds-Up Notify-CleaningEnd Wait 0sec	Internal, Internal, CEC-Broadcast, Non-Serial-on-GW, Non-Serial-on-GW, Internal, -	Remote-trigger

Triggers List

Trigger Name	Description	Triggered Script	Comment
Power On	Device powered on	Restart	This recommended trigger is NOT included in Maestro default settings to prevent undesired auto-triggering of its associated script. You may set the trigger accordingly upon device installation or later.  This script works well when the room is inactive (e.g. at night time, turning off active TVs), but may cause disruption when running during actual meetings.
First IN Plugged	1 st HDMI input connected	Presentation Start	First ON
Last IN Unplugged	Last HDMI input disconnected	Presentation Pause	Last Off
5V On (Input detected)	When input activity is detected	Display On	
5V Off (No input detected)	When "delay power off" timeout period expires with no input activity	Display Off	
Remote1 Press	1 st remote button pressed	Meeting Start	Button Press
Remote2 Press	2 nd remote button pressed	Presentation Start	Button Press
Remote3 Press	3 rd remote button pressed	Presentation End	Button Press
Remote4 Press	4 th remote button pressed	Meeting End	Button Press
Remote5 Press	5 th remote button pressed	Cleaning Start	Button Press
Remote6 Press	6 th remote button pressed	Cleaning End	Button Press
After Office Hours	Prescheduled event occurred	Meeting End	This recommended trigger is NOT included in Maestro default settings to prevent undesired auto-triggering of its associated script. You can set the trigger accordingly upon device installation or later, and customize the After Office Hours duration according to your needs. For example, set After Office Hours Day/Time scheduling to: Monday-to-Friday: 18:00 Saturday-Sunday: 00:00.

Default EDID

Model name..... VS-411X
 Manufacturer..... KMR
 Plug and Play ID..... KMR1200
 Serial number..... 295-883450100
 Manufacture date..... 2018, ISO week 255
 Filter driver..... None

 EDID revision..... 1.3
 Input signal type..... Digital
 Color bit depth..... Undefined

Display type..... Monochrome/grayscale
 Screen size..... 520 x 320 mm (24.0 in)
 Power management..... Standby, Suspend, Active off/sleep
 Extension blocs..... 1 (CEA-EXT)

 DDC/CI..... n/a

Color characteristics

Default color space..... Non-sRGB
 Display gamma..... 2.20
 Red chromaticity..... Rx 0.674 - Ry 0.319
 Green chromaticity..... Gx 0.188 - Gy 0.706
 Blue chromaticity..... Bx 0.148 - By 0.064
 White point (default).... Wx 0.313 - Wy 0.329
 Additional descriptors... None

Timing characteristics

Horizontal scan range.... 30-83kHz
 Vertical scan range..... 56-76Hz
 Video bandwidth..... 170MHz
 CVT standard..... Not supported
 GTF standard..... Not supported
 Additional descriptors... None
 Preferred timing..... Yes
 Native/preferred timing.. 1920x1080p at 60Hz (16:9)
 Modeline..... "1920x1080" 148.500 1920 2008 2052 2200 1080 1084 1089 1125 +hsync +vsync

Standard timings supported

720 x 400p at 70Hz - IBM VGA
 720 x 400p at 88Hz - IBM XGA2
 640 x 480p at 60Hz - IBM VGA
 640 x 480p at 67Hz - Apple Mac II
 640 x 480p at 72Hz - VESA
 640 x 480p at 75Hz - VESA
 800 x 600p at 56Hz - VESA
 800 x 600p at 60Hz - VESA
 800 x 600p at 72Hz - VESA
 800 x 600p at 75Hz - VESA
 832 x 624p at 75Hz - Apple Mac II
 1024 x 768i at 87Hz - IBM
 1024 x 768p at 60Hz - VESA
 1024 x 768p at 70Hz - VESA
 1024 x 768p at 75Hz - VESA
 1280 x 1024p at 75Hz - VESA
 1152 x 870p at 75Hz - Apple Mac II
 1280 x 1024p at 75Hz - VESA STD
 1280 x 1024p at 85Hz - VESA STD
 1600 x 1200p at 60Hz - VESA STD
 1024 x 768p at 85Hz - VESA STD
 800 x 600p at 85Hz - VESA STD
 640 x 480p at 85Hz - VESA STD
 1152 x 864p at 70Hz - VESA STD
 1280 x 960p at 60Hz - VESA STD

EIA/CEA-861 Information

Revision number..... 3
 IT underscan..... Supported
 Basic audio..... Supported
 YCbCr 4:4:4..... Not supported
 YCbCr 4:2:2..... Not supported
 Native formats..... 1
 Detailed timing #1..... 1920x1080p at 60Hz (16:10)
 Modeline..... "1920x1080" 148.500 1920 2008 2052 2200 1080 1084 1089 1125 +hsync +vsync
 Detailed timing #2..... 1920x1080i at 60Hz (16:10)
 Modeline..... "1920x1080" 74.250 1920 2008 2052 2200 1080 1084 1094 1124 interlace +hsync +vsync
 Detailed timing #3..... 1280x720p at 60Hz (16:10)
 Modeline..... "1280x720" 74.250 1280 1390 1430 1650 720 725 730 750 +hsync +vsync
 Detailed timing #4..... 720x480p at 60Hz (16:10)
 Modeline..... "720x480" 27.000 720 736 798 858 480 489 495 525 -hsync -vsync

CE audio data (formats supported)

LPCM 2-channel, 16/20/24 bit depths at 32/44/48 kHz

CE video identifiers (VICs) - timing/formats supported

1920 x 1080p at 60Hz - HDTV (16:9, 1:1) [Native]
 1920 x 1080i at 60Hz - HDTV (16:9, 1:1)
 1280 x 720p at 60Hz - HDTV (16:9, 1:1)
 720 x 480p at 60Hz - EDTV (16:9, 32:27)
 720 x 480p at 60Hz - EDTV (4:3, 8:9)
 720 x 480i at 60Hz - Doublescan (16:9, 32:27)
 720 x 576i at 50Hz - Doublescan (16:9, 64:45)
 640 x 480p at 60Hz - Default (4:3, 1:1)

Protocol 3000

Kramer devices can be operated using Kramer Protocol 3000 commands sent via serial or Ethernet ports.

Understanding Protocol 3000

Protocol 3000 commands are a sequence of ASCII letters, structured according to the following.

- **Command format:**

Prefix	Command Name	Constant (Space)	Parameter(s)	Suffix
#	Command	_	Parameter	<CR>

- **Feedback format:**

Prefix	Device ID	Constant	Command Name	Parameter(s)	Suffix
~	nn	@	Command	Parameter	<CR><LF>

- **Command parameters** – Multiple parameters must be separated by a comma (,). In addition, multiple parameters can be grouped as a single parameter using brackets ([and]).
- **Command chain separator character** – Multiple commands can be chained in the same string. Each command is delimited by a pipe character (|).
- **Parameters attributes** – Parameters may contain multiple attributes. Attributes are indicated with pointy brackets (<...>) and must be separated by a period (.).

The command framing varies according to how you interface with **VS-211XS**. The following figure displays how the # command is framed using terminal communication software (such as Hercules):

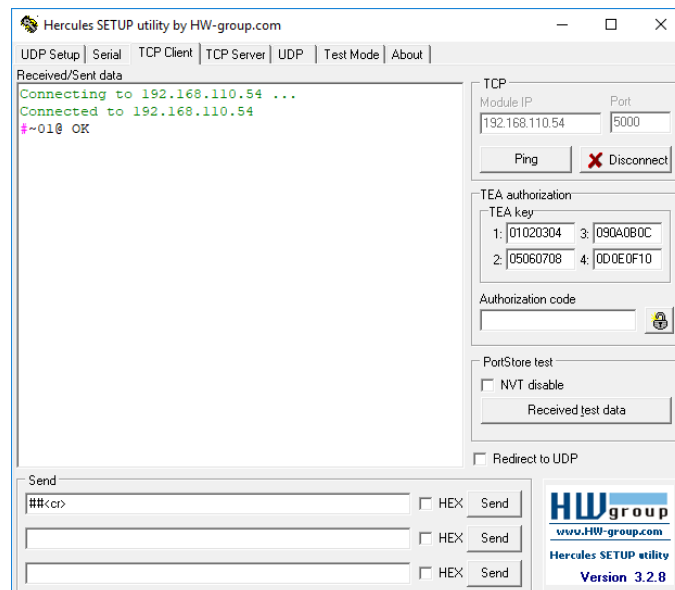

Protocol 3000 Commands

Function	Description	Syntax	Parameters/Attributes	Example
#	Protocol handshaking. ① Validates the Protocol 3000 connection and gets the machine number. Step-in master products use this command to identify the availability of a device.	COMMAND #<CR> FEEDBACK ~nn@_ok<CR><LF>		#<CR>
AUD-EMB?	Get audio in video embedding status.	COMMAND #AUD-EMB?_io_index,out_index<CR> FEEDBACK ~nn@AUD-EMB_io_index,out_index,emb_mode<CR><LF>	io_index – Number that indicates the specific input: 1-4 (or 1-2) out_index – Number that indicates the specific output: 1 emb_mode – Embedding status 0 – Analog 1 – Embedded 2 – Auto	Get audio embedded status of input 1: #AUD-EMB?_1,1<CR>
AUD-LVL	Set volume level.	COMMAND #AUD-LVL_io_mode,io_index,vol_level<CR> FEEDBACK ~nn@AUD-LVL_io_mode,io_index,vol_level<CR><LF>	io_mode – 1 – Output io_index – 1 vol_level – Volume level -96.0db to 12.0dB; ++ (increase current value by 0.5dB); -- (decrease current value by 0.5dB)	Set AUDIO OUT level to -50.0dB: #AUD-LVL_1,1,-50.0<CR>
AUD-LVL?	Get volume level.	COMMAND #AUD-LVL?_io_mode,io_index<CR> FEEDBACK ~nn@AUD-LVL_io_mode,io_index,vol_level<CR><LF>	io_mode – 1 – Output io_index – 1 vol_level – Volume level -96.0db to 12.0dB;	Get AUDIO OUT level: #AUD-LVL?_1,1<CR>
AUD-LVL-RANGE?	Get volume level min and max range.	COMMAND #AUD-LVL-RANGE?_io_mode,io_index<CR> FEEDBACK ~nn@AUD-LVL-RANGE_io_mode,io_index,min_val,max_val<CR><LF>	io_mode – 1 – Output io_index – 1 min_val – -96.0db max_val – 12.0dB	Get AUDIO OUT level range: #AUD-LVL-RANGE?_1,1<CR>
AUD-ONLY?	Get audio-only mode status	COMMAND #AUD-ONLY?_io_mode<CR> FEEDBACK ~nn@AUD-ONLY_io_mode,status<CR><LF>	io_mode – 1 – Output status – On/Off 0 – Off 1 – On	Get audio-only status: #AUD-ONLY?_1<CR>
AUD-SIGNAL?	Get audio input signal status.	COMMAND #AUD-SIGNAL?_in_index<CR> FEEDBACK ~nn@AUD-SIGNAL_in_index,status<CR><LF>	in_index – Number that indicates the specific input: 1-N (N= the total number of inputs) status – On/Off 0 – Off (no signal) 1 – On (signal present)	Get the status of input 1: #AUD-SIGNAL?_1<CR>
AUD-SIG-TYPE	Get audio-only mode status	COMMAND #AUD-SIG-TYPE_io_mode,io_index,sig_type<CR> FEEDBACK ~nn@AUD-SIG-TYPE_io_mode,io_index,sig_type<CR><LF>	io_mode – 0 – Input 1 – Output io_index – Number that indicates the specific input: 1-N (N= the total number of inputs) sig_type – On/Off 0 – AES 1 – Analog 2 – ARC	Set audio output signal type to ARC: #AUD-SIG-TYPE_1,1,2<CR>
AUD-SIG-TYPE?	Get audio-only mode status	COMMAND #AUD-SIG-TYPE?_io_mode,io_index<CR> FEEDBACK ~nn@AUD-SIG-TYPE_io_mode,io_index,sig_type<CR><LF>	io_mode – 0 – Input 1 – Output io_index – Number that indicates the specific input: 1-N (N= the total number of inputs) sig_type – On/Off 0 – AES 1 – Analog 2 – ARC	Get audio output signal type: #AUD-SIG-TYPE?_1,1<CR>
AV-SW-MODE?	Get input auto switch mode (per output).	COMMAND #AV-SW-MODE?_layer_type,out_index<CR> FEEDBACK ~nn@AV-SW-MODE_layer_type,out_index,connection_mode<CR><LF>	layer_type – Number that indicates the signal type: 1 – Video 2 – Audio out_index – 1 connection_mode – Connection mode 0 – manual 1 – priority switch 2 – last connected switch	Get the input audio switch mode for HDMI OUT: #AV-SW-MODE?_1,1<CR>
AV-SW-TIMEOUT	Set auto switching timeout.	COMMAND #AV-SW-TIMEOUT_switching_mode,time_out<CR> FEEDBACK ~nn@AV-SW-TIMEOUT_switching_mode,time_out<CR><LF>	switching_mode – Switching mode 0 – Video signal lost 4 – Disable 5V on video output if no input signal detected 5 – Video cable unplugged time_out – Timeout in seconds 0 – 60000	Set the auto switching timeout to 5 seconds in the event of 5V disable when no input signal is detected: #AV-SW-TIMEOUT_4,5<CR>

Function	Description	Syntax	Parameters/Attributes	Example
AV-SW-TIMEOUT?	Set auto switching timeout.	COMMAND #AV-SW-TIMEOUT?_switching_mode<CR> FEEDBACK ~nn@AV-SW-TIMEOUT_switching_mode,time_out<CR><LF>	switching_mode – Switching mode 0 – Video signal lost 4 – Disable 5V on video output if no input signal detected 5 – Video cable unplugged time_out – Timeout in seconds 0 - 60000	Get the auto switching timeout to for video signal loss: #AV-SW-TIMEOUT?_time_out<CR>
BEACON-INFO?	Get beacon information, including IP address, UDP control port, TCP control port, MAC address, model, name.	COMMAND #BEACON-INFO?_<CR> FEEDBACK ~nn@BEACON-INFO_port_id,ip_string,udp_port,tcp_port,mac_address,model,name<CR><LF>	port_id – ID of the Ethernet port ip_string – Dot-separated representation of the IP address udp_port – UDP control port tcp_port – TCP control port mac_address – Dash-separated mac address model – Device model name – Device name	Get beacon information: #BEACON-INFO?_<CR>
BUILD-DATE?	Get device build date.	COMMAND #BUILD-DATE?_<CR> FEEDBACK ~nn@BUILD-DATE_date,time<CR><LF>	date – Format: YYYY/MM/DD where YYYY = Year MM = Month DD = Day time – Format: hh:mm:ss where hh = hours mm = minutes ss = seconds	Get the device build date: #BUILD-DATE?<CR>
CEC-GW-PORT-ACTIVE	Set gateway port status.	COMMAND #CEC-GW-PORT-ACTIVE_port_ID,status<CR> FEEDBACK ~nn@CEC-GW-PORT-ACTIVE_port_ID,status<CR><LF>	Port_id – 1 status – 0 – Off 1 – On	Set the gateway port status to enable: #CEC-GW-PORT-ACTIVE_1,1<CR>
CEC-GW-PORT-ACTIVE?	Get gateway port status.	COMMAND #CEC-GW-PORT-ACTIVE?_port_ID<CR> FEEDBACK ~nn@CEC-GW-PORT-ACTIVE_port_ID,status<CR><LF>	Port_id – 1 status – 0 – Off 1 – On	Get the gateway port status: #CEC-GW-PORT-ACTIVE?_1<CR>
CEC-LOGIC-ADDR	Set device CEC logical address.	COMMAND #CEC-LOGIC-ADDR_port_index,la<CR> FEEDBACK ~nn@CEC-LOGIC-ADDR_port_index,la<CR><LF>	Port_index – 1 la – 1 to 15	Show device logic address: #CEC-LOGIC-ADDR_1.1<CR>
CEC-LOGIC-ADDR?	Get device CEC logical address.	COMMAND #CEC-LOGIC-ADDR?_port_index<CR> FEEDBACK ~nn@CEC-LOGIC-ADDR_port_index,la<CR><LF>	Port_index – 1 la – 1 to 15	Get device logic address: #CEC-LOGIC-ADDR?_out.hdmi.1<CR>
CEC-MEMBERS?	Get list of CEC logical addresses.	COMMAND #CEC-MEMBERS?_port_index<CR> FEEDBACK ~nn@CEC-MEMBERS_port_index,<la1>,<la2>...<CR><LF>	Port_index – 1 la – 1 to 15	Set gateway members: #CEC-MEMBERS?_1<CR>
CEC-NTFY	Notify about CEC command retrieved from bus. ⓘ Notification is sent to all com ports upon CEC message retrieval from CEC bus	COMMAND #CEC-NTFY_<CR> FEEDBACK ~nn@CEC-NTFY_port_num,len,<cec_command...><CR><LF>	port_num – 1 port notifying the command len – 1-16 cec_command – CEC format command (in HEX format, no leading zeros, no '0x' prefix)	Notify about CEC command retrieved from bus.: #CEC-NTFY<CR>
CEC-SND	Send CEC command to port.	COMMAND #CEC-SND_port_index,sn_id,cmd_name,cec_len,cec_command<CR> FEEDBACK ~nn@CEC-SND_port_index,sn_id,cmd_name,cec_mode<CR><LF>	port_index – CEC port transmitting the command (1 – number of ports) sn_id – serial number of command for flow control and response commands from device cmd_name – command name cec_len – 1-16 cec_command – CEC format command (in HEX format, no leading zeros, no '0x' prefix) cec_mode – CEC mode 0 – Sent 1 – Gateway disabled 2 – Inactive CEC-Master 3 – Busy 4 – Illegal Message Parameter 5 – Illegal CEC Address Parameter 6 – Illegal CEC Command 7 – Timeout 8 – Error	Send CEC command to port: #CEC-SND_1,1,1,1,1,1<CR>

Function	Description	Syntax	Parameters/Attributes	Example
CPEDID	<p>Copy EDID data from the output to the input EEPROM.</p> <p>i Destination bitmap size depends on device properties (for 64 inputs it is a 64-bit word).</p> <p>Example: bitmap 0x0013 means inputs 1,2 and 5 are loaded with the new EDID.</p> <p>In certain products Safe_mode is an optional parameter. See the HELP command for its availability.</p>	<p>COMMAND</p> <pre>#CPEDID_<edid_io>,<src_id>,<edid_io>,<dest_bitmap><CR></pre> <p>or</p> <pre>#CPEDID_<edid_io>,<src_id>,<edid_io>,<dest_bitmap>,<safe_mode><CR></pre> <p>FEEDBACK</p> <pre>~nn@CPEDID_<edid_io>,<src_id>,<edid_io>,<dest_bitmap><CR><LF></pre> <pre>~nn@CPEDID_<edid_io>,<src_id>,<edid_io>,<dest_bitmap>,<safe_mode><CR><LF></pre>	<p>edid_io – EDID source type (usually output)</p> <ul style="list-style-type: none"> 0– Input 1– Output 2– Default EDID 3– Custom EDID <p>src_id – Number of chosen source stage</p> <ul style="list-style-type: none"> 0– Default EDID source <p>For inputs</p> <ul style="list-style-type: none"> 0– Input 1 1– Input 2 2– Input 3 3– Input 4 <p>For output - 1</p> <p>For custom EDID -</p> <p>edid_io – EDID destination type (usually input)</p> <ul style="list-style-type: none"> 0– Input <p>dest_bitmap – Bitmap representing destination IDs. Format: XXXX...X, where X is hex digit. The binary form of every hex digit represents corresponding destinations.</p> <ul style="list-style-type: none"> 0– indicates that EDID data is not copied to this destination. 1– indicates that EDID data is copied to this destination. <p>safe_mode – Safe mode</p> <ul style="list-style-type: none"> 0– device accepts the EDID as is without trying to adjust 1– device tries to adjust the EDID (default value if no parameter is sent) 	<p>Copy the EDID data from the Output 1 (EDID source) to the Input:</p> <pre>#CPEDID_1,1,0,0x1<CR></pre> <p>Copy the EDID data from the default EDID source to the Input:</p> <pre>#CPEDID_2,0,0,0x1<CR></pre>
DISPLAY?	Get output HPD status.	<p>COMMAND</p> <pre>#DISPLAY?_<out_index><CR></pre> <p>FEEDBACK</p> <pre>~nn@DISPLAY_<out_index>,<status><CR><LF></pre>	<p>out_index – Number that indicates the specific output:</p> <ul style="list-style-type: none"> 1 <p>status – HPD status according to signal validation</p> <ul style="list-style-type: none"> 0– Signal or sink is not valid 1– Signal or sink is valid 2– Sink and EDID is valid 	Get the output HPD status of Output 1:
DPSW-STATUS?	Get the DIP-switch state.	<p>COMMAND</p> <pre>#DPSW-STATUS?_<dip_id><CR></pre> <p>FEEDBACK</p> <pre>~nn@DPSW-STATUS_<dip_id>,<status><CR><LF></pre>	<p>dip_id – 1 to 4 (number of DIP switches)</p> <p>status – Up/down</p> <ul style="list-style-type: none"> 0– Up 1– Down 	Get the DIP-switch 2 status:
EDID-DC	Force removal of deep color on EDID or leaving it as in the original EDID.	<p>COMMAND</p> <pre>#EDID-DC_<in_index>,<deep_color_state><CR></pre> <p>FEEDBACK</p> <pre>~nn@EDID-DC_<in_index>,<deep_color_state><CR><LF></pre>	<p>in_index – Number that indicates the specific input:</p> <ul style="list-style-type: none"> 1– Input 1 2– Input 2 3– Input 3 4– Input 4 <p>deep_color_state –</p> <ul style="list-style-type: none"> 0– Don't change 1– Remove deep color 	Remove deep color on EDID for input 1.
EDID-DC?	Get deep color status on EDID.	<p>COMMAND</p> <pre>#EDID-DC?_<in_index> <CR></pre> <p>FEEDBACK</p> <pre>~nn@EDID-DC_<in_index>,<deep_color_state><CR><LF></pre>	<p>in_index – Number that indicates the specific input:</p> <ul style="list-style-type: none"> 0– Input 1 1– Input 2 2– Input 3 3– Input 4 <p>deep_color_state –</p> <ul style="list-style-type: none"> 0– Don't change 1– Remove deep color 	Get deep color state on EDID for input 2.
ETH-PORT	Set Ethernet port protocol.	<p>COMMAND</p> <pre>#ETH-PORT_<port_type>,<port_id><CR></pre> <p>FEEDBACK</p> <pre>~nn@ETH-PORT_<port_type>,<port_id><CR><LF></pre>	<p>port_type – TCP/UDP</p> <p>port_id – TCP/UDP port number (0 – 65535)</p>	Set the Ethernet port protocol for TCP to 12457:
ETH-PORT?	Get Ethernet port protocol.	<p>COMMAND</p> <pre>#ETH-PORT?_<port_type><CR></pre> <p>FEEDBACK</p> <pre>~nn@ETH-PORT_<port_type>,<port_id><CR><LF></pre>	<p>port_type – TCP/UDP</p> <p>port_id – TCP/UDP port number (0 – 65535)</p>	Get the Ethernet port protocol for UDP:

Function	Description	Syntax	Parameters/Attributes	Example
FACTORY	<p>Reset device to factory default configuration.</p> <p>i This command deletes all user data from the device. The deletion can take some time.</p> <p>Your device may require powering off and powering on for the changes to take effect.</p>	<p>COMMAND</p> <pre>#FACTORY<CR></pre> <p>FEEDBACK</p> <pre>~nn@FACTORY_ok<CR><LF></pre>		<p>Reset the device to factory default configuration:</p> <pre>#FACTORY<CR></pre>
GEDID	<p>Get EDID support on certain input/output using an external application</p> <p>i For old devices that do not support this command, ~nm@ERR 002<CR><LF> is received.</p>	<p>COMMAND</p> <pre>#GEDID_io_mode,in_index<CR></pre> <p>FEEDBACK</p> <pre>~nn@GEDID_io_mode,in_index,size<CR><LF></pre>	<p>io_mode – Input/Output</p> <ul style="list-style-type: none"> 0– Input 1– Output 2– Default EDID 3– Custom EDID <p>in_index – Number that indicates the specific input:</p> <p>1-N (N= the total number of inputs)</p> <p>size – Size of data to be sent from device, 0 means no EDID support</p>	<p>Get EDID support information for input 1:</p> <pre>#GEDID_001<CR></pre>
HDCP-MOD	<p>Set HDCP mode.</p> <p>i Set HDCP working mode on the device input:</p> <p>HDCP supported - HDCP_ON [default].</p> <p>HDCP not supported - HDCP OFF.</p> <p>HDCP support changes following detected sink - MIRROR OUTPUT.</p> <p>When you define 3 as the mode, the HDCP status is defined according to the connected output in the following priority: OUT 1, OUT 2. If the connected display on OUT 2 supports HDCP, but OUT 1 does not, then HDCP is defined as not supported. If OUT 1 is not connected, then HDCP is defined by OUT 2.</p>	<p>COMMAND</p> <pre>#HDCP-MOD_in_index,mode<CR></pre> <p>FEEDBACK</p> <pre>~nn@HDCP-MOD_in_index,mode<CR><LF></pre>	<p>in_index – Number that indicates the specific input:</p> <p>1-N (N= the total number of inputs)</p> <p>mode – HDCP mode:</p> <ul style="list-style-type: none"> 0 – HDCP Off 3 – HDCP defined according to the connected output 	<p>Set the input HDCP-MODE of IN 1 to Off:</p> <pre>#HDCP-MOD_1,0<CR></pre>
HDCP-MOD?	<p>Set HDCP mode.</p> <p>i Set HDCP working mode on the device input:</p> <p>HDCP supported - HDCP_ON [default].</p> <p>HDCP not supported - HDCP OFF.</p> <p>HDCP support changes following detected sink - MIRROR OUTPUT.</p> <p>When you define 3 as the mode, the HDCP status is defined according to the connected output in the following priority: OUT 1, OUT 2. If the connected display on OUT 2 supports HDCP, but OUT 1 does not, then HDCP is defined as not supported. If OUT 1 is not connected, then HDCP is defined by OUT 2.</p>	<p>COMMAND</p> <pre>#HDCP-MOD?_in_index<CR></pre> <p>FEEDBACK</p> <pre>~nn@HDCP-MOD_in_index,mode<CR><LF></pre>	<p>in_index – Number that indicates the specific input:</p> <ul style="list-style-type: none"> 0– Input 1 1– Input 2 2– Input 3 3– Input 4 <p>mode – HDCP mode:</p> <ul style="list-style-type: none"> 0 – HDCP Off 3 – HDCP defined according to the connected output 	<p>Get the input HDCP-MODE of IN 2:</p> <pre>#HDCP-MOD?_2<CR></pre>
HDCP-OUT	<p>Set HDCP output mode.</p>	<p>COMMAND</p> <pre>#HDCP-OUT_out_index,mode<CR></pre> <p>FEEDBACK</p> <pre>~nn@HDCP-OUT_out_index,mode<CR><LF></pre>	<p>out_index – 1</p> <p>mode – HDCP mode:</p> <ul style="list-style-type: none"> 0 – Follow input 1 – Always on 	<p>Set the output HDCP-MODE to Follow Input:</p> <pre>#HDCP-MOD_1,0<CR></pre>

Function	Description	Syntax	Parameters/Attributes	Example										
HDCP-OUT?	Get HDCP output mode.	COMMAND #HDCP-OUT?_out_index<CR> FEEDBACK ~nn@HDCP-OUT_out_index,mode<CR><LF>	out_index – 1 mode – HDCP mode: 0 – Follow input 1 – Always on	Get the output HDCP-MODE: #HDCP-MOD?_1<CR>										
HDCP-STAT?	Get HDCP signal status. ① io_mode =1 – get the HDCP signal status of the sink device connected to the specified output. io_mode =0 – get the HDCP signal status of the source device connected to the specified input.	COMMAND #HDCP-STAT?_io_mode,in_index<CR> FEEDBACK ~nn@HDCP-STAT_io_mode,in_index,status<CR><LF>	io_mode – Input/Output 0 – Input 1 – Output io_index – Number that indicates the specific number of inputs or outputs (based on io_mode): For inputs: 0 – Input 1 1 – Input 2 2 – Input 3 3 – Input 4 For output: - 1 status – Signal encryption status - valid values On/Off 0 – HDCP Off 1 – HDCP On or HDCP 1.4 2 – HDCP 2.2	Get the output HDCP-STATUS of IN 1: #HDCP-STAT?_0,1<CR>										
HELP	Get command list or help for specific command.	COMMAND #HELP<CR> #HELP_cmd_name<CR> FEEDBACK 1. Multi-line: ~nn@Device_cmd_name,_cmd_name.<CR><LF> To get help for command use: HELP (COMMAND_NAME)<CR><LF> ~nn@HELP_cmd_name:<CR><LF> description<CR><LF> USAGE: usage<CR><LF>	cmd_name – Name of a specific command	Get the command list: #HELP<CR> To get help for AV-SW-TIMEOUT: HELP_av-sw-time out<CR>										
LDEDID	Write EDID data from external application to device. ① When the unit receives the LDEDID command it replies with READY and enters the special EDID packet wait mode. In this mode the unit can receive only packets and not regular protocol commands. If the unit does not receive correct packets for 30 seconds or is interrupted for more than 30 seconds before receiving all packets, it sends timeout error ~nn@LDEDID_err0 1<CR><LF> and returns to the regular protocol mode. If the unit received data that is not a correct packet, it sends the corresponding error and returns to the regular protocol mode.	COMMAND Multi-step syntax FEEDBACK Step 1: #LDEDID_edid_io,dest_bitmask,edid_size,safe_mode<CR> Response 1: ~nn@LDEDID_edid_io,dest_bitmask,edid_size,safe_mode_ready<CR><LF> or ~nn@LDEDID_errnr<CR><LF> Step 2: If ready was received, send EDID_DATA Response 2: ~nn@LDEDID_edid_io,dest_bitmask,edid_size,safe_mode_ok<CR><LF> or ~nn@LDEDID_errnr<CR><LF>	edid_io – EDID destination type (usually input) 0 – Input 1 – Output 2 – Default EDID 3 – Custom EDID dest_bitmask – Bitmap representing destination IDs. Format: 0x*****, where * is ASCII presentation of hex digit. The binary presentation of this number is a bit mask for destinations. Setting '1' means EDID data has to be copied to this destination edid_size – EDID data size safe_mode – Safe mode 0 – Device accepts the EDID as is without trying to adjust 1 – Device tries to adjust the EDID edid_data – Data in protocol packets Using the Packet Protocol Send a command: LDRV, LOAD, IROUT, LDEDID Receive Ready or ERR### If Ready: a. Send a packet, b. Receive OK on the last packet, c. Receive OK for the command Packet structure: Packet ID (1, 2, 3...) (2 bytes in length) Length (data length + 2 for CRC) – (2 bytes in length) Data (data length -2 bytes) CRC – 2 bytes <table border="1"><tr><td>01</td><td>02</td><td>03</td><td>04</td><td>05</td></tr><tr><td>Packet ID</td><td>Length</td><td>Data</td><td>CRC</td><td></td></tr></table> 5. Response: ~nnnn_ok<CR><LF> (Where NNNN is the received packet ID in ASCII hex digits.)	01	02	03	04	05	Packet ID	Length	Data	CRC		Write the EDID data from an external application to the HDMI In 1 input without adjustment attempts: #LDEDID_0,0x1,23 40,0<CR> Write the EDID data from an external application to HDMI In 1 and PC In inputs with adjustment attempts: #LDEDID_0,0x5,23 40,1<CR>
01	02	03	04	05										
Packet ID	Length	Data	CRC											
LOCK-EDID	Lock last read EDID.	COMMAND #LOCK-EDID_in_index,lock_mode<CR> FEEDBACK ~nn@LOCK-EDID_in_index,lock_mode<CR><LF>	in_index – Number that indicates the specific input: 1 – Input 1 2 – Input 2 3 – Input 3 4 – Input 4 lock_mode – On/Off 0 – Off unlocks EDID 1 – On locks EDID	Lock the last read EDID from input 2: #LOCK-EDID_2,1<CR>										
LOCK-EDID?	Get EDID Lock status.	COMMAND #LOCK-EDID?_in_index <CR> FEEDBACK ~nn@LOCK-EDID_in_index,lock_mode<CR><LF>	in_index – Number that indicates the specific input: 1 – Input 1 2 – Input 2 3 – Input 3 4 – Input 4 lock_mode – On/Off 0 – Off unlocks EDID 1 – On locks EDID	Get input 2 Lock EDID status: #LOCK-EDID?_2<CR>										

Function	Description	Syntax	Parameters/Attributes	Example
LOGIN	<p>Set protocol permission.</p> <p>i The permission system works only if security is enabled with the "SECUR" command.</p> <p>LOGIN allows the user to run commands with an End User or Administrator permission level. When the permission system is enabled, LOGIN enables running commands with the User or Administrator permission level. When set, login must be performed upon each connection.</p> <p>It is not mandatory to enable the permission system in order to use the device.</p> <p>In each device, some connections allow logging in to different levels. Some do not work with security at all.</p> <p>Connection may logout after timeout.</p>	<p>COMMAND</p> <pre>#LOGIN login_level,password<CR></pre> <p>FEEDBACK</p> <pre>~nn@LOGIN login_level,password_ok<CR><LF></pre> <p>or</p> <pre>~nn@LOGIN_err_004<CR><LF></pre> <p>(if bad password entered)</p>	<p>login_level – Level of permissions required (User or Admin)</p> <p>password – Predefined password (by PASS command). Default password is an empty string</p>	<p>Set the protocol permission level to Admin (when the password defined in the PASS command is 33333):</p> <pre>#LOGIN_admin,3333<CR></pre>
LOGIN?	<p>Get protocol permission state.</p> <p>i The permission system works only if security is enabled with the "SECUR" command.</p> <p>LOGIN allows the user to run commands with an End User or Administrator permission level. When the permission system is enabled, LOGIN enables running commands with the User or Administrator permission level. When set, login must be performed upon each connection.</p> <p>It is not mandatory to enable the permission system in order to use the device.</p> <p>In each device, some connections allow logging in to different levels. Some do not work with security at all.</p> <p>Connection may logout after timeout.</p>	<p>COMMAND</p> <pre>#LOGIN login_level <CR></pre> <p>FEEDBACK</p> <pre>~nn@LOGIN login_level,password_ok<CR><LF></pre> <p>or</p> <pre>~nn@LOGIN_err_004<CR><LF></pre> <p>(if bad password entered)</p>	<p>login_level – Level of permissions required (User or Admin)</p> <p>password – Predefined password (by PASS command). Default password is an empty string or NO SECURE if authentication is removed.</p>	<p>Get the protocol permission level to Admin:</p> <pre>#LOGIN_admin<CR></pre>
LOGOUT	<p>Cancel current permission level.</p> <p>i Logs out from End User or Administrator permission levels to Not Secure.</p>	<p>COMMAND</p> <pre>#LOGOUT<CR></pre> <p>FEEDBACK</p> <pre>~nn@LOGOUT_ok<CR><LF></pre>		<pre>#LOGOUT<CR></pre>

Function	Description	Syntax	Parameters/Attributes	Example
MODEL?	Get device model. <p>i This command identifies equipment connected to VS-211XS and notifies of identity changes to the connected equipment. The Matrix saves this data in memory to answer REMOTE-INFO requests.</p>	COMMAND #MODEL?_<CR> FEEDBACK ~nn@MODEL_<model_name><CR><LF>	model_name – String of up to 19 printable ASCII chars	Get the device model: #MODEL?_<CR>
MUTE	Set audio mute.	COMMAND #MUTE_<out_index>,<mute_mode><CR> FEEDBACK ~nn@MUTE_<out_index>,<mute_mode><CR><LF>	out_index –1 mute_mode – On/Off 0 – Off 1 – On	Set Output 1 to mute: #MUTE_1,1<CR>
MUTE?	Set audio mute.	COMMAND #MUTE_<out_index><CR> FEEDBACK ~nn@MUTE_<out_index>,<mute_mode><CR><LF>	out_index –1 mute_mode – On/Off 0 – Off 1 – On	Get Output 1 to mute: #MUTE_1,1<CR>
NAME	Set machine (DNS) name. <p>i The machine name is not the same as the model name. The machine name is used to identify a specific machine or a network in use (with DNS feature on).</p>	COMMAND #NAME_<machine_name><CR> FEEDBACK ~nn@NAME_<machine_name><CR><LF>	machine_name – String of up to 15 alpha-numeric chars (can include hyphen, not at the beginning or end)	Set the DNS name of the device to room-442: #NAME_<room-442><CR>
NAME?	Get machine (DNS) name. <p>i The machine name is not the same as the model name. The machine name is used to identify a specific machine or a network in use (with DNS feature on).</p>	COMMAND #NAME?_<CR> FEEDBACK ~nn@NAME_<machine_name><CR><LF>	machine_name – String of up to 15 alpha-numeric chars (can include hyphen, not at the beginning or end)	Get the DNS name of the device: #NAME?_<CR>
NAME-RST	Reset machine (DNS) name to factory default. <p>i Factory default of machine (DNS) name is "KRAMER_" + 4 last digits of device serial number.</p>	COMMAND #NAME-RST<CR> FEEDBACK ~nn@NAME-RST_<ok><CR><LF>		Reset the machine name (S/N last digits are 0102): #NAME-RST_<kramer_0102><CR>
NET-CONFIG	Set a network configuration. <p>i Parameters [DNS1] and [DNS2] are optional.</p> <p>i For Backward compatibility, the id parameter can be omitted. In this case, the Network ID, by default, is 0, which is the Ethernet control port.</p> <p>i If the gateway address is not compliant to the subnet mask used for the host IP, the command will return an error. Subnet and gateway compliancy specified by RFC950.</p>	COMMAND #NET-CONFIG_<netw_id>,<net_ip>,<net_mask>,<gateway>,[<dns1>],[<dns2><CR> FEEDBACK ~nn@NET-CONFIG_<netw_id>,<net_ip>,<net_mask>,<gateway><CR><LF>	netw_id –0 net_ip – Network IP net_mask – Network mask gateway – Network gateway	Set the device network parameters to IP address 192.168.113.10, net mask 255.255.0.0, and gateway 192.168.0.1: #NET-CONFIG_0,192.168.113.10,255.255.0.0,192.168.0.1<CR>

Function	Description	Syntax	Parameters/Attributes	Example
NET-CONFIG?	<p>Get a network configuration.</p> <p>i Parameters [DNS1] and [DNS2] are optional.</p> <p>i For Backward compatibility, the id parameter can be omitted. In this case, the Network ID, by default, is 0, which is the Ethernet control port.</p> <p>i If the gateway address is not compliant to the subnet mask used for the host IP, the command will return an error. Subnet and gateway compliancy specified by RFC950.</p>	<p>COMMAND</p> <pre>#NET-CONFIG _net_id,net_ip,net_mask,gateway, [dns1], [dns2] <CR></pre> <p>FEEDBACK</p> <pre>~nn@NET-CONFIG _net_id,net_ip,net_mask,gateway<CR><LF></pre>	<p>net_id – 0</p> <p>net_ip – Network IP</p> <p>net_mask – Network mask</p> <p>gateway – Network gateway</p>	<p>Get the device network parameters:</p> <pre>#NET-CONFIG?_0<CR></pre>
NET-DHCP	<p>Set DHCP mode.</p> <p>i Only 1 is relevant for the mode value. To disable DHCP, the user must configure a static IP address for the device.</p> <p>Connecting Ethernet to devices with DHCP may take more time in some networks.</p> <p>To connect with a randomly assigned IP by DHCP, specify the device DNS name (if available) using the NAME command. You can also get an assigned IP by direct connection to USB or RS-232 protocol port, if available.</p> <p>For proper settings consult your network administrator.</p> <p>i For Backward compatibility, the id parameter can be omitted. In this case, the Network ID, by default, is 0, which is the Ethernet control port.</p>	<p>COMMAND</p> <pre>#NET-DHCP _net_id,dhcp_state<CR></pre> <p>FEEDBACK</p> <pre>~nn@NET-DHCP _net_id,dhcp_state<CR><LF></pre>	<p>net_id – Network ID—the device network interface (if there are more than one). Counting is 0 based, meaning the control port is '0', additional ports are 1,2,3....</p> <p>dhcp_state –</p> <ul style="list-style-type: none"> 0– Do not use DHCP. Use the IP set by the factory or using the net-ip or net-config command. 1– Try to use DHCP. If unavailable, use the IP set by the factory or using the net-ip or net-config command. 	<p>Enable DHCP mode for port 1, if available:</p> <pre>#NET-DHCP _1,1<CR></pre>
NET-DHCP?	<p>Get DHCP mode.</p> <p>i For Backward compatibility, the id parameter can be omitted. In this case, the Network ID, by default, is 0, which is the Ethernet control port.</p>	<p>COMMAND</p> <pre>#NET-DHCP? _net_id<CR></pre> <p>FEEDBACK</p> <pre>~nn@NET-DHCP _net_id,dhcp_state<CR><LF></pre>	<p>net_id – Network ID—the device network interface (if there are more than one). Counting is 0 based, meaning the control port is '0', additional ports are 1,2,3....</p> <p>dhcp_state –</p> <ul style="list-style-type: none"> 0– Do not use DHCP. Use the IP set by the factory or using the net-ip or net-config command. 1– Try to use DHCP. If unavailable, use the IP set by the factory or using the net-ip or net-config command. 	<p>Get DHCP mode for port 1:</p> <pre>#NET-DHCP? _1<CR></pre>
NET-GATE	<p>Set gateway IP.</p> <p>i A network gateway connects the device via another network and maybe over the Internet. Be careful of security issues. For proper settings consult your network administrator.</p>	<p>COMMAND</p> <pre>#NET-GATE _ip_address<CR></pre> <p>FEEDBACK</p> <pre>~nn@NET-GATE _ip_address<CR><LF></pre>	<p>ip_address – Format: xxx.xxx.xxx.xxx</p>	<p>Set the gateway IP address to 192.168.0.1:</p> <pre>#NET-GATE _192.168.0.001<CR></pre>
NET-GATE?	<p>Get gateway IP.</p> <p>i A network gateway connects the device via another network and maybe over the Internet. Be aware of security problems.</p>	<p>COMMAND</p> <pre>#NET-GATE? _<CR></pre> <p>FEEDBACK</p> <pre>~nn@NET-GATE _ip_address<CR><LF></pre>	<p>ip_address – Format: xxx.xxx.xxx.xxx</p>	<p>Get the gateway IP address:</p> <pre>#NET-GATE? _<CR></pre>

Function	Description	Syntax	Parameters/Attributes	Example
NET-IP	Set IP address. ⓘ For proper settings consult your network administrator.	COMMAND #NET-IP_ip_address<CR> FEEDBACK ~nn@NET-IP_ip_address<CR><LF>	ip_address – Format: xxx.xxx.xxx.xxx	Set the IP address to 192.168.1.39: #NET-IP_192.168.001.039<CR>
NET-IP?	Get IP address.	COMMAND #NET-IP?_<CR> FEEDBACK ~nn@NET-IP_ip_address<CR><LF>	ip_address – Format: xxx.xxx.xxx.xxx	Get the IP address: #NET-IP?_<CR>
NET-MAC?	Get MAC address. ⓘ For backward compatibility, the id parameter can be omitted. In this case, the Network ID, by default, is 0, which is the Ethernet control port.	COMMAND #NET-MAC?_id<CR> FEEDBACK ~nn@NET-MAC_id,mac_address<CR><LF>	id – Network ID—the device network interface (if there are more than one). Counting is 0 based, meaning the control port is '0', additional ports are 1,2,3... mac_address – Unique MAC address. Format: XX-XX-XX-XX-XX-XX where X is hex digit	#NET-MAC?_id<CR>
NET-MASK	Set subnet mask. ⓘ For proper settings consult your network administrator.	COMMAND #NET-MASK_net_mask<CR> FEEDBACK ~nn@NET-MASK_net_mask<CR><LF>	net_mask – Format: xxx.xxx.xxx.xxx	Set the subnet mask to 255.255.0.0: #NET-MASK_255.255.000.000<CR>
NET-MASK?	Get subnet mask.	COMMAND #NET-MASK?_<CR> FEEDBACK ~nn@NET-MASK_net_mask<CR><LF>	net_mask – Format: xxx.xxx.xxx.xxx	Get the subnet mask: #NET-MASK?<CR>
PASS	Set password for login level. ⓘ The default password is an empty string.	COMMAND #PASS_login_level,password<CR> FEEDBACK ~nn@PASS_login_level,password<CR><LF>	login_level – Level of login to set (End User or Administrator). password – Password for the login_level. Up to 15 printable ASCII chars	Set the password for the Admin protocol permission level to 33333: #PASS_admin,33333<CR>
PASS?	Get password for login level. ⓘ The default password is an empty string.	COMMAND #PASS_login_level <CR> FEEDBACK ~nn@PASS_login_level,password<CR><LF>	login_level – Level of login to set (End User or Administrator). password – Password for the login_level. Up to 15 printable ASCII chars	Get the password for the Admin protocol permission: #PASS?_admin<CR>
PRIORITY	Set input priority. ⓘ WP-577VH – layer parameter is not used.	COMMAND #PRIORITY_layer_type,priority_1,priority_2..priority_4<CR> FEEDBACK ~nn@PRIORITY_layer_type,priority_1,priority_2..priority_4<CR><LF>	layer_type – Layer Enumeration 1 – Video priority – Priority of inputs (1-4)	Set the video input priority with input 2 as the highest priority: #PRIORITY_1,2,3,1,4<CR>
PRIORITY?	Set input priority.	COMMAND #PRIORITY?_layer_type<CR> FEEDBACK ~nn@PRIORITY_layer_type,priority_1,priority_2..priority_4<CR><LF>	layer_type – Layer Enumeration 1 – Video priority – Priority of inputs (1-4)	Set the video input priority with input 2 as the highest priority: #PRIORITY?_1<CR>
PROG-BTN-MOD	Set programmable buttons mode.	COMMAND #PROG-BUTTON-MOD_mode<CR> FEEDBACK ~nn@PROG-BUTTON-MOD_mode<CR><LF>	mode – 0 – Default behavior 1 – Programmable	Set the buttons to programmable mode: #PROG-BTN-MOD_1<CR>
PROG-BTN-MOD?	Set programmable buttons mode.	COMMAND #PROG-BUTTON-MOD?_<CR> FEEDBACK ~nn@PROG-BUTTON-MOD_mode<CR><LF>	mode – 0 – Default behavior 1 – Programmable	Get the buttons to programmable mode: #PROG-BTN-MOD?_<CR>
PROT-VER?	Get device protocol version.	COMMAND #PROT-VER?_<CR> FEEDBACK ~nn@PROT-VER_3000:version<CR><LF>	version – XX.XX where X is a decimal digit	Get the device protocol version: #PROT-VER?_<CR>
RESET	Reset device. ⓘ To avoid locking the port due to a USB bug in Windows, disconnect USB connections immediately after running this command. If the port was locked, disconnect and reconnect the cable to reopen the port.	COMMAND #RESET<CR> FEEDBACK ~nn@RESET_ok<CR><LF>		Reset the device: #RESET<CR>
ROUTE	Set layer routing. ⓘ This command replaces all other routing commands.	COMMAND #ROUTE_layer_type,out_index,in_index<CR> FEEDBACK ~nn@ROUTE_layer_type,out_index,in_index<CR><LF>	layer_type Layer Enumeration 1 – Video out_index 1 – Output in_index – Source id 1 – Input 1 2 – Input 2 3 – Input 3 4 – Input 4	Route video input 2 to the output: #ROUTE_1,1,2<CR>

Function	Description	Syntax	Parameters/Attributes	Example
ROUTE?	Get layer routing state. ⓘ This command replaces all other routing commands.	COMMAND #ROUTE?_layer_type,out_index<CR> FEEDBACK ~nn@ROUTE_layer_type,out_index,in_index <CR><LF>	layer_type – Layer Enumeration 1– Video out_index 1– OUT 1 HDMI in_index – Source id 1– Input 1 2– Input 2 3– Input 3 4– Input 4	Get video routing output: #ROUTE?_1,1<CR>
SECUR	Start/stop security. ⓘ The permission system works only if security is enabled with the "SECUR" command.	COMMAND #SECUR_security_state<CR> FEEDBACK ~nn@SECUR_security_state<CR><LF>	security_state – Security state 0– OFF (disables security) 1– ON (enables security)	Enable the permission system: #SECUR_1<CR>
SECUR?	Get security state. ⓘ The permission system works only if security is enabled with the "SECUR" command.	COMMAND #SECUR?_security_state<CR> FEEDBACK ~nn@SECUR_security_state<CR><LF>	security_state – Security state 0– OFF (disables security) 1– ON (enables security)	Enable the permission system: #SECUR?_<CR>
SIGNAL?	Get input signal status.	COMMAND #SIGNAL?_in_index<CR> FEEDBACK ~nn@SIGNAL_in_index,status<CR><LF>	in_index – Number that indicates the specific input: 1-N (N= the total number of inputs) status – Signal status according to signal validation: 0– Off 1– On	Get the input signal lock status of IN 1: #SIGNAL?_1<CR>
SN?	Get device serial number.	COMMAND #SN?_<CR> FEEDBACK ~nn@SN_serial_num<CR><LF>	serial_num – 14 decimal digits, factory assigned	Get the device serial number: #SN?_<CR>
TIME	Set device time and date. ⓘ The year must be 4 digits. The device does not validate the day of week from the date. Time format - 24 hours. Date format - Day, Month, Year.	COMMAND #TIME_day_of_week,date,data<CR> FEEDBACK ~nn@TIME_day_of_week,date,data<CR><LF>	day_of_week – One of {SUN,MON,TUE,WED,THU,FRI,SAT} date – Format: DD-MM-YYYY. data – Format: hh:mm:ss where hh = hours mm = minutes ss = seconds	Set device time and date to December 5, 2018 at 2:30pm: #TIME_mon_05-12-2018,14:30:00<CR>
TIME?	Get device time and date. ⓘ The year must be 4 digits. The device does not validate the day of week from the date. Time format - 24 hours. Date format - Day, Month, Year.	COMMAND #TIME?_<CR> FEEDBACK ~nn@TIME_day_of_week,date,data<CR><LF>	day_of_week – One of {SUN,MON,TUE,WED,THU,FRI,SAT} date – Format: YYYY/MM/DD where YYYY = Year MM = Month DD = Day data – Format: hh:mm:ss where hh = hours mm = minutes ss = seconds	Get device time and date: #TIME?<CR>
TIME-LOC	Set local time offset from UTC/GMT. ⓘ If the time server is configured, device time calculates by adding UTC_off to UTC time (that it got from the time server) + 1 hour if daylight savings time is in effect. TIME command sets the device time without considering these settings.	COMMAND #TIME-LOC_utc_off,dst_state<CR> FEEDBACK ~nn@TIME-LOC_utc_off,dst_state<CR><LF>	utc_off – Offset of device time from UTC/GMT (without daylight time correction) dst_state – Daylight saving time state 0– no daylight saving time 1– daylight saving time	Set local time offset to 3 with no daylight-saving time: #TIME-LOC_3,0<CR>
TIME-LOC?	Get local time offset from UTC/GMT. ⓘ If the time server is configured, device time calculates by adding UTC_off to UTC time (that it got from the time server) + 1 hour if daylight savings time is in effect. TIME command sets the device time without considering these settings.	COMMAND #TIME-LOC?_<CR> FEEDBACK ~nn@TIME-LOC_utc_off,dst_state<CR><LF>	utc_off – Offset of device time from UTC/GMT (without daylight time correction) dst_state – Daylight saving time state 0– no daylight saving time 1– daylight saving time	Get local time offset from UTC/GMT: #TIME-LOC?<CR>

Function	Description	Syntax	Parameters/Attributes	Example
TIME-SRV	Set time server. ⓘ This command is needed for setting UDP timeout for the current client list.	COMMAND #TIME-SRV_mode,time_server_ip, sync_hour<CR> FEEDBACK ~nn@TIME-SRV_mode,time_server_ip, sync_hour, server_status<CR><LF>	mode – On/Off 0– Off 1– On time_server_ip – Time server IP address sync_hour – Hour in day for time server sync server_status – On/Off	Set time server with IP address of 128.138.140.44 to ON: #TIME-SRV_1,128.138.140.44,0,1<CR>
TIME-SRV?	Get time server. ⓘ This command is needed for setting UDP timeout for the current client list.	COMMAND #TIME-SRV?_<CR> FEEDBACK ~nn@TIME-SRV_mode,time_server_ip, sync_hour, server_status<CR><LF>	mode – On/Off 0– Off 1– On time_server_ip – Time server IP address sync_hour – Hour in day for time server sync server_status – On/Off	Get time server: #TIME-SRV?<CR>
VERSION?	Get firmware version number.	COMMAND #VERSION?_<CR> FEEDBACK ~nn@VERSION_firmware_version<CR><LF>	firmware_version – XX.XX.XXXX where the digit groups are: major.minor.build version	Get the device firmware version number: #VERSION?_<CR>
VMUTE	Set enable/disable video on output. ⓘ Video mute parameter 2 (blank picture) is not supported.	COMMAND #VMUTE_out_index,flag<CR> FEEDBACK ~nn@VMUTE_out_index,flag<CR><LF>	out_index – Number that indicates the specific output: 1-N (N= the total number of outputs) flag – Video Mute 0– Video enabled 1– Video disabled 2– Blank picture	Disable the video output on OUT 2: #VMUTE_2,0<CR>
VMUTE?	Get video on output status. ⓘ Video mute parameter 2 (blank picture) is not supported.	COMMAND #VMUTE?_out_index<CR> FEEDBACK ~nn@VMUTE_out_index,flag<CR><LF>	out_index – Number that indicates the specific output: 1-N (N= the total number of outputs) flag – Video Mute 0– Video enabled 1– Video disabled 2– Blank picture	Get video on output status: #VMUTE?_2<CR>

Result and Error Codes

Syntax

In case of an error, the device responds with an error message. The error message syntax:

- **~NN@ERR XXX<CR><LF>** – when general error, no specific command
- **~NN@CMD ERR XXX<CR><LF>** – for specific command
- **NN** – machine number of device, default = 01
- **XXX** – error code

Error Codes

Error Name	Error Code	Description
P3K_NO_ERROR	0	No error
ERR_PROTOCOL_SYNTAX	1	Protocol syntax
ERR_COMMAND_NOT_AVAILABLE	2	Command not available
ERR_PARAMETER_OUT_OF_RANGE	3	Parameter out of range
ERR_UNAUTHORIZED_ACCESS	4	Unauthorized access
ERR_INTERNAL_FW_ERROR	5	Internal FW error
ERR_BUSY	6	Protocol busy
ERR_WRONG_CRC	7	Wrong CRC
ERR_TIMEDOUT	8	Timeout
ERR_RESERVED	9	(Reserved)
ERR_FW_NOT_ENOUGH_SPACE	10	Not enough space for data (firmware, FPGA...)
ERR_FS_NOT_ENOUGH_SPACE	11	Not enough space – file system
ERR_FS_FILE_NOT_EXISTS	12	File does not exist
ERR_FS_FILE_CANT_CREATED	13	File can't be created
ERR_FS_FILE_CANT_OPEN	14	File can't open
ERR_FEATURE_NOT_SUPPORTED	15	Feature is not supported
ERR_RESERVED_2	16	(Reserved)
ERR_RESERVED_3	17	(Reserved)
ERR_RESERVED_4	18	(Reserved)
ERR_RESERVED_5	19	(Reserved)
ERR_RESERVED_6	20	(Reserved)
ERR_PACKET_CRC	21	Packet CRC error
ERR_PACKET_MISSED	22	Packet number isn't expected (missing packet)
ERR_PACKET_SIZE	23	Packet size is wrong
ERR_RESERVED_7	24	(Reserved)
ERR_RESERVED_8	25	(Reserved)
ERR_RESERVED_9	26	(Reserved)
ERR_RESERVED_10	27	(Reserved)
ERR_RESERVED_11	28	(Reserved)
ERR_RESERVED_12	29	(Reserved)
ERR_EDID_CORRUPTED	30	EDID corrupted
ERR_NON_LISTED	31	Device specific errors
ERR_SAME_CRC	32	File has the same CRC – no changed
ERR_WRONG_MODE	33	Wrong operation mode
ERR_NOT_CONFIGURED	34	Device/chip was not initialized

The warranty obligations of Kramer Electronics Inc. ("Kramer Electronics") for this product are limited to the terms set forth below:

What is Covered

This limited warranty covers defects in materials and workmanship in this product.

What is Not Covered

This limited warranty does not cover any damage, deterioration or malfunction resulting from any alteration, modification, improper or unreasonable use or maintenance, misuse, abuse, accident, neglect, exposure to excess moisture, fire, improper packing and shipping (such claims must be presented to the carrier), lightning, power surges, or other acts of nature. This limited warranty does not cover any damage, deterioration or malfunction resulting from the installation or removal of this product from any installation, any unauthorized tampering with this product, any repairs attempted by anyone unauthorized by Kramer Electronics to make such repairs, or any other cause which does not relate directly to a defect in materials and/or workmanship of this product. This limited warranty does not cover cartons, equipment enclosures, cables or accessories used in conjunction with this product.

Without limiting any other exclusion herein, Kramer Electronics does not warrant that the product covered hereby, including, without limitation, the technology and/or integrated circuit(s) included in the product, will not become obsolete or that such items are or will remain compatible with any other product or technology with which the product may be used.

How Long this Coverage Lasts

The standard limited warranty for Kramer products is seven (7) years from the date of original purchase, with the following exceptions:

1. All Kramer VIA hardware products are covered by a standard three (3) year warranty for the VIA hardware and a standard three (3) year warranty for firmware and software updates; all Kramer VIA accessories, adapters, tags, and dongles are covered by a standard one (1) year warranty.
2. Kramer fiber optic cables, adapter-size fiber optic extenders, pluggable optical modules, active cables, cable retractors, ring mounted adapters, portable power chargers, Kramer speakers, and Kramer touch panels are covered by a standard one (1) year warranty. Kramer 7-inch touch panels purchased on or after April 1st, 2020 are covered by a standard two (2) year warranty.
3. All Kramer Calibre products, all Kramer Minicom digital signage products, all HighSecLabs products, all streaming, and all wireless products are covered by a standard three (3) year warranty.
4. All Sierra Video MultiViewers are covered by a standard five (5) year warranty.
5. Sierra switchers & control panels are covered by a standard seven (7) year warranty (excluding power supplies and fans that are covered for three (3) years).
6. K-Touch software is covered by a standard one (1) year warranty for software updates.
7. All Kramer passive cables are covered by a lifetime warranty.

Who is Covered

Only the original purchaser of this product is covered under this limited warranty. This limited warranty is not transferable to subsequent purchasers or owners of this product.

What Kramer Electronics Will Do

Kramer Electronics will, at its sole option, provide one of the following three remedies to whatever extent it shall deem necessary to satisfy a proper claim under this limited warranty:

1. Elect to repair or facilitate the repair of any defective parts within a reasonable period of time, free of any charge for the necessary parts and labor to complete the repair and restore this product to its proper operating condition. Kramer Electronics will also pay the shipping costs necessary to return this product once the repair is complete.
2. Replace this product with a direct replacement or with a similar product deemed by Kramer Electronics to perform substantially the same function as the original product. If a direct or similar replacement product is supplied, the original product's end warranty date remains unchanged and is transferred to the replacement product.
3. Issue a refund of the original purchase price less depreciation to be determined based on the age of the product at the time remedy is sought under this limited warranty.

What Kramer Electronics Will Not Do Under This Limited Warranty

If this product is returned to Kramer Electronics or the authorized dealer from which it was purchased or any other party authorized to repair Kramer Electronics products, this product must be insured during shipment, with the insurance and shipping charges prepaid by you. If this product is returned uninsured, you assume all risks of loss or damage during shipment. Kramer Electronics will not be responsible for any costs related to the removal or re-installation of this product from or into any installation. Kramer Electronics will not be responsible for any costs related to any setting up this product, any adjustment of user controls or any programming required for a specific installation of this product.

How to Obtain a Remedy Under This Limited Warranty

To obtain a remedy under this limited warranty, you must contact either the authorized Kramer Electronics reseller from whom you purchased this product or the Kramer Electronics office nearest you. For a list of authorized Kramer Electronics resellers and/or Kramer Electronics authorized service providers, visit our web site at www.kramerav.com or contact the Kramer Electronics office nearest you.

In order to pursue any remedy under this limited warranty, you must possess an original, dated receipt as proof of purchase from an authorized Kramer Electronics reseller. If this product is returned under this limited warranty, a return authorization number, obtained from Kramer Electronics, will be required (RMA number).

You may also be directed to an authorized reseller or a person authorized by Kramer Electronics to repair the product.

If it is decided that this product should be returned directly to Kramer Electronics, this product should be properly packed, preferably in the original carton, for shipping. Cartons not bearing a return authorization number will be refused.

Limitation of Liability

THE MAXIMUM LIABILITY OF KRAMER ELECTRONICS UNDER THIS LIMITED WARRANTY SHALL NOT EXCEED THE ACTUAL PURCHASE PRICE PAID FOR THE PRODUCT. TO THE MAXIMUM EXTENT PERMITTED BY LAW, KRAMER ELECTRONICS IS NOT RESPONSIBLE FOR DIRECT, SPECIAL, INCIDENTAL OR CONSEQUENTIAL DAMAGES RESULTING FROM ANY BREACH OF WARRANTY OR CONDITION, OR UNDER ANY OTHER LEGAL THEORY. Some countries, districts or states do not allow the exclusion or limitation of relief, special, incidental, consequential or indirect damages, or the limitation of liability to specified amounts, so the above limitations or exclusions may not apply to you.

Exclusive Remedy

TO THE MAXIMUM EXTENT PERMITTED BY LAW, THIS LIMITED WARRANTY AND THE REMEDIES SET FORTH ABOVE ARE EXCLUSIVE AND IN LIEU OF ALL OTHER WARRANTIES, REMEDIES AND CONDITIONS, WHETHER ORAL OR WRITTEN, EXPRESS OR IMPLIED. TO THE MAXIMUM EXTENT PERMITTED BY LAW, KRAMER ELECTRONICS SPECIFICALLY DISCLAIMS ANY AND ALL IMPLIED WARRANTIES, INCLUDING, WITHOUT LIMITATION, WARRANTIES OF MERCHANTABILITY AND FITNESS FOR A PARTICULAR PURPOSE. IF KRAMER ELECTRONICS CANNOT LAWFULLY DISCLAIM OR EXCLUDE IMPLIED WARRANTIES UNDER APPLICABLE LAW, THEN ALL IMPLIED WARRANTIES COVERING THIS PRODUCT, INCLUDING WARRANTIES OF MERCHANTABILITY AND FITNESS FOR A PARTICULAR PURPOSE, SHALL APPLY TO THIS PRODUCT AS PROVIDED UNDER APPLICABLE LAW. IF ANY PRODUCT TO WHICH THIS LIMITED WARRANTY APPLIES IS A "CONSUMER PRODUCT" UNDER THE MAGNUSON-MOSS WARRANTY ACT (15 U.S.C.A. §2301, ET SEQ.) OR OTHER APPLICABLE LAW, THE FOREGOING DISCLAIMER OF IMPLIED WARRANTIES SHALL NOT APPLY TO YOU, AND ALL IMPLIED WARRANTIES ON THIS PRODUCT, INCLUDING WARRANTIES OF MERCHANTABILITY AND FITNESS FOR THE PARTICULAR PURPOSE, SHALL APPLY AS PROVIDED UNDER APPLICABLE LAW.

Other Conditions

This limited warranty gives you specific legal rights, and you may have other rights which vary from country to country or state to state.

This limited warranty is void if (i) the label bearing the serial number of this product has been removed or defaced, (ii) the product is not distributed by Kramer Electronics or (iii) this product is not purchased from an authorized Kramer Electronics reseller. If you are unsure whether a reseller is an authorized Kramer Electronics reseller, visit our web site at www.kramerav.com or contact a Kramer Electronics office from the list at the end of this document.

Your rights under this limited warranty are not diminished if you do not complete and return the product registration form or complete and submit the online product registration form. Kramer Electronics thanks you for purchasing a Kramer Electronics product. We hope it will give you years of satisfaction.



SAFETY WARNING

Disconnect the unit from the power supply before opening and servicing

For the latest information on our products and a list of Kramer distributors, visit our website where updates to this user manual may be found.

We welcome your questions, comments, and feedback.

The terms HDMI, HDMI High-Definition Multimedia Interface, and the HDMI Logo are trademarks or registered trademarks of HDMI Licensing Administrator, Inc. All brand names, product names, and trademarks are the property of their respective owners.