

DESK MOUNT DUAL MONITORS DISPLAY ARM

FIXATION DE BUREAU
BRAS D’AFFICHAGE DOUBLE ÉCRANS

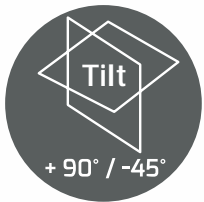

Tilt up / down
Inclinaison haut / bas

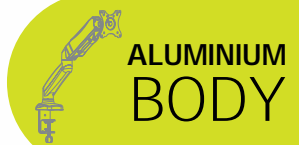
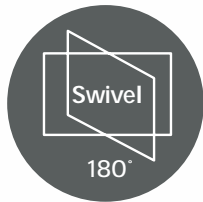

Swivel right / left
Pivot droite / gauche

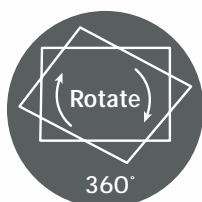

Rotation landscape / portrait
Rotation paysage / portrait

For **MONITORS
UP TO 32"**

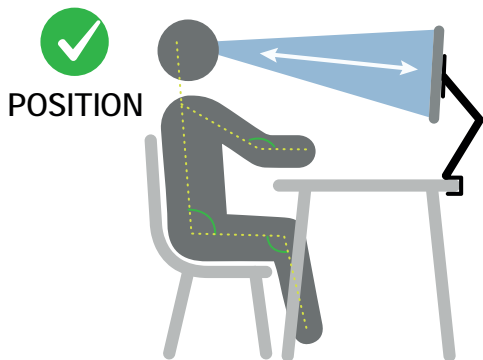

POSITION
Ergonomic design reduces musculo skeletal disorders
Conception ergonomique réduisant les troubles musculo-squelettiques

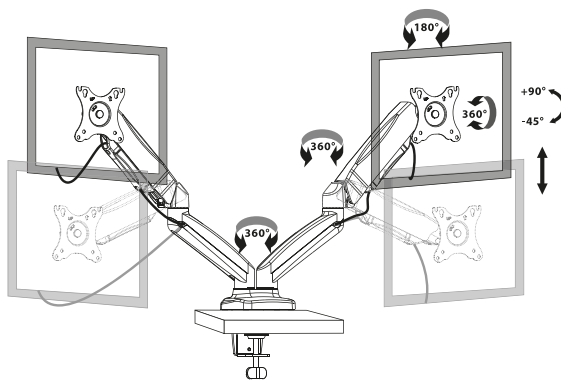

Fully adjustable arm for optimal positioning
Bras entièrement réglable pour un positionnement optimal

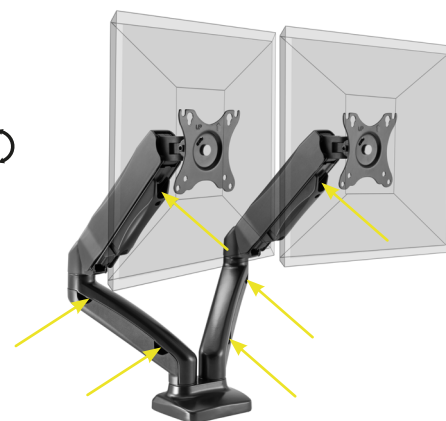

Cable path through to hide and maintain cables away
Passage de câbles pour cacher et maintenir les câbles à distance

DUAL MONITORS DISPLAY ARM

- Display arm for two monitors.
- Wide screen compatibility up to 32 inches.
- Fully articulated arm for optimal positioning.
- Dual screen orientation in landscape and portrait mode.
- Ergonomic design helps reduce musculoskeletal disorders.
- Cable management system to free up workstation space.
- Supports heavy screens up to 8kg (17.6 lbs).
- Quick installation of the screen thanks to its removable VESA fixation (100 x 100 mm and 75x75 mm).
- Two possible methods of installation on the desk: by clamp or by grommets base.

BRAS D'AFFICHAGE POUR ÉCRAN

- Bras d'affichage pour deux moniteurs.
- Large compatibilité d'écran jusqu'à 32 pouces.
- Bras entièrement articulé pour un positionnement optimal.
- Double orientation de l'écran en mode paysage et portrait.
- Conception ergonomique permettant de réduire les troubles musculo-squelettiques.
- Passage de câble libérant de la place sur le poste de travail.
- Supporte les écrans lourds jusqu'à 8kg (17,6 lbs).
- Installation rapide de l'écran grâce à sa fixation VESA amovible (100 x 100 mm et 75x75 mm).
- Deux méthodes possibles d'installation sur le bureau : par pince ou par base à ceilllets.

DE DOPPELMONITOR-ANZEIGEARM

- Anzeigearm für zwei Monitore
- Breitbildkompatibilität bis zu 32 Zoll
- Vollgelenkarm für optimale Positionierung

ES BRAZO PARA PANTALLA DE DOBLE MONITOR

- Brazo de pantalla para dos monitores
- Compatibilidad con pantallas anchas de hasta 32 pulgadas
- Brazo completamente articulado para conseguir un posicionamiento óptimo

NL DISPLAYBEUGEL VOOR DUBBELE MONITOR

- Displaybeugel voor twee monitoren
- Compatibiliteit met breedbeeldschermen tot 32 inch
- Volledig gearctueerde beugel voor optimale positionering

RU ДВОЙНОЙ ДЕРЖАТЕЛЬ ДЛЯ МОНИТОРА И ДИСПЛЕЯ

- Держатель для двух мониторов
- Возможность использования с экраном диагональю до 32 дюймов
- Полностью шарнирный держатель для оптимального позиционирования

PT BRAÇO DE MONITOR DUPLO

- Braço de monitor para dois monitores
- Compatibilidade com ecrãs wide screen até 32 polegadas
- Braço totalmente articulado para posicionamento ideal

SV DUBBEL MONITORSKÄRMSARM

- Displayarm för två bildskärmar
- Bred skärmkompatibilitet upp till 32 tum
- Fullt ledad arm för optimal positionering

IT BRACCIO PORTASCHERMO DOPPIO

CS DRŽÁK PRO DVA MONITORY

PL RAMI DO DWÓCH WY WIETLACZY

AR ضرع شاشة ثةجوزم عارذ

SK RAMENO DUÁLNEHO ZOBRAZOVACIEHO

TECHNICAL SPECIFICATIONS

PRODUCT NAME	MONITOR ARM VESA DUAL SCREEN
REF - EAN	901105 - 3567049011055
SPECIFICATIONS	<ul style="list-style-type: none"> • Universal vesa screen fixation (75x75/100x100) up to 32" • Supports heavy screens up to 8kg (17,6 lbs) • 2 desk fixation methods: clamp or grommet base
CONTENTS	1 dual monitor display arm 1 user manual
COMPATIBILITY	Monitors up to 32"
PRODUCT DIMENSIONS Width x Height x Depth	13,5 x 41 x 10,5 cm
PRODUCT WEIGHT	3,8 kg
PACKAGED DIMENSIONS Width x Height x Depth	41 x 17,5 x 30,7 cm
PACKAGED WEIGHT	4,3 kg
PCB	1
MATERIAL	Aluminium + plastic + steel
COUNTRY OF ORIGIN	China
WARRANTY	2 years warranty



2 fixation systems

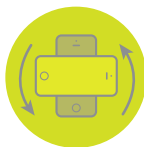

Pictures submit to change / Photos non-contractuelles - All trademarks and registered trademarks are the property of their respective owners / Toutes les marques commerciales et marques commerciales déposées sont les propriétés de leurs détenteurs respectifs