

# CAMBRIDGE NPX CONVENIENCE PAGING STATIONS NPX H1040/G1040/H1100/G1100

## Installation & Operation Guide



NPX H1040/G1040



NPX H1100/G1100

**NPX H1040/G1040 Paging Stations** are 4-button convenience paging stations with a handheld or gooseneck microphone for use in Tesira® and Qt X systems. Each features embedded DSP and on-board memory to support stored message playback and customized preambles.

**NPX H1100/G1100 Paging Stations** are 10-button convenience paging stations with a handheld or gooseneck microphone for use in Tesira and Qt X systems. The H1100/G1100 feature embedded DSP and on-board memory to support standard and advanced public address functionalities.

### Setup and Use

The Tesira software provides an intuitive interface for setup and programming of the NPX paging stations. The information supplied by this manual relates to physical connections and device setup. For more details on using the NPX with Tesira software, please consult the [Tesira Help File](#).

NPX paging stations may be integrated into a Qt X sound masking system as discoverable devices and are configurable with Qt X software. Click [here](#) for information on the Qt X software system management. NPX firmware can be updated through the Qt X software.

**Important Note:** The NPX devices can either be configured with Tesira or Qt X software systems. Once the NPX is discovered / configured with Tesira it can not be discovered with Qt X software until the configuration is cleared, and the reverse is also true. If discovered / configured in a Qt X system, then it will not be discoverable in Tesira until it is removed from the system and the configuration cleared.

The following NPX Paging Station Device Maintenance actions require Windows® 10 OS Version 1809 or newer:

- Firmware Updates
- Network Settings
- Upload and Download of Preambles and Recordings
- Device Security Settings
- Device Description
- Add/Modify/Remove Station PIN

To remove Page Codes and create or update Tesira layouts that include NPX, the user may use Windows 7 or versions of Windows 10 older than 1809.

### Installation

Each model supports both tabletop and wall mounting with a removable “foot” that allows the paging station to be mounted flat against any surface. Click [here](#) for installation details.



# PRODUCT REPRESENTATION



Figure 1: NPX G1100 Front Panel



Figure 2: NPX H1100 Front Panel

## Front

1. **LCD Menu Navigation Buttons**  
Up, Down and Select buttons allow the user to navigate the LCD menu.
2. **LCD**  
Allows the user to view menus and functions. See Operation for more details.
3. **Page Code Selection Buttons**  
Defines a voice-paging operation including its type, destination and priority.
4. **Microphone**
5. **Page Status LED Indicators**  
Indicates if the user is in Talk/Don't Talk modes:

Status	LED Indicator
Talk Now PTT	Right LED Green Solid
Talk Now Latching	Right LED Green Pulsing
No Talk	Left LED Red Solid
Wait	Left LED Yellow Solid

6. **Press-to-Talk (PTT)**  
Allows the user to initiate announcements while holding the PTT button is down. The page ends when the PTT button is released.
7. **Latching Button (gooseneck only)**  
Keeps a page active until the button is pressed again or the PTT button is pressed.

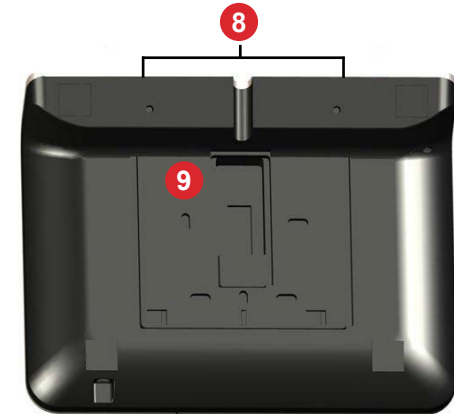

Figure 3: NPX Back Panel

## Back

8. **Removable Foot**  
The removable foot allows for flat surface and wall mounting.
9. **Back Plate**  
The removable back plate supports wall mounting.

**NOTE:** The regulatory label is located on the bottom of the unit.

## PRODUCT INSTALLATION

Install away from heat sources such as vents, radiators, heat registers and stoves or near water or steam. Do not exceed the maximum ambient operating temperature of 32-104° F (0-40° C).

NPX paging stations (handheld and gooseneck) may be installed in almost any location that is convenient for the room design requirements. This includes setting or attaching the device on a flat surface or to a wall. A Kensington lock can be used for added security while still allowing the NPX to be moved around.

### Table Installation

Follow steps 1-6 to attach the desk stand to a horizontal surface.

1. Determine where the NPX is to be located.
2. Remove the foot from the NPX by inserting a small Philips screwdriver or similar tool, with a maximum 3/16" (4.7mm) diameter, into the hole as shown in Figure 4.

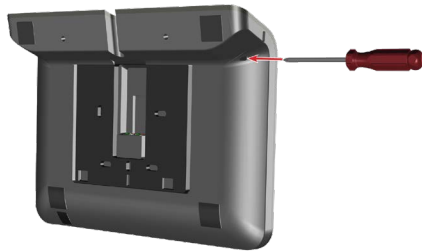

Figure 4: Foot Release

3. While pressing and holding the tool in the hole, slide the foot to the left and lift it away from the device as shown in Figure 5.

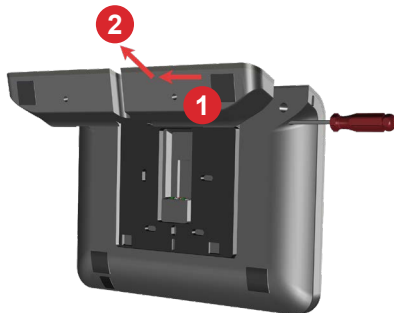

Figure 5: Foot Removal

4. Secure the foot to a flat surface. Cut a hole into the surface, below or just beyond, where the RJ-45 port at the back of the NPX will be located. Route RJ-45 up through the hole as shown in Figure 6.

**Note:** The cable can also be routed through the channel under the foot for unsecured stations.

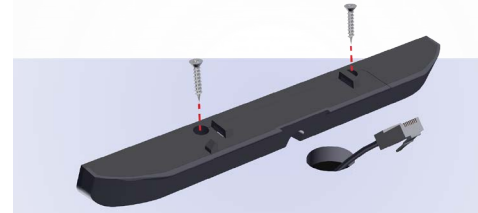

Figure 6: Foot Installation

5. Insert the RJ-45 into the port at the back of the NPX as shown in Figure 7.
6. Install the NPX onto the foot by pressing down and sliding the unit to the left as shown in Figure 8.

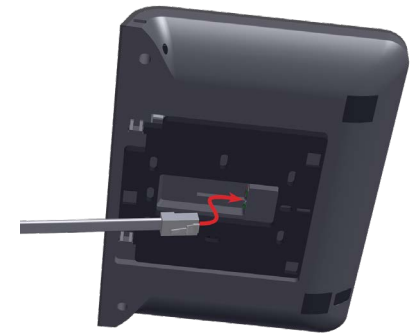

Figure 7: NPX Connection



Figure 8: NPX Installation

The security slot can accommodate a Kensington® lock (not included) Figure 9.



Figure 9: Security Slot

## PRODUCT INSTALLATION (continued)

### Wall-Mount Installation

The foot shipped attached to the unit must be removed and the back plate rotated 180° to mount the unit to a wall.

1. Determine the location where the NPX is to be mounted. The unit should be positioned to be accessible by the intended users.
2. Remove the foot from the NPX by inserting a small Philips screwdriver or similar tool (maximum 3/16" (4.7mm) diameter) into the hole as shown in Figure 10.
3. While pressing and holding the tool into the hole, slide the foot to the left and lift it away from the device as shown in Figure 11.

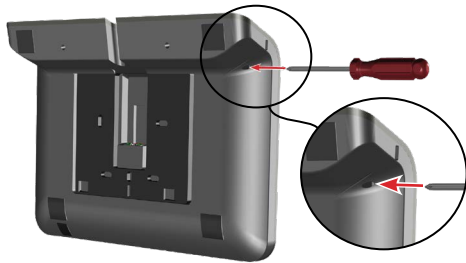

Figure 10: Foot Release

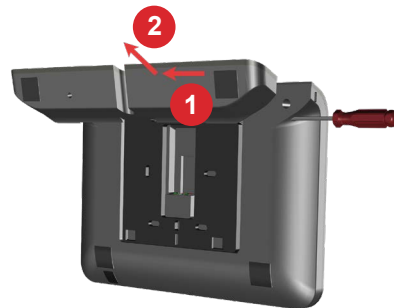

Figure 11: Foot Removal

4. Slide the back plate slightly to the left and lift it away from the device. Turn the bracket 180° as shown in Figure 12.

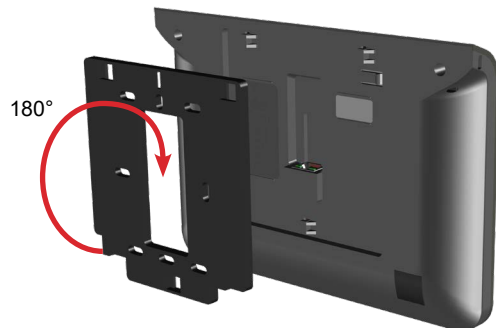

Figure 12: Back-Plate Removal

5. Attach the bracket to a single or double gang box with flat-head screws as shown in Figure 13. (Screws and gang box not included). The network cable should be routed into the gang box and terminated with an RJ-45 connector.

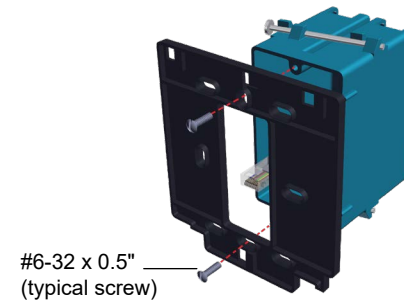

Figure 13: Back Plate Installation

6. Connect the RJ-45 to the port at the back of the NPX and attach the NPX to the back plate by inserting the tabs and sliding it to the left until it clicks into place as shown in Figure 14.

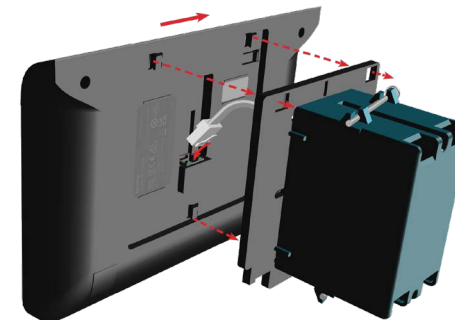

Figure 14: NPX Installation

7. Removing the NPX from the back plate is the opposite of step 6. Insert a tool into the release hole and slide the device to the right (instead of the left) and lift it off of the bracket.

# OPERATION

## LCD Button Navigation

Up, Down and Select navigation buttons adjacent to the LCD allow the user to navigate the system of menus for the NPX device.

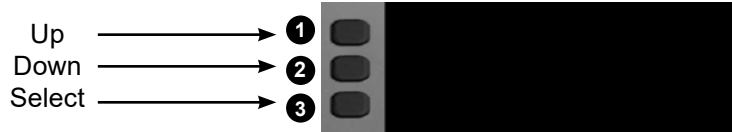

The table below shows the screens and navigation during and after powering up the NPX device:

Function	Navigation	LCD	Description
Splash Screen	• N/A		Displays when NPX device is powering on.
PIN Authentication	• N/A		Displays the PIN Authentication screen if a PIN code is required. There may be a brief delay before the next screen displays.
Device Status	<ul style="list-style-type: none"> <li>• Press and hold <b>3</b> and then press <b>2</b> to go to Device Information.</li> <li>• Press and hold <b>3</b> and then press <b>1</b> to go to Recordings.</li> </ul>		Ready for Configuration appears once the NPX device is discovered and has established communication with the system it is operating with (Tesira or Qt X).
Page Code Screen	<ul style="list-style-type: none"> <li>• Press <b>1</b> go to previous page code.</li> <li>• Press <b>2</b> to go to next page code.</li> <li>• Press and hold <b>3</b> and then press <b>2</b> to go to Device Information.</li> <li>• Press and hold <b>3</b> and then press <b>1</b> to go to Recordings.</li> <li>• Press <b>3</b> to return to Page Code.</li> </ul>		The Page Code screen displays after the launch of the NPX device. It allows the user to enter a page code from the keyboard, or scroll through the page codes list, to send a live page or play a recorded message. Click <a href="#">here</a> for paging details.
Device Information Screen	<ul style="list-style-type: none"> <li>• Press and hold <b>3</b> and then press <b>1</b> to go to Recordings.</li> <li>• Press <b>3</b> to return to Page Codes.</li> </ul>		Displays the Device Model, IP Address, Net Mask, Serial # and Firmware Version of the NPX.

## OPERATION (continued)

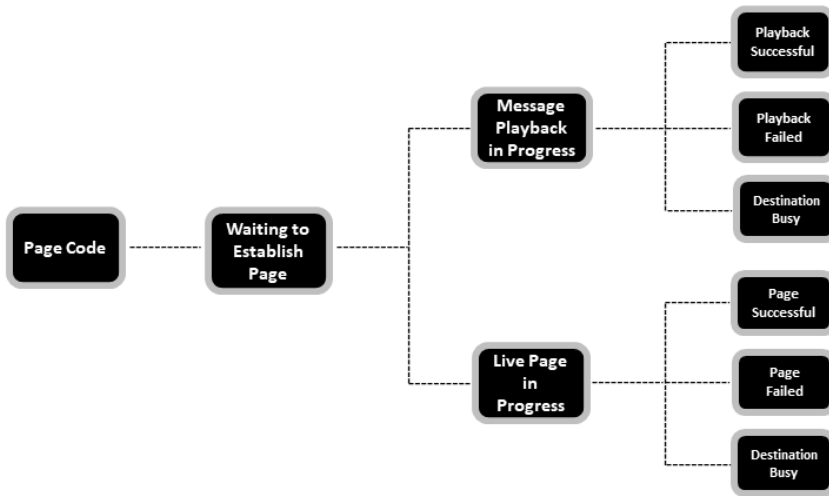

### Paging and Message Playback Instructions



#### Make a live page

1. At the Page Code screen press the top or middle LCD buttons next to to navigate to and highlight a specific page code. The user may also type the appropriate page code number on the keypad (10-key only).
2. Press and hold the PTT button, speak into the microphone and release the button when done. On gooseneck models the user may also tap the latching button, speak into the microphone and tap the button when done.

Target rings around the microphone icon allow the user to see when the optimal speaking level is reached:

Levels	Status
	The microphone icon displays when the user presses and holds the PTT button or taps the latching button. The green ring displays and flashes until the user speaks into the microphone.
	When the user speaks into the microphone, the outer green ring displays once the optimal speaking level is reached. The user may need to move closer to the microphone or speak louder.
	If the speaking level gets too loud the outer ring turns red. The user must move away from the microphone or speak more quietly to get to an acceptable level.

#### Playback a recorded message

3. At the Page Code screen press the top or middle LCD buttons next to to navigate to and highlight a specific page code. The user may also type the appropriate page code number on the keypad (10-key only).
4. Quickly press and release the PTT button to playback the recorded message.

#### Preambles

Live page and recorded message playbacks can be preceded by a preamble. The preamble plays first when the user presses and holds the PTT button or taps the latching button. The user can then make the live page or the recorded message plays back immediately after.

#### Page Failed

When a higher priority page code is already in progress. If any zones defined in the page zone are available (even if some zones are busy) the paging station will allow the page to the available zones.

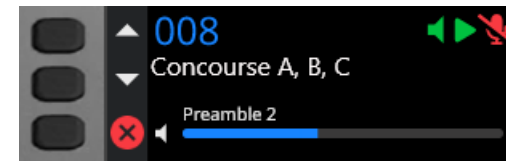

Figure 15: Preamble Playing



Figure 16: Live Page after Preamble

#### Playback Failed



The playback failed screen displays when the user tries to playback a message with a non-existent recording.

#### Navigation

See the [Navigation Table](#) for LCD navigation during paging activities and [LCD Icons](#) for descriptions.

## OPERATION (continued)

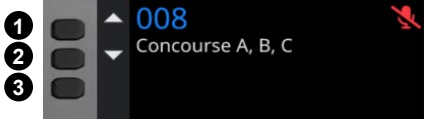
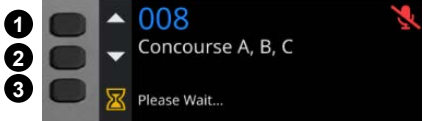
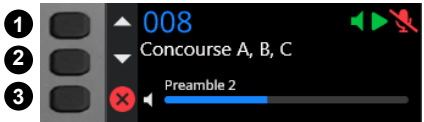
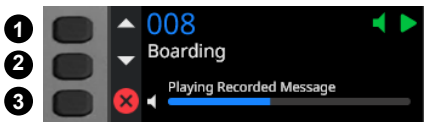
### Paging and Message Playback LCD Button Navigation

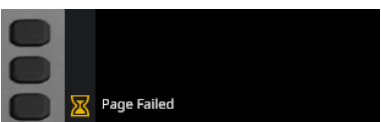
Function	Navigation	LCD	Description
Select a Page Code	<ul style="list-style-type: none"> <li>Press <b>1</b> or <b>2</b> to navigate to appropriate page code or type the page code number on the keypad (10-key only).</li> </ul>		Displays the current page code and allows the user to scroll to select a page code.
Establish Message Playback	<ul style="list-style-type: none"> <li>N/A</li> </ul>		Displays when the unit is establishing a message playback.
Preamble in Progress	<ul style="list-style-type: none"> <li>Press <b>3</b> to cancel preamble.</li> </ul>		Displays when preamble is in progress. Note that this cancels the preamble and the following action (either live page or prerecorded message playback).
Message Playback in Progress	<ul style="list-style-type: none"> <li>Press <b>3</b> to cancel playback.</li> </ul>		Displays when a message playback is in progress.
Live Page in Progress	<ul style="list-style-type: none"> <li>N/A</li> </ul>		Displays when a live page is in progress.
Page Failed	<ul style="list-style-type: none"> <li>N/A</li> </ul>		Displays briefly when a user attempts to make a page while a higher priority page code is already in progress.



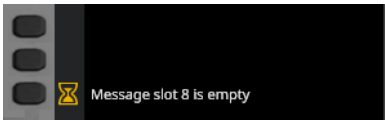
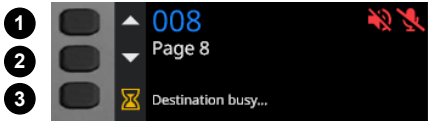

## OPERATION (continued)

### Paging and Message Playback LCD Button Navigation

Function	Navigation	LCD	Description
Playback Failed	<ul style="list-style-type: none"><li>N/A</li></ul>		Displays briefly when the user tries to play back a message with a non-existent recording.
Destination Busy	<ul style="list-style-type: none"><li>Press <b>1</b> to go to previous page code.</li><li>Press <b>2</b> to go to next page code.</li></ul>		Displays when at least two paging stations are connected to the same network and a message is already playing on one of them.  -OR-  A high priority page code interrupts the lower priority page code.

## Message Recording Instructions

### Record a message

- From the Page Code (default) screen, press and hold the bottom LCD screen button and then press the top button to go to the Recordings screen.
- Press the top or middle LCD buttons next to  to navigate to and highlight a specific recording slot.
- Press the bottom LCD button next to  to enter the selected Message Slot screen.
- Press the top LCD button next to the record button  to go to the Record Message screen.
- Press and hold the PTT button, speak into the microphone to record the message and release the button when done. On gooseneck models the user may also tap the latching button, speak into the microphone to record the message and tap the button when done.
- Press the top LCD screen button next to  to save the recording.
- Press the middle LCD screen button next to  to delete a recording. Press Yes or No to continue.

### Navigation

See the [navigation table](#) for LCD navigation during recording activities and [LCD icons](#) for descriptions.



**OPERATION** (continued)



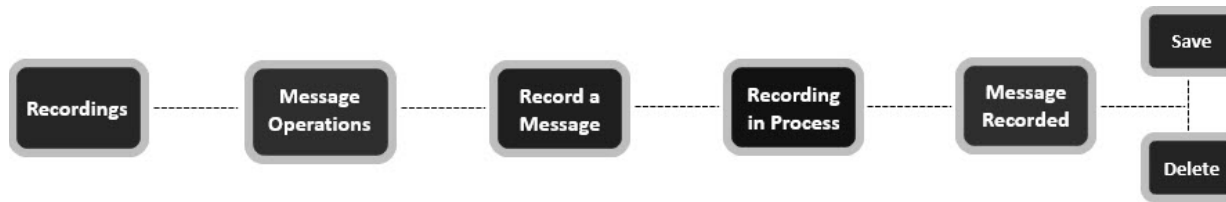











**Record a Message LCD Button Navigation**



Function	Navigation	LCD	Description
Recordings Screen	<ul style="list-style-type: none"> <li>Press <b>1</b> to go to previous recording slot.</li> <li>Press <b>2</b> to go to next recording slot.</li> <li>Press <b>3</b> to go to page code screen if slot is not selected.</li> </ul>		Displays the list of assigned and unassigned message slots.
Select Recording Slot	<ul style="list-style-type: none"> <li>Press <b>3</b> to go to message operations from the selected recording slot.</li> </ul>		
Message Operations Screen	<ul style="list-style-type: none"> <li>Press <b>1</b> to go to record Message.</li> <li>Press <b>2</b> to go to discard Message.</li> <li>Press <b>3</b> to return to Recordings.</li> </ul>		Displays the message slot with record or discard options.
Message Recording Screen	<ul style="list-style-type: none"> <li>Press <b>3</b> to go to message operations.</li> </ul>		Displays when the user is about to record a message.
Recording Message Screen	<ul style="list-style-type: none"> <li>N/A</li> </ul>		Displays when the message is being recorded from the microphone.
Message Recorded Screen	<ul style="list-style-type: none"> <li>Press <b>1</b> to save message and return to Recordings.</li> <li>Press <b>2</b> to discard message.</li> <li>Press <b>3</b> to return to recordings.</li> </ul>		Displays once the recording is complete.

**OPERATION** (continued)  
**LCD Icons and Fault Codes**

The icons below represent the LCD functions on the NPX device to help the user to navigate the function menus:

Icon	Function
	Paging microphone is active (unmuted) - Talk now
	Paging microphone is inactive (muted)
	Recorded announcement is being played to the destination zones
	Destination zones are busy. Page will fail.
	Please wait
	Return to the home screen
	Return to message slot screen
	Display the record message screen
	Selection arrows for page codes and recordings screens (previous/next)
	Device certificate is set to expire in 30 days
	Cancel preamble or recorded message playback already in progress
	Station is locked
	Delete the selected message
	Save a recent recording

System Alerts displays a list of current faults on the NPX device:

Fault Code	Description
DEVICE_TEMPERATURE	Device exceeded maximum temperature
HOST_COMMUNICATION_FAULT	Host communication fault
MESSAGE_MEMORY_FULL	Message memory full
FIRMWARE_UPDATE_FAILURE	Firmware update failure
AVB_STREAM_ERROR	AVB stream error
DANTE_STREAM_ERROR	Dante stream error
DANTE_LICENSE_ERROR	No Dante license found

## OPERATION (continued)

### Keypads

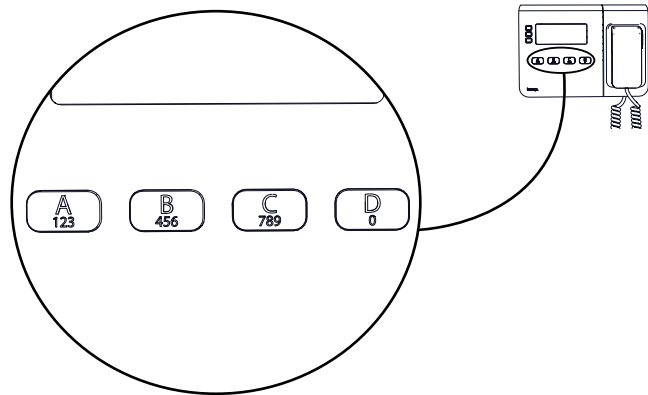

**NPX H1040/G1040 4-Key Keypad**

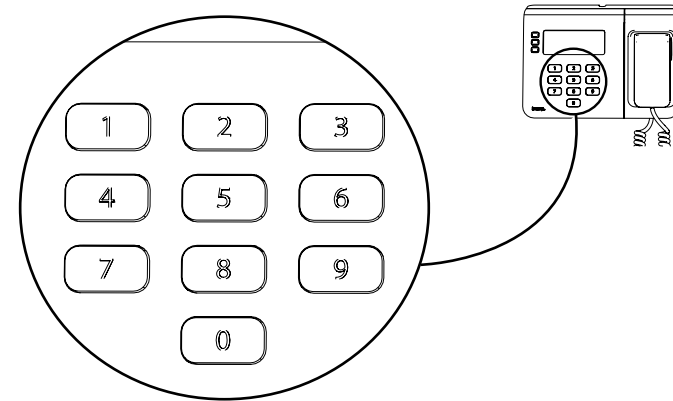

**NPX H1100/G1100 10-Key Keypad**

---

### Keypad Functionality

#### 4-Button

The 4-button station allows up to four page codes to be assigned (one for each of the four buttons A,B,C,D).

To unlock a station that has a PIN authorization, the user must repeatedly press the same key to cycle through the numbers for that key and then stop for 1.5 seconds until the displayed number is locked in.

- Button 'A' : is used to enter the number 1, 2 or 3
- Button 'B' : is used to enter the number 4, 5 or 6
- Button 'C' : is used to enter the number 7, 8 or 9w
- Button 'D' : is used to enter the number 0

To enter the PIN 4289 the user types the following sequence:  
B, <wait>, A, A, <wait>, C, C, <wait>, C, C, C, <wait>

#### 10-Button

The 10-button station allows up to 999 page codes to be assigned. Users can search for a page code by typing in the page code number on the keypad, or by navigating to the next/previous page code with the top two navigation buttons. A 4-digit PIN is required if the station is locked.

Page codes must be entered as 3 digits. For example, to show page code nine, the user would enter 0-0-9. For page code 20 the user would enter 0-2-0.

NPX provides 10 numbers for the 10-key and 14 letters/numbers for the 4-key functions as shown in the table below:



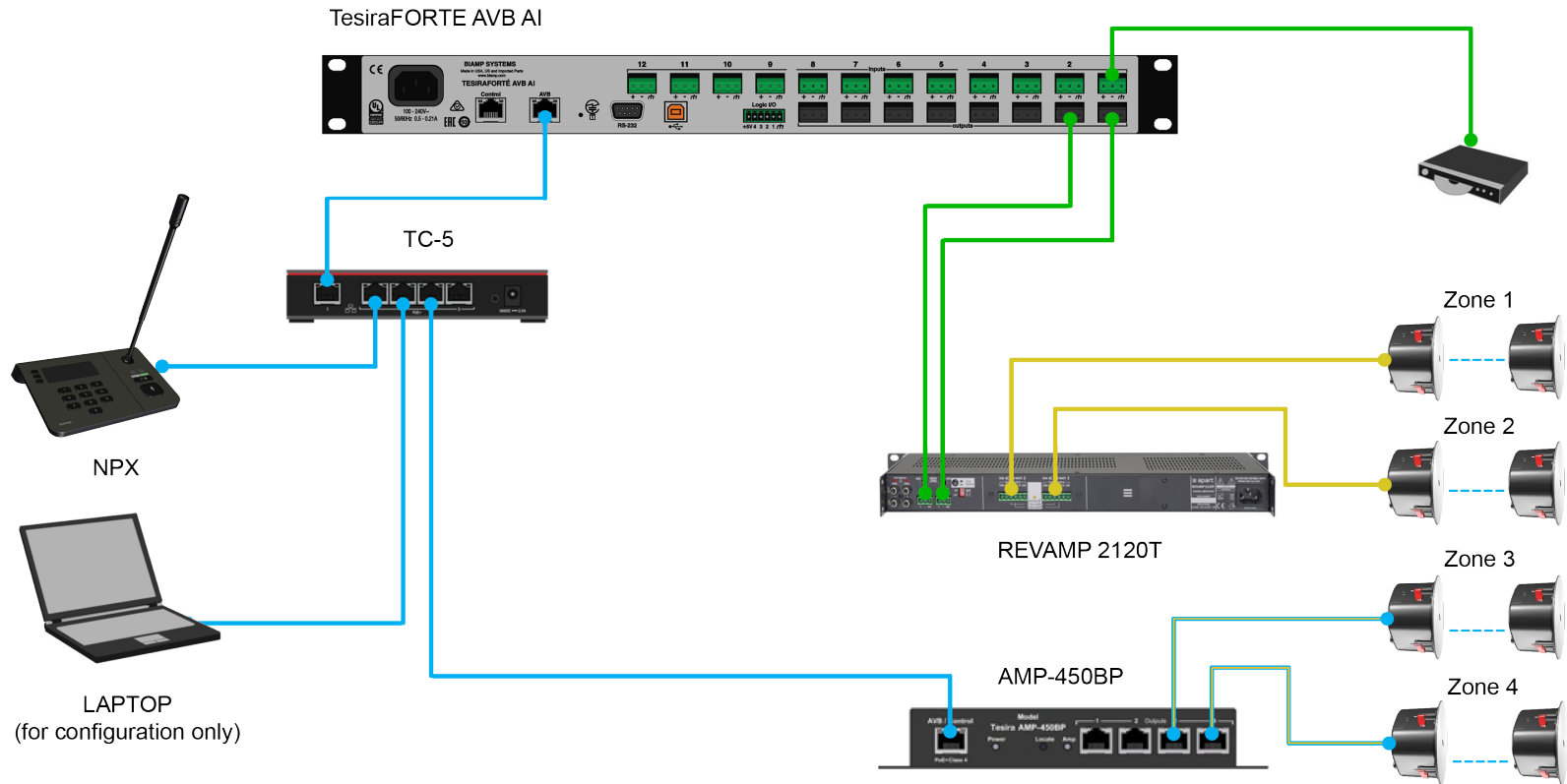

Type	Buttons	Function
10-Key Keypad	1, 2, 3, 4, 5, 6, 7, 8, 9, 0	Page Code Assignments
4-Key Keypad	A, B, C, D [1 2 3], [4 5 6], [7 8 9], [0]	Page Code Assignments (Letters) PIN Code (numbers)

# TYPICAL SYSTEM EXAMPLES

## NPX AVB Single Cable\*



**Cable Type**



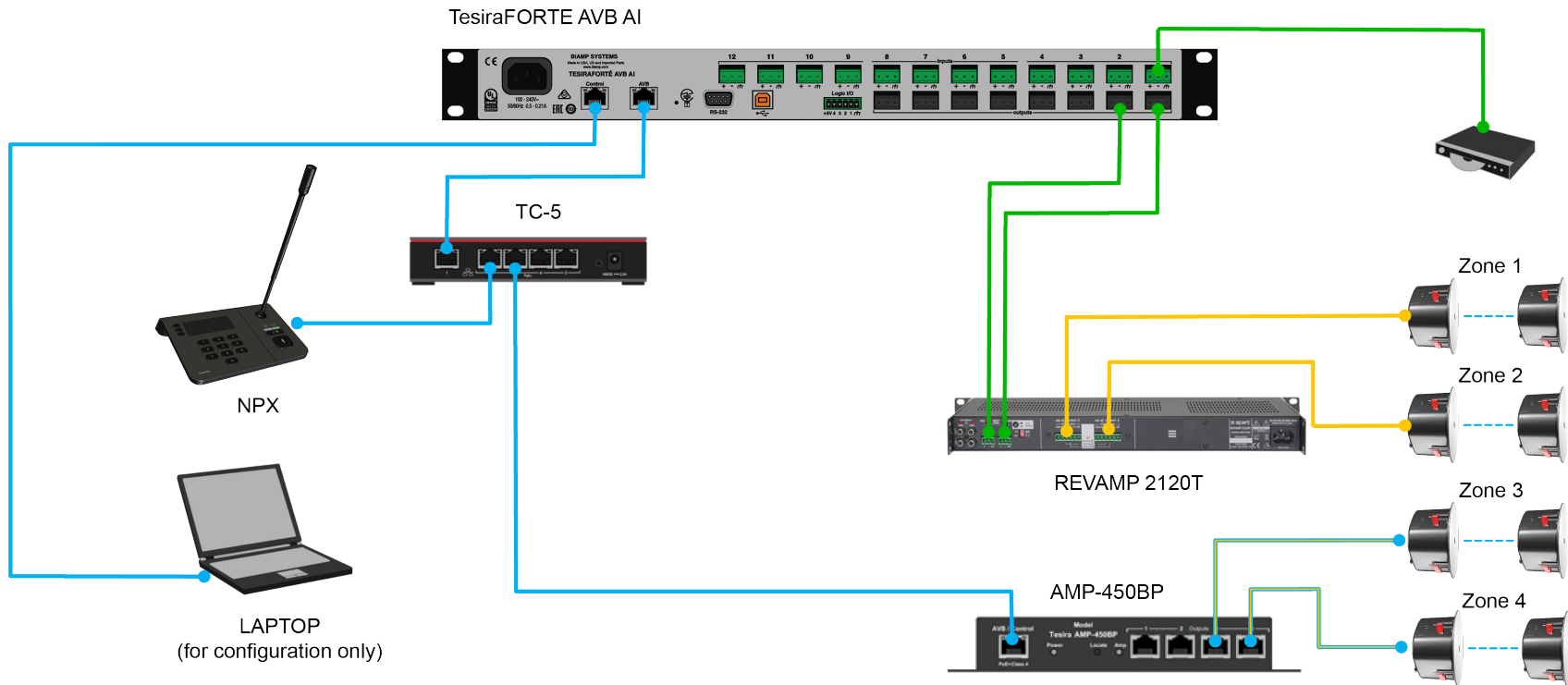

Network Cable	
Line Level Audio	
Speaker Level Audio	
Speaker Level Audio using Network Cable	

\*This example is the preferred solution for the NPX Paging Stations. In cases where AVB traffic and control are not allowed on the same network, see the NPX AVB Separate Networks example.

### NPX AVB Separate Networks





**Cable Type**

Network Cable	
Line Level Audio	
Speaker Level Audio	
Speaker Level Audio using Network Cable	

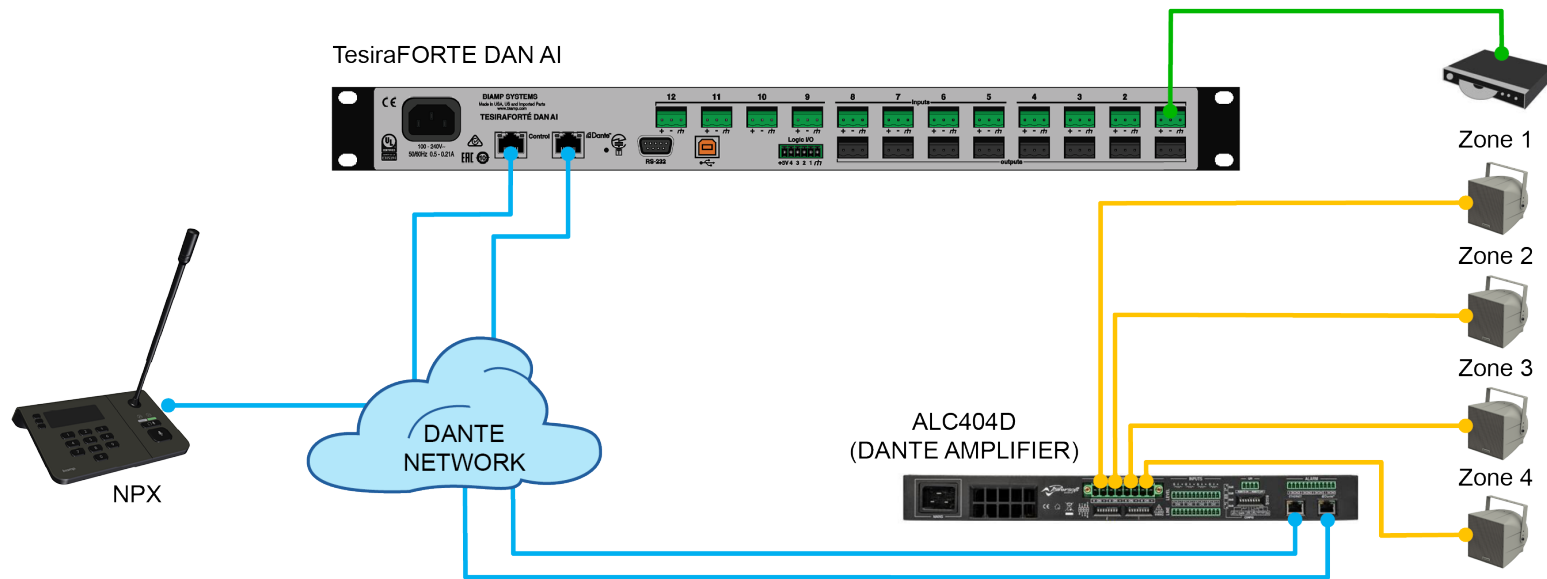
NPX with Dante®



Cable Type

Network Cable	
Line Level Audio	
Speaker Level Audio	

### NPX - Qt X Single Cable (Simple System)

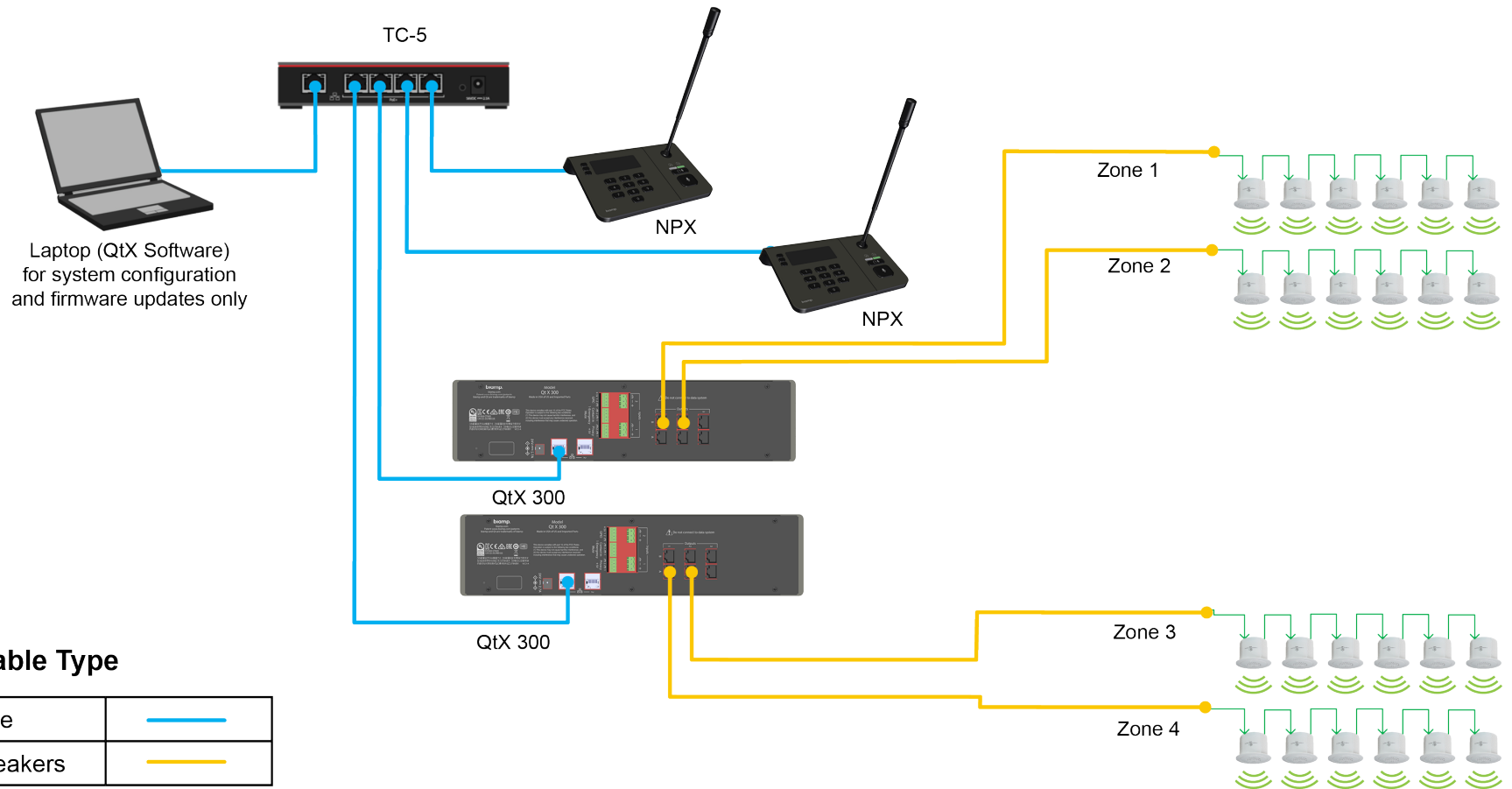

## TYPICAL SYSTEM EXAMPLES (continued)

### NPX - Qt X Single Cable (Expanded System)

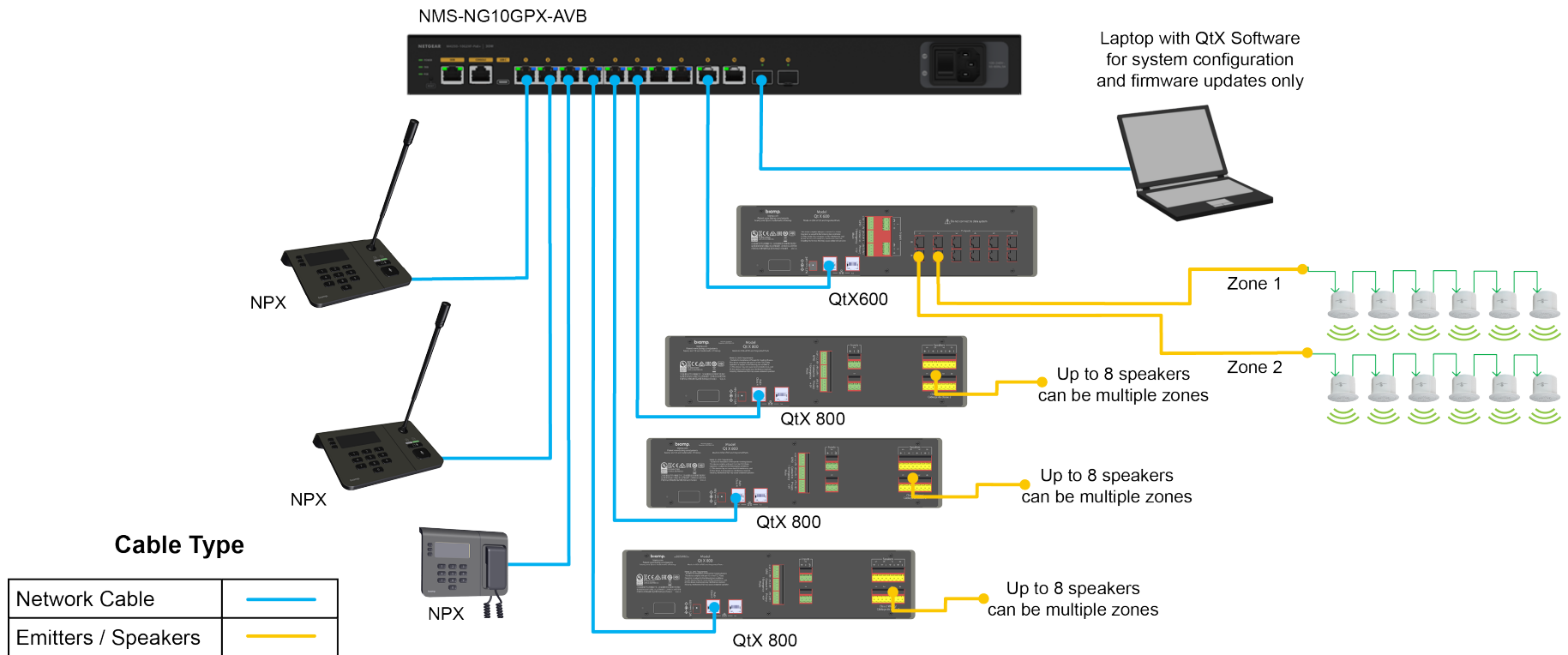

This configuration shows a single switch - Multiple switches may be used or daisy-chained together supporting PoE+ (Type 2) on 8 devices per switch.

## CONTACT US

**Email**  
support@biamp.com

**Web**  
support.biamp.com

**Warranty**  
www.biamp.com/legal/warranty-information

**Safety and Compliance**  
www.biamp.com/compliance

*Windows® is a registered trademark of the Microsoft group of companies.*

*Dante® is a registered trademark of Audinate*



A: 9300 S.W. Gemini Drive Beaverton, OR 97008 USA

W: www.biamp.com

10AUG2023