



by Schneider Electric

Installation Guide Smart-UPS™ X Tower/Rack-Mount 2U 2000/2200/3000 VA

Important Safety Messages

Read the instructions carefully to become familiar with the equipment before trying to install, operate, service or maintain it. The following special messages may appear throughout this manual or on the equipment to warn of potential hazards or to call attention to information that clarifies or simplifies a procedure.



The addition of this symbol to a Caution product safety label indicates that an electrical hazard exists which will result in personal injury if the instructions are not followed.

The following safety messages may appear throughout this manual to warn of potential hazards.

CAUTION

CAUTION indicates a potentially hazardous situation which, if not avoided, **can result in** equipment damage and minor or moderate injury.

CAUTION

CAUTION indicates a potentially hazardous situation which, if not avoided, **can result in** equipment damage.

Safety and General Information

Inspect the package contents upon receipt. Notify the carrier and dealer if there is any damage.

Read the Safety Guide supplied with this unit before installing the UPS.

- Adhere to all local and national electrical codes.
- This UPS is intended for indoor use only.
- Do not operate this UPS in direct sunlight, in contact with fluids, or where there is excessive dust or humidity.
- Be sure the air vents on the UPS are not blocked. Allow adequate space for proper ventilation.
- The battery typically lasts for two to five years. Environmental factors impact battery life. Elevated ambient temperatures, poor quality utility power, and frequent short duration discharges will shorten battery life.
- Connect the UPS power cable directly to a wall outlet. Do not use surge protectors or extension cords.
- The batteries are heavy. Remove the batteries prior to installing the UPS in a rack.
- Always install external battery packs (XLBPs) at the bottom of the rack. The UPS must be installed above the XLBPs.
- The UPS display interface will recognize as many as 10 external battery packs connected to the UPS. However there is no limit to the number of XLBPs that can be used with the UPS.

Inventory

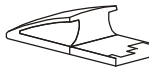
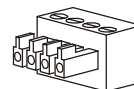
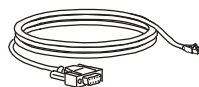
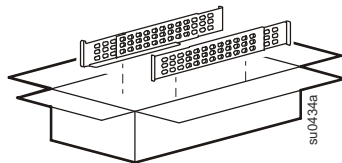
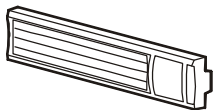

(4)

(4)

(6)

(2)

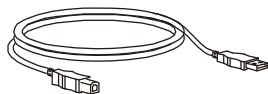

Not included with
SMX3000RMJ2U model

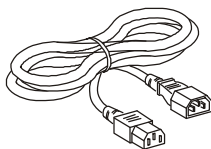

(2)
230 V models only



(2)
1 Documentation CD
1 PowerChute software CD not included with
SMX3000RMJ2U model

Models with preinstalled network cards

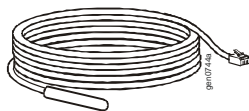

High voltage models only

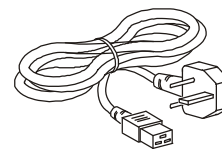
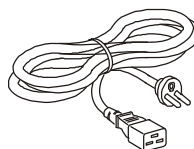
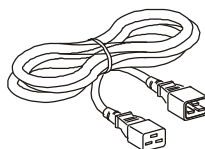

Installation

Remove the battery

⚠ CAUTION

DAMAGE TO EQUIPMENT OR PERSONNEL

- The equipment is heavy. Always practice safe lifting techniques adequate for the weight of the equipment.
- Remove the battery before installing the UPS in a rack.

Failure to follow these instructions can result in equipment damage and minor or moderate injury

Use the battery handle to pull the battery out of the unit.

1

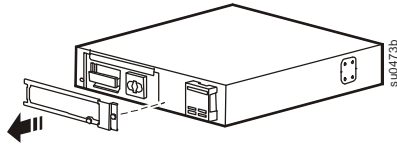

2

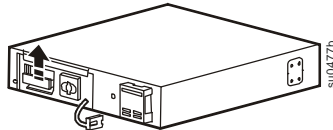

3

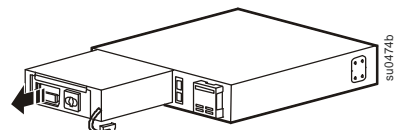

Four post rack installation

Use the APC Four Post Rail Kit (supplied).

1

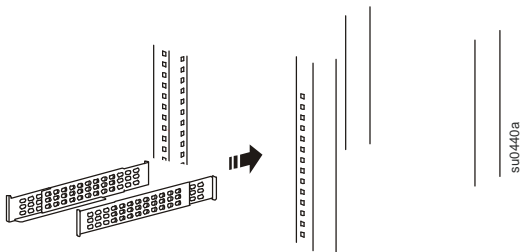

2

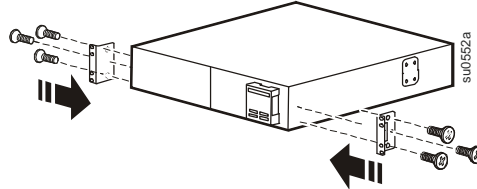

3

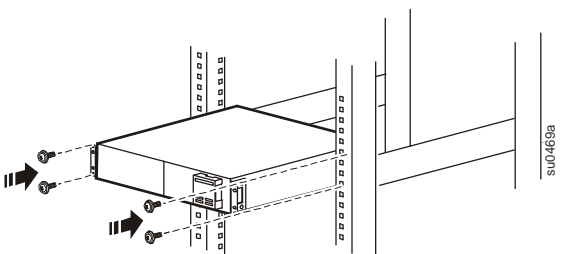

4

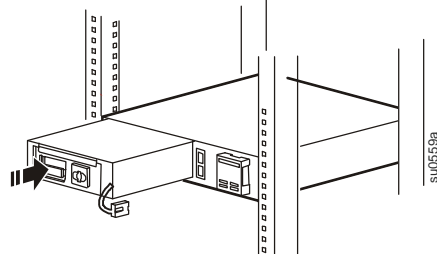

5

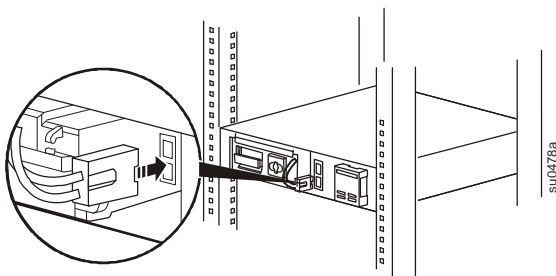

6

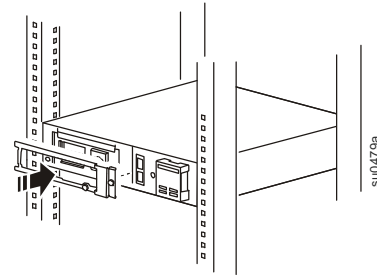

7

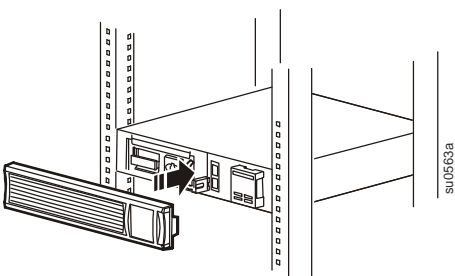

Two post rack installation

1

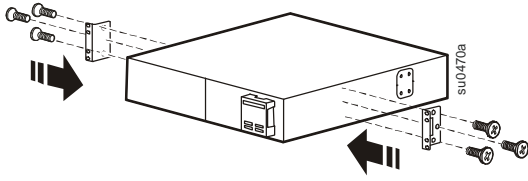

2

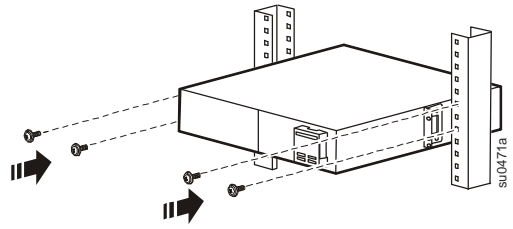

3

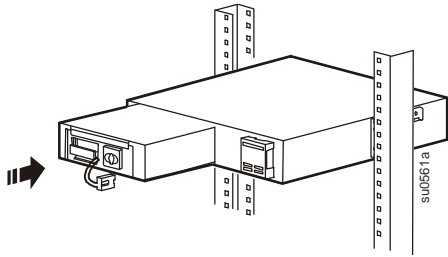

4

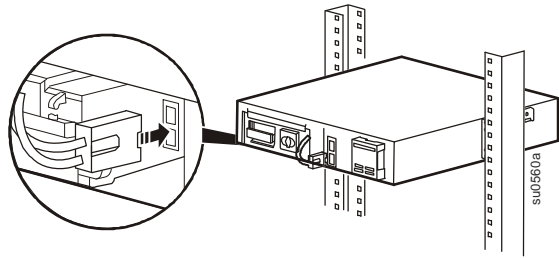

5

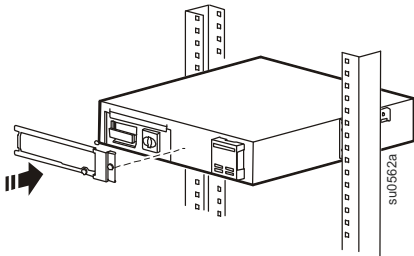

6

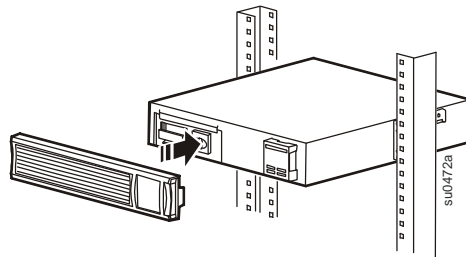

Rack to tower conversion

1

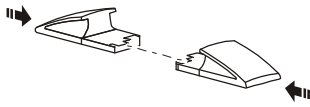

2

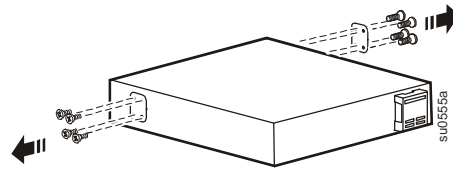

3

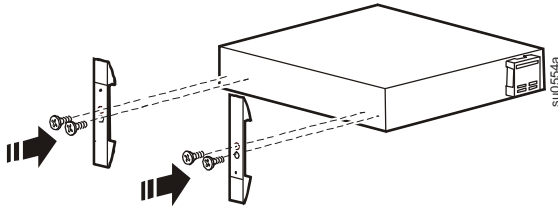

4

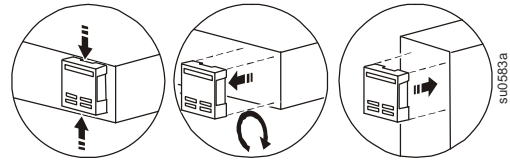

5

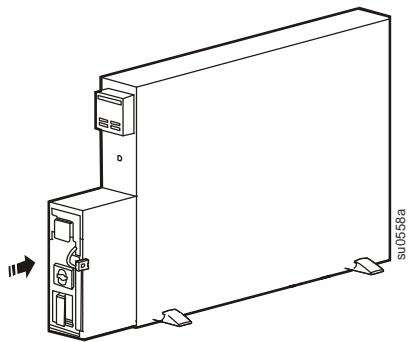

6

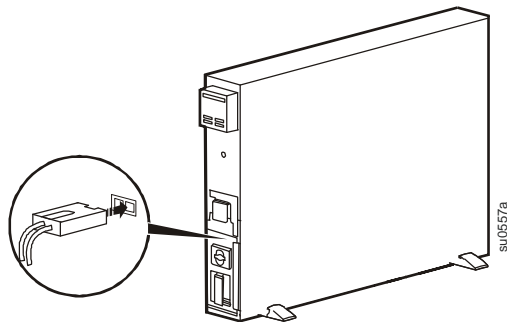

7

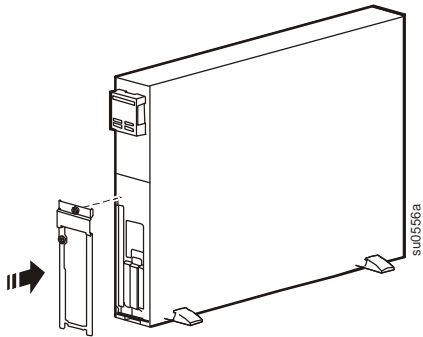

8

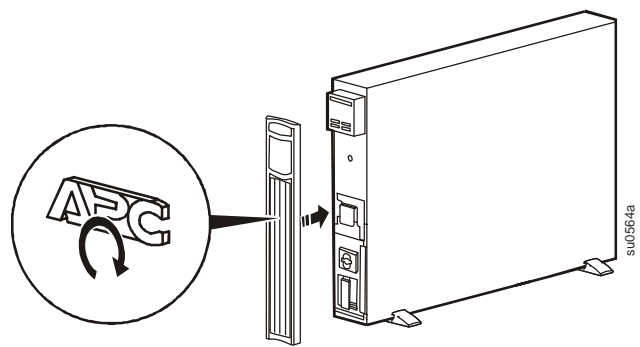

Start-Up and Configuration

Overview

2000 VA Low Voltage

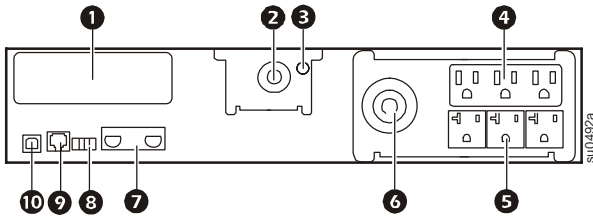

- ❶ SmartSlot
- ❷ UPS input
- ❸ Chassis ground screw
- ❹ Controllable Outlet Group 1
- ❺ Controllable Outlet Group 2
- ❻ Controllable Outlet Group 3
- ❼ External battery pack connector
- ❽ EPO connector
- ❾ Serial port
- ❿ USB port

2200/3000 VA High Voltage

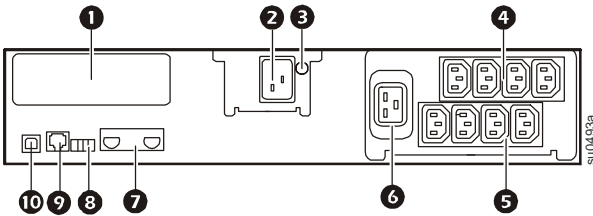

2200 VA Low Voltage

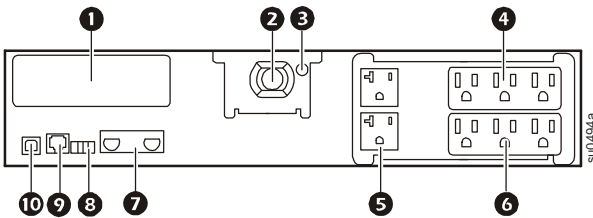

3000 VA Low Voltage

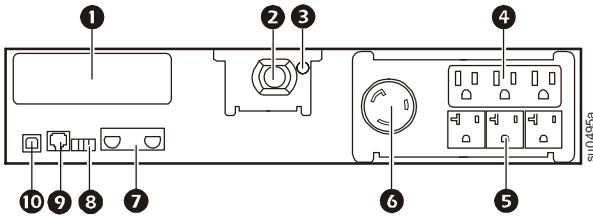

Controllable outlet groups

The outlets on the UPS are configured into groups. To configure the controlled outlet features, use the Advanced menus on the display interface and navigate to: **Main Menu > Control > Outlet1 Control**.

Emergency Power Off Connection

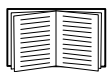

Refer to the user manual included on the CD that is supplied with the unit for more information on how to connect the Emergency Power Off (EPO) Switch.

Electrical connections

CAUTION

RISK OF EQUIPMENT DAMAGE

- Adhere to all local and national electrical codes.
- Wiring should be performed by qualified electrician.
- Always connect the UPS to a grounded outlet.

Failure to follow these instructions can result in equipment damage

1. Connect equipment to the outlets on the rear panel of the UPS.
2. Connect the UPS to the building utility power.
3. To use the UPS as a master ON/OFF switch, turn on all the equipment that is connected to the UPS.
4. Press the ON/OFF button on the front panel of the UPS to turn on the UPS and all connected equipment.
5. Refer to the Switched Outlet Groups section in the Operation manual for information on how to use the switched outlet groups.

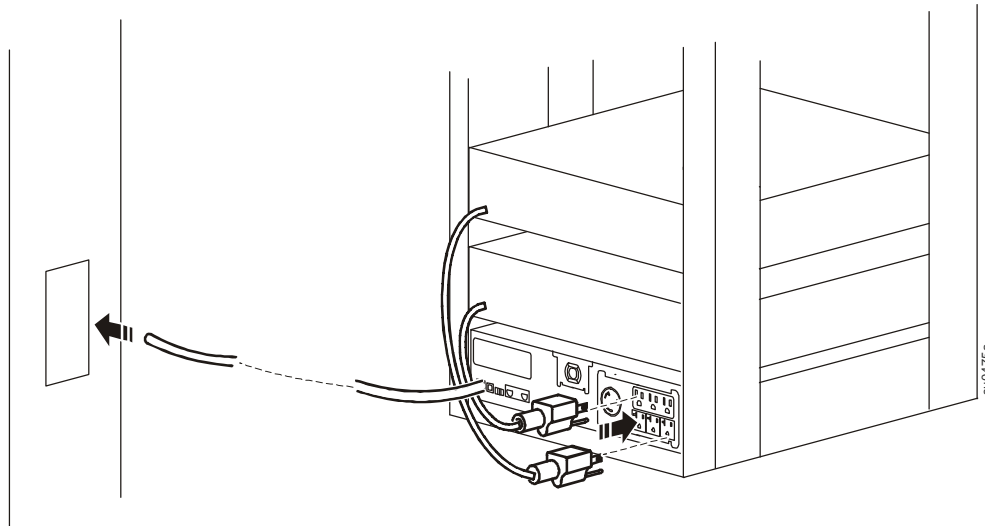

Display Interface

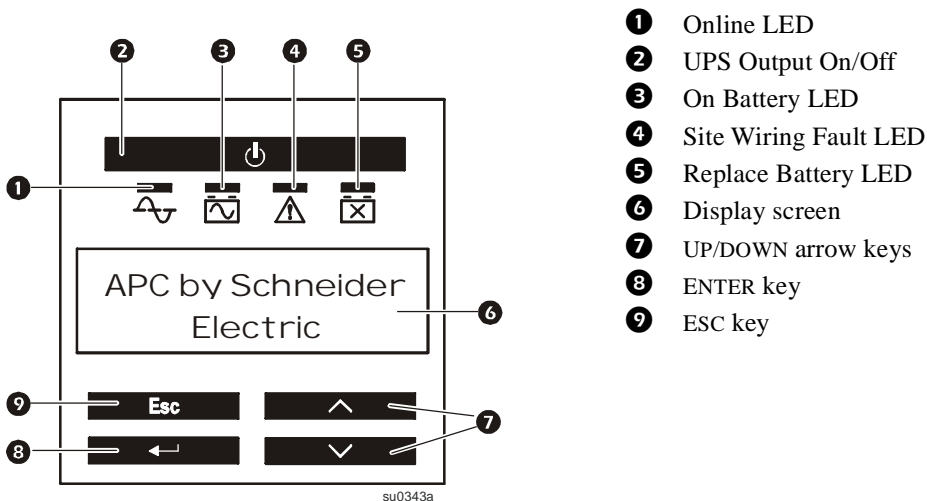



Select models are ENERGY STAR[®] qualified.

For more information go to www.apc.com/site/recycle/index.cfm/energy-efficiency/energy-star/