





AC1300 Nano Wireless MU-MIMO USB Adapter

Plug it. Forget it!



Archer T3U Nano

 867 Mbps on 5 GHz
400 Mbps on 2.4 GHz[†]

 Turbo QAM
256QAM
33% faster on 2.4GHz[†]

 MU-MIMO
Simultaneous data streams[†]

 WPA3
Advanced security[†]

Highlights

AC1300 Dual Band Wi-Fi

Receive Wi-Fi signals on two separate bands for all your online needs. Choose the 2.4 GHz band for browsing, email and social media, or switch to 5 GHz band for gaming and streaming.[†]

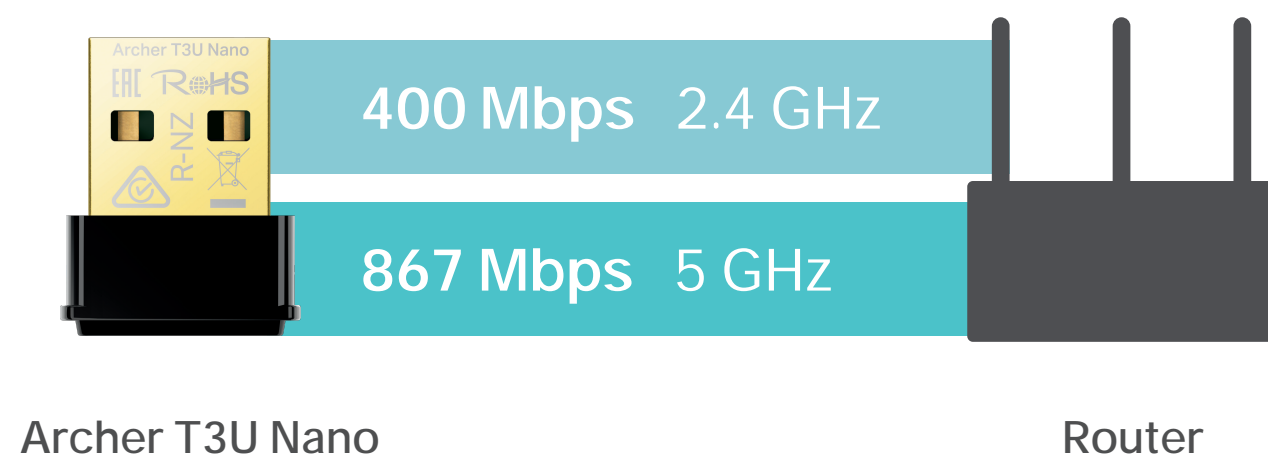

Tiny in Size, Mighty in Performance

Much smaller than regular USB flash drive, enjoy a stable and super-fast Wi-Fi wherever you need it.

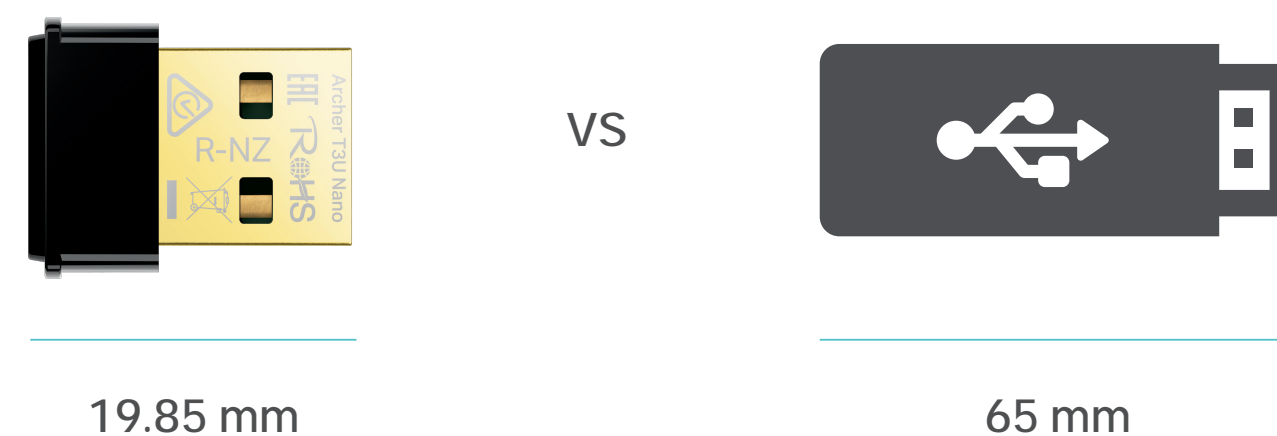

Highlights

Improved Security with WPA3

The latest Wi-Fi security protocol provides enhanced protection in personal password safety.†



Boosted Throughput with MU-MIMO

Works with MU-MIMO routers, which provide simultaneous data streams, boosting throughput and efficiency.‡

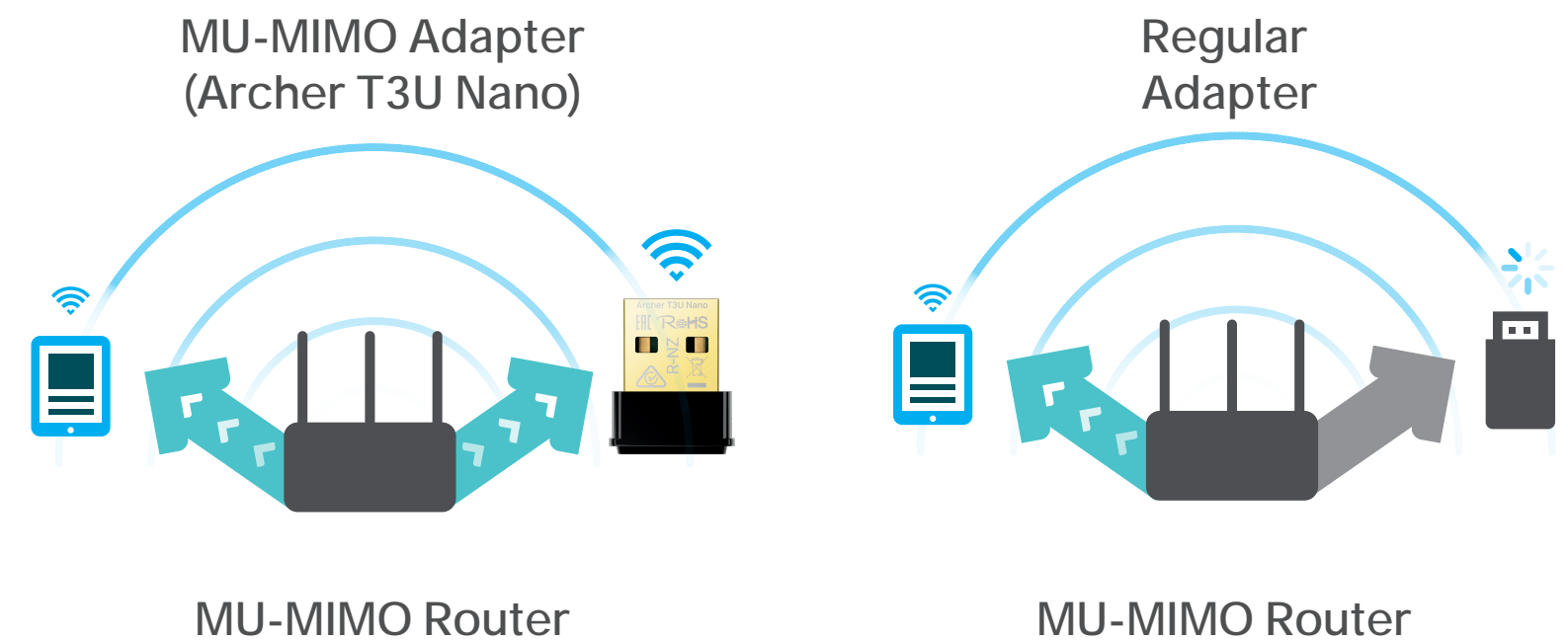

Features

Speed

- **Fast Wi-Fi** – 400 Mbps on 2.4 GHz and 867 Mbps on 5GHz wireless speeds are ideal for HD streaming video, lag-free gaming and large file downloads
- **802.11ac Support** – Wi-Fi technology that is 3 times faster than 802.11n

Design

- **Mini design** – The Archer T3U Nano is very small and can be left in a computer's USB port once plugged in

Reliability

- **Dual Band** – Selectable 2.4 GHz and 5 GHz bands to avoid wireless signal interference
- **Backwards Compatibility** – Supports routers utilizing 802.11 a/b/g/n Wi-Fi standards

Security

- **Active Defense** – WPA/WPA2/WPA3 encryption provides your Wi-Fi network with advanced protection against security threats

Ease of Use

- **Easy Installation** – A friendly user interface utility on a CD for simple installation

Specifications

Wireless

- Wireless Standard: IEEE 802.11b/g/n 2.4 GHz, IEEE 802.11a/n/ac 5 GHz
- Frequency: 2.4 GHz, 5 GHz
- Wireless Mode: Ad-Hoc / Infrastructure Mode
- Wireless Security: WEP, WPA/WPA2/WPA3, WPA-PSK/ WPA2-PSK, WPA3-SAE
- Modulation Technology: DBPSK, DQPSK, CCK, OFDM, 16-QAM, 64-QAM, 256-QAM

Hardware

- Interface: USB 2.0
- LED: Status
- Dimensions: 0.78 × 0.62 × 0.29 in (19.85 × 15.7 × 7.39 mm)

Others

- Package Contents
 - AC1300 Nano Wireless MU-MIMO USB Adapter Archer T3U Nano
 - Quick Installation Guide
 - Resource CD
- Certification
 - FCC, CE, RoHS
- System Requirements
 - Supported operating systems include Windows 10/8.1/8/7, macOS[§]
- Environment
 - Operating Temperature: 0°C~40°C (32°F ~104°F)
 - Operating Humidity: 10%~90% non-condensing
 - Storage Humidity: 5%~90% non-condensing



Mac Support



For more information, please visit

https://www.tp-link.com/products/details/?model=Archer+T3U+Nano_V1

or scan the QR code left

¹Maximum wireless signal rates are the physical rates derived from IEEE Standard 802.11 specifications. Actual wireless data throughput and wireless coverage, and quantity of connected devices are not guaranteed and will vary as a result of network conditions, AP limitations, and environmental factors, including building materials, obstacles, volume and density of traffic, and AP location.

⁴Use of MU-MIMO, 256-QAM and WPA3 requires clients to also support the corresponding features.

[§]To ensure compatibility, you may need to update the adapter's drivers after an OS update. You can check the full list of supported operating systems in the download center at tp-link.com/download-center.

©2020 TP-Link