



B-TECH AV MOUNTS

**WITH SOFT
 OPENING**

BT8312

SLIMLINE SOFT-OPEN FULL SERVICE VIDEOWALL MOUNT

Designed to make video wall installations as quick and simple as possible, this modular video wall mount can be used to create unlimited video wall configurations in both landscape and portrait format. The BT8312 low profile design is ideal for mounting into walls with a shallow recess or when space in front of the wall is minimal. 8 points of micro-adjustment makes accurate screen alignment quick and easy and the soft opening features a patent pending controlled release enabling access to the rear of the mounted screen for servicing and maintenance.

SPECIFICATION

Recommended screen size	42" - 75" (46" - 75" in portrait)
Max load	50kg
VESA® compatibility as standard	200 x 100 up to 400 x 400
VESA® compatibility with included adaptors	up to 600 x 400*
Flat to wall depth	69.5mm*(+/-7.5mm with micro-adjustment)
Popped out depth	222.5mm*(+/-7.5mm with micro-adjustment)
Tool-less micro-adjustment	+/-7.5mm per corner
Screen height adjustment	+15mm

*Please note using the included Interface Adaptor Arms to mount VESA 600 x 400 screens will increase the total depth of the product by 6mm, for a total depth of: 75.5mm or 228.5mm whilst popped out.



FEATURES

- Slim design ideal for low profile installs on walls or mounting in recesses
- Modular mount allows video wall assembly in an unlimited number of configurations
- Suitable for landscape or portrait screen mounting
- Patent pending pop-out system with soft opening provides a safe and easy service access
- Tool-less micro-adjustment of +/-7.5mm at each corner for seamless display alignment
- Keyhole mounting for quick and easy installation
- Suitable for both wall or pole mounting
- Screen specific wall plate spacers kits are available (separately) to speed up installation times
- Integrated locking mechanism prevents accidental pop-out of mount
- Safety screws help prevent unauthorised removal of screens
- Adaptor arms for VESA 800 x 400 xings (BT7565) available separately

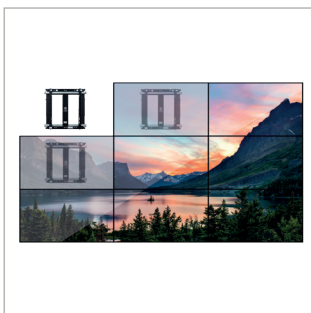

Modular mount allows video wall assembly in an unlimited number of configurations

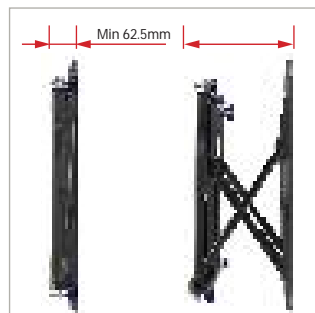

Slimline design with soft opening provides quick and easy service access



8 points of micro-adjustment for depth, height and lateral screen adjustment

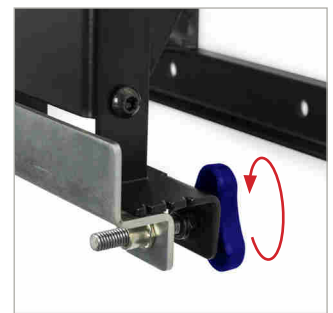

Tool-less micro-adjustment of +/-7.5mm at each corner for seamless display alignment



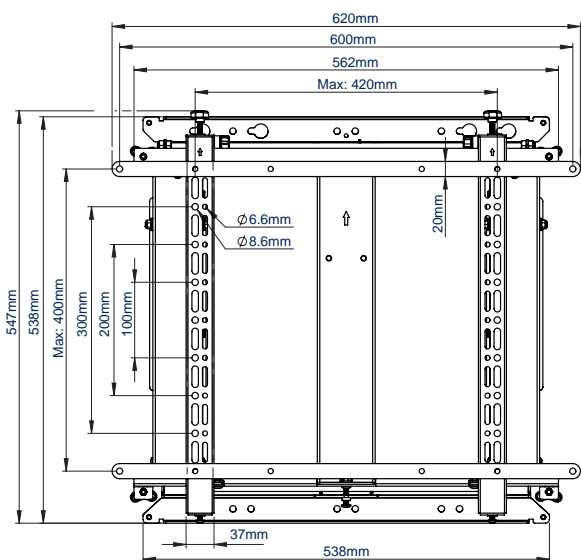

FRONT VIEW WITH ADAPTOR ARMS

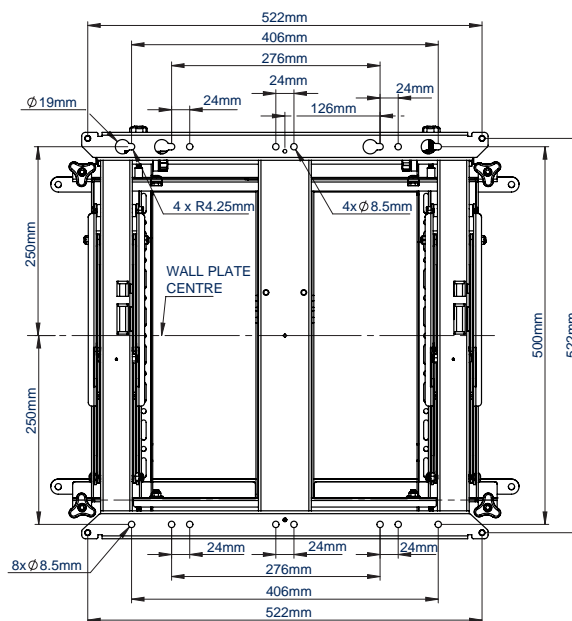

REAR VIEW

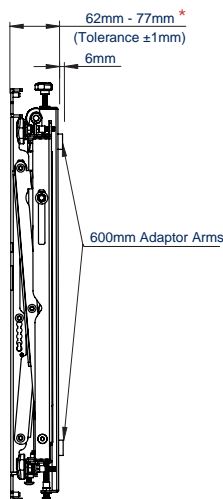

SIDE VIEW CLOSED

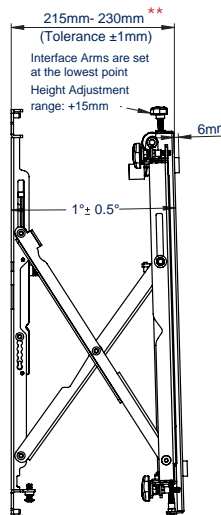

SIDE VIEW EXTENDED

*Total depth increased to **75.5mm** (+/-7.5mm micro-adjustment) when using VESA 600 x 400 adaptors
 Total depth increased to **228.5mm (+/-7.5mm micro-adjustment) when using VESA 600 x 400 adaptors

PACKING INFORMATION

COLOUR:	ORDER REF:	EAN CODE:	MASTER CARTON QTY:	INNER CARTON QTY:	MASTER CARTON WEIGHT:	MASTER CARTON CUBE:
Black	BT8312/B V2	5019318081231	1	0	15kg	0.044cbm

ORIGINAL DESIGN BY B-TECH - PATENT PENDING - REGISTERED DESIGN

RELATED PRODUCTS

<p>BT8312-SP</p>	<p>BT7822</p>	<p>BT7052</p>	<p>BT7850</p>
-------------------------	----------------------	----------------------	----------------------

Mounting Template Spacers for BT8312 speed up installation times

Heavy Duty Floor / Ceiling Mount can be used in conjunction with B-Tech poles and collars to create pole mounted solutions

50mm Accessory Collar for xing mounts & accessories to 50mm poles

50mm Diameter Poles are available in a choice of 6 lengths and can be used to create multiple pole mounted solutions

©2015 B-Tech Mounts Professional. All rights reserved. B-Tech is a registered trademark of B-Tech Mounts Professional. All other trademarks are the property of their respective owners. B-Tech Mounts Professional is not responsible for any damage caused by misuse or modification of the product. B-Tech Mounts Professional is not responsible for any damage caused by misuse or modification of the product. B-Tech Mounts Professional is not responsible for any damage caused by misuse or modification of the product. B-Tech Mounts Professional is not responsible for any damage caused by misuse or modification of the product.