

Dell EMC PowerEdge R6515

Installation and Service Manual

Notes, cautions, and warnings

 **NOTE:** A NOTE indicates important information that helps you make better use of your product.

 **CAUTION:** A CAUTION indicates either potential damage to hardware or loss of data and tells you how to avoid the problem.

 **WARNING:** A WARNING indicates a potential for property damage, personal injury, or death.

Chapter 1: About this document	7
Chapter 2: PowerEdge R6515 system overview	8
Front view of the system.....	8
Left control panel view.....	11
Right control panel view.....	12
Rear view of the system.....	13
Inside the system	14
Locating the Express Service Code and Service Tag.....	14
System information label.....	15
Rail sizing and rack compatibility matrix.....	19
Chapter 3: Initial system setup and configuration	20
Setting up the system.....	20
iDRAC configuration.....	20
Options to set up iDRAC IP address.....	20
Options to log in to iDRAC.....	21
Resources to install operating system.....	22
Options to download firmware	22
Options to download and install OS drivers	22
Downloading drivers and firmware.....	23
Chapter 4: Installing and removing system components	24
Safety instructions.....	24
Before working inside your system.....	25
After working inside your system.....	25
Recommended tools.....	25
Optional front bezel.....	26
Removing the front bezel.....	26
Installing the front bezel.....	26
System cover.....	27
Removing the system cover.....	27
Installing the system cover.....	28
Drive backplane cover.....	29
Removing the drive backplane cover.....	29
Installing the drive backplane cover.....	30
Air shroud.....	32
Removing the air shroud.....	32
Installing the air shroud.....	32
Cooling fan.....	33
Removing a cooling fan.....	33
Installing a cooling fan.....	34
Intrusion switch module.....	35
Removing the intrusion switch.....	35

Installing the intrusion switch.....	36
Drives.....	37
Removing a drive blank.....	37
Installing a drive blank.....	38
Removing the drive carrier.....	38
Installing the drive carrier.....	39
Removing the drive from the drive carrier.....	40
Installing the drive into the drive carrier.....	41
Drive backplane.....	42
Drive backplane.....	42
Removing the backplane	43
Installing the drive backplane.....	44
Cable routing.....	46
System memory.....	47
System memory guidelines.....	47
General memory module installation guidelines.....	49
Removing a memory module.....	52
Installing a memory module.....	53
Processor and heat sink.....	54
Removing a heat sink.....	54
Removing the AMD processor.....	55
Installing the AMD processor.....	57
Installing the heat sink.....	59
Expansion cards and expansion card risers.....	61
Expansion card installation guidelines.....	61
Removing the expansion card risers.....	64
Installing the expansion card risers.....	65
Removing expansion card from the expansion card riser.....	67
Installing an expansion card into the expansion card riser.....	69
Micro SD card.....	72
Removing the MicroSD card.....	72
Installing the MicroSD card.....	72
M.2 SSD module on BOSS-S1 adapter card.....	73
Removing the M.2 SSD module.....	73
Installing the M.2 SSD module.....	74
Optional IDSDM module.....	75
Removing the IDSDM module.....	75
Installing the IDSDM module.....	76
LOM riser card.....	77
Removing the LOM riser card.....	77
Installing the LOM riser card.....	79
Mini PERC card.....	81
Removing the mini PERC card.....	81
Installing the mini PERC card.....	82
System battery	84
Replacing the system battery.....	84
Optional internal USB memory key.....	85
Replacing optional internal USB memory key.....	85
VGA module.....	87
Removing the VGA module.....	87

Installing the VGA module.....	87
Optional optical drive.....	88
Removing the optical drive.....	88
Installing the optical drive.....	89
Power supply unit.....	90
Hot spare feature.....	90
Removing a power supply unit blank.....	91
Installing a power supply unit blank.....	91
Installing a power supply unit.....	92
Removing a power supply unit.....	93
Power interposer board.....	94
Removing the power interposer board.....	94
Installing the power interposer board.....	94
System board.....	95
Removing the system board.....	95
Installing the system board.....	96
Trusted Platform Module.....	98
Upgrading the Trusted Platform Module.....	98
Control panel.....	100
Removing the left control panel.....	100
Installing the left control panel.....	101
Removing the right control panel.....	102
Installing the right control panel.....	103
Chapter 5: Jumpers and connectors.....	105
System board connectors.....	106
System board jumper settings.....	107
Disabling a forgotten password.....	107
Chapter 6: System diagnostics and indicator codes.....	108
Status LED indicators.....	108
System health and system ID indicator codes.....	109
iDRAC Quick Sync 2 indicator codes.....	110
iDRAC Direct LED indicator codes.....	110
LCD panel.....	111
Viewing Home screen.....	111
Setup menu.....	112
View menu.....	112
NIC indicator codes.....	113
Power supply unit indicator codes.....	113
Drive indicator codes.....	114
Using system diagnostics.....	115
Dell Embedded System Diagnostics.....	115
Chapter 7: Getting help.....	117
Recycling or End-of-Life service information.....	117
Contacting Dell.....	117
Accessing system information by using QRL.....	117
Quick Resource Locator for PowerEdge R6515 system.....	118

Receiving automated support with SupportAssist118

Chapter 8: Documentation resources.....119

About this document

This document provides an overview about the system, information about installing and replacing components, diagnostic tools, and guidelines to be followed while installing certain components.

PowerEdge R6515 system overview

The PowerEdge R6515 system is a 1U server that supports:

- One AMD EPYC 7002 and 7003 series processor
- 16 DIMM slots
- Two redundant AC power supply units
- Up to 4 x 3.5-inch, 8 x 2.5-inch SAS/SATA drives, 10 x 2.5-inch drives (with 8 SAS/SATA/ NVMe drives + 2 NVMe drives) or 10x 2.5-inch NVMe drives only.

i NOTE: For more information about how to hot swap NVMe PCIe SSD U.2 device, see the *Dell Express Flash NVMe PCIe SSD User's Guide* at <https://www.dell.com/support> > **Browse all Products** > **Data Center Infrastructure** > **Storage Adapters & Controllers** > **Dell PowerEdge Express Flash NVMe PCIe SSD** > **Documentation** > **Manuals and Documents**.

i NOTE: All instances of SAS, SATA drives are referred to as drives in this document, unless specified otherwise.

⚠ WARNING: Consumer-Grade GPU should not be installed or used in the Enterprise Server products.

For more information, see the Dell EMC PowerEdge R6515 Technical Specifications on the product documentation page.

Topics:

- [Front view of the system](#)
- [Rear view of the system](#)
- [Inside the system](#)
- [Locating the Express Service Code and Service Tag](#)
- [System information label](#)
- [Rail sizing and rack compatibility matrix](#)

Front view of the system



Figure 1. Front view of 4 x 3.5-inch drive system

Table 1. Features available on the front of the system

Item	Ports, panels, and slots	Icon	Description
1	Left control panel	N/A	<p>Contains the system health, system ID, status LED, and the iDRAC Quick Sync 2 (wireless) indicator.</p> <p>i NOTE: The iDRAC Quick Sync 2 indicator is available only on certain configurations.</p> <ul style="list-style-type: none"> • Status LED: Enables you to identify any failed hardware components. There are up to five status LEDs and an overall

Table 1. Features available on the front of the system (continued)

Item	Ports, panels, and slots	Icon	Description
			<p>system health LED (Chassis health and system ID) bar. For more information, see the Status LED indicators section.</p> <ul style="list-style-type: none"> Quick Sync 2 (wireless): Indicates a Quick Sync enabled system. The Quick Sync feature is optional. This feature allows management of the system by using mobile devices called as OpenManage Mobile (OMM) feature. Using iDRAC Quick Sync 2 with OpenManage Mobile (OMM) aggregates hardware or firmware inventory and various system level diagnostic and error information that can be used in troubleshooting the system. For more information, see the <i>Integrated Dell Remote Access Controller User's Guide</i> available at https://www.dell.com/idracmanuals
2	Optical drive (optional)	N/A	One optional slim SATA DVD-ROM drive or DVD+/-RW drive.
3	VGA port		Enables you to connect a display device to the system.
4	Right control panel	N/A	Contains the power button, USB port, iDRAC Direct micro port, and the iDRAC Direct status LED.
5	Information tag		The Information tag is a slide-out label panel that contains system information such as Service Tag, NIC, MAC address, and so on. If you have opted for the secure default access to iDRAC, the Information tag also contains the iDRAC secure default password.
6	Drive (4)	N/A	Enables you to install drives that are supported on your system.

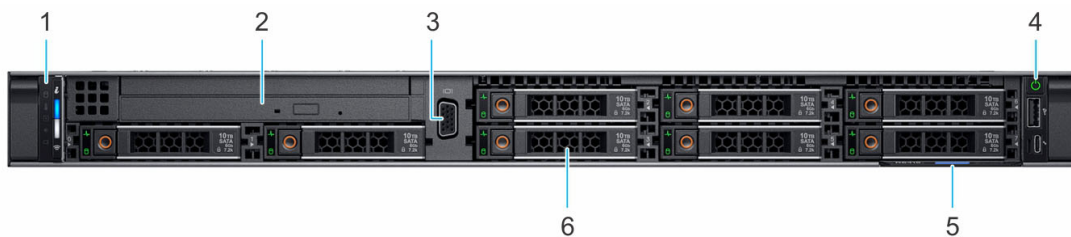



Figure 2. Front view of 8 x 2.5-inch drive system

Table 2. Features available on the front of the system

Item	Ports, panels, and slots	Icon	Description
1	Left control panel	N/A	<p>Contains the system health, system ID, status LED, and the iDRAC Quick Sync 2 (wireless) indicator.</p> <p>i NOTE: The iDRAC Quick Sync 2 indicator is available only on certain configurations.</p> <ul style="list-style-type: none"> Status LED: Enables you to identify any failed hardware components. There are up to five status LEDs and an overall system health LED (Chassis health and system ID) bar. For more information, see the Status LED indicators section. Quick Sync 2 (wireless): Indicates a Quick Sync enabled system. The Quick Sync feature is optional. This feature allows management of the system by using mobile devices called as OpenManage Mobile (OMM) feature. Using iDRAC Quick Sync 2 with OpenManage Mobile (OMM) aggregates hardware or firmware inventory and various system level diagnostic and error information that can be used in

Table 2. Features available on the front of the system (continued)

Item	Ports, panels, and slots	Icon	Description
			troubleshooting the system. For more information, see the <i>Integrated Dell Remote Access Controller User's Guide</i> available at https://www.dell.com/idracmanuals
2	Optical drive (optional)	N/A	One optional slim SATA DVD-ROM drive or DVD+/-RW drive.
3	VGA port		Enables you to connect a display device to the system.
4	Right control panel	N/A	Contains the power button, USB port, iDRAC Direct micro port, and the iDRAC Direct status LED.
5	Information tag		The Information tag is a slide-out label panel that contains system information such as Service Tag, NIC, MAC address, and so on. If you have opted for the secure default access to iDRAC, the Information tag also contains the iDRAC secure default password.
6	Drive (8)	N/A	Enables you to install drives that are supported on your system.

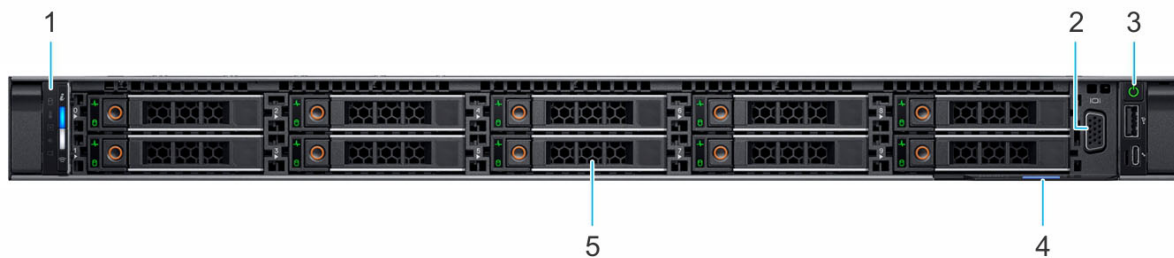

Figure 3. Front view of 10 x 2.5-inch drive system

Table 3. Features available on the front of the system

Item	Ports, panels, and slots	Icon	Description
1	Left control panel	N/A	Contains the system health, system ID, status LED, and the iDRAC Quick Sync 2 (wireless) indicator. NOTE: The iDRAC Quick Sync 2 indicator is available only on certain configurations. <ul style="list-style-type: none"> • Status LED: Enables you to identify any failed hardware components. There are up to five status LEDs and an overall system health LED (Chassis health and system ID) bar. For more information, see the Status LED indicators section. • Quick Sync 2 (wireless): Indicates a Quick Sync enabled system. The Quick Sync feature is optional. This feature allows management of the system by using mobile devices called as OpenManage Mobile (OMM) feature. Using iDRAC Quick Sync 2 with OpenManage Mobile (OMM) aggregates hardware or firmware inventory and various system level diagnostic and error information that can be used in troubleshooting the system. For more information, see the <i>Integrated Dell Remote Access Controller User's Guide</i> available at https://www.dell.com/idracmanuals
2	VGA port		Enables you to connect a display device to the system.
3	Right control panel	N/A	Contains the power button, USB port, iDRAC Direct micro port, and the iDRAC Direct status LED.

Table 3. Features available on the front of the system (continued)

Item	Ports, panels, and slots	Icon	Description
4	Information tag		The Information tag is a slide-out label panel that contains system information such as Service Tag, NIC, MAC address, and so on. If you have opted for the secure default access to iDRAC, the Information tag also contains the iDRAC secure default password.
5	Drive (10)	N/A	Enables you to install drives that are supported on your system.

For more information, see the Dell EMC PowerEdge R6515 Technical Specifications on the product documentation page.

Left control panel view

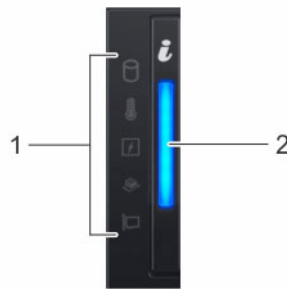

Figure 4. Left control panel without optional iDRAC Quick Sync 2.0 indicator

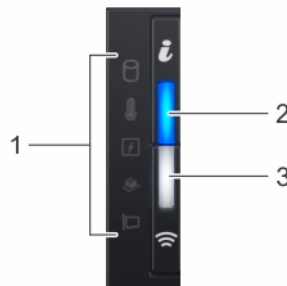

Figure 5. Left control panel with optional iDRAC Quick Sync 2.0 indicator

Table 4. Left control panel

Item	Indicator, button, or connector	Icon	Description
1	Status LED indicators	N/A	Indicates the status of the system. For more information, see the Status LED indicators section.
2	System health and system ID indicator		Indicates the system health. For more information, see the System health and system ID indicator codes section.
3	iDRAC Quick Sync 2 wireless indicator (optional)		Indicates if the iDRAC Quick Sync 2 wireless option is activated. The Quick Sync 2 feature allows management of the system using mobile devices. This feature aggregates hardware/firmware inventory and various system level diagnostic/error information that can be used in troubleshooting the system. You can access system inventory, Dell Lifecycle Controller logs or system logs, system health status, and also configure iDRAC, BIOS, and networking parameters. You can also launch the virtual Keyboard, Video, and Mouse (KVM) viewer and virtual Kernel-based Virtual Machine (KVM), on

Table 4. Left control panel (continued)

Item	Indicator, button, or connector	Icon	Description
			a supported mobile device. For more information, see the Integrated Dell Remote Access Controller User's Guide at www.dell.com/poweredgemanuals

NOTE: For more information about the indicator codes, see the [System diagnostics and indicator codes](#) section.

Right control panel view

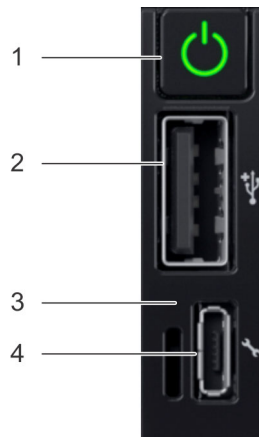

Figure 6. Right control panel

Table 5. Right control panel

Item	Indicator or button	Icon	Description
1	Power button		Indicates if the system is powered on or off. Press the power button to manually power on or off the system. NOTE: Press the power button to gracefully shut down an ACPI-compliant operating system.
2	USB 2.0-compliant port		The USB port is a 4-pin connector and 2.0-compliant. This port enables you to connect USB devices to the system.
3	iDRAC Direct LED indicator	N/A	The iDRAC Direct LED indicator lights up to indicate that the iDRAC Direct port is actively connected to a device.
4	iDRAC Direct port (Micro-AB USB)		The iDRAC Direct port (Micro-AB USB) enables you to access the iDRAC direct Micro-AB USB features. For more information, see the https://www.dell.com/idracmanuals . NOTE: You can configure iDRAC Direct by using a USB to micro USB (type AB) cable, which you can connect to your laptop or tablet. Cable length should not exceed 3 feet (0.91 meters). Performance could be affected by cable quality.

NOTE: For more information on the ports, see the Dell EMC PowerEdge R6515 Technical Specifications.

Rear view of the system

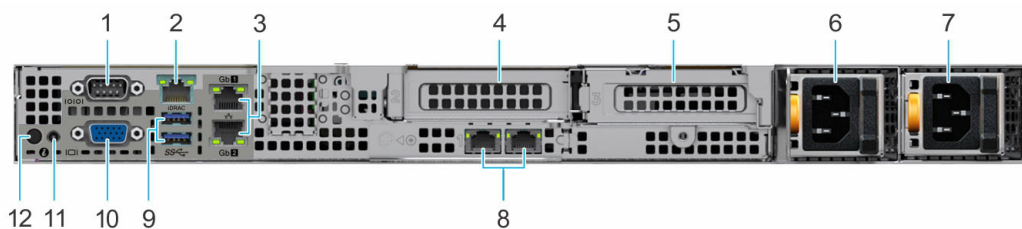

Figure 7. Rear view of the system

Table 6. Rear view of the system

Item	Ports, panels, or slots	Icon	Description
1	Serial port		Enables you to connect a serial device to the system.
2	iDRAC dedicated port		Enables you to remotely access iDRAC. For more information, see the iDRAC User's Guide at www.dell.com/poweredgedmanuals .
3	Ethernet ports (2)		The Ethernet ports that are integrated on the system board provide network connectivity. These NIC ports can also be shared with iDRAC when iDRAC network settings is set to shared mode.
4	PCIe expansion card riser 1A (slot 2)	N/A	The expansion card riser enables you to connect PCI Express expansion cards.
5	PCIe expansion card riser 2 (slot 3)	N/A	The expansion card riser enables you to connect PCI Express expansion cards.
6	Power supply unit (PSU 1)	N/A	For information on the PSU configurations, see the Dell EMC PowerEdge R6515 Technical Specifications on the product documentation page.
7	Power supply unit (PSU 2)	N/A	For information on the PSU configurations, see the Dell EMC PowerEdge R6515 Technical Specifications on the product documentation page.
8	LOM Riser Ethernet port (2) (Optional)	N/A	The NIC ports that are integrated on the LAN on Motherboard (LOM) riser provide network connectivity.
9	USB 3.0 port (2)		These USB ports support USB 3.0.
10	VGA port		Enables you to connect a display device to the system.
11	System status indicator cable port	N/A	Enables you to connect the status indicator cable and view system status when the CMA is installed.
12	System identification button		<p>Press the system ID button:</p> <ul style="list-style-type: none"> To locate a particular system within a rack. To turn the system ID on or off. <p>To reset iDRAC, press and hold the button for 16 seconds.</p> <p>NOTE:</p> <ul style="list-style-type: none"> To reset iDRAC using system ID, ensure that the system ID button is enabled in the iDRAC setup. If the system stops responding during POST, press and hold the system ID button (for more than five seconds) to enter the BIOS progress mode.

For information on the PSU configurations, see the Dell EMC PowerEdge R6515 Technical Specifications on the product documentation page.

Inside the system

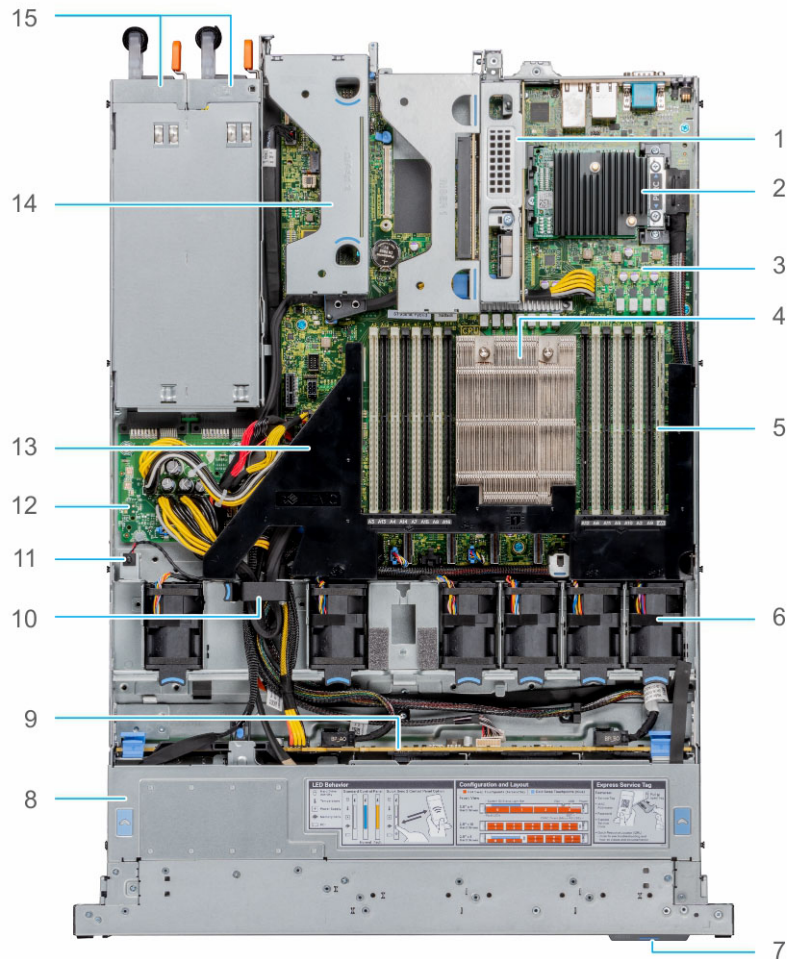

Figure 8. Inside the system

- | | |
|------------------------|----------------------------|
| 1. Riser 1A | 2. Mini PERC card |
| 3. System board | 4. Heat sink |
| 5. Memory module slots | 6. Fan |
| 7. Information tag | 8. Backplane cover |
| 9. Backplane | 10. Cable retention latch |
| 11. Intrusion switch | 12. Power interposer board |
| 13. Air shroud | 14. Riser 2 |
| 15. PSU 1 and PSU 2 | |

Locating the Express Service Code and Service Tag

The unique Express Service Code and Service Tag are used to identify the system.

The information tag is located on the front of the system that includes system information such as Service Tag, Express Service Code, Manufacture date, NIC, MAC address, QRL label, and so on. If you have opted for the secure default access to iDRAC, the Information tag also contains the iDRAC secure default password. If you have opted for iDRAC Quick Sync 2, the Information tag also contains the OpenManage Mobile (OMM) label, where administrators can configure, monitor, and troubleshoot the PowerEdge servers.

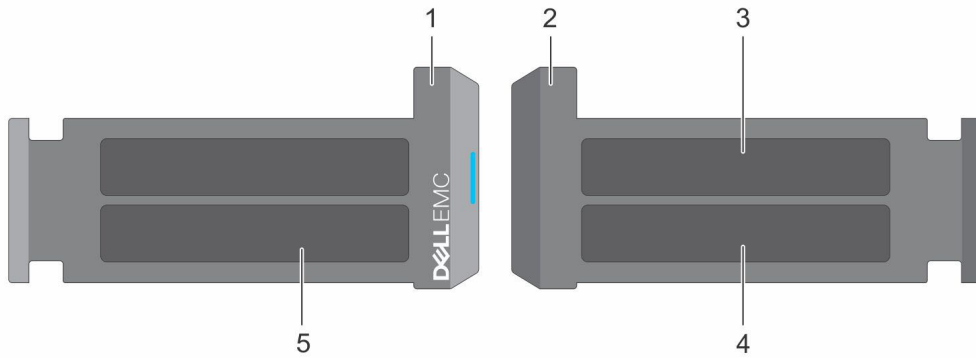

Figure 9. Locating the Express Service Code and Service tag

1. Information tag (front view)
2. Information tag (back view)
3. OpenManage Mobile (OMM) label
4. iDRAC MAC address and iDRAC secure password label
5. Service Tag, Express Service Code, QRL label

The Mini Enterprise Service Tag (MEST) label is located on the rear of the system that includes Service Tag (ST), Express Service Code (Exp Svc Code), and Manufacture Date (Mfg. Date). The Exp Svc Code is used by Dell EMC to route support calls to the appropriate personnel.

Alternatively, the Service Tag information is located on a label on left wall of the chassis.

System information label

The system information label is located on back side of the system cover.

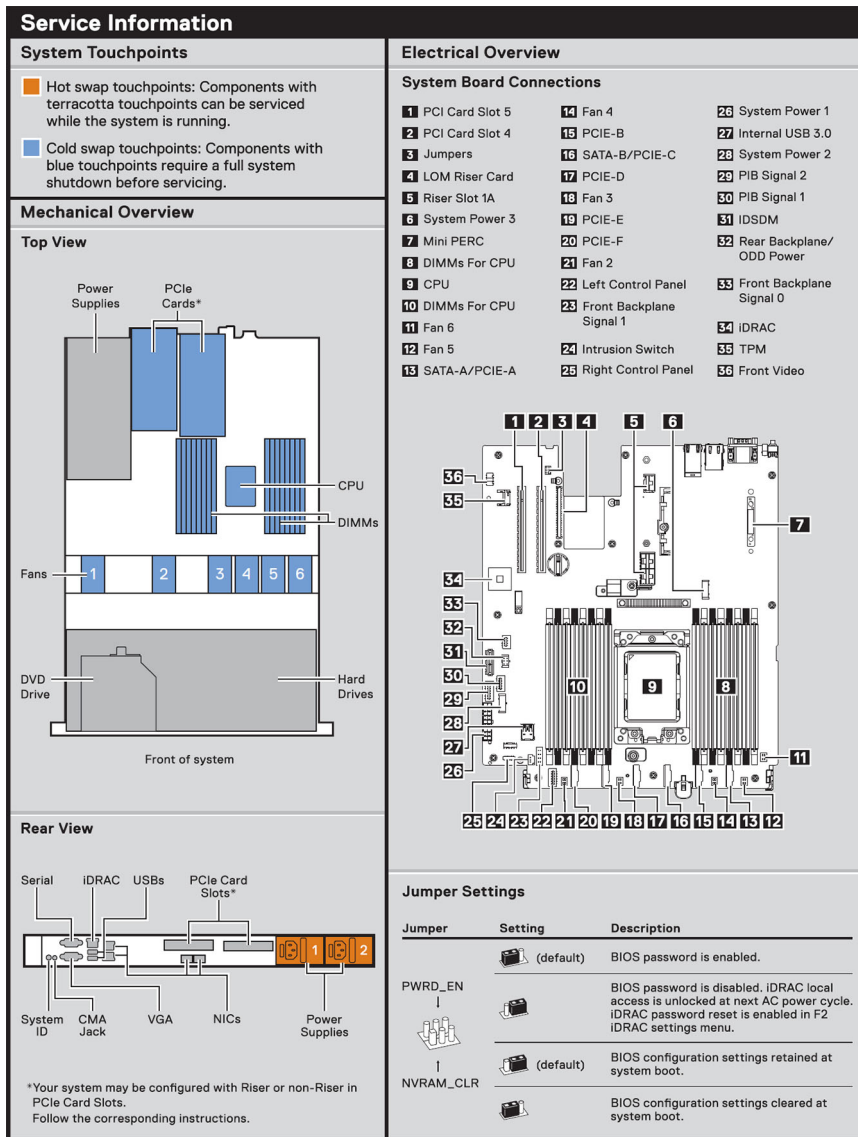
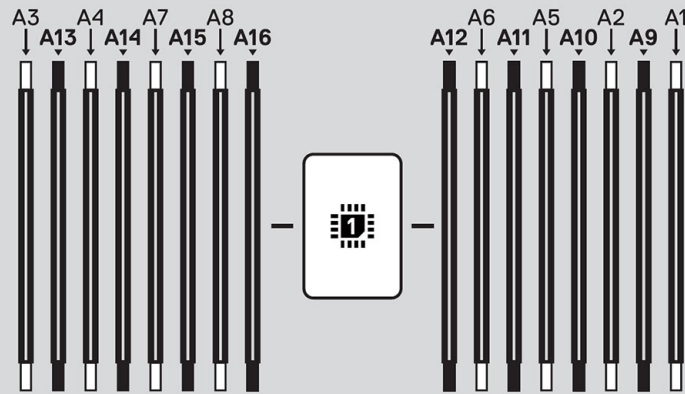

Figure 10. Service information

Memory Information

 **Caution:** Memory (DIMMs) and CPUs may be hot during servicing.



Memory Population

Configuration	Sequence
Memory-Optimized	1, 2, 3, 4, 5, 6, 7, 8, 9, 10, 11, 12, 13, 14, 15, 16

Latest population rules are documented in the *Installation and Service Manual*.

Figure 11. Memory information

⚠ Caution: Many repairs may only be done by a certified service technician. You should only perform troubleshooting and simple repairs as authorized in your product documentation, or as directed by the online or telephone service and support team. Damage due to servicing that is not authorized by Dell is not covered by your warranty. Read and follow the safety instructions that came with the product.

To learn more about this Dell product or to order additional or replacement parts, go to Dell.com/support

Copyright © 2019 Dell Inc. or its subsidiaries. All Rights Reserved. Rev A00. Label Part No. 5MTWC

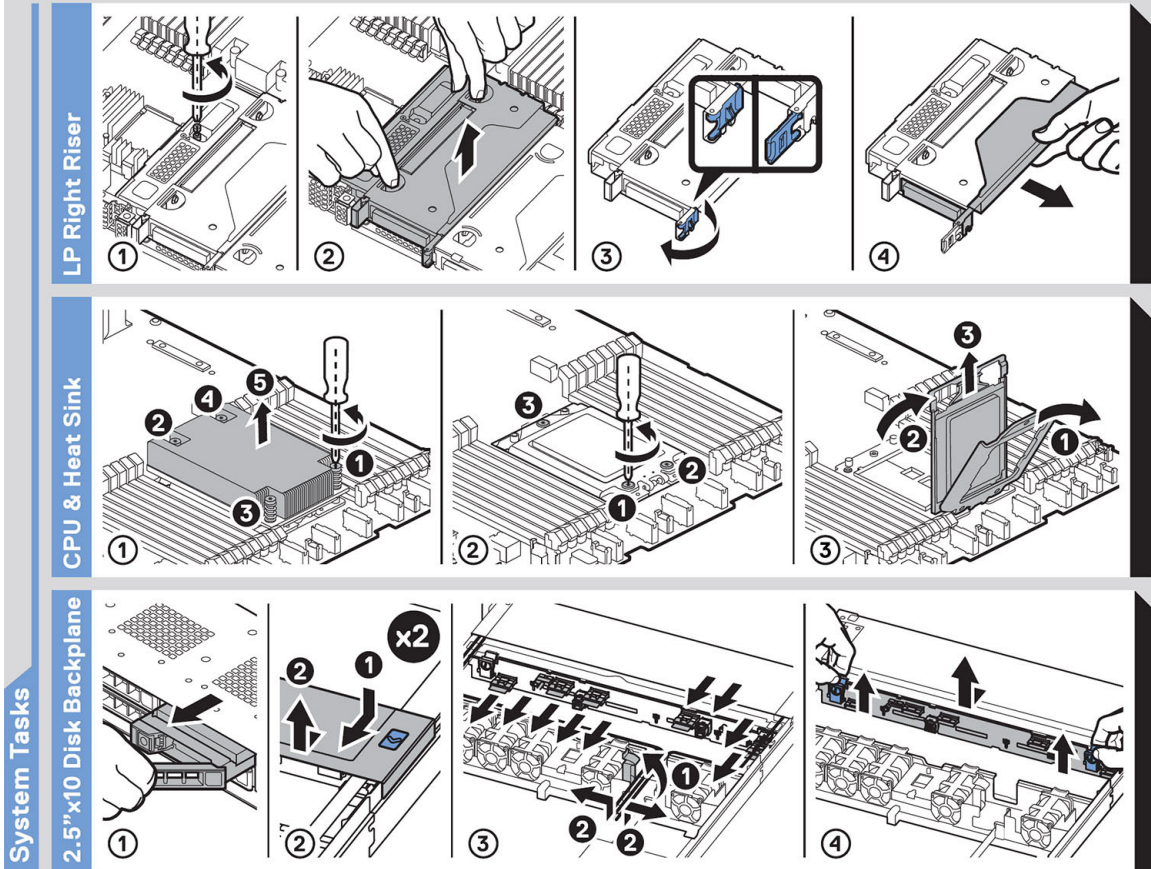

Figure 12. System tasks

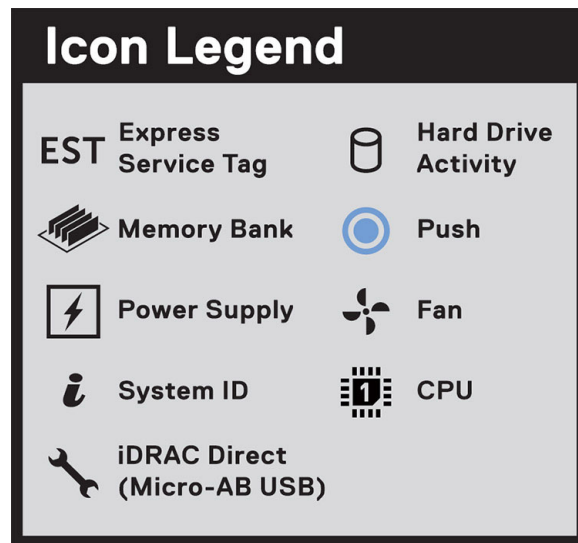

Figure 13. Icon Legend



Figure 14. R6515 QRL

Rail sizing and rack compatibility matrix

For specific information about the rail solutions compatible with your system, see the *Dell EMC Enterprise Systems Rail Sizing and Rack Compatibility Matrix* available at https://i.dell.com/sites/csdocuments/Business_solutions_engineering-Docs_Documents/en/rail-rack-matrix.pdf.

The document provides the information that is listed below:

- Specific details about rail types and their functionalities
- Rail adjustability ranges for various rack mounting flange types
- Rail depth with and without cable management accessories
- Rack types that are supported for various rack mounting flange types

Initial system setup and configuration

This section describes the tasks for initial setup and configuration of the Dell EMC system. The sections provide general steps that you must complete to set up the system and the reference guides for detailed information.

Topics:

- [Setting up the system](#)
- [iDRAC configuration](#)
- [Resources to install operating system](#)

Setting up the system

Perform the following steps to set up the system:

Steps

1. Unpack the system.
2. Install the system into the rack. For more information, see the rail installation and cable management accessory guides relevant to your rail and cable management solution at www.dell.com/poweredgemanuals.
3. Connect the peripherals to the system and the system to the electrical outlet.
4. Power on the system by pressing the power button.

For more information about setting up the system, see the *Getting Started Guide* that is shipped with your system.

For information on how to manage basic settings and features of the system, see the Dell EMC PowerEdge R6515 BIOS and UEFI Reference Guide on the product documentation page.

iDRAC configuration

The Integrated Dell Remote Access Controller (iDRAC) is designed to make you more productive as a system administrator and improve the overall availability of Dell EMC servers. iDRAC alerts you to system issues, helps you to perform remote management, and reduces the need for physical access to the system.

Options to set up iDRAC IP address

To enable communication between your system and iDRAC, you must first configure the network settings based on your network infrastructure. The network settings option is set to **DHCP**, by default.

 **NOTE:** For static IP configuration, you must request for the setting at the time of purchase.

You can set up the iDRAC IP address using one of the following interfaces. For information about how to set up iDRAC IP address, see the documentation links provided in the table.

Table 7. Interfaces to set up iDRAC IP address

Interface	Documentation links
iDRAC Settings utility	<p><i>Integrated Dell Remote Access Controller User's Guide</i> at https://www.dell.com/idracmanuals or for system specific <i>Integrated Dell Remote Access Controller User's Guide</i>, go to https://www.dell.com/poweredgemanuals > Product Support page of your system > Manuals & documents.</p> <p> NOTE: To determine the most recent iDRAC release for your platform and for latest documentation version,</p>

Table 7. Interfaces to set up iDRAC IP address (continued)

Interface	Documentation links
	see KB article https://www.dell.com/support/article/sln308699 .
OpenManage Deployment Toolkit	<i>Dell EMC OpenManage Deployment Toolkit User's Guide</i> available at https://www.dell.com/openmanagemanuals > Open Manage Deployment Toolkit.
Lifecycle Controller	<i>Lifecycle Controller User's Guide</i> at https://www.dell.com/idracmanuals or for system specific <i>Lifecycle Controller User's Guide</i> , go to https://www.dell.com/poweredgemanuals > Product Support page of your system > Manuals & documents . <i>NOTE:</i> To determine the most recent iDRAC release for your platform and for latest documentation version, see KB article https://www.dell.com/support/article/sln308699 .
Server LCD panel	LCD panel section.
iDRAC Direct and Quick Sync 2 (optional)	<i>Integrated Dell Remote Access Controller User's Guide</i> at https://www.dell.com/idracmanuals or for system specific <i>Integrated Dell Remote Access Controller User's Guide</i> , go to https://www.dell.com/poweredgemanuals > Product Support page of your system > Manuals & documents . <i>NOTE:</i> To determine the most recent iDRAC release for your platform and for latest documentation version, see KB article https://www.dell.com/support/article/sln308699 .

NOTE: To access iDRAC, ensure that you connect the ethernet cable to the iDRAC9 dedicated network port or use iDRAC Direct port by using the USB cable. You can also access iDRAC through the shared LOM mode, if you have opted for a system that has the shared LOM mode enabled.

Options to log in to iDRAC

To log in to the iDRAC Web User Interface, open a browser and enter the IP address.

You can log in to iDRAC as:

- iDRAC user
- Microsoft Active Directory user
- Lightweight Directory Access Protocol (LDAP) user

In the log in screen displayed, if you have opted for secure default access to iDRAC, enter the iDRAC secure default password available on back side of the Information Tag. If you have not opted for secure default access to iDRAC, enter the default user name and password – `root` and `calvin`. You can also log in by using your Single Sign-On or Smart Card.

NOTE: Ensure that you change the default username and password after setting up the iDRAC IP address.

For more information about logging in to the iDRAC and iDRAC licenses, see the latest *Integrated Dell Remote Access Controller User's Guide* at www.dell.com/idracmanuals.

NOTE: To determine the most recent iDRAC release for your platform and for latest documentation version, see KB article <https://www.dell.com/support/article/sln308699>.

You can also access iDRAC using command-line protocol - RACADM. For more information, see the *iDRAC with Lifecycle Controller RACADM CLI Guide* available at www.dell.com/idracmanuals.

You can also access iDRAC using automation tool - Redfish API. For more information, see the *iDRAC9 with Lifecycle Controller Redfish API Guide* available at <https://www.dell.com/idracmanuals>.

Resources to install operating system

If the system is shipped without an operating system, you can install a supported operating system by using one of the resources provided in the table. For information about how to install the operating system, see the documentation links provided in the table.

Table 8. Resources to install the operating system

Resource	Documentation links
iDRAC	<i>Integrated Dell Remote Access Controller User's Guide</i> at https://www.dell.com/idracmanuals or for system specific <i>Integrated Dell Remote Access Controller User's Guide</i> , go to https://www.dell.com/poweredgemanuals > Product Support page of your system > Manuals & documents . <i>NOTE:</i> To determine the most recent iDRAC release for your platform and for latest documentation version, see KB article at https://www.dell.com/support/article/sln308699 .
Lifecycle Controller	<i>Lifecycle Controller User's Guide</i> at https://www.dell.com/idracmanuals or for system specific <i>Lifecycle Controller User's Guide</i> , go to https://www.dell.com/poweredgemanuals > Product Support page of your system > Manuals & documents . Dell recommends using Lifecycle Controller to install the OS, since all required drivers are installed to the system. <i>NOTE:</i> To determine the most recent iDRAC release for your platform and for latest documentation version, see KB article at https://www.dell.com/support/article/sln308699 .
OpenManage Deployment Toolkit	www.dell.com/openmanagemanuals > OpenManage Deployment Toolkit
Dell certified VMware ESXi	www.dell.com/virtualizationsolutions

NOTE: For more information about Installation and How-to videos for supported operating systems on PowerEdge system see, [Supported Operating Systems for Dell EMC PowerEdge systems](#).

Options to download firmware

You can download firmware from the Dell support site. For information, see the [Downloading drivers and firmware](#) section.

You can also choose any one of the following options to download the firmware. For information about how to download the firmware, see the documentation links provided in the table.

Table 9. Options to download firmware

Option	Documentation link
Using Dell Remote Access Controller Lifecycle Controller (iDRAC with LC)	www.dell.com/idracmanuals
Using Dell Repository Manager (DRM)	www.dell.com/openmanagemanuals > Repository Manager
Using Dell Server Update Utility (SUU)	www.dell.com/openmanagemanuals > Server Update Utility
Using Dell OpenManage Deployment Toolkit (DTK)	www.dell.com/openmanagemanuals > OpenManage Deployment Toolkit
Using iDRAC virtual media	www.dell.com/idracmanuals

Options to download and install OS drivers

You can choose any one of the following options to download and install OS drivers. For information about how to download or install OS drivers, see the documentation links provided in the table.

Table 10. Options to download and install OS drivers

Option	Documentation
Dell EMC support site	Downloading drivers and firmware section.
iDRAC virtual media	<i>Integrated Dell Remote Access Controller User's Guide</i> at https://www.dell.com/idracmanuals or for system specific <i>Integrated Dell Remote Access Controller User's Guide</i> , go to https://www.dell.com/poweredgemanuals > Product Support page of your system > Manuals & documents .  NOTE: To determine the most recent iDRAC release for your platform and for latest documentation version, see https://www.dell.com/support/article/sln308699 .

Downloading drivers and firmware

It is recommended that you download and install the latest BIOS, drivers, and systems management firmware on the system.

Prerequisites

Ensure that you clear the web browser cache before downloading the drivers and firmware.

Steps

1. Go to www.dell.com/support/drivers.
2. Enter the Service Tag of the system in the **Enter a Dell Service Tag, Dell EMC Product ID or Model** field, and then press Enter.
 **NOTE:** If you do not have the Service Tag, select **Detect PC** to automatically detect the Service Tag, or click **Browse all products**, and navigate to your product.
3. On the displayed product page, click **Drivers & Downloads**.
On the **Drivers & Downloads** page, all drivers that are applicable to the system are displayed.
4. Download the drivers to a USB drive, CD, DVD or local machine.

Installing and removing system components

Topics:

- Safety instructions
- Before working inside your system
- After working inside your system
- Recommended tools
- Optional front bezel
- System cover
- Drive backplane cover
- Air shroud
- Cooling fan
- Intrusion switch module
- Drives
- Drive backplane
- Cable routing
- System memory
- Processor and heat sink
- Expansion cards and expansion card risers
- Micro SD card
- M.2 SSD module on BOSS-S1 adapter card
- Optional IDSDM module
- LOM riser card
- Mini PERC card
- System battery
- Optional internal USB memory key
- VGA module
- Optional optical drive
- Power supply unit
- Power interposer board
- System board
- Trusted Platform Module
- Control panel

Safety instructions

 **NOTE:** To avoid injury, do not lift the system on your own. Get others to assist you.

 **WARNING:** Opening or removing the system cover while the system is turned on may expose you to a risk of electric shock..

 **CAUTION:** Many repairs may only be done by a certified service technician. You should only perform troubleshooting and simple repairs as authorized in your product documentation, or as directed by the online or telephone service and support team. Damage due to servicing that is not authorized by Dell is not covered by your warranty. Read and follow the safety instructions that are shipped with your product.

 **CAUTION:** To ensure proper operation and cooling, all system bays and fans must be always populated with a component or a blank.

- NOTE:** It is recommended that you always use an antistatic mat and antistatic strap while working on components inside the system.
- NOTE:** While replacing the hot swappable PSU, after next server boot; the new PSU automatically updates to the same firmware and configuration of the replaced one. For more information about the Part replacement configuration, see the *Lifecycle Controller User's Guide* at <https://www.dell.com/idracmanuals>
- NOTE:** While replacing faulty storage controller/FC/NIC card with the same type of card, after you power on the system; the new card automatically updates to the same firmware and configuration of the faulty one. For more information about the Part replacement configuration, see the *Lifecycle Controller User's Guide* at <https://www.dell.com/idracmanuals>
- NOTE:** Ensure to install the latest iDRAC 4.4x version or any later versions to support the 700 W PSU.
- NOTE:** For detailed information on cabling the PERC 11 cards, see the system-specific owner's manual at Installation and Service Manual available at <https://www.dell.com/poweredgemanuals>

Before working inside your system

Prerequisites

Follow the safety guidelines listed in [Safety instructions](#).

Steps

1. Power off the system and all attached peripherals.
2. Disconnect the system from the electrical outlet, and disconnect the peripherals.
3. If applicable, remove the system from the rack.
For more information, see the *Rail Installation Guide* relevant to your rail solutions at www.dell.com/poweredgemanuals.
4. Remove the system cover.

After working inside your system

Prerequisites

Follow the safety guidelines listed in [Safety instructions](#).

Steps

1. Replace the system cover.
2. If applicable, install the system into the rack.
For more information, see the *Rail Installation Guide* relevant to your rail solutions at www.dell.com/poweredgemanuals.
3. Reconnect the peripherals and connect the system to the electrical outlet, and then power on the system.

Recommended tools

You need the following tools to perform the removal and installation procedures:

- Key to the bezel lock. The key is required only if your system includes a bezel.
- Phillips #1 screwdriver
- Phillips #2 screwdriver
- Torx #T20 screwdriver
- 5mm hex nut screwdriver
- Plastic scribe
- 1/4 inch flat blade screwdriver
- Wrist grounding strap connected to the ground
- ESD mat

Optional front bezel

i | **NOTE:** LCD panel is optional on the front bezel. If the front bezel has an LCD panel, see [LCD panel](#) section.

Removing the front bezel

The procedure to remove the front bezel with and without the LCD panel is the same.

Prerequisites

1. Follow the safety guidelines listed in the [Safety instructions](#).
2. Keep the bezel key handy.

i | **NOTE:** The bezel key is part of the LCD bezel package.

Steps

1. Unlock the bezel.
2. Press the release button, and disengage the left end of the bezel.
3. Unhook the right end, and remove the bezel.



Figure 15. Removing the front bezel with the LCD panel

Next steps

Replace the bezel.

Installing the front bezel

The procedure to install the front bezel with and without the LCD panel is the same.

Prerequisites

1. Follow the safety guidelines listed in the [Safety instructions](#).
2. Locate and remove the bezel key.

i | **NOTE:** The bezel key is part of the LCD bezel package.

Steps

1. Align and insert the tabs on the bezel into the slots on the system.
2. Press the bezel until the release button clicks in place.
3. Lock the bezel.



Figure 16. Installing the front bezel with the LCD panel

System cover

Removing the system cover

Prerequisites

1. Follow the safety guidelines listed in the [Safety instructions](#).
2. Power off the system, and any attached peripherals.
3. Disconnect the system from the electrical outlet and peripherals.

Steps

1. Use a 1/4 inch flat head or a Phillips #2 screwdriver to rotate the lock counterclockwise to the unlock position.
2. Lift the release latch until the system cover slides back.
3. Lift the cover from the system.



Figure 17. Removing the system cover

Next steps

Replace the system cover.

Installing the system cover

Prerequisites

1. Follow the safety guidelines listed in the [Safety instructions](#).
2. Follow the procedure listed in [Before working inside your system](#).
3. Ensure that all internal cables are connected and routed properly, and no tools or extra parts are left inside the system.

Steps

1. Align the tabs on the system cover with the guide slots on the system.
2. Close the system cover release latch.
3. Using a 1/4 inch flat head or Phillips #2 screwdriver, rotate the lock clockwise to the lock position.



Figure 18. Installing the system cover

Next steps

Follow the procedure listed in [After working inside your system](#).

Drive backplane cover

Removing the drive backplane cover

Prerequisites

1. Follow the safety guidelines listed in the [Safety instructions](#).
2. Follow the procedure listed in the [Before working inside your system](#).

Steps

1. Slide the backplane cover in the direction of the arrows marked on the backplane cover.
2. Lift the backplane cover from the system.

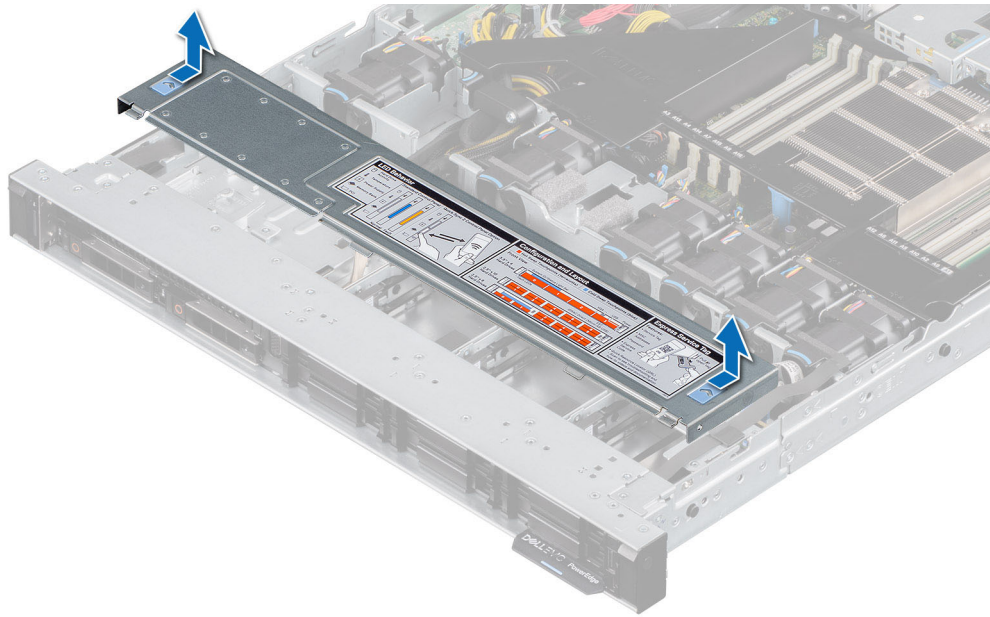

Figure 19. Removing the drive backplane cover

Next steps

Replace the backplane cover.

Installing the drive backplane cover

Prerequisites

Follow the safety guidelines listed in the [Safety instructions](#).

Steps

1. Align the backplane cover with the guide slots on the system.
2. Slide the backplane cover toward the front of the system until the backplane cover fits into place.

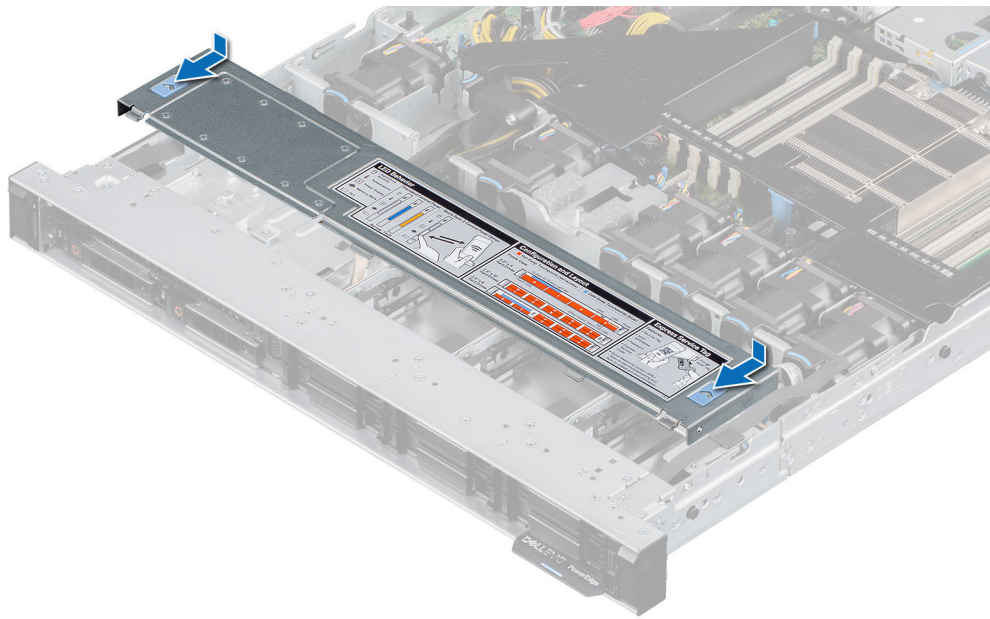

Figure 20. Installing the drive backplane cover

Next steps

Follow the procedure listed in [After working inside your system.](#)

Air shroud

Removing the air shroud

Prerequisites

CAUTION: Never operate your system with the air shroud removed. The system may get overheated quickly, resulting in shutdown of the system and loss of data.

1. Follow the safety guidelines listed in the [Safety instructions](#).
2. Follow the procedure listed in the [Before working inside your system](#).

Steps

Hold the air shroud touch points at both ends and lift the air shroud out of the system.

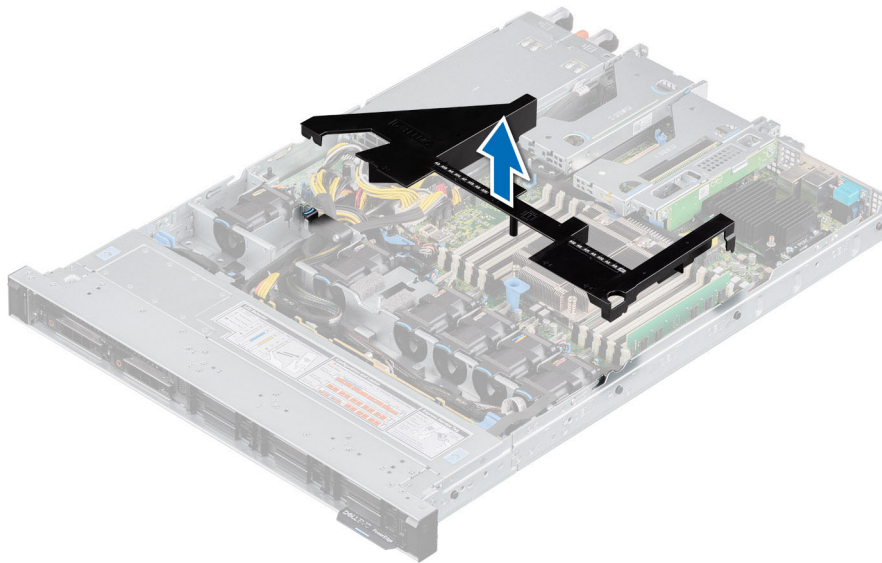

Figure 21. Removing the air shroud

Next steps

[Replace the air shroud.](#)

Installing the air shroud

Prerequisites

1. Follow the safety guidelines listed in the [Safety instructions](#).
2. Follow the procedure listed in the [Before working inside your system](#).

Steps

1. Align the slot on the air shroud with the standoff on the chassis.
2. Lower the air shroud into the system until it is firmly seated.

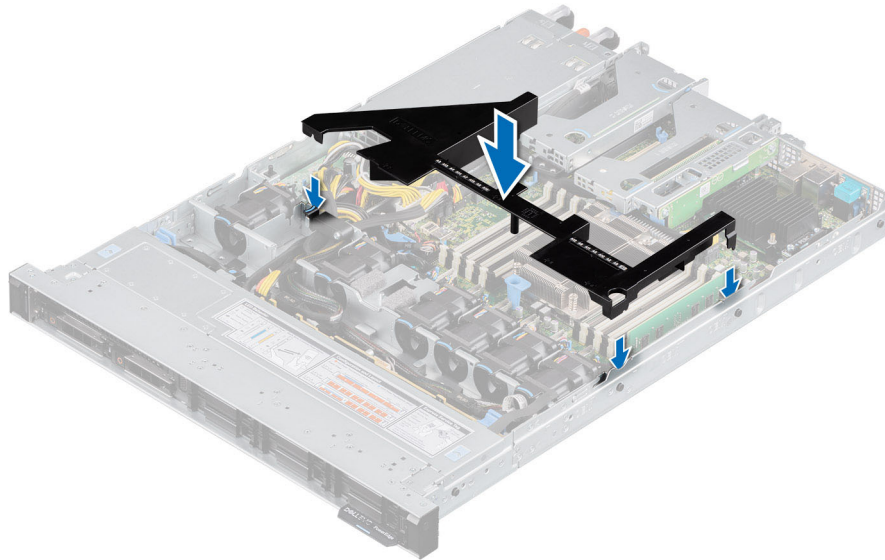

Figure 22. Installing the air shroud

Next steps

Follow the procedure listed in [After working inside your system](#).

Cooling fan

Removing a cooling fan

Prerequisites

1. Follow the safety guidelines listed in the [Safety instructions](#).
2. Follow the procedure listed in the [Before working inside your system](#).
3. [Remove the air shroud](#).
4. Move the cables out of way to access the fan cable connector on the system board.

NOTE: Observe the fan cable routing or make a note on the fan cable routing.

Steps

1. Disconnect the cooling fan cable connected to the system board connector.
2. Holding the blue tab, lift the cooling fan out of the fan cage.

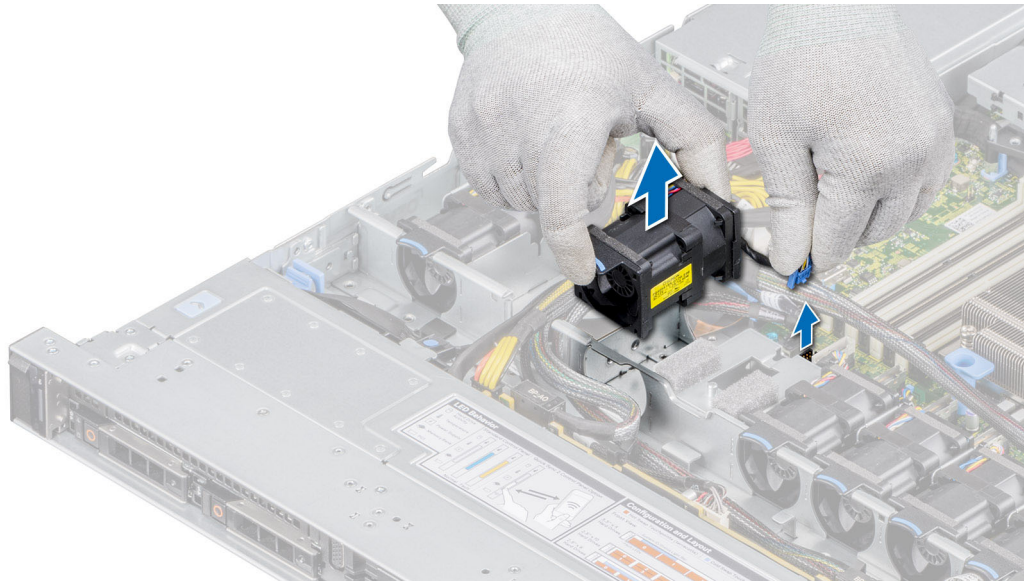

Figure 23. Removing a cooling fan

Next steps

[Replace a fan.](#)

Installing a cooling fan

Prerequisites

1. Follow the safety guidelines listed in the [Safety instructions](#).
2. Follow the procedure listed in the [Before working inside your system](#).

Steps

1. Lower the cooling fan into the cage until it is seated firmly.
2. Route the cable properly to prevent the cable from being pinched or crimped.
3. Press the release tabs on the fan cable connector and connect the cable to the system board.

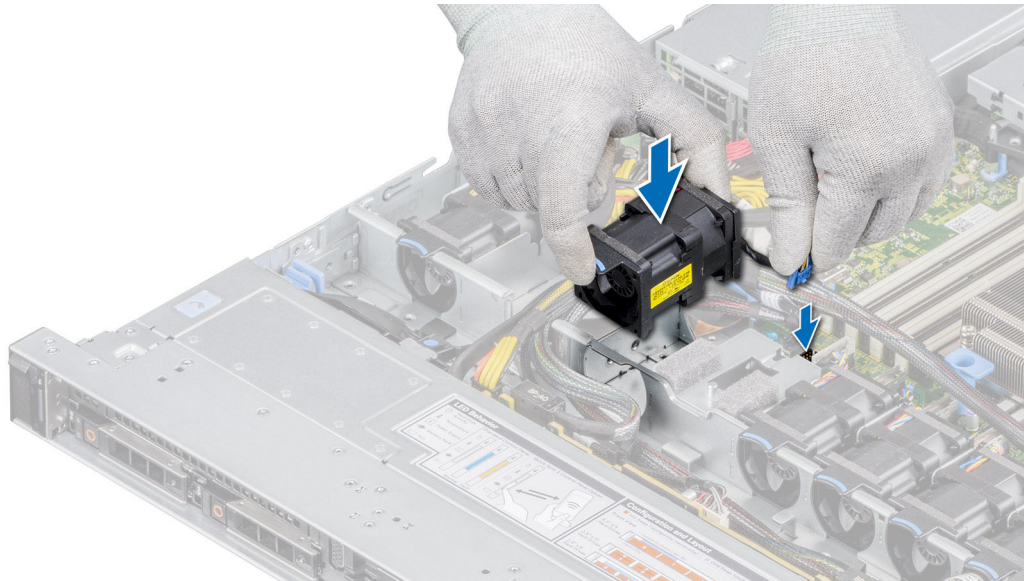

Figure 24. Installing a cooling fan

Next steps

1. [Install the air shroud.](#)
2. Follow the procedure listed in [After working inside your system.](#)

Intrusion switch module

Removing the intrusion switch

Prerequisites

1. Follow the safety guidelines listed in the [Safety instructions.](#)
2. Follow the procedure listed in the [Before working inside your system.](#)
3. [Remove the air shroud.](#)
4. Keep the plastic scribe ready.

Steps

1. Disconnect and remove the intrusion switch cable from the connector on the system board.
Observe the routing of the cable as you remove it from the system.
2. Using a plastic scribe, slide the intrusion switch out of the intrusion switch slot.

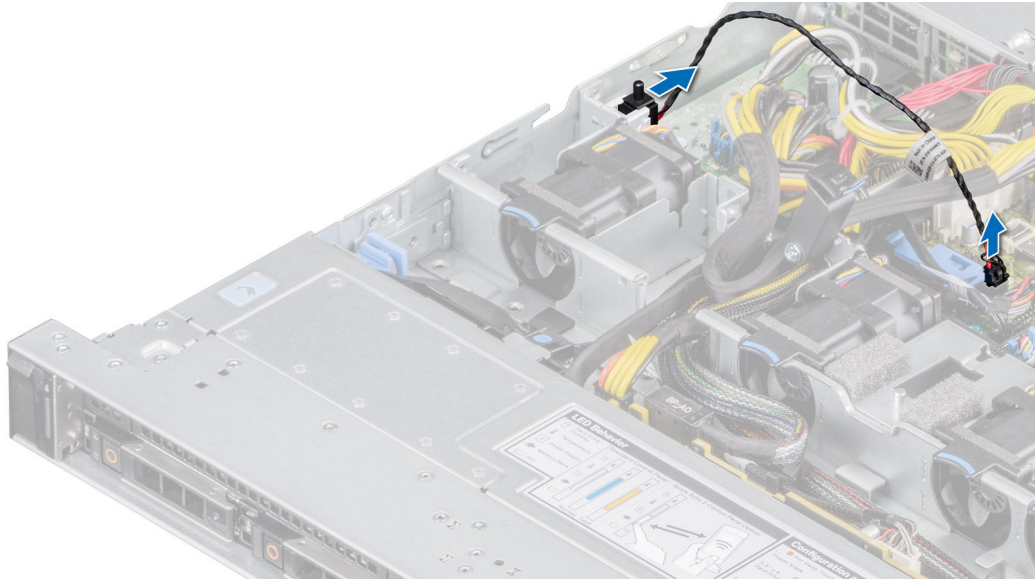

Figure 25. Removing the intrusion switch

Next steps

Replace the intrusion switch.

Installing the intrusion switch

Prerequisites

1. Follow the safety guidelines listed in the [Safety instructions](#).
2. Follow the procedure listed in the [Before working inside your system](#).

Steps

1. Align and slide the intrusion switch in the slot until it is firmly seated in the slot on the system.

NOTE: Route the cable properly when you replace it to prevent the cable from being pinched or crimped.

2. Connect the intrusion switch cable to the connector on the system board.

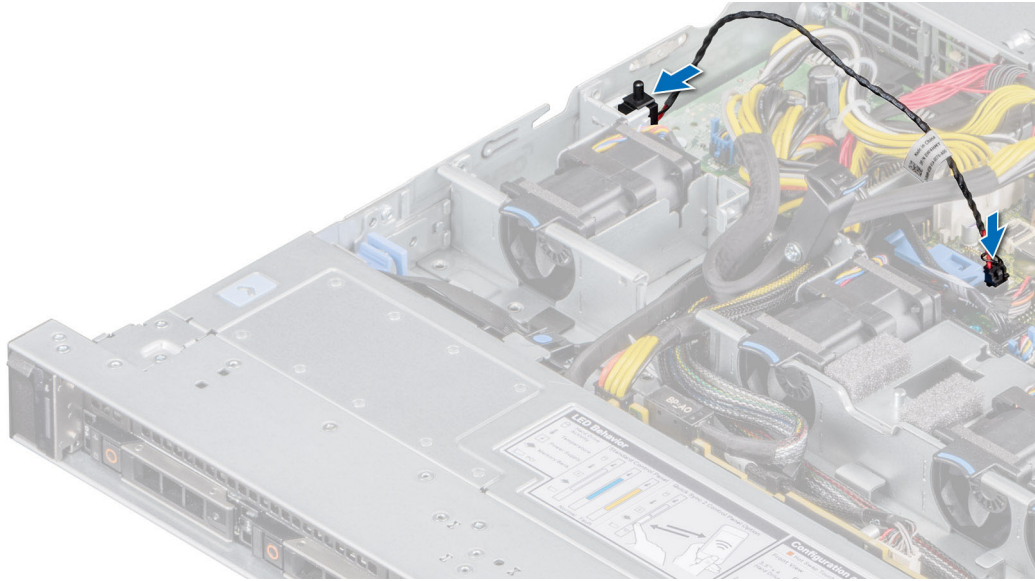

Figure 26. Installing the intrusion switch

Next steps

1. [Install the air shroud.](#)
2. Follow the procedure listed in [After working inside your system.](#)

Drives

Removing a drive blank

Prerequisites

1. Follow the safety guidelines listed in the [Safety instructions.](#)
2. If installed, [remove the front bezel.](#)

CAUTION: To maintain proper system cooling, drive blanks must be installed in all empty drive slots.

Steps

Press the release button, and slide the drive blank out of the drive slot.

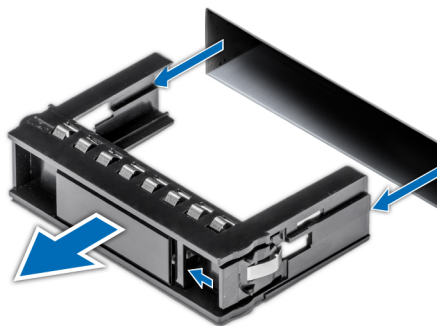

Figure 27. Removing a drive blank

Next steps

Installing a drive or replace the drive blank.

Installing a drive blank

Prerequisites

1. Follow the safety guidelines listed in the [Safety instructions](#).
2. If installed, [remove the front bezel](#).

Steps

Insert the drive blank into the drive slot until the release button clicks into place.

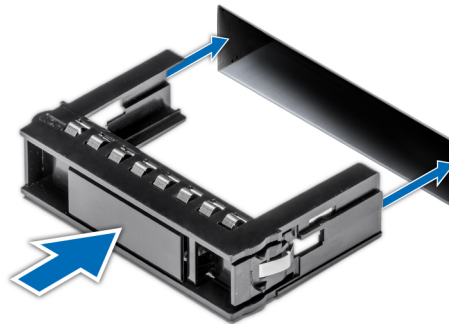

Figure 28. Installing a drive blank

Next steps

If removed, [install the front bezel](#).

Removing the drive carrier

Prerequisites

1. Follow the safety guidelines listed in the [Safety instructions](#).
2. If installed, [remove the front bezel](#).
3. Using the management software, prepare the drive for removal.

If the drive is online, the green activity or fault indicator blinks while the drive is powering off. When the drive indicators are off, the drive is ready for removal. For more information, see the documentation for the storage controller.

CAUTION: Before attempting to remove or install a drive while the system is running, see the documentation for the storage controller card to ensure that the host adapter is configured correctly to support drive removal and insertion.

CAUTION: To prevent data loss, ensure that your operating system supports drive installation. See the documentation supplied with your operating system.

Steps

1. Press the release button to open the drive carrier release handle.
2. Holding the drive carrier release handle, slide the drive carrier out of the drive slot.



Figure 29. Removing a drive carrier

Next steps

Install a [drive carrier](#) or [drive blank](#).

Installing the drive carrier

Prerequisites

- CAUTION:** Before removing or installing a drive while the system is running, see the documentation for the storage controller card to ensure that the host adapter is configured correctly to support drive removal and insertion.
- CAUTION:** Combining SAS and SATA drives in the same RAID volume is not supported.
- CAUTION:** When installing a drive, ensure that the adjacent drives are fully installed. Inserting a drive carrier and attempting to lock its handle next to a partially installed carrier can damage the partially installed carrier's shield spring and make it unusable.
- CAUTION:** To prevent data loss, ensure that your operating system supports hot-swap drive installation. See the documentation supplied with your operating system.
- CAUTION:** When a replacement hot swappable drive is installed and the system is powered on, the drive automatically begins to rebuild. Ensure that the replacement drive is blank or contains data that you wish to overwrite. Any data on the replacement drive is immediately lost after the drive is installed.

NOTE: Ensure that the drive carrier's release handle is in the open position before inserting the carrier into the slot.

1. Follow the safety guidelines listed in the [Safety instructions](#).
2. If installed, [remove the front bezel](#).
3. Remove the drive carrier or remove the drive blank when you want to assemble the drives in to the system.

Steps

1. Slide the drive carrier into the drive slot.
2. Close the drive carrier release handle to lock the drive in place.



Figure 30. Installing a drive carrier

Next steps

If removed, [install the front bezel](#).

Removing the drive from the drive carrier

Prerequisites

1. Follow the safety guidelines listed in the [Safety instructions](#).
2. If installed, [remove the front bezel](#).

Steps

1. Using a Phillips #1 screwdriver, remove the screws from the slide rails on the drive carrier.

NOTE: If the hard drive or SSD carrier has Torx screw, use Torx 6 (for 2.5-inch drive) or Torx 8 (for 3.5-inch drive) screwdriver to remove the drive. 

2. Lift the drive out of the drive carrier.



Figure 31. Removing the drive from the drive carrier

Next steps

Install the drive into the drive carrier.

Installing the drive into the drive carrier

Prerequisites

1. Follow the safety guidelines listed in the [Safety instructions](#).
2. If installed, [remove the front bezel](#).
3. Remove the drive blank.

i **NOTE:** When installing a drive into the drive carrier, ensure that the screws are torqued to 4 in-lbs.

Steps

1. Insert the drive into the drive carrier with the drive connector facing towards the rear of the carrier.
2. Align the screw holes on the drive with the screws holes on the drive carrier.
3. Using a Phillips #1 screwdriver, secure the drive to the drive carrier with the screws.

i **NOTE:** If the hard drive or SSD carrier has Torx screw, use Torx 6 (for 2.5-inch drive) or Torx 8 (for 3.5-inch drive) screwdriver to install the drive. 

i **NOTE:** When installing a drive into the drive carrier, ensure that the screws are torqued to 4 in-pounds.



Figure 32. Installing a drive into the drive carrier

Next steps

1. Install the drive carrier.
2. If removed, install the front bezel.

Drive backplane

Drive backplane

Depending on your system configuration, the drive backplanes supported are listed here:

Table 11. Supported backplane options

System	Supported hard drives options
PowerEdge R6515	3.5 inch (x4) SAS, SATA backplane
	2.5 inch (x8) SAS or SATA backplane
	2.5 inch (x10) SAS, SATA or NVMe backplane

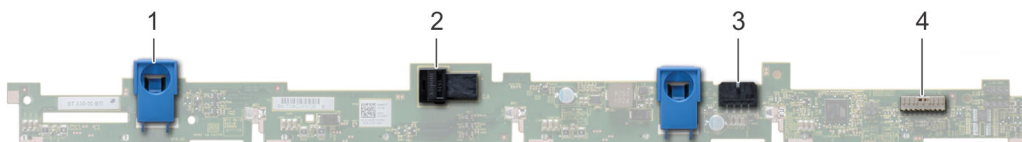

Figure 33. 4 x 3.5-drive backplane

1. release tab
2. SAS_A connector on the backplane
3. backplane power cable

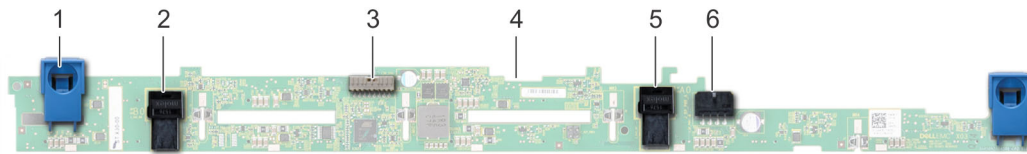

Figure 34. 8 x 2.5-drive backplane

- | | |
|---------------------------|---------------------------|
| 1. release tab | 2. SATA_A cable connector |
| 3. backplane signal cable | 4. backplane |
| 5. SATA_B cable connector | 6. backplane power cable |



Figure 35. 10 x 2.5-SAS, SATA or NVMe drive backplane

- | | |
|------------------------------|-----------------------------|
| 1. BO NVMe cable connector | 2. I2C cable connector |
| 3. A0 NVMe cable connector | 4. SAS/SATA cable connector |
| 5. B1 NVMe cable connector | 6. A1 NVMe cable connector |
| 7. SAS/SATA cable connector | 8. A2 NVMe cable connector |
| 9. backplane power connector | |

Removing the backplane

Prerequisites

CAUTION: To prevent damage to the drives and backplane, remove the drives from the system before removing the backplane.

CAUTION: Note the number of each drive and temporarily label them before you remove the drive so that you can reinstall them in the same location.

NOTE: The procedure to remove the backplane is similar for all backplane configurations.

1. Follow the safety guidelines listed in the [Safety instructions](#).
2. Follow the procedure listed in the [Before working inside your system](#).
3. [Remove the air shroud](#).
4. Remove the backplane cover.
5. Remove all the drives.
6. Disconnect the VGA cable from the system board.

NOTE: Observe the routing of the cable as you remove it from the system.

7. If installed, disconnect the optical drive signal and power cables from the drive.

Steps

1. Press the blue release tabs to disengage the drive backplane from the hooks on the system.
2. Lift the drive backplane out of the system.

NOTE: To avoid damaging the backplane, ensure that you move the control panel cables from the cable routing clips before removing the backplane.

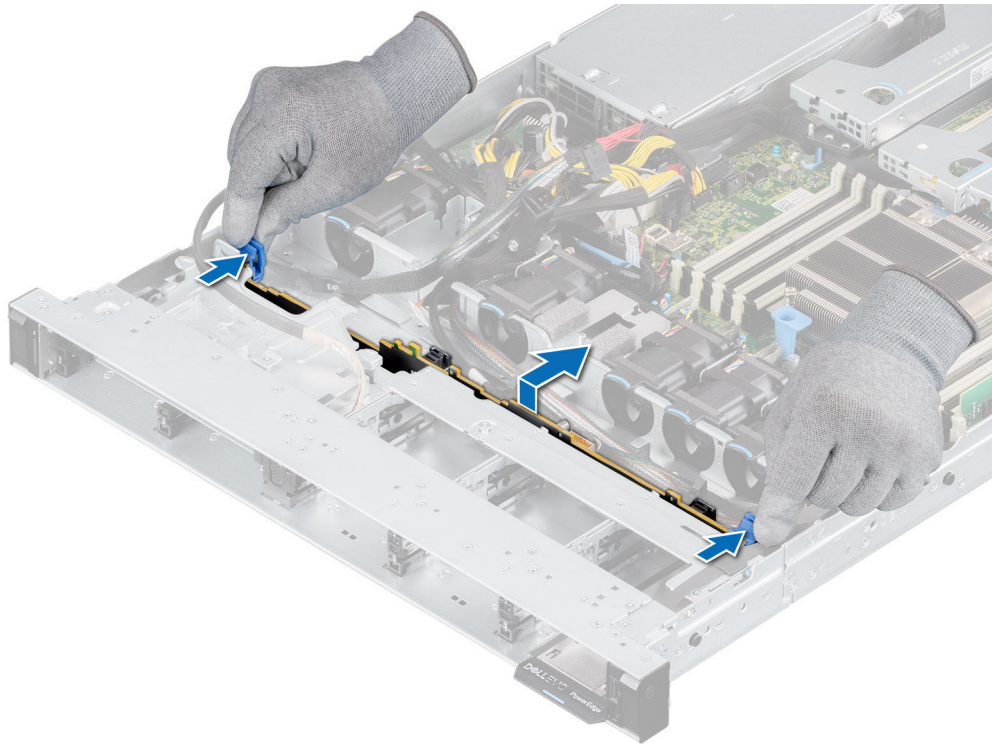

Figure 36. Removing the backplane

Next steps

Replace the drive backplane.

Installing the drive backplane

Prerequisites

1. Follow the safety guidelines listed in the [Safety instructions](#).
2. Follow the procedure listed in the [Before working inside your system](#).
3. [Remove the air shroud](#).
4. Remove the backplane cover.
5. Remove all the drives.
 - i** **NOTE:** To avoid damaging the backplane, ensure to move the control panel cables from the cable routing clips before removing the backplane.
 - i** **NOTE:** Route the cable properly when you replace it to prevent the cable from being pinched or crimped.

Steps

1. Use the hooks on the system as guides to align the slots on the backplane with the guides on the system.
2. Insert the backplane into the guides and lower the backplane until the blue release tabs click into place.

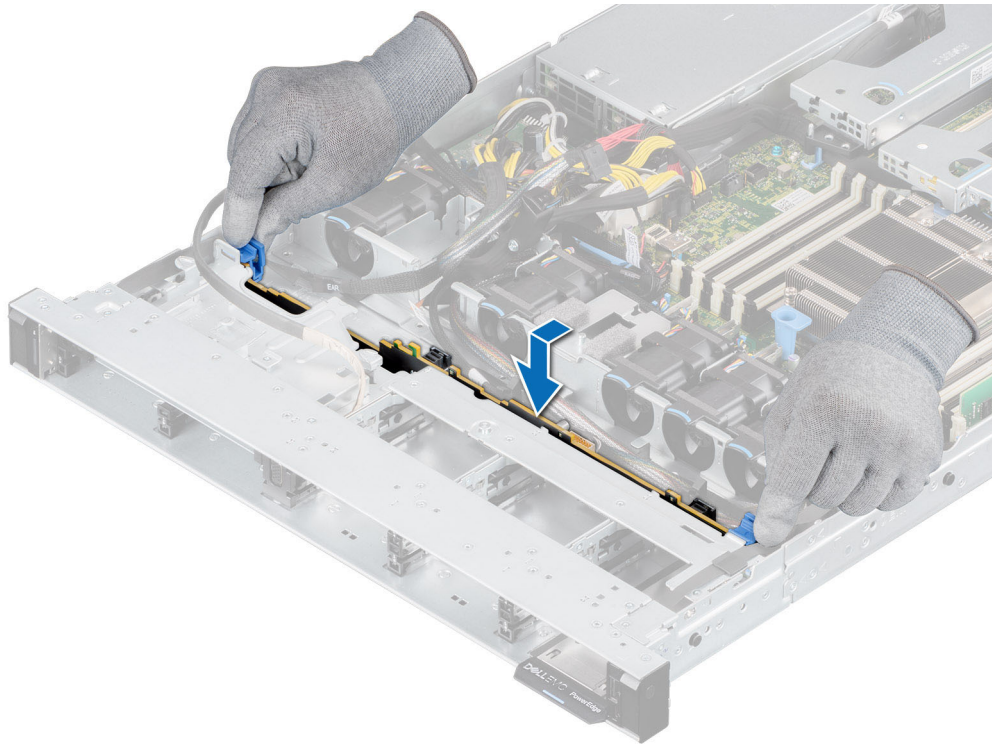

Figure 37. Installing the drive backplane

Next steps

1. Reconnect the VGA cable to the system board.
2. If disconnected, reconnect the optical drive power and signal cables to the drive.
3. Reconnect all the disconnected cables to the backplane.
4. Install all the drives.
5. Install the backplane cover.
6. [Install the air shroud.](#)
7. Follow the procedure listed in [After working inside your system.](#)

Cable routing

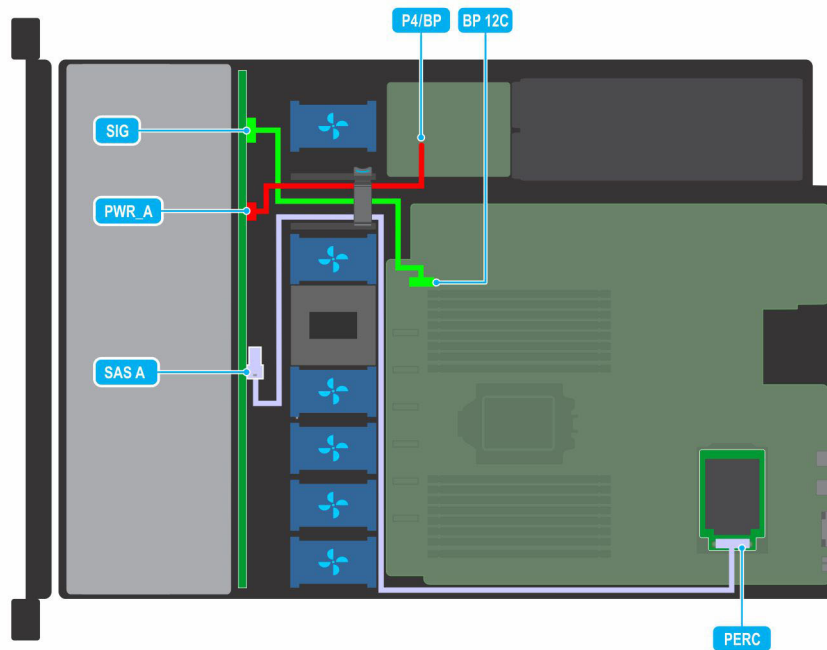

Figure 38. Cable routing - 4 x 3.5-inch drive backplane to the mini-PERC card

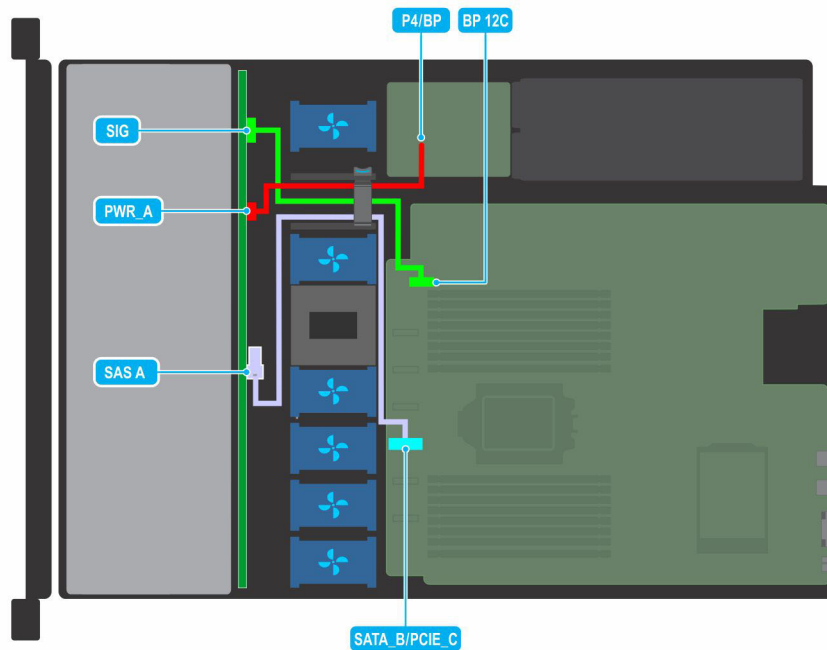

Figure 39. Cable routing - 4 x 3.5-inch drive backplane to the onboard controller

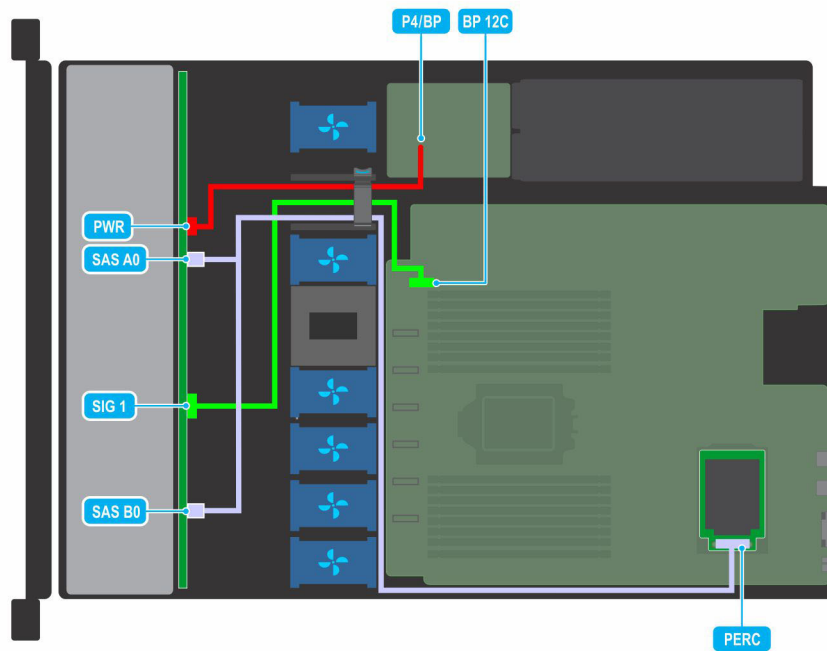

Figure 40. Cable routing - 8 x 2.5-inch drive backplane to the mini-PERC card

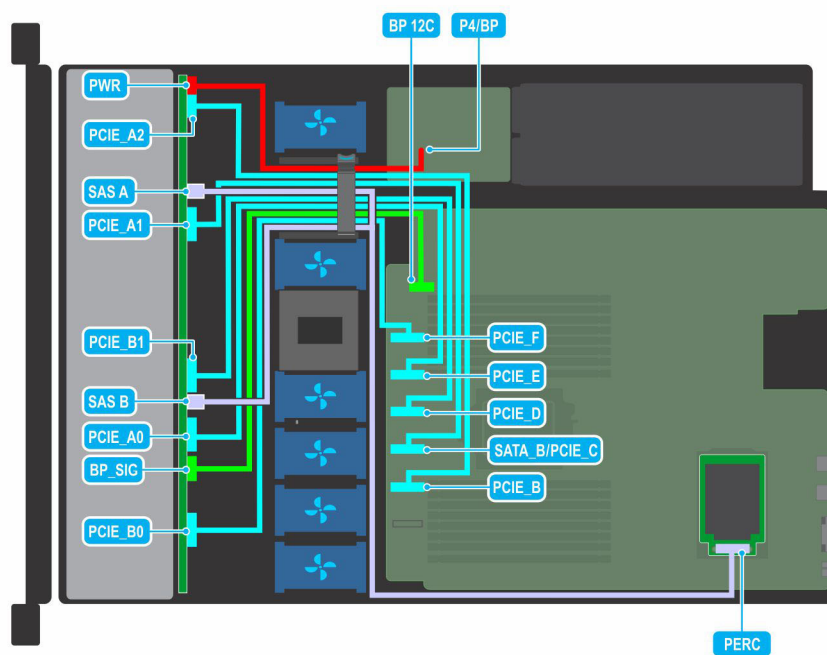

Figure 41. Cable routing - 10 x 2.5-inch drive backplane to the onboard controller (NVMe)

System memory

System memory guidelines

The PowerEdge R6515 system supports DDR4 registered DIMMs (RDIMMs) and load reduced DIMMs (LRDIMMs). System memory holds the instructions that are executed by the processor.

Your system memory is organized into eight channels per processor (two memory sockets per channel) for a total of 16 memory sockets per processor. In each channel, the 1st socket is marked white and the 2nd socket black.

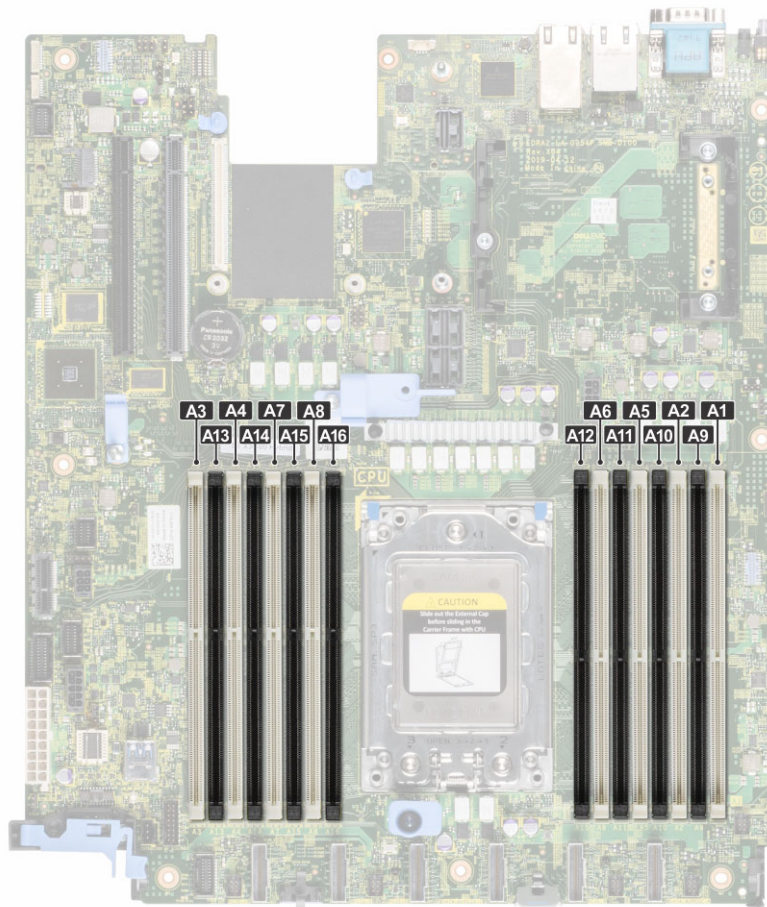

Figure 42. Memory socket location

Memory channels are organized as follows:

Table 12. Memory channels

Processor	Channel A	Channel B	Channel C	Channel D	Channel E	Channel F	Channel G	Channel H
AMD Processor	Slots 6 and 12	Slots 5 and 11	Slots 2 and 10	Slots 1 and 9	Slots 8 and 16	Slots 7 and 15	Slots 4 and 14	Slots 3 and 13

Table 13. Supported memory matrix

DIMM type	Rank type	Capacity	DIMM rated voltage and speed	Operating Speed	
				1 DIMMs per Channel (DPC)	2 DIMMs per Channel (DPC)
RDIMM	1R	8 GB	DDR4 (1.2V), 3200 MT/s	3200 MT/s	2933 MT/s
	2R	16 GB, 32 GB, 64 GB	DDR4 (1.2V), 3200 MT/s	3200 MT/s	2933 MT/s
LRDIMM	8R	128 GB	DDR4 (1.2V), 2666 MT/s	2666 MT/s	2666 MT/s
	8R	128 GB	DDR4 (1.2V), 3200 MT/s	3200 MT/s	2933 MT/s

NOTE: The older 32 GB capacity RDIMM memory with x4 data width and 8Gb DRAM density cannot be mixed with the newer 32 GB capacity RDIMM memory with x8 data width and 16Gb DRAM density in the same AMD EPYC™ processor unit.

NOTE: The older 128 GB capacity LRDIMM memory at 2666 MT/s speed cannot be mixed with the new 128 GB capacity LRDIMM memory at 3200 MT/s speed.

General memory module installation guidelines

To ensure optimal performance of your system, observe the following general guidelines when configuring your system memory. If your system's memory configurations fail to observe these guidelines, your system might not boot, stop responding during memory configuration, or operate with reduced memory. This section provides information on the memory population rules and about the non-uniform memory access (NUMA) for single or dual processor system.

The memory bus may operate at speeds of 3200 MT/s, 2933 MT/s, or 2666 MT/s depending on the following factors:

- System profile selected (for example, Performance Optimized, or Custom [can be run at high speed or lower])
- Maximum supported DIMM speed of the processors
- Maximum supported speed of the DIMMs

NOTE: MT/s indicates DIMM speed in MegaTransfers per second.

The system supports Flexible Memory Configuration, enabling the system to be configured and run in any valid chipset architectural configuration. The following are the recommended guidelines for installing memory modules:

- All DIMMs must be DDR4.
- Mixing of memory module capacities in a system is not supported.
- If memory modules with different speeds are installed, they operate at the speed of the slowest installed memory module(s).
- Populate memory module sockets only if a processor is installed.
 - For single-processor systems, sockets A1 to A16 are available.
 - In Optimizer Mode, the DRAM controllers operate independently in the 64-bit mode and provide optimized memory performance.

Table 14. Memory population rules

Processor	Configuration	Memory population	Memory population information
Single processor	Optimizer (Independent channel) population order	A{1}, A{2}, A{3}, A{4}, A{5}, A{6}, A{7}, A{8}, A{9}, A{10}, A{11}, A{12}, A{13}, A{14}, A{15}, A{16}	Odd amount of DIMMs per processor allowed.

- Populate all the sockets with white release tabs first, followed by the black release tabs.
- Unbalanced or odd memory configuration results in a performance loss and system may not identify the memory modules being installed, so always populate memory channels identically with equal DIMMs for best performance.
- Minimum recommended configuration is to populate four equal memory modules per processor. AMD recommends limiting processors in that system to 32 cores or less.
- Populate eight equal memory modules per processor (one DIMM per channel) at a time to maximize performance.

NOTE: Equal memory modules refer to DIMMs with identical electrical specification and capacity that may be from different vendors.

Memory interleaving with Non-uniform memory access (NUMA)

Non-uniform memory access (NUMA) is a memory design used in multi-processing, where the memory access time depends on the memory location relative to the processor. In NUMA, a processor can access its own local memory faster than the non-local memory.

NUMA nodes per socket (NPS) is a new feature added that allows you to configure the memory NUMA domains per socket. The configuration can consist of one whole domain (NPS1), two domains (NPS2), or four domains (NPS4). In the case of a two-socket platform, an additional NPS profile is available to have whole system memory to be mapped as single NUMA domain (NPS0). For more information on the memory interleaving for NPSx, see the Memory interleaving population rules section in this topic.

BIOS implementation for NPSx

- The BIOS Setup menu presents the applicable NPSx options based on the underlying model number. A change to the current NPSx is communicated to pre-BIOS firmware to take effect on the next boot. The default NPS setting is 1.

- During boot, if the selected NPSx option is not allowed for the model number (for example, if the processor model number changes between reboot), system will halt at the end of POST with UEFI0388 message displayed. On the next reboot, the system will fall back to NPS1 default setting.
- During boot, if the preferred interleaving for the current NPSx is not possible due to memory configuration (for example, the memory population is inconsistent with the preferred interleaving), BIOS shows a warning message UEFI0391.

i **NOTE:** System is functional when UEFI0391 message is displayed. However, the system may not be configured for optimal performance.

NPS system optimization

Optimal system configuration is dependent on the processor model, memory configuration, and NPS settings. Match the memory configuration with the NPS settings available for the processor.

Table 15. Supported NPS modes by Processors

Model Number	NPS modes supported
7773X	4, 2, 1, 0
7573X	4, 2, 1, 0
75F3	4, 2, 1, 0
7713P	4, 2, 1
7663	4, 2, 1, 0
7513	4, 2, 1, 0
7543P	4, 2, 1
74F3	4, 2, 1, 0
7443	4, 2, 1, 0
7443P	4, 2, 1
73F3	4, 2, 1, 0
7313P	4, 2, 1
7643	4, 2, 1, 0
72F3	4, 2, 1, 0
7742	4, 2, 1, 0
7702	4, 2, 1, 0
7702P	4, 2, 1
7662	4, 2, 1, 0
7642	4, 2, 1, 0
7552	2, 1, 0
7542	4, 2, 1, 0
7532	4, 2, 1, 0
7502	4, 2, 1, 0
7502P	4, 2, 1
7452	4, 2, 1, 0
7402	4, 2, 1, 0
7402P	4, 2, 1
7352	4, 2, 1, 0
7302	4, 2, 1, 0
7302P	4, 2, 1

Table 15. Supported NPS modes by Processors (continued)

Model Number	NPS modes supported
7282	1, 0
7272	1, 0
7262	4, 2, 1, 0
7252	1, 0
7232P	1
7F72	2, 1, 0
7F52	4, 2, 1, 0
7F32	4, 2, 1, 0
7H12	4, 2, 1, 0
7763	4, 2, 1, 0
7413	4, 2, 1, 0
75F3	4, 2, 1, 0
7713P	4, 2, 1
7513	4, 2, 1, 0
7543P	4, 2, 1
7443P	4, 2, 1
7313P	4, 2, 1

Table 16. Optimal NPS configuration

Number of DIMMs per processor	NPS			
	0	1	2	4
1				X
2				X
3				X
4		X		
5				X
6				X
7				X
8	X	X		
9				X
10				X
11				X
12			X	
13				X
14				X
15				X
16	X	X		

- Recommended NPS setting is marked by X that indicate optimal performance.

- NPS0 is only available for dual processor systems and is the preferred setting.
- The NPS setting that are blank are functional. However, indicate non-optimal performance.
- BIOS default NPS setting is 1.
- UEFI0391 message may be displayed during boot if DIMMs are configured in the blank spaces of the table.
- If the processor does not support the desired NPS setting for a given number of DIMMs, then use default setting (NPS1) and the UEFI0391 message is displayed.

Memory interleaving population rules

- NPS4: Two channel interleaving
 - This interleaves channel [A and B], [C and D], etc.
 - Each channel within the pair requires at least one equal memory modules populated.
 - Works with three memory modules per channel pair, non-symmetrical module is stacked on top (odd configurations).
 - Any memory channel where one of the two channels is not populated is not interleaved.
 - There is no alternate, as all configurations can be mapped into this mode.
- NPS2: Four channel interleaving
 - This interleaves the four channels on the left or right half of a processor which are channels [A, B, C, D] and [E, F, G, H].
 - All four channels require equal memory modules populated.
 - Each half or interleave set may have different total memory capacity with respect to each other.
- NPS1: Eight channel interleaving
 - This interleaves all channels in a processor [A, B, C, D, E, F, G, H].
 - All channels in a processor require equal memory modules populated.
 - Single processor system creates a single NUMA node for the system.

 **NOTE:** An exception is allowed when system has 4-channels populated [C, D, G, H] with equal memory allowing the system to enter NPS1 mode even though all the 8 channels are not populated.

Removing a memory module

Prerequisites

1. Follow the safety guidelines listed in the [Safety instructions](#).
2. Follow the procedure listed in the [Before working inside your system](#).
3. [Remove the air shroud](#).

 **WARNING:** The memory modules are hot to touch for some time after the system has been powered off. Allow the memory modules to cool before handling them.

Steps

1. Locate the appropriate memory module socket.
2. To release the memory module from the socket, simultaneously press the ejectors on both ends of the memory module socket to fully open.

 **CAUTION:** Handle each memory module only by the card edges, ensuring not to touch the middle of the memory module or metallic contacts.

3. Lift the memory module away from the system.

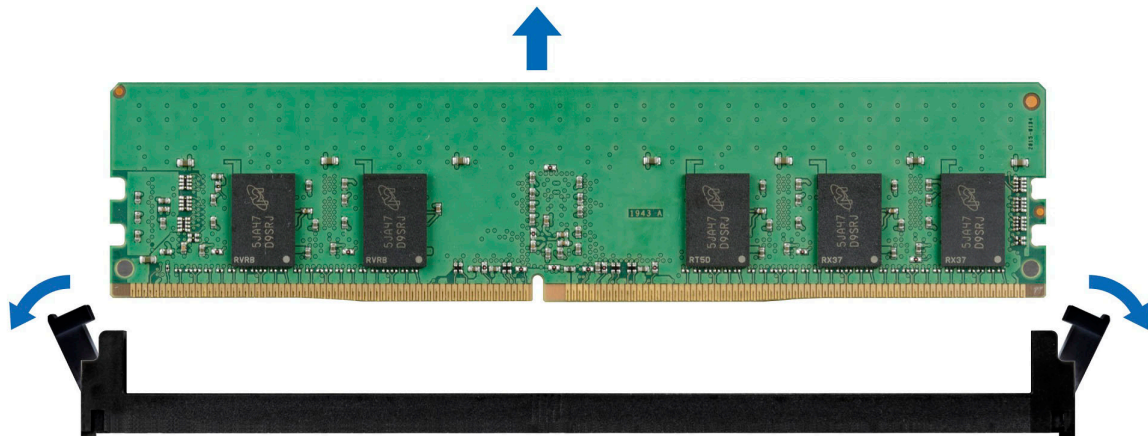

Figure 43. Removing a memory module

Next steps

Replace the memory module.

Installing a memory module

Prerequisites

1. Follow the safety guidelines listed in the [Safety instructions](#).
2. Follow the procedure listed in the [Before working inside your system](#).
3. [Remove the air shroud](#).

Steps

1. Locate the appropriate memory module socket.

CAUTION: Handle each memory module only by the card edges, ensuring not to touch the middle of the memory module or metallic contacts.

2. If a memory module is installed in the socket, remove it.

NOTE: Ensure the socket ejector latches are fully open, before installing the memory module.

3. Align the edge connector of the memory module with the alignment key of the memory module socket, and insert the memory module in the socket.

CAUTION: To prevent damage to the memory module or the memory module socket during installation, do not bend or flex the memory module; insert both ends of the memory module simultaneously.

NOTE: The memory module socket has an alignment key that enables you to install the memory module in the socket in only one orientation.

CAUTION: Do not apply pressure at the center of the memory module; apply pressure at both ends of the memory module evenly.

4. Press the memory module with your thumbs until the ejectors firmly click into place. When the memory module is properly seated in the socket, the levers on the memory module socket align with the levers on the other sockets that have memory modules installed.

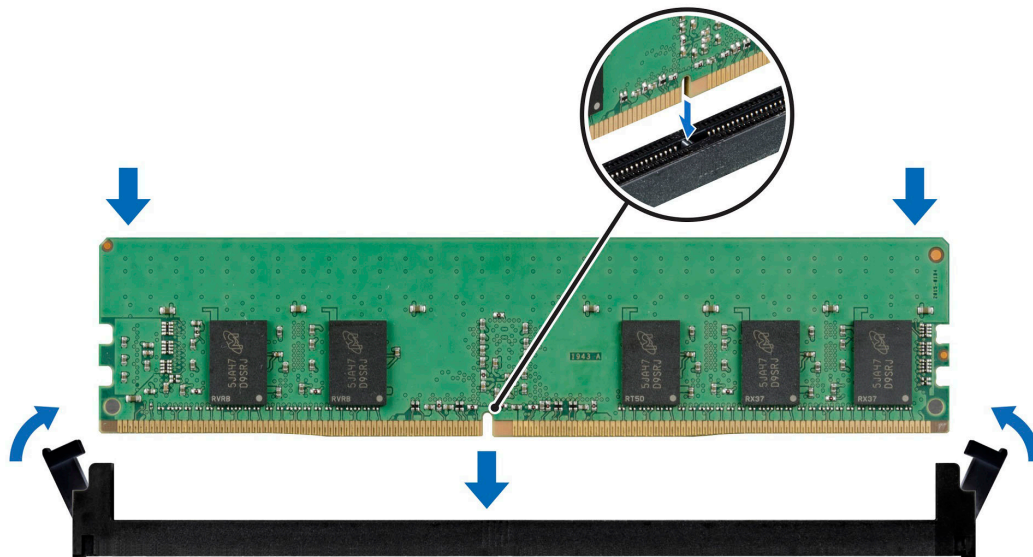

Figure 44. Installing a memory module

Next steps

1. [Install the air shroud.](#)
2. Follow the procedure listed in [After working inside your system.](#)
3. To verify if the memory module has been installed properly, press F2 and navigate to **System Setup Main Menu > System BIOS > Memory Settings**. In the **Memory Settings** screen, the System Memory Size must reflect the updated capacity of the installed memory.
4. If the System Memory Size is incorrect, one or more of the memory modules may not be installed properly. Ensure that the memory modules are firmly seated in their sockets.
5. Run the system memory test in system diagnostics.

Processor and heat sink

Removing a heat sink

Prerequisites

1. Follow the safety guidelines listed in the [Safety instructions](#).
2. Follow the procedure listed in the [Before working inside your system](#).
3. [Remove the air shroud.](#)

NOTE: The heat sink and processor are too hot to touch for some time after the system has been powered down. Allow the heat sink and processor to cool down before handling them.

Steps

1. Using a Torx #T20 screwdriver, loosen the captive screws in the order mentioned on the heat sink:

NOTE: The captive screw numbers are marked on the heat sink.

- a. Partially loosen the captive screws 1 and 2 (approximately 3 turns).
 - b. Partially loosen the captive screws 3 and 4 (approximately 3 turns).
 - c. Loosen the captive screws 1 and 2 completely.
 - d. Loosen the captive screws 3 and 4 completely.
2. Lift the heat sink from the system.

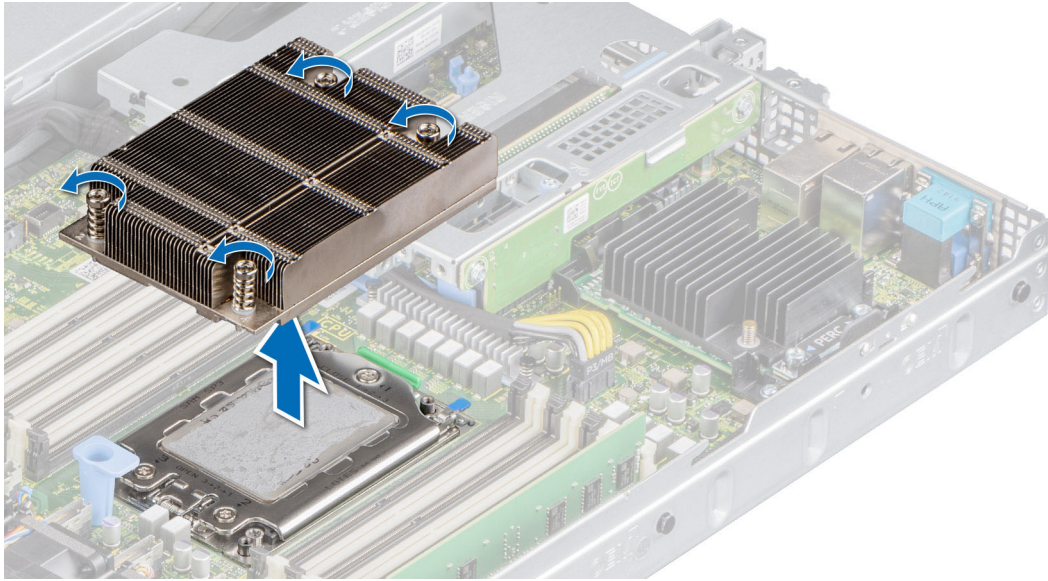

Figure 45. Removing a heat sink

Next steps

If you are removing a faulty heat sink, replace the heat sink, if not, remove the processor.

Removing the AMD processor

Prerequisites

⚠ WARNING: The heat sink may be hot to touch for some time after the system has been powered off. Allow the heat sink to cool before removing it.

1. Follow the safety guidelines listed in the [Safety instructions](#).
2. Follow the procedure listed in the [Before working inside your system](#).
3. [Remove the air shroud](#).
4. [Remove the heat sink](#).

⚠ CAUTION: You may find the CMOS battery loss or CMOS checksum error displayed during the first instance of powering on the system after the processor or system board replacement which is expected. To fix this, simply go to setup option to configure the system settings.

Steps

1. Using a Torx #T20 screwdriver, loosen the screws to release the force plate. The sequence to loosen the screws is 3, 2, and 1.

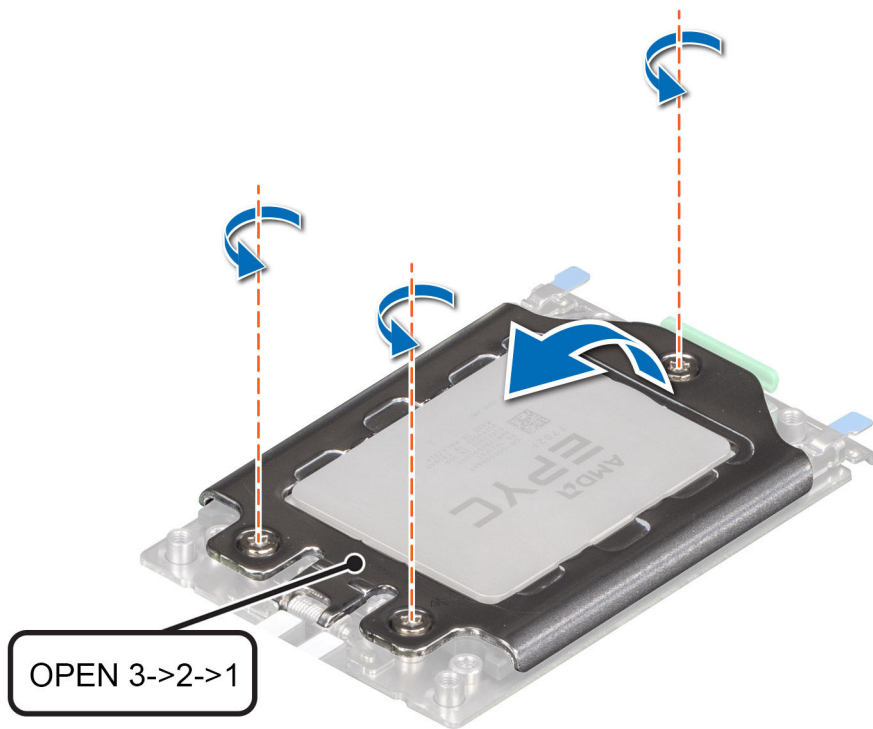

Figure 46. Removing screws on the force plate

2. Release the processor socket rail frame by lifting up the blue latches.

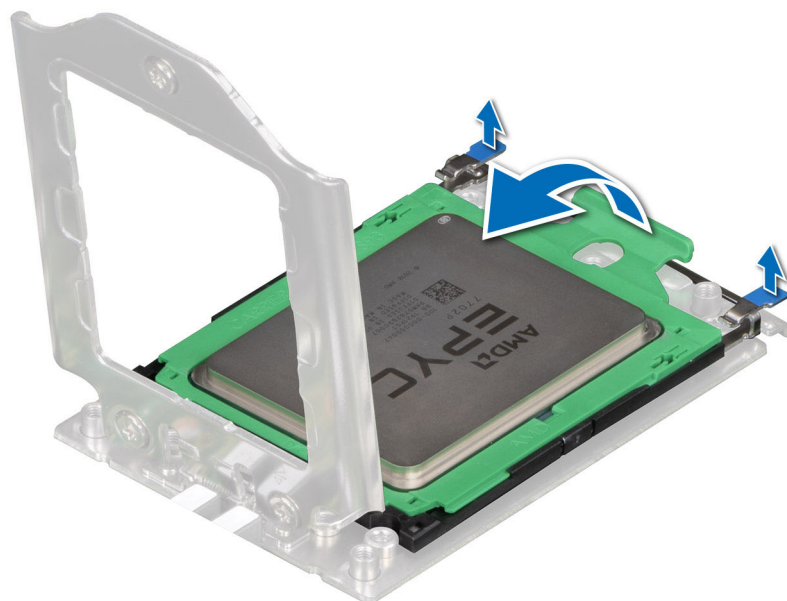

Figure 47. Lifting the rail frame

3. Holding the blue tab on the processor tray, slide the tray out of the rail frame.

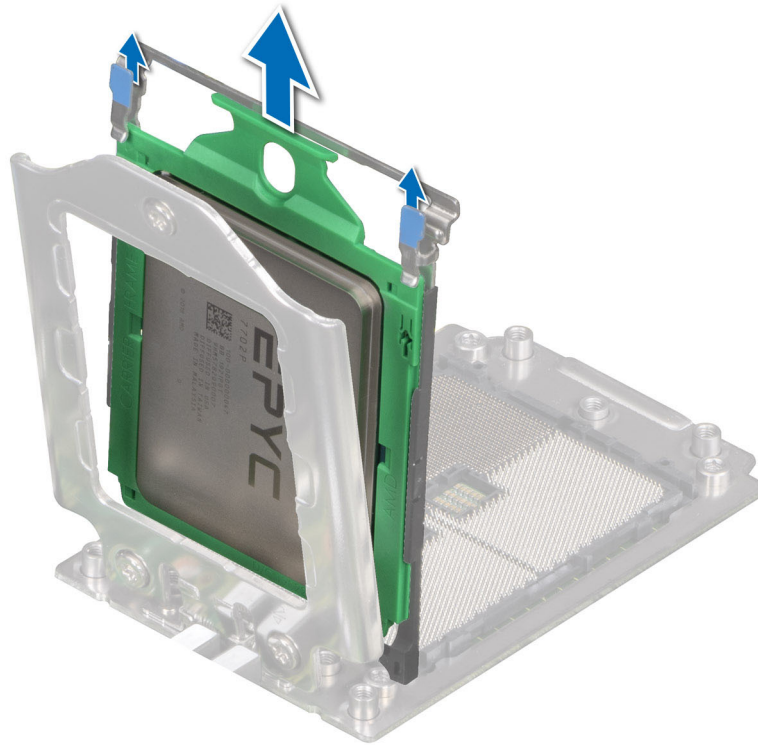

Figure 48. Removing the processor tray

Next steps

Replace the AMD processor.

Installing the AMD processor

Prerequisites

1. Follow the safety guidelines listed in the [Safety instructions](#).
2. Follow the procedure listed in [Before working inside your system](#).

Steps

1. Holding the blue tab on the processor tray, slide the tray into the processor socket rail frame until firmly seated.

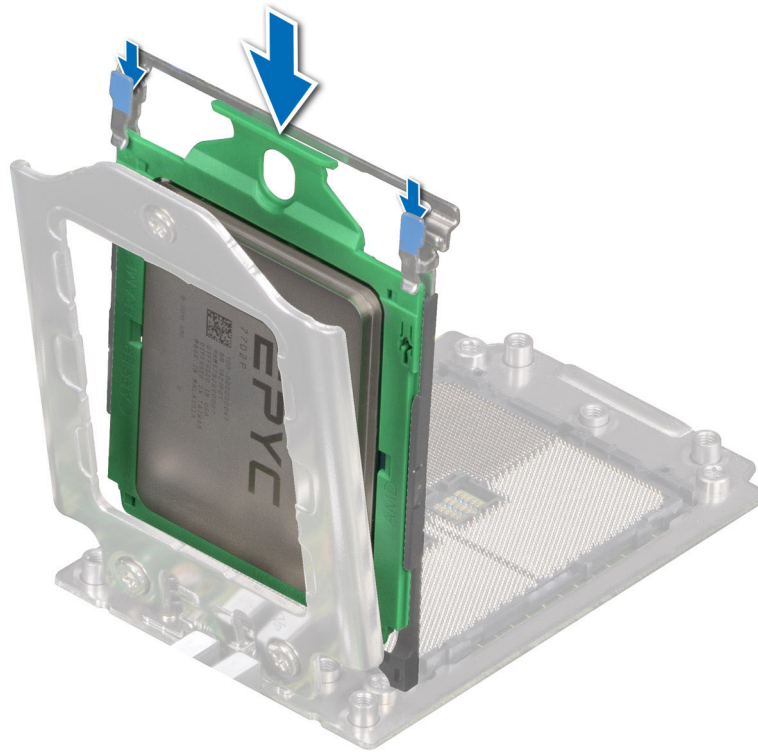

Figure 49. Placing the processor tray into the rail frame

2. Push the rail frame down until the blue latches lock into place.

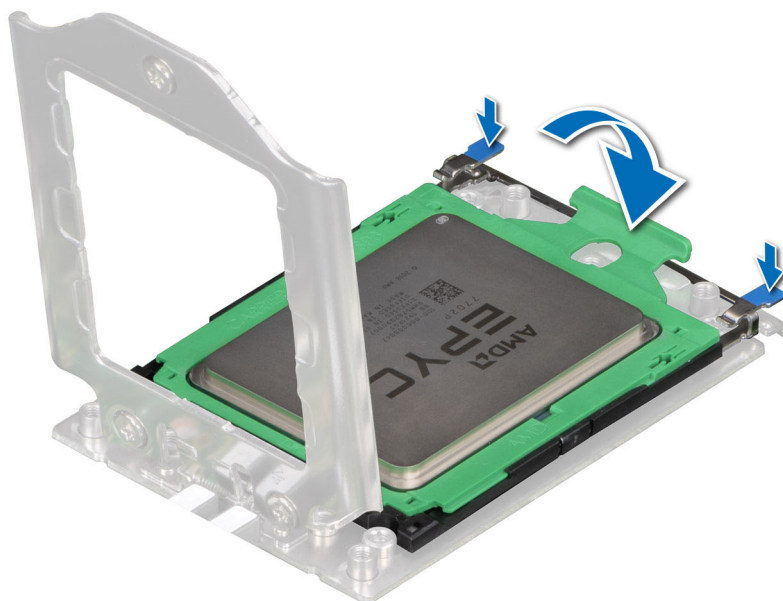

Figure 50. Closing the rail frame

3. Secure the force plate to the processor socket base by tightening the screws in the sequence 1, 2, and 3. When all three screws are fully threaded, the socket is then actuated. The three screws are tightened to a torque value of 12.0 ± 1.0 lbf-in.

NOTE: Press the force plate while tightening the screws to avoid tilting of the processor cover out of the processor socket.

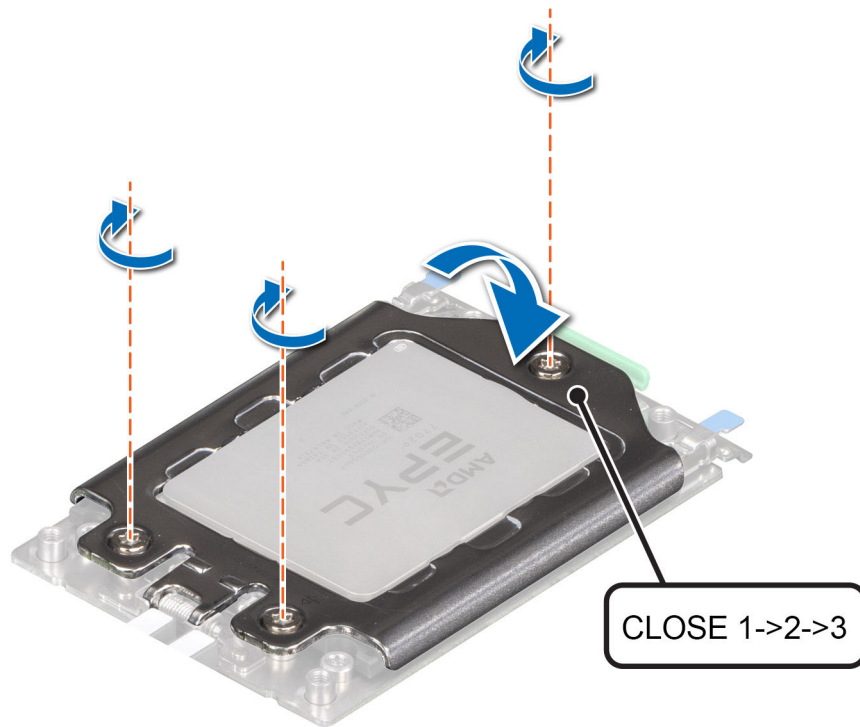

Figure 51. Securing the force plate

Next steps

1. [Install the heat sink.](#)
2. [Install the air shroud.](#)
3. Follow the procedure listed in [After working inside your system.](#)

Installing the heat sink

Prerequisites

Never remove the heat sink from a processor unless you intend to replace the processor or system board. The heat sink is necessary to maintain proper thermal conditions.

1. Follow the safety guidelines listed in the [Safety instructions.](#)
2. Follow the procedure listed in the [Before working inside your system.](#)
3. [Remove the air shroud.](#)
4. If installed, remove the processor dust cover.

Steps

1. If you are using an existing heat sink, remove the thermal grease on the heat sink by using a clean lint-free cloth.

NOTE: For a new heat sink, the thermal paste is pre-applied to the heat sink. Remove the protective cover and install the heat sink.

2. Use the thermal grease syringe included with your processor kit to apply the grease in a thin spiral on the top of the processor.

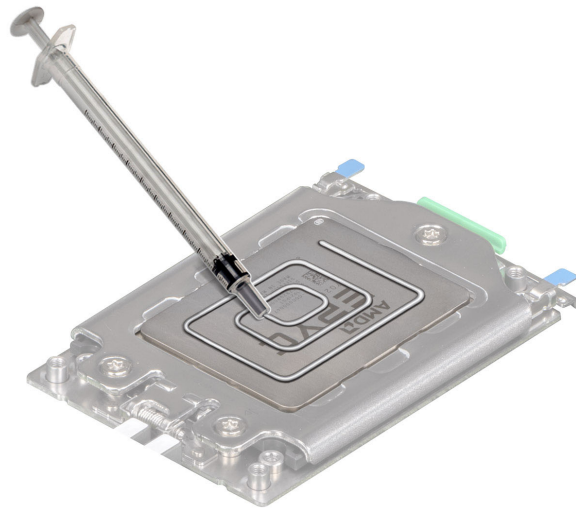

Figure 52. Installing the heat sink

CAUTION: Applying too much thermal grease can result in excess grease coming in contact with and contaminating the processor socket.

NOTE: The thermal grease syringe is intended for single use only. Dispose of the syringe after you use it.

3. Align the heat sink with the screw holes on the processor plate. The captive screws on the heat sink should align with the screw holes on the processor plate.
4. Using a Torx #T20 screwdriver, tighten the captive screws in the order mentioned below:

NOTE: The captive screw numbers are marked on the heat sink.

- a. Partially tighten the captive screws 1 and 2 (approximately 3 turns).
- b. Partially tighten the captive screws 3 and 4 (approximately 3 turns).
- c. Tighten the captive screws 1 and 2 completely.
- d. Tighten the captive screws 3 and 4 completely.

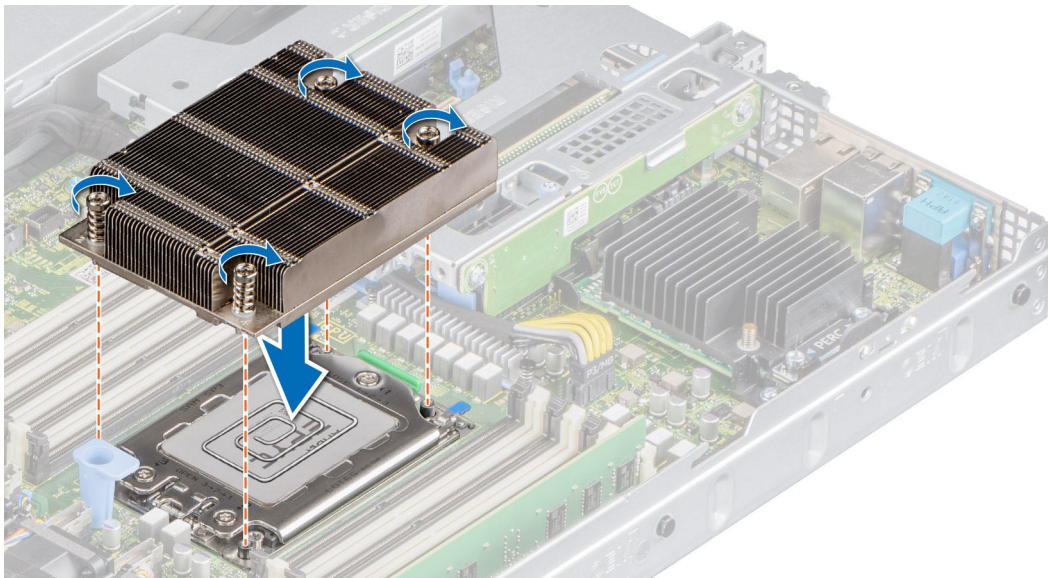

Figure 53. Installing the heat sink

Next steps

1. Install the air shroud.

2. Follow the procedure listed in the [After working inside your system](#).

Expansion cards and expansion card risers

NOTE: A system event entry is logged in the iDRAC Lifecycle Controller if an expansion card riser is not supported or missing. It does not prevent your system from turning on. However, if a F1/F2 pause occurs with an error message, see *Troubleshooting expansion cards* section in the *Dell EMC PowerEdge Servers Troubleshooting Guide* at www.dell.com/poweredgemanuals.

Expansion card installation guidelines

The following table describes the supported expansion cards:

Table 17. Expansion card riser configurations

Expansion card riser	PCIe slots on the riser	Processor connection	Height	Length	Slot width
No riser	Slot 1	Processor 1	NA	NA	x8
Riser 1A	Slot 2	Processor 1	Low Profile	Half Length	x16
Riser 2	Slot 3	Processor 1	Low Profile	Half Length	x16

NOTE: The expansion-card slots are not hot-swappable.

The following table provides guidelines for installing expansion cards to ensure proper cooling and mechanical fit. The expansion cards with the highest priority should be installed first using the slot priority indicated. All the other expansion cards should be installed in the card priority and slot priority order.

Table 18. No riser configuration (Slot 1)

Card type	Slot priority	Maximum number of cards
PERC 9: Mini mono (H730P/H330)	Integrated slot	1
PERC 10: Mini mono (H740P)	Integrated slot	1
PERC 11: Mini mono (H350)	Integrated slot	1
PERC 11: Mini mono (HBA350i)	Integrated slot	1
HBA: Mini mono (HBA330)	Integrated slot	1
LOM riser (2x1 G)/(2x10 G)/(2x25 G)	1	1

Table 19. Riser configuration (include slots 1 and 3)

Card type	Slot priority	Maximum number of cards
PERC 9: Mini mono (H730P/H330)	Integrated slot	1
PERC 10: Mini mono (H740P)	Integrated slot	1
PERC 11: Mini mono (H350)	Integrated slot	1
PERC 11: Mini mono (HBA350i)	Integrated slot	1
PERC 10: External adapter (H840)	3	1
PERC 10: External adapter (H840) (FH or LP)	3	1
PERC 11: External adapter (HBA355E)	3	1
HBA: External adapter	3	1

Table 19. Riser configuration (include slots 1 and 3) (continued)

Card type	Slot priority	Maximum number of cards
NVME PCIE SSD	3	1
Broadcom (1 G QP)	3	1
Broadcom (10 G DP)	3	1
Broadcom (25 G DP)	3	1
Intel 10 G (BaseT DP)	3	1
Intel 10 G (SFP+ DP)	3	1
Intel 1 G (QP)	3	1
Intel 25 G (SFP DP)	3	1
Emulex (HBA: FC64 LP)	3	1
Emulex (FC32 2P/1P)	3	1
Emulex (FC16 1P)/(FC16 2P)	3	1
Emulex (HBA FC32 1P S28)	2, 3	2
Mellanox 100 G (CX5/CX6 H100)	3	1
Mellanox 25 G (CX4LX DP/CX5 DP)	3	1
Qlogic (HBA FC32 SP/DP)	3	1
Qlogic (HBA FC16 SP/DP)	3	1
HBA: CRD,CT,MRVL,LP,FC32,1P,S28,F1	3	1
Qlogic 10 G (SFP DP)	3	1
Qlogic 25 G (BaseT DP)	3	1
Internal storage (BOSS)	3	1
Nvidia T4 GPU (LP)	3	1
Solarflare 25 G (SFP DP)	3	1
LOM Riser (2x1 G)/(2x10 G)/(2x25 G)	1	1
NIC: 100Gb, CRD,NTWK,INTL,LP,100G,2P,Q29	3	1
NIC: 25Gb, CRD,NTWK,INTL,LP,25G,2P,S28	3	1
NIC: 100Gb, CRD,NTWK,BCME,LP,100G,2P,QSF	3	1
HBA: FC32, CRD,CTL,FC32,2P,LPE35002,EMX,L	3	1
HBA: FC32, CRD,CTL,EMLX,LP,1P,S28	3	1
NIC: 10Gb, CRD,NTWK,BCME,LP,10G,4P,BT	3	1
HBA: External Adapter, KIT,CRD,CTL,HBA,12GBPS-SAS	3	1

Table 20. Riser configuration (include slots 1, 2, and 3)

Card type	Slot priority	Maximum number of cards
PERC 9: Mini mono (H730P/H330)	Integrated slot	1

Table 20. Riser configuration (include slots 1, 2, and 3) (continued)

Card type	Slot priority	Maximum number of cards
PERC 10: Mini mono (H740P)	Integrated slot	1
PERC 11: Mini mono (H350)	Integrated slot	1
PERC 11: Mini mono (HBA350i)	Integrated slot	1
HBA: Mini mono (HBA330)	Integrated slot	1
PERC 10: External adapter (H840)	3, 2	2
PERC 10: External adapter (H840) (FH or LP)	3, 2	2
PERC 11: External adapter (HBA355E)	3, 2	2
HBA: External adapter	3, 2	2
NVME PCIE SSD	3, 2	2
Broadcom (1 G DP/1G QP)	3, 2	2
Broadcom (10 G DP)	3, 2	2
Broadcom (25 G DP)	3, 2	2
Intel 10 G (BaseT DP)	3, 2	2
Intel 10 G (SFP+ DP)	3, 2	2
Intel 1 G (QP)	3, 2	2
Intel 25 G (SFP DP)	3, 2	2
Emulex (HBA: FC64 LP)	3, 2	2
Emulex (FC32 2P)	3, 2	2
Emulex (FC32 1P)	2, 3	2
Emulex (FC16 1P)/(FC16 2P)	3, 2	2
Mellanox 100 G (CX5/CX6 H100)	3, 2	2
Mellanox 25 G (CX4LX DP/CX5 DP)	3, 2	2
Qlogic (HBA FC32 SP/DP)	3, 2	2
Qlogic (HBA FC16 SP/DP)	3, 2	2
HBA: CRD,CTL,MRVL,FH,FC32,1P,S28	3, 2	2
Qlogic 10 G (SFP DP)	3, 2	2
Qlogic 25 G (BaseT DP)	3, 2	2
Internal Storage (BOSS)	3, 2	1
Nvidia T4 GPU	3, 2	2
Solarflare 25 G (SFP DP)	3, 2	2
CRD,NTWK,INTL,LP,100G,2P,Q28,Intel, NIC: 100Gb	3,2	2
CRD,NTWK,INTL,LP,25G,2P,S28,F1	3, 2	2
CRD,CTL,FC32,2P,LPE35002,EMX,L,Emulex, HBA: FC32	3,2	2
HBA: CRD,CTL,EMLX,LP,FC32,1P,S28	3, 2	2
CRD,NTWK,BCME,LP,10G,4P,BT,Broadcom,NIC: 10Gb	2,3	2

Table 20. Riser configuration (include slots 1, 2, and 3) (continued)

Card type	Slot priority	Maximum number of cards
KIT,CRD,CTL,HBA,12GBPS-SAS,Dell,HBA: External Adapter	3,2	2
LOM riser (2x1 G)/(2x10 G)/(2x25 G)	1	1

Removing the expansion card risers

Prerequisites

1. Follow the safety guidelines listed in the [Safety instructions](#).
2. Follow the procedure listed in the [Before working inside your system](#).
3. [Remove the air shroud](#).
4. Disconnect any cables connected to the expansion card.

Steps

Hold the touch points, and lift the expansion card riser from the riser connector on the system board.



Figure 54. Removing the low profile left riser

NOTE: For low profile riser right, first loosen the captive screw and then holding the touch points lift the riser away from the system.

NOTE: The numbers on the image do not depict the exact steps. The numbers are for representation of sequence.

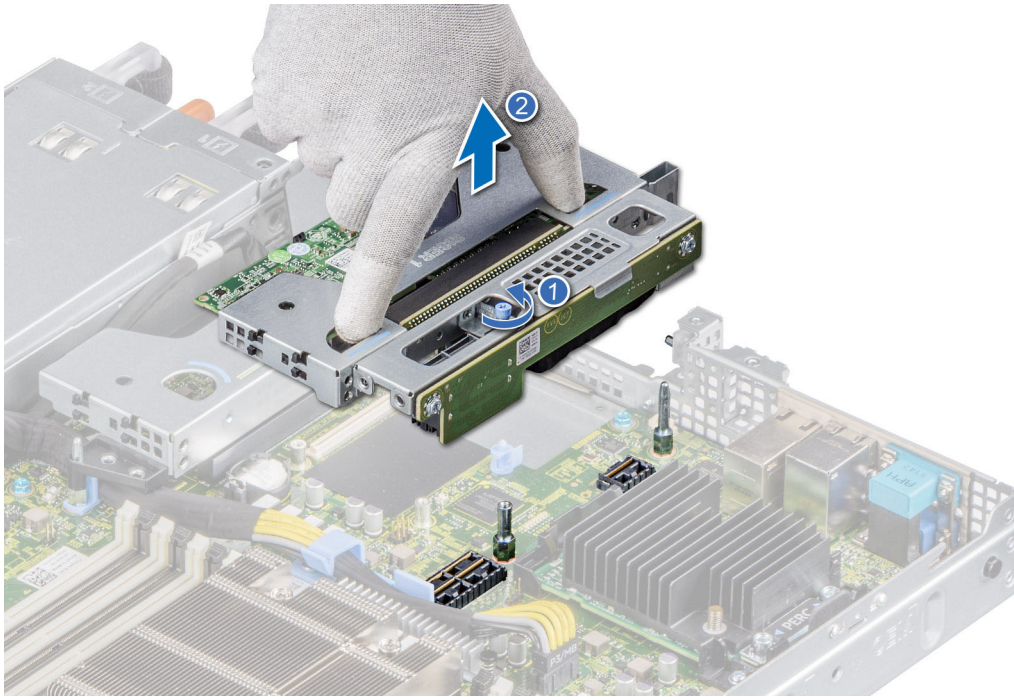

Figure 55. Removing the low profile right riser

Next steps

Replace the expansion card riser.

Installing the expansion card risers

Prerequisites

1. Follow the safety guidelines listed in the [Safety instructions](#).
2. Follow the procedure listed in the [Before working inside your system](#).
3. If removed, install the expansion cards into the expansion card risers.

Steps

1. Holding the touch points, align the expansion card riser with the connector and the riser guide pin on the system board.
2. Lower the expansion card riser into place until the expansion card riser connector is fully seated in the connector.

i **NOTE:** The numbers on the image do not depict the exact steps. The numbers are for representation of sequence.



Figure 56. Installing the low profile left riser

NOTE: For low profile riser right, tighten the captive screw to secure the riser to the system board.

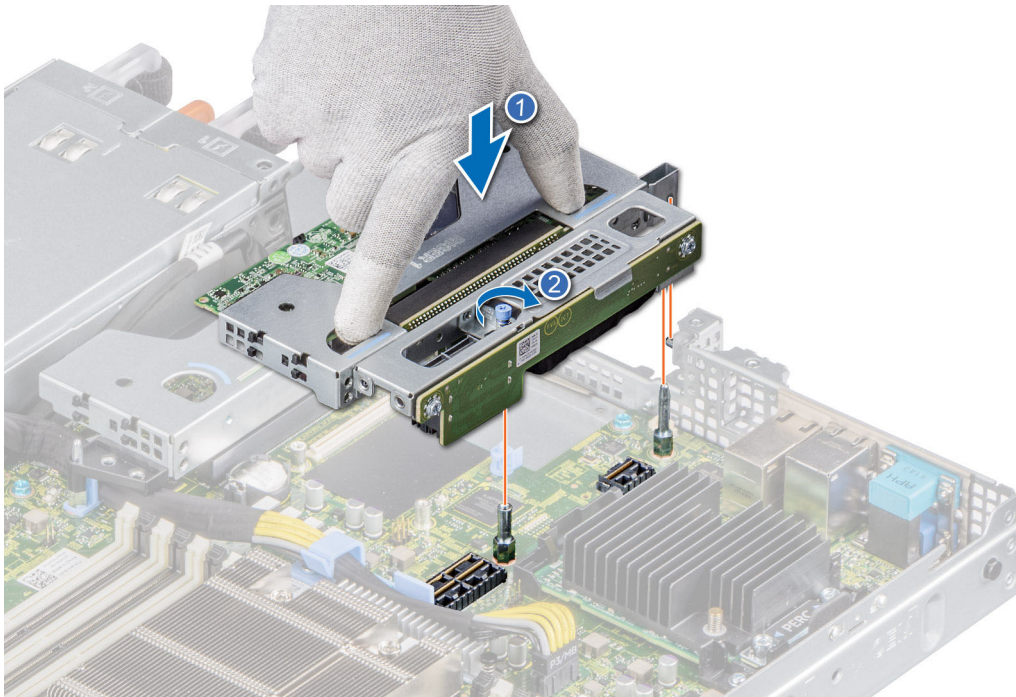

Figure 57. Installing the low profile right riser

Next steps

1. If required, re-connect the cables to the expansion card.
2. [Install the air shroud.](#)
3. Follow the procedure listed in [After working inside your system.](#)
4. Install any device drivers required for the card as described in the documentation for the card.

Removing expansion card from the expansion card riser

Prerequisites

1. Follow the safety guidelines listed in the [Safety instructions](#).
2. Follow the procedure listed in the [Before working inside your system](#).
3. [Remove the air shroud](#).
4. If applicable, disconnect the cables from the expansion card.

i **NOTE:** The procedure to remove the T4 GPU card and the expansion card is the same.

Steps

1. Pull and lift up the expansion card retention latch lock to open.
2. Hold the expansion card by its edges and pull the card until the card edge connector disengages from the expansion card connector on the riser.

i **NOTE:** The numbers on the image do not depict the exact steps. The numbers are for representation of sequence.

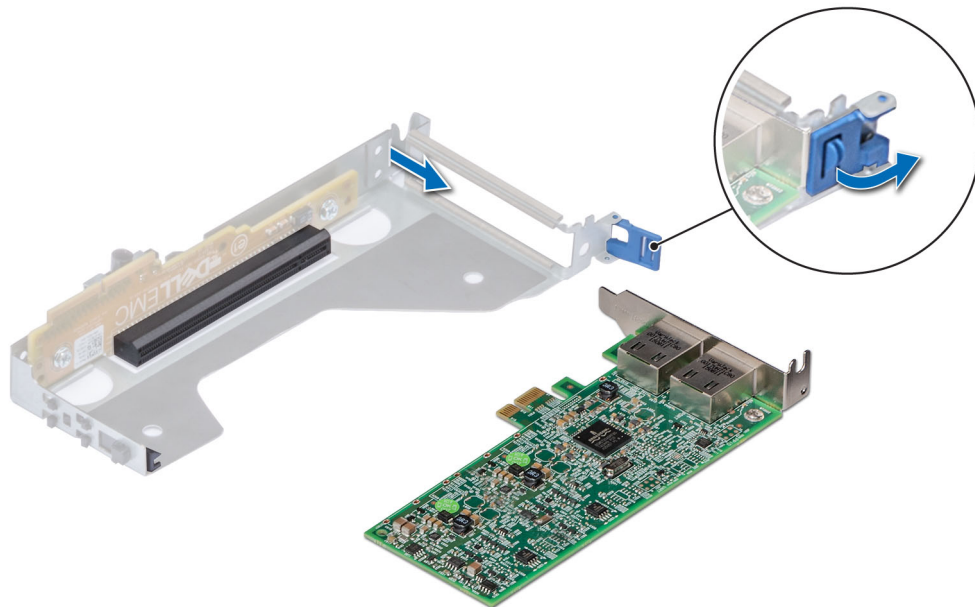

Figure 58. Removing an expansion card from the low profile left riser

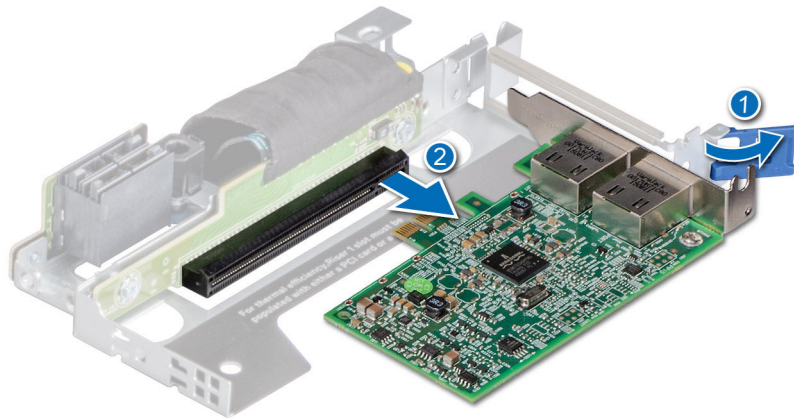

Figure 59. Removing an expansion card from the low profile right riser

3. If the expansion card is not going to be replaced, install a filler bracket and close the card retention latch.

i **NOTE:** You must install a filler bracket over an empty expansion card slot to maintain Federal Communications Commission (FCC) certification of the system. The brackets also keep dust and dirt out of the system and aid in proper cooling and airflow inside the system.

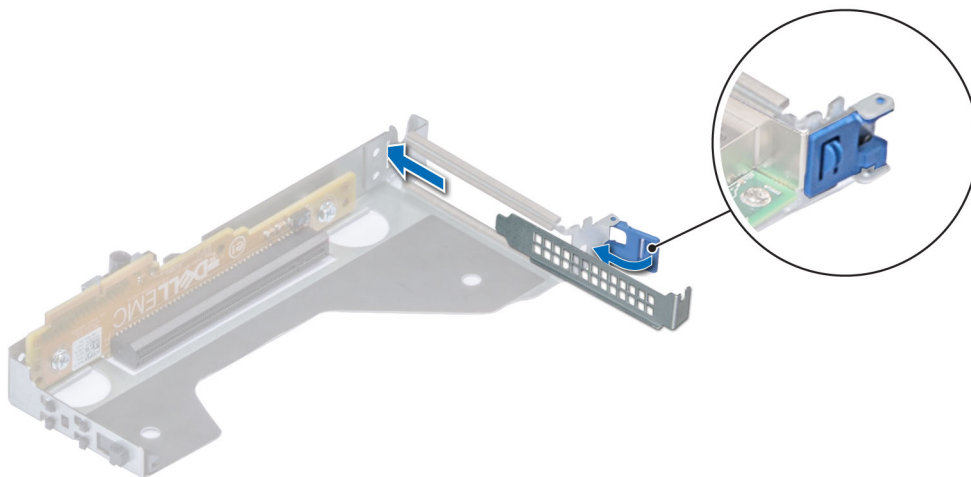

Figure 60. Installing filler bracket in the low profile left riser

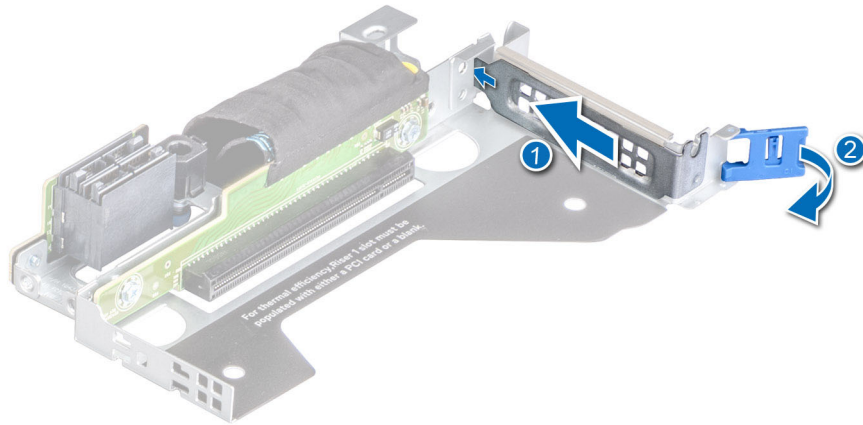

Figure 61. Installing filler bracket in the low profile right riser

Next steps

If applicable, install an expansion card into the expansion card riser.

Installing an expansion card into the expansion card riser

Prerequisites

1. Follow the safety guidelines listed in the [Safety instructions](#).
2. Follow the procedure listed in the [Before working inside your system](#).
3. If installing a new expansion card, unpack it and prepare the card for installation.

i **NOTE:** For instructions, see the documentation accompanying the card.

i **NOTE:** The procedure to install the T4 GPU card and the expansion card is the same.

Steps

1. Pull and lift up the expansion card retention latch lock to open.
2. If installed, remove the filler bracket.

i **NOTE:** Store the filler bracket for future use. Filler brackets must be installed in empty expansion card slots to maintain Federal Communications Commission (FCC) certification of the system. The brackets also keep dust and dirt out of the system and aid in proper cooling and airflow inside the system.

i **NOTE:** The numbers on the image do not depict the exact steps. The numbers are for representation of sequence.

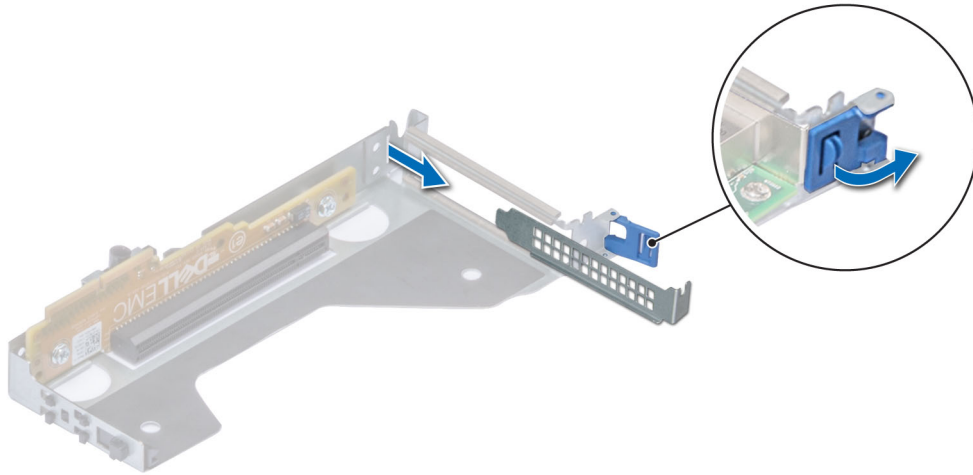

Figure 62. Removing a filler bracket from a low profile left riser

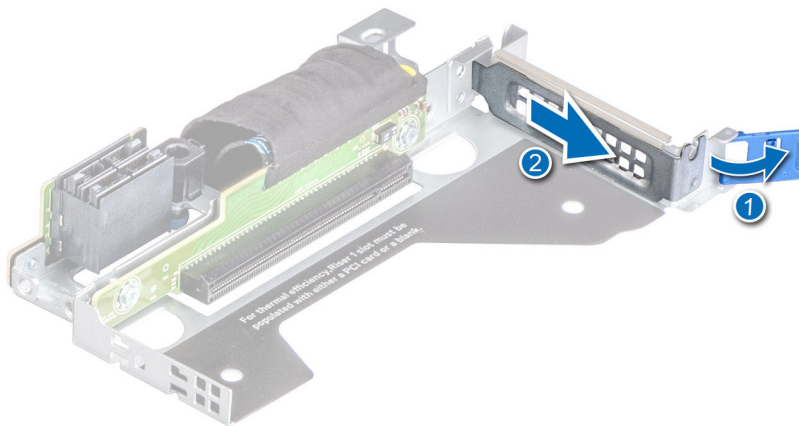

Figure 63. Removing a filler bracket from a low profile right riser

3. Hold the card by the edges, and align the card edge connector with the expansion card connector on the riser.
4. Insert the card edge connector firmly into the expansion card connector until the card is fully seated.
5. Close the expansion card retention latch.

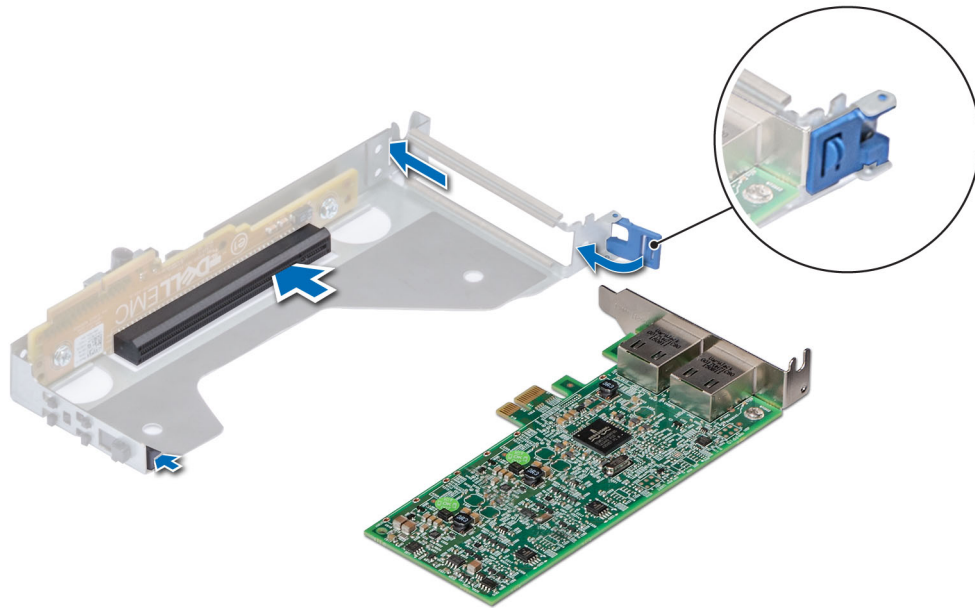

Figure 64. Installing an expansion card into a low profile left riser

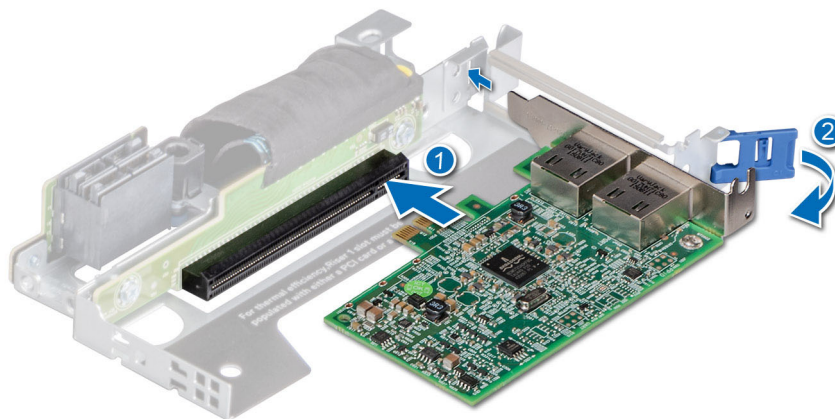

Figure 65. Installing an expansion card into a low profile right riser

Next steps

1. If applicable, connect the cables to the expansion card.
2. [Install the air shroud.](#)
3. Follow the procedure listed in [After working inside your system.](#)
4. Install any device drivers required for the card as described in the documentation for the card.

NOTE: While replacing faulty storage controller/FC/NIC card with the same type of card, after you power on the system; the new card automatically updates to the same firmware and configuration of the faulty one. For more information about the Part replacement configuration, see the *Lifecycle Controller User's Guide* at <https://www.dell.com/idracmanuals>

Micro SD card

Removing the MicroSD card

Prerequisites

1. Follow the safety guidelines listed in the [Safety instructions](#).
2. Follow the procedure listed in the [Before working inside your system](#).
3. [Remove the air shroud](#).
4. [Remove the IDSDM module](#).

Steps

1. Locate the MicroSD card slot on the IDSDM module, and press the card to partially release it from the slot. For more information on the slot location, see System board jumpers and connectors section.
2. Hold the MicroSD card and remove it from the slot..

 **NOTE:** Temporarily label each MicroSD card with its corresponding slot number after removal.

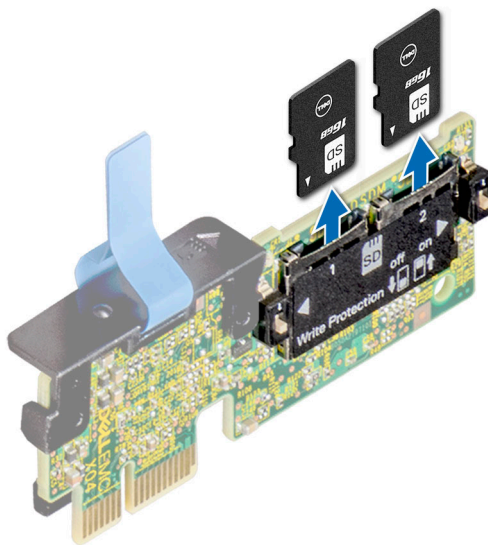

Figure 66. Removing the MicroSD card

Next steps

[Install the MicroSD cards](#).

Installing the MicroSD card

Prerequisites

1. Follow the safety guidelines listed in the [Safety instructions](#).
2. Follow the procedure listed in [Before working inside your system](#).
3. [Remove the air shroud](#).

 **NOTE:** To use an MicroSD card with your system, ensure that the **Internal SD Card Port** is enabled in System Setup.

 **NOTE:** Ensure that you install the MicroSD cards into the same slots based on the labels you had marked on the cards during removal.

Steps

1. Locate the MicroSD card slot on the IDSDM module. Orient the MicroSD card appropriately and insert the contact-pin end of the card into the slot. To locate IDSDM, see the System board jumpers and connectors section.

NOTE: The slot is keyed to ensure correct insertion of the card.

2. Press the card into the slot to lock it into place.

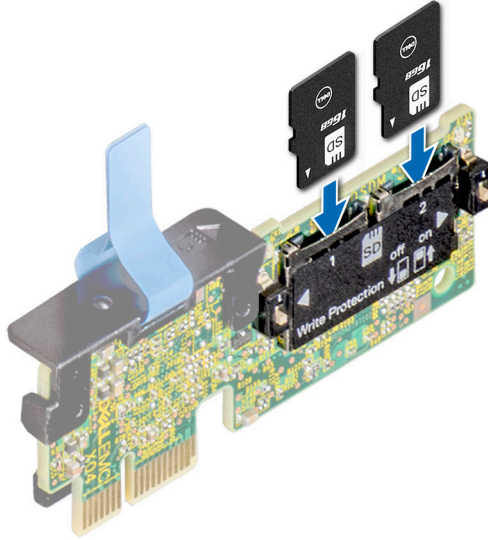

Figure 67. Installing the MicroSD card

Next steps

1. [Install the IDSDM module.](#)
2. [Install the air shroud.](#)
3. Follow the procedure listed in the [After working inside your system.](#)

M.2 SSD module on BOSS-S1 adapter card

Removing the M.2 SSD module

Prerequisites

1. Follow the safety guidelines listed in the [Safety instructions.](#)
2. Follow the procedure listed in the [Before working inside your system.](#)
3. [Remove the air shroud.](#)
4. Remove the BOSS card.

NOTE: The procedure to remove the BOSS card is similar to removing an expansion card.

Steps

1. Using the Phillips #1 screwdriver, remove the screws securing the M.2 SSD module to the BOSS card.
2. Pull the M.2 SSD module to disconnect from the connector on the BOSS card.

NOTE: The numbers on the image do not depict the exact steps. The numbers are for representation of sequence.

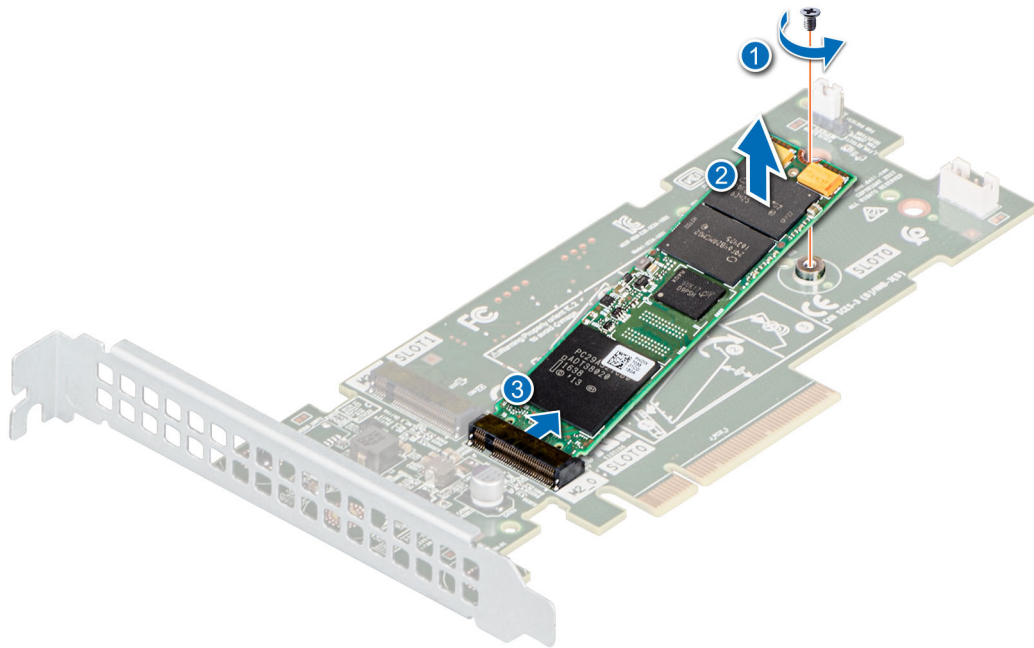

Figure 68. Removing the M.2 SSD module

Next steps

Replace the M.2 SSD module.

Installing the M.2 SSD module

Prerequisites

1. Follow the safety guidelines listed in the [Safety instructions](#).
2. Follow the procedure listed in the [Before working inside your system](#).
3. [Remove the air shroud](#).
4. Remove the BOSS card.

NOTE: The procedure to remove the BOSS card is similar to the removing an expansion card.

Steps

1. Align the M.2 SSD module at an angle with the connector on the BOSS card.
2. Insert the M.2 SSD module until it is firmly seated in the BOSS card connector.
3. Using the Phillips #1 screwdriver, secure the M.2 SSD module on the BOSS card with the screw.

NOTE: The numbers on the image do not depict the exact steps. The numbers are for representation of sequence.

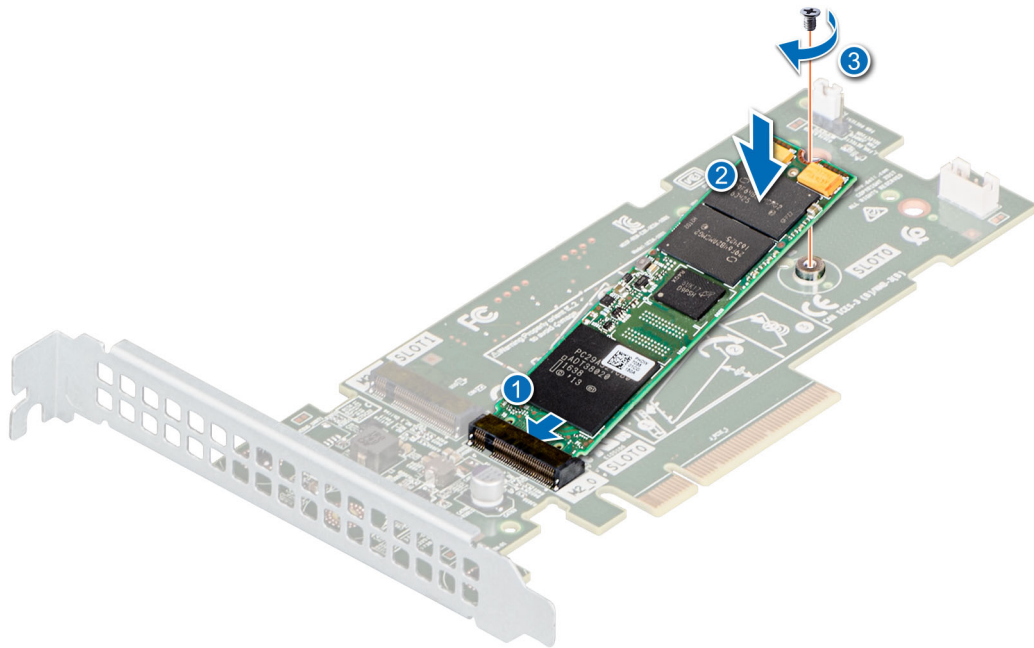

Figure 69. Installing the M.2 SSD module

Next steps

1. Install the BOSS card.
NOTE: The procedure to install the BOSS card is similar to removing an expansion card.
2. [Install the air shroud.](#)
3. Follow the procedure listed in the [After working inside your system.](#)

Optional IDSDM module

Removing the IDSDM module

Prerequisites

1. Follow the safety guidelines listed in the [Safety instructions.](#)
2. Follow the procedure listed in the [Before working inside your system.](#)
3. [Remove the air shroud.](#)
4. If you are replacing the IDSDM card, remove the MicroSD cards.
NOTE: Temporarily label each SD card with its corresponding slot number before removal. Reinstall the SD cards into the corresponding slots.

Steps

Holding the pull tab, lift the IDSDM card out of the system.

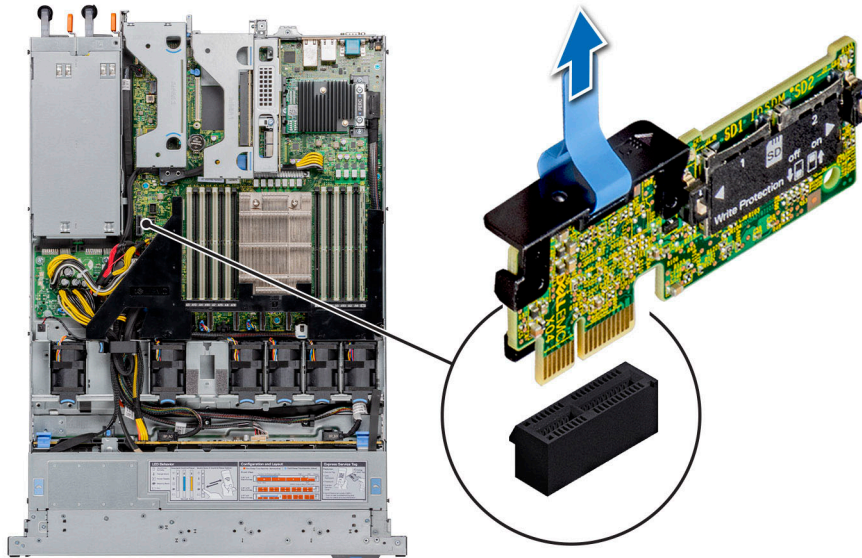

Figure 70. Removing the IDSDM module

Next steps

Replace the IDSDM module.

Installing the IDSDM module

Prerequisites

1. Follow the safety guidelines listed in the [Safety instructions](#).
2. Follow the procedure listed in the [Before working inside your system](#).
3. [Remove the air shroud](#).

Steps

1. Locate the IDSDM connector on the system board.
To locate IDSDM, see the System board jumpers and connectors section.
2. Align IDSDM module with the connector on the system board.
3. Push IDSDM module until it is firmly seated in the connector on the system board.

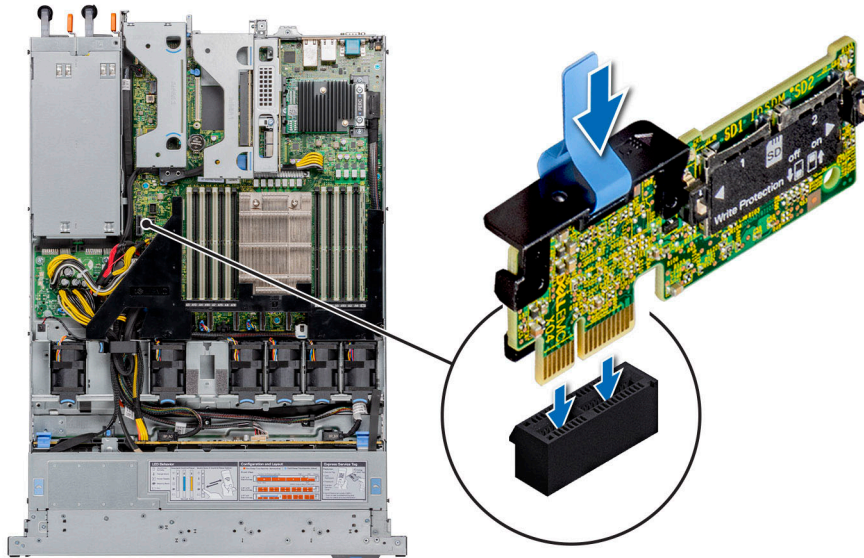

Figure 71. Installing the IDSDM module

Next steps

1. [Install the MicroSD cards.](#)
i **NOTE:** Reinstall the MicroSD cards into the same slots based on the labels you had marked on the cards during removal.
2. [Install the air shroud.](#)
3. Follow the procedure listed in the [After working inside your system.](#)

LOM riser card

Removing the LOM riser card

Prerequisites

1. Follow the safety guidelines listed in the [Safety instructions.](#)
2. Follow the procedure listed in the [Before working inside your system.](#)
3. [Remove the air shroud.](#)
4. If installed, remove the risers.

Steps

1. Using a Phillips #2 screwdriver, remove the screws that secure the LAN on Motherboard (LOM) riser card to the system board.
2. Push apart the two blue plastic clips securing the LOM riser card to release the riser.
3. Holding the LOM riser card by the edges, lift to disconnect the card from the connector on the system board.
4. Slide the LOM riser card towards the front of the system until the Ethernet connectors or the SFP+ are clear of the slot in the back panel.

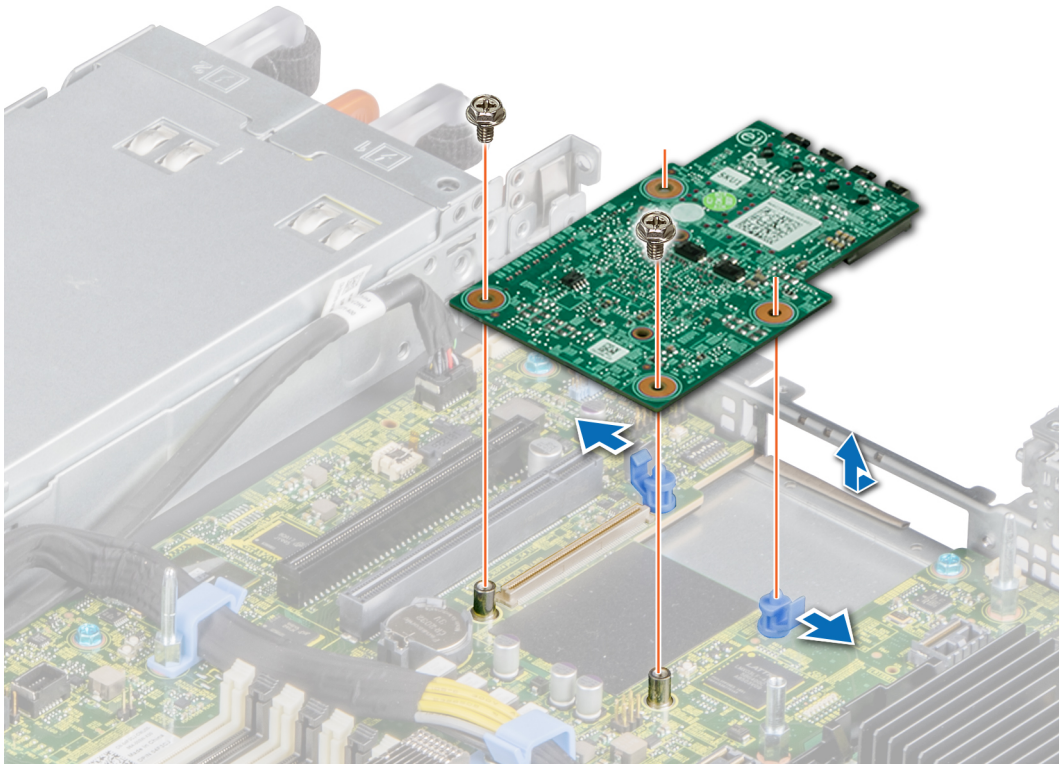

Figure 72. Removing the LOM riser card

5. Lift the LOM riser card out of the system.
6. Remove the LOM bracket.
 - a. Using the Phillips #2 screwdriver, remove the screw that secures the bracket to the chassis.
 - b. Slide the bracket out of the slot on the chassis.

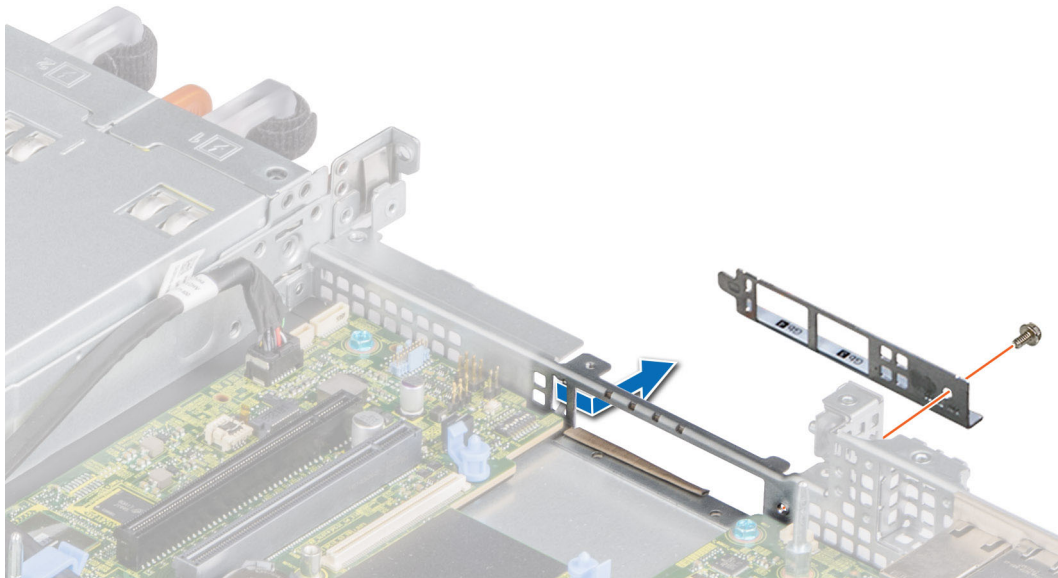

Figure 73. Removing the LOM riser bracket

7. If the LOM riser is not being replaced immediately, install the LOM filler bracket.
 - a. Insert and slide the filler into the slot on the chassis.
 - b. Using the Phillips #2 screwdriver, secure the filler bracket to the chassis with a screw.

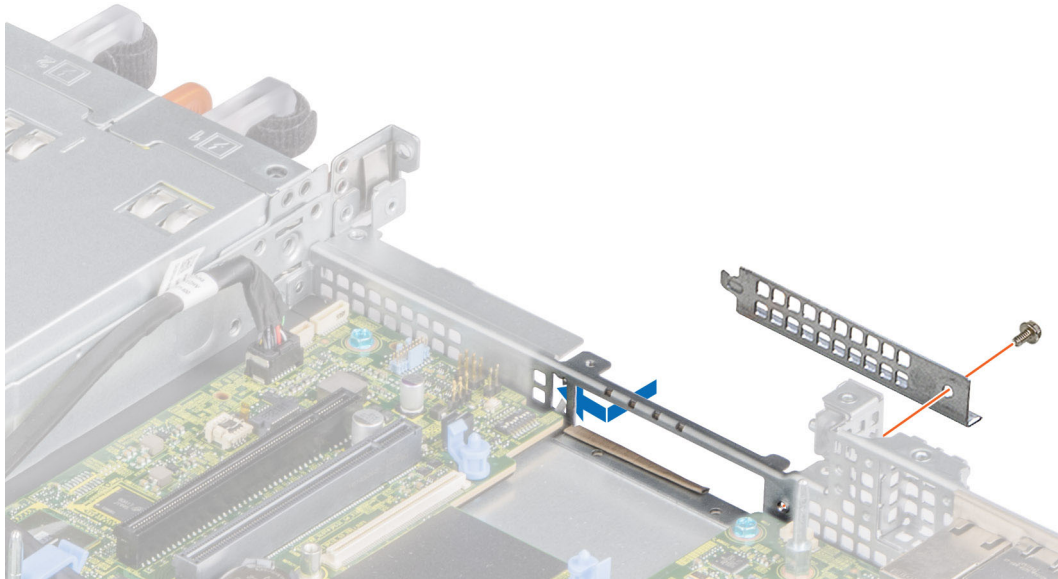

Figure 74. Installing the LOM filler bracket

Next steps

Replace the LOM riser card.

Installing the LOM riser card

Prerequisites

1. Follow the safety guidelines listed in the [Safety instructions](#).
2. Follow the procedure listed in the [Before working inside your system](#).
3. [Remove the air shroud](#).
4. If installed, remove the risers.

Steps

1. Remove the LOM filler bracket.
 - a. Using the Phillips #2 screwdriver, remove the screw that secures the bracket to the system.
 - b. Slide the bracket out of the slot on the system.

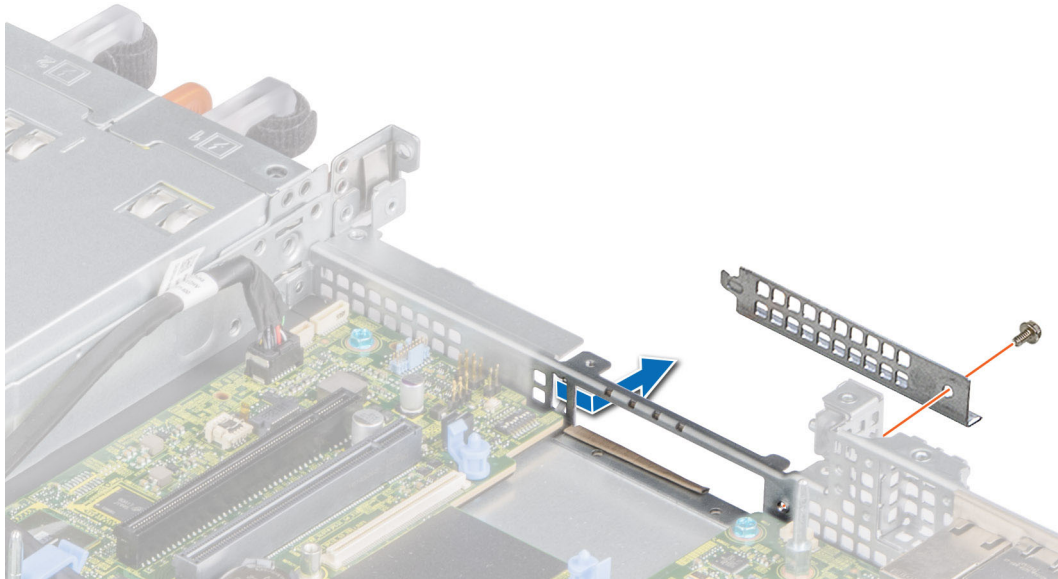

Figure 75. Removing the LOM filler bracket

2. Install the LOM bracket.
 - a. Insert and slide the LOM bracket into the slot on the system.
 - b. Using the Phillips #2 screwdriver, secure the bracket to the system with a screw

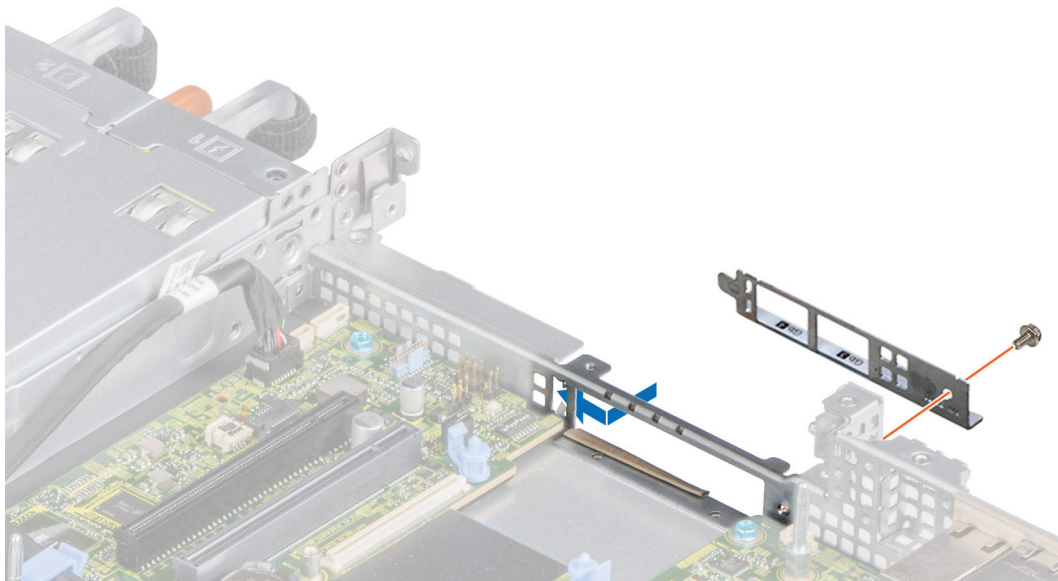

Figure 76. Installing the LOM riser bracket

3. Orient the LOM riser card to fit the Ethernet connectors or the SFP+ through the slot of the bracket.
4. Press the LOM riser card until the card is firmly seated on the system board connector and the two blue plastic clips to secure the LOM riser card in place.
5. Using a Phillips #2 screwdriver, secure the LOM riser card to the system board with screws.

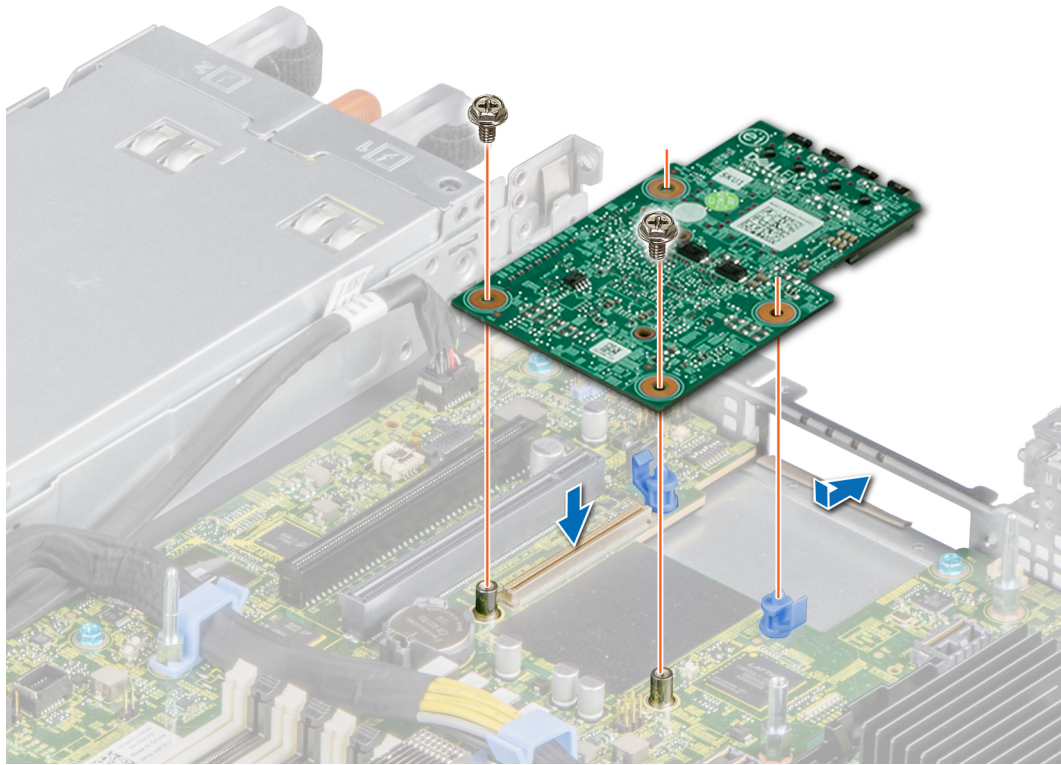

Figure 77. Installing the LOM riser card

Next steps

1. If removed, install the risers.
2. [Install the air shroud.](#)
3. Follow the procedure listed in [After working inside your system.](#)

i **NOTE:** While replacing faulty storage controller/FC/NIC card with the same type of card, after you power on the system; the new card automatically updates to the same firmware and configuration of the faulty one. For more information about the Part replacement configuration, see the *Lifecycle Controller User's Guide* at <https://www.dell.com/idracmanuals>

Mini PERC card

Removing the mini PERC card

Prerequisites

1. Follow the safety guidelines listed in the [Safety instructions.](#)
2. Follow the procedure listed in the [Before working inside your system.](#)
3. [Remove the air shroud.](#)
4. If installed, remove the risers..

Steps

1. Using a Phillips #2 screwdriver, loosen the screws that secure the cable to the mini PERC card.
2. Holding the tab, lift the cable to disconnect from the mini PERC card.

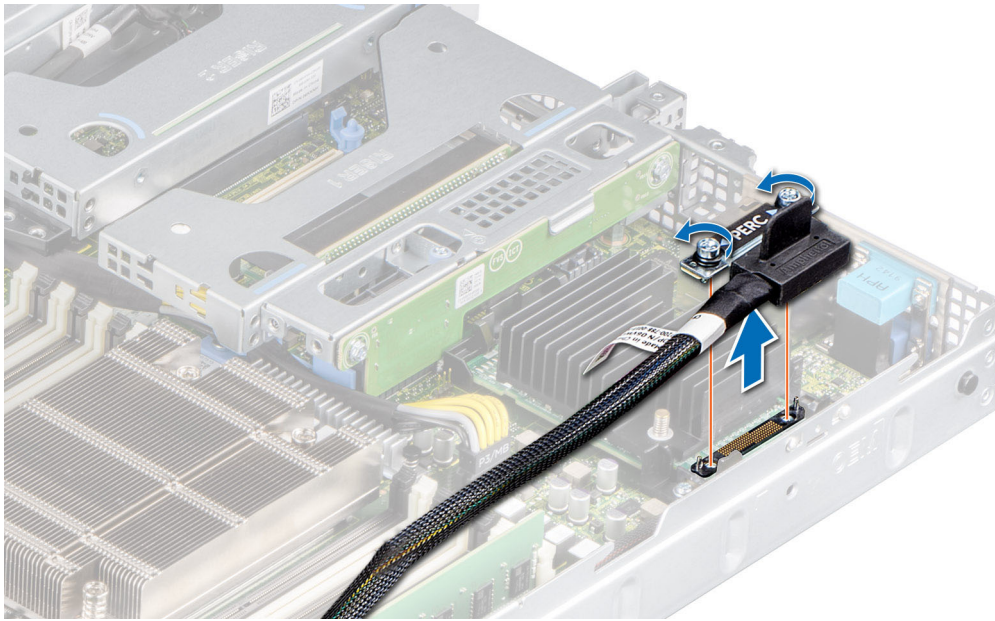

Figure 78. Removing the mini PERC card cable

3. Slide out the mini PERC card to disengage from the card holder on the system board.
4. Lift the mini PERC card out of the system.

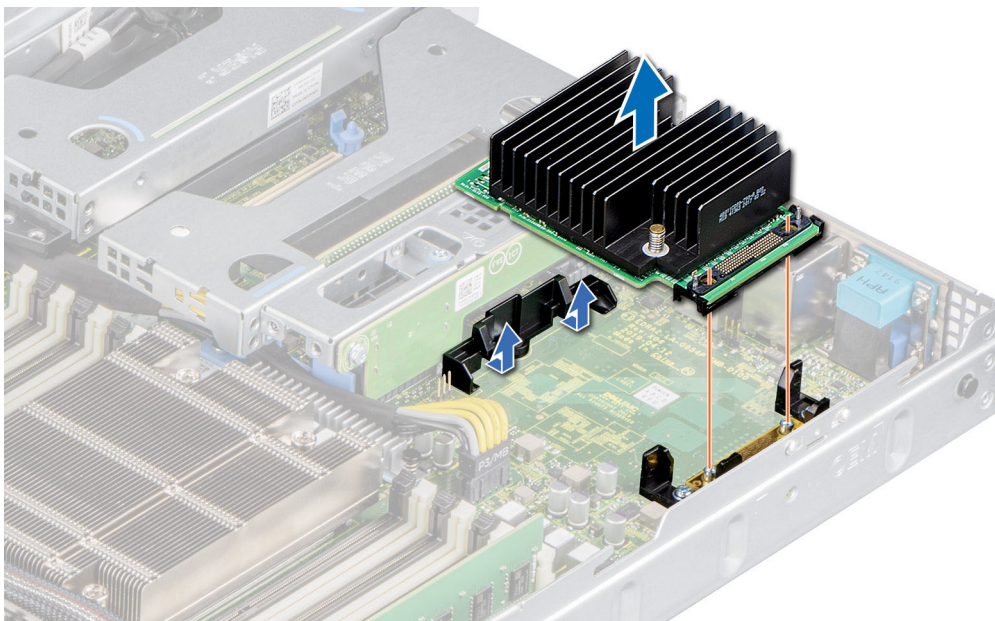

Figure 79. Removing the mini PERC card

Next steps

Replace the mini PERC card.

Installing the mini PERC card

Prerequisites

1. Follow the safety guidelines listed in the [Safety instructions](#).
2. Follow the procedure listed in [Before working inside your system](#).

Steps

1. Angle the mini PERC card to engage with the mini PERC card holder on the system board.
2. Lower the mini PERC card into place until the mini PERC card is firmly seated on the card holder.

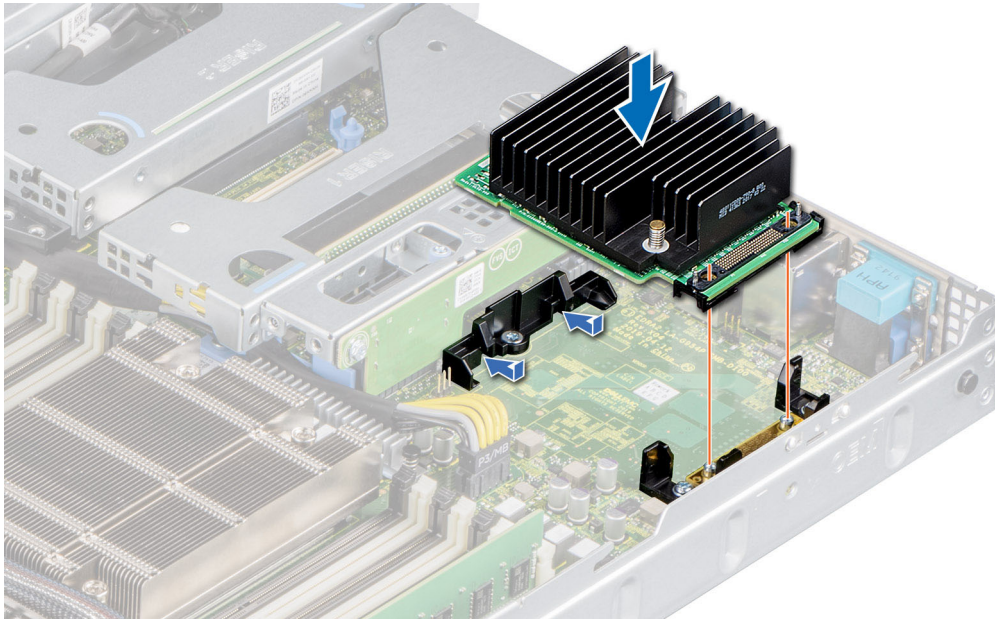

Figure 80. Installing the mini PERC card

3. Align the screws on the cable with the screw holes on the mini PERC card.
4. Using a Phillips #2 screwdriver, secure the cable to the mini PERC card with the screws.

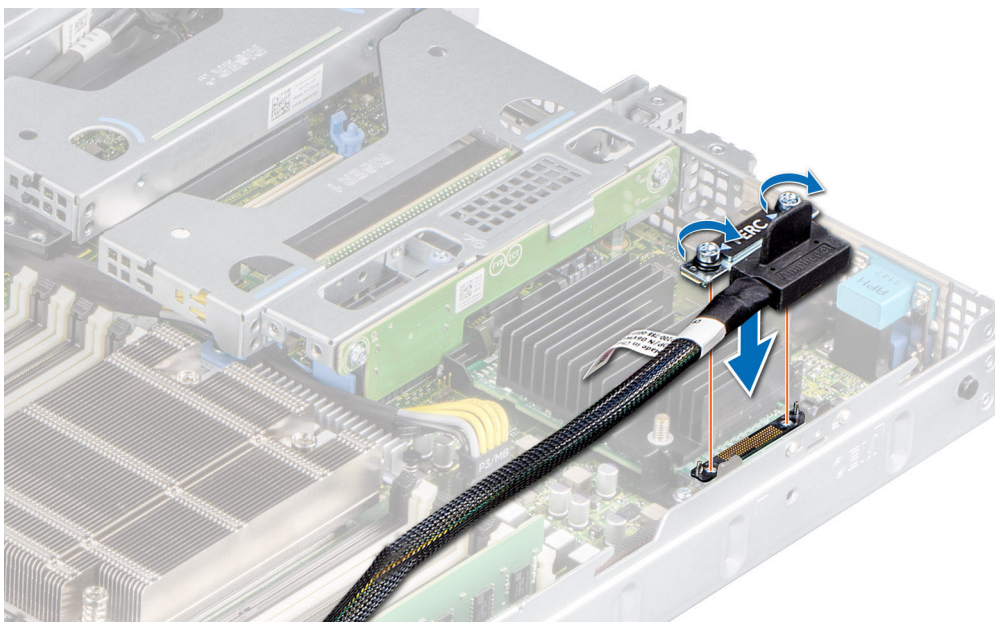

Figure 81. Installing the mini PERC card cable

Next steps

1. If removed, [install the expansion card risers](#).
2. [Install the air shroud](#).
3. Follow the procedure listed in the [After working inside your system](#).

NOTE: While replacing faulty storage controller/FC/NIC card with the same type of card, after you power on the system; the new card automatically updates to the same firmware and configuration of the faulty one. For more information about the Part replacement configuration, see the *Lifecycle Controller User's Guide* at <https://www.dell.com/idracmanuals>

System battery

Replacing the system battery

Prerequisites

WARNING: There is a danger of a new battery exploding if it is incorrectly installed. Replace the battery only with the same or equivalent type recommended by the manufacturer. Discard used batteries according to the manufacturer's instructions. See the Safety instructions. that came with your system for more information..

1. Follow the safety guidelines listed in the [Safety instructions](#).
2. Follow the procedure listed in the [Before working inside your system](#).
3. If applicable, disconnect the power or data cables from the expansion card(s).
4. [Remove the LOM riser card](#).

Steps

1. To remove the battery:
 - a. Use a plastic scribe to pry out the system battery.

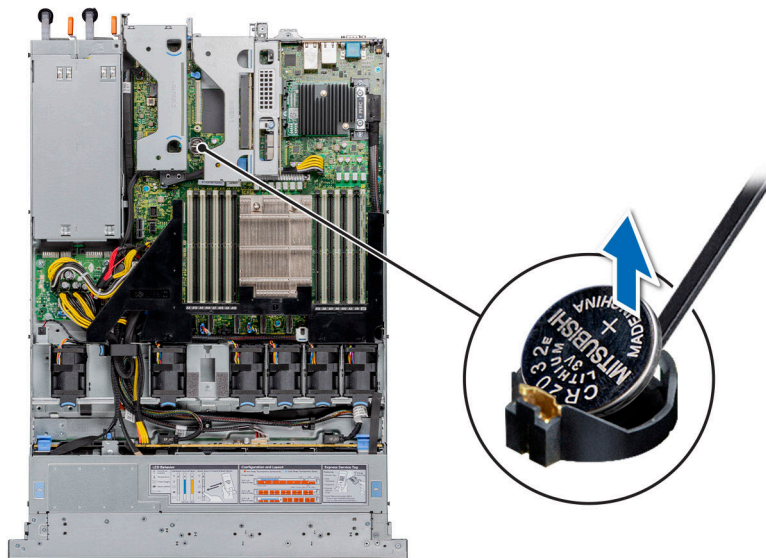

Figure 82. Removing the system battery

CAUTION: To avoid damage to the battery connector, you must firmly support the connector while installing or removing a battery.

2. To install a new system battery:
 - a. Hold the battery with the positive side facing up and slide it under the securing tabs.
 - b. Press the battery into the connector until it snaps into place.

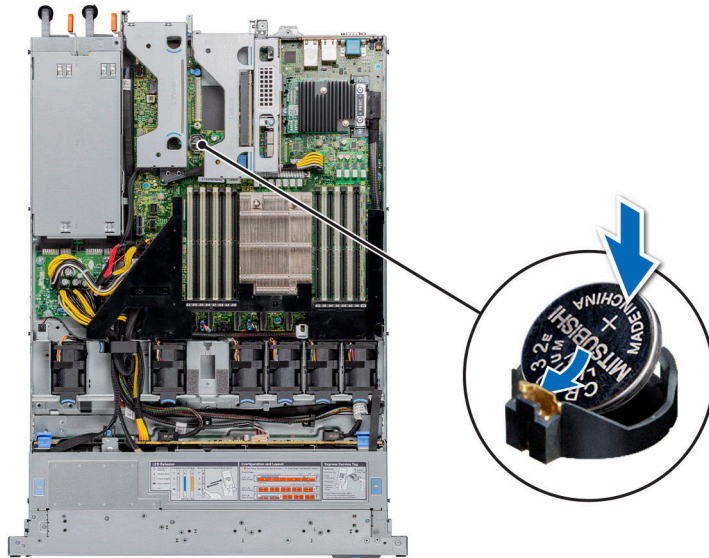

Figure 83. Installing the system battery

Next steps

1. Install the LOM riser card.
2. If applicable, connect the cables to the expansion card(s).
3. Follow the procedure listed in the [After working inside your system](#).
4. Confirm that the battery is operating properly, by performing the following steps:
 - a. Enter the System Setup, while booting, by pressing F2.
 - b. Enter the correct time and date in the System Setup **Time** and **Date** fields.
 - c. **Exit** the System Setup.
 - d. To test the newly installed battery, remove the system from the enclosure for at least an hour.
 - e. Reinstall the system into the enclosure after an hour.
 - f. Enter the System Setup and if the time and date are still incorrect, see [Getting help](#) section.

Optional internal USB memory key

NOTE: To locate the internal USB port on the system board, see the [System board jumpers and connectors](#) section.

Replacing optional internal USB memory key

Prerequisites

CAUTION: To avoid interference with other components in the server, the maximum permissible dimensions of the USB memory key are 15.9 mm wide x 57.15 mm long x 7.9 mm high.

1. Follow the safety guidelines listed in the [Safety instructions](#).
2. Follow the procedure listed in the [Before working inside your system](#).
3. [Remove the air shroud](#).

Steps

1. Locate the USB port or USB memory key on the system board.
To locate the internal USB port on the system board, see the [System board jumpers and connectors](#) section.
2. If installed, remove the USB memory key from the USB port.

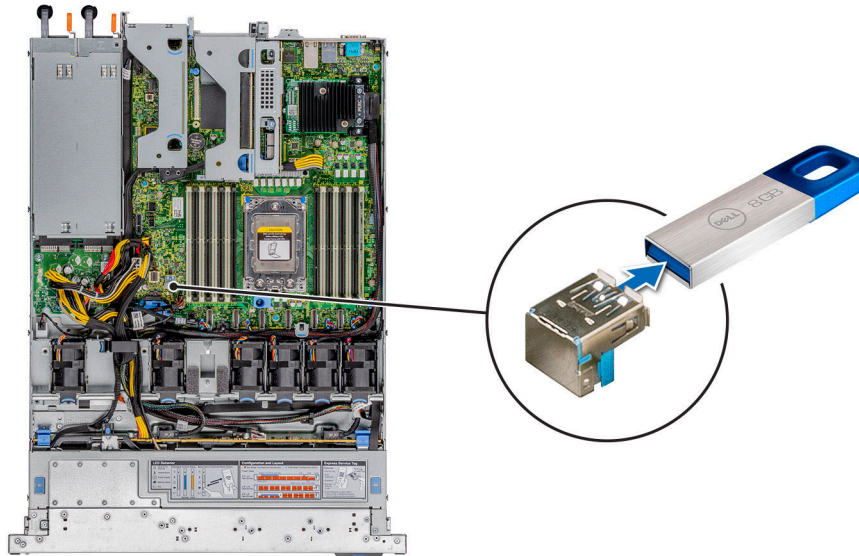

Figure 84. Removing the USB memory key

3. Insert the replacement USB memory key into the USB port.

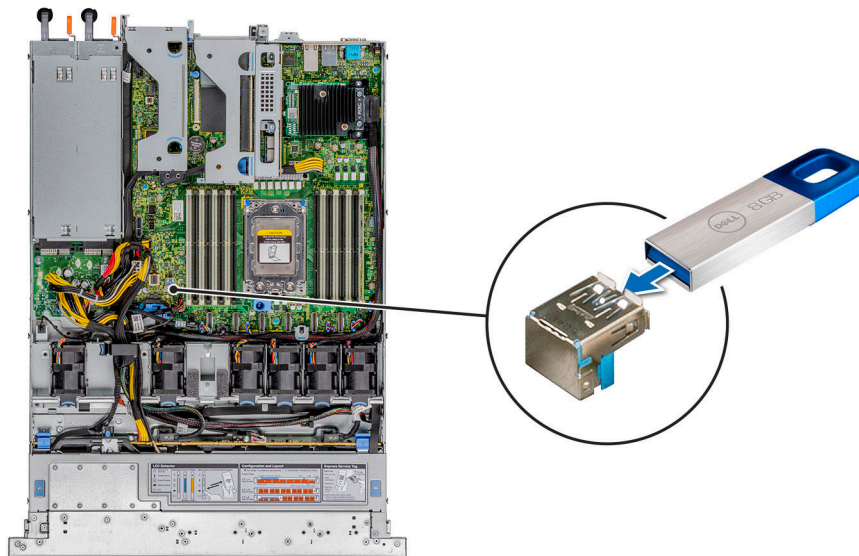

Figure 85. Installing the USB memory key

Next steps

1. [Install the air shroud.](#)
2. Follow the procedure listed in [After working inside your system.](#)
3. While booting, press F2 to enter **System Setup** and verify that the system detects the USB memory key.

VGA module

Removing the VGA module

Prerequisites

1. Follow the safety guidelines listed in the [Safety instructions](#).
2. Follow the procedure listed in the [Before working inside your system](#).
3. [Remove the front bezel](#).
4. [Remove the backplane cover](#).
5. [Remove the air shroud](#).
6. Disconnect the VGA cable from the VGA connector on the system board. For locating the connector, see the [System board jumpers and connectors](#) section.

NOTE: Ensure that you note the routing of the cables as you remove them from the system board. Route the cable properly when you replace it to prevent the cable from being pinched or crimped

Steps

1. Using Phillips #1 screwdriver, remove the screw on the VGA module.
2. Slide the module out of the system.

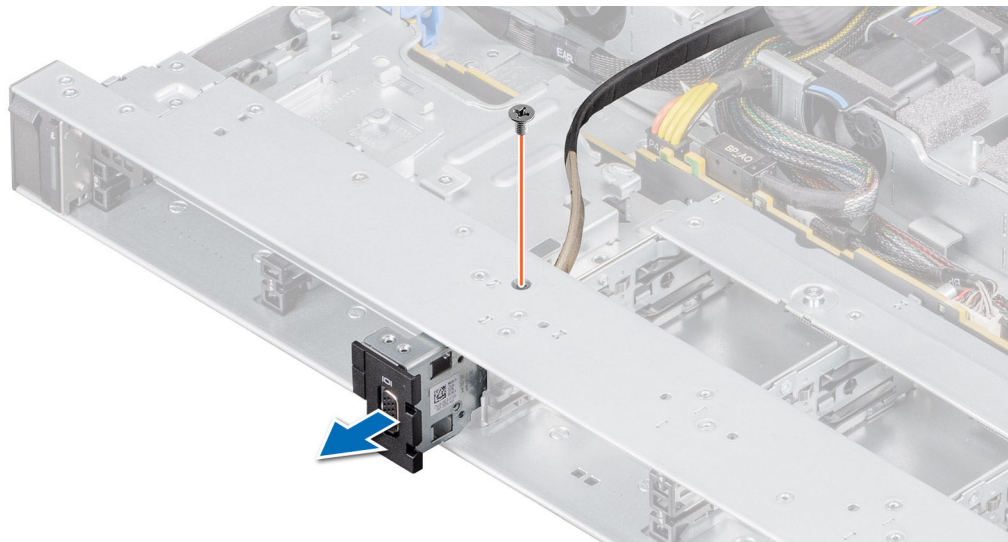

Figure 86. Removing the VGA module

Next steps

Install the VGA module.

Installing the VGA module

Prerequisites

1. Follow the safety guidelines listed in the [Safety instructions](#).
2. Follow the procedure listed in the [Before working inside your system](#).
3. [Remove the front bezel](#).
4. [Remove the backplane cover](#).
5. [Remove the air shroud](#).

NOTE: Ensure that you note the routing of the cables as you remove them from the system board. Route the cable properly when you replace it to prevent the cable from being pinched or crimped

Steps

1. Route the VGA cable through the VGA module slot on the front of the system and slide the VGA module into the slot.
2. Align the hole on the module with the screw hole on the system.
3. Using the Phillips #1 screwdriver, secure the VGA module to the system with the screw.

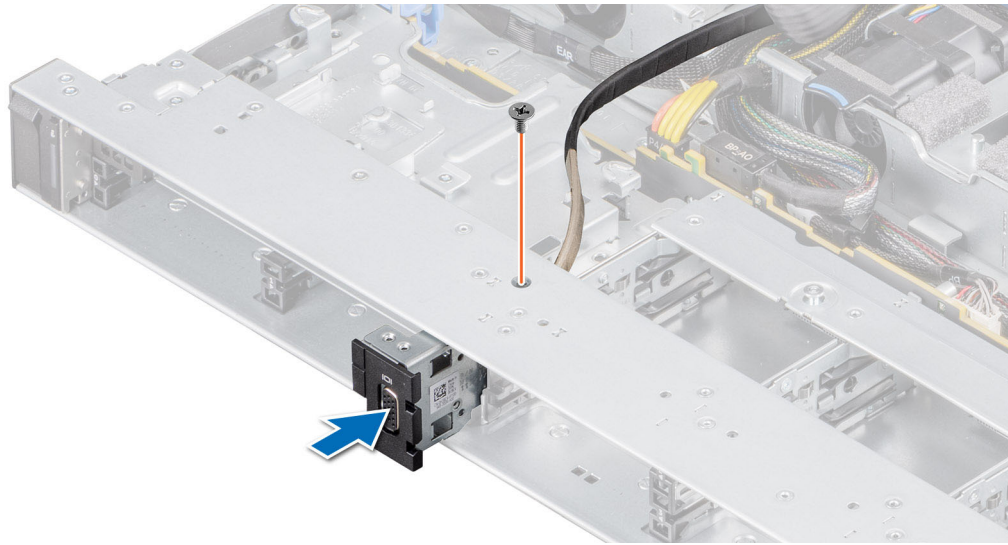

Figure 87. Installing the VGA module

Next steps

1. Route the VGA cable and connect it to the VGA connector on the system board. For locating the connector, see the [System board jumpers and connectors](#) section.
2. [Install the air shroud.](#)
3. [Install the backplane cover.](#)
4. [Install the front bezel.](#)
5. Follow the procedure listed in the [After working inside your system.](#)

Optional optical drive

Removing the optical drive

The procedure for removing an optical drive and optical drive blank is the same.

Prerequisites

1. Follow the safety guidelines listed in the [Safety instructions.](#)
2. Follow the procedure listed in the [Before working inside your system.](#)
3. If installed, [remove the front bezel.](#)

Steps

1. Disconnect the power and data cables from the connectors on the optical drive.

NOTE: Observe the routing of the cable as you remove it from the system.

2. To release the optical drive, press the release tab and push the drive towards the front of the system.
3. Slide the optical drive out of the system.

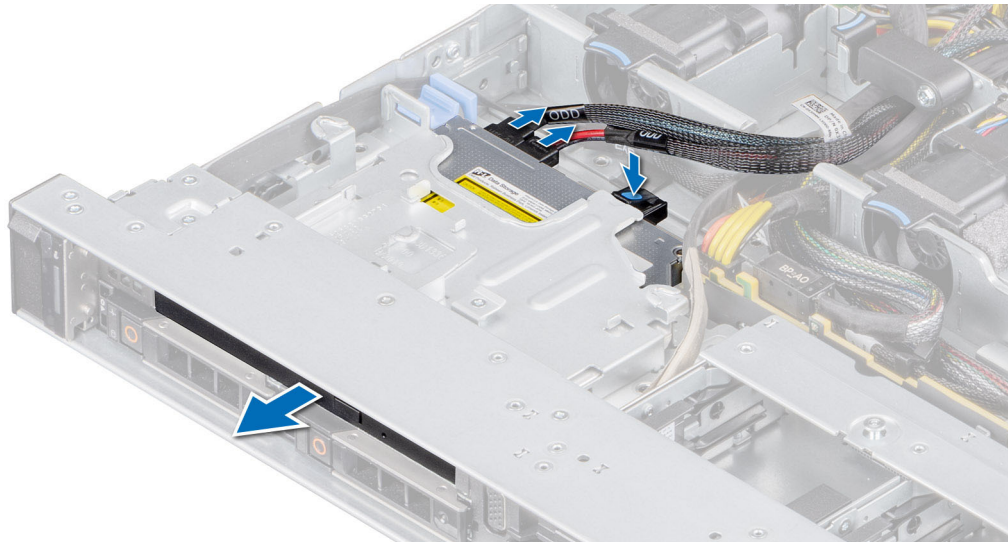

Figure 88. Removing the optical drive

Next steps

Replace the optical drive or Install an optical blank.

i NOTE:

Blanks must be installed on empty optical drive slot to maintain FCC certification of the system. The blank also keep dust and dirt out of the system and aid in proper cooling and airflow inside the system.

Installing the optical drive

The procedure for installing an optical drive and optical drive blank.

Prerequisites

1. Follow the safety guidelines listed in the [Safety instructions](#).
2. Follow the procedure listed in the [Before working inside your system](#).
3. If applicable, [remove the backplane cover](#).
4. If installed, remove the optical drive blank by pressing the blue release tab at the back of the blank and pushing the blank out of the system.

i NOTE: Route the cable properly when you replace it to prevent the cable from being pinched or crimped.

Steps

1. Insert the optical drive until the blue release tab locks in the slot on the system.
2. Align the optical drive with the optical drive slot on the front of the system.

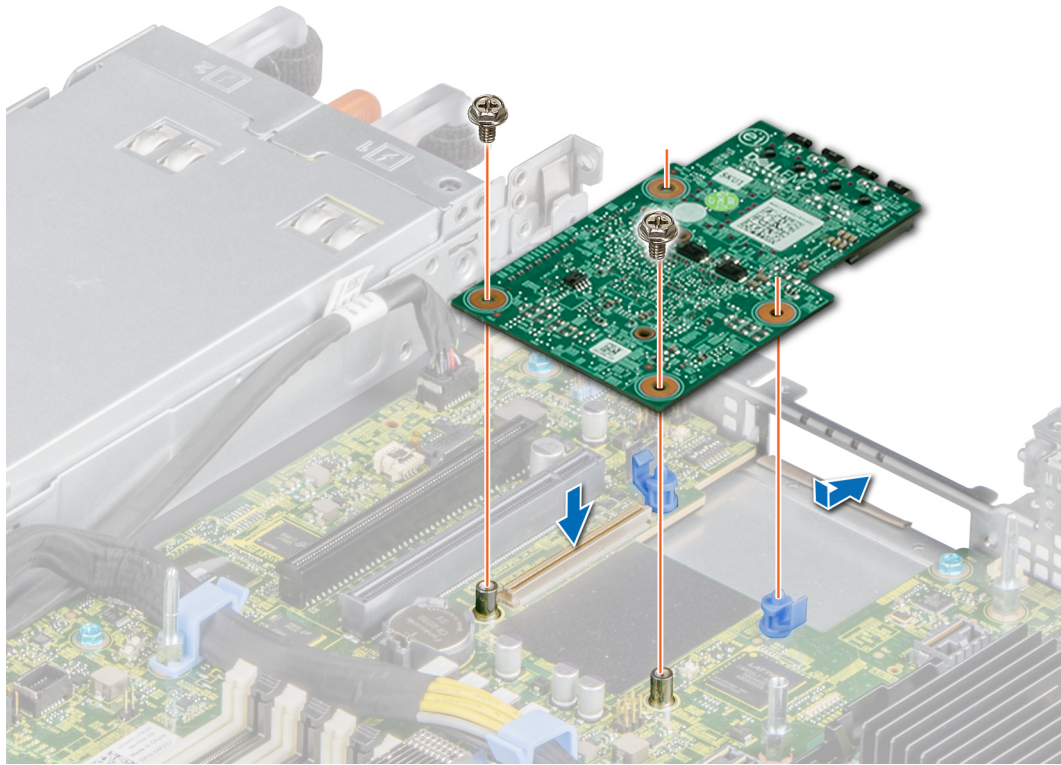

Figure 89. Installing the optical drive

NOTE:

Route the cable properly to prevent the cable from being pinched or crimped.

3. Connect the power and data cables to the connectors on the system board.

Next steps

1. If removed, install the front bezel.
2. Follow the procedure listed in [After working inside your system](#).

Power supply unit

NOTE: While replacing the hot swappable PSU, after next server boot; the new PSU automatically updates to the same firmware and configuration of the replaced one. For more information about the Part replacement configuration, see the *Lifecycle Controller User's Guide* at <https://www.dell.com/idracmanuals>

NOTE: Ensure to install the latest iDRAC 4.4x version or any later versions to support the 700 W PSU.

Hot spare feature

Your system supports the hot spare feature that significantly reduces the power overhead associated with power supply unit (PSU) redundancy.

When the hot spare feature is enabled, one of the redundant PSUs is switched to the sleep state. The active PSU supports 100 percent of the system load, thus operating at higher efficiency. The PSU in the sleep state monitors output voltage of the active PSU. If the output voltage of the active PSU drops, the PSU in the sleep state returns to an active output state.

If having both PSUs active is more efficient than having one PSU in the sleep state, the active PSU can also activate the sleeping PSU.

The default PSU settings are as follows:

- If the load on the active PSU is more than 50 percent of PSU rated power wattage, then the redundant PSU is switched to the active state.
- If the load on the active PSU falls below 20 percent of PSU rated power wattage, then the redundant PSU is switched to the sleep state.

You can configure the hot spare feature by using the iDRAC settings. For more information, see the *iDRAC User's Guide* available at www.dell.com/poweredgemanuals.

Removing a power supply unit blank

Prerequisites

Follow the safety guidelines listed in the [Safety instructions](#).

Steps

Pull the blank out of the system.

CAUTION: To ensure proper system cooling, the PSU blank must be installed in the second PSU bay in a non-redundant configuration. Remove the PSU blank only if you are installing a second PSU.

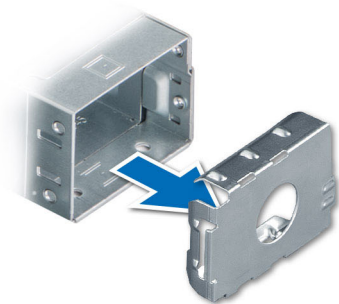

Figure 90. Removing a power supply unit blank

Next steps

Replace the PSU or PSU blank.

Installing a power supply unit blank

Prerequisites

1. Follow the safety guidelines listed in the [Safety instructions](#).
 - NOTE:** Install the power supply unit (PSU) blank only in the second PSU bay.
2. [Remove the PSU](#).

Steps

Align the PSU blank with the PSU bay and push it into the PSU bay until it clicks into place.

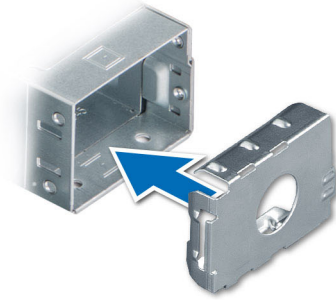

Figure 91. Installing a power supply unit blank

Installing a power supply unit

Prerequisites

1. Follow the safety guidelines listed in the [Safety instructions](#).
2. For systems that support redundant PSU, ensure that both the PSUs are of the same type and have the same maximum output power.

i **NOTE:** The maximum output power (shown in watts) is listed on the PSU label.

3. Remove the PSU blank.

Steps

Slide the PSU into the PSU bay until the release latch snaps into place.

i **NOTE:** The numbers on the image do not depict the exact steps. The numbers are for representation of sequence.



Figure 92. Installing a power supply unit

Next steps

1. If you have unlatched the cable management arm, relatch it. For information about the cable management arm, see the system's rack documentation at <https://www.dell.com/poweredge/manuals>.
2. Connect the power cable to the PSU, and plug the cable into a power outlet.

CAUTION: When connecting the power cable to the PSU, secure the cable to the PSU with the strap.

NOTE: When installing, hot swapping, or hot adding a new PSU, wait for 15 seconds for the system to recognize the PSU and determine its status. The PSU redundancy may not occur until discovery is complete. The PSU status indicator turns green to indicate that the PSU is functioning properly.

NOTE: For certain premium configurations with high power consumption, system PSU might stay with 2+0 mode only, 1+1 redundant mode is not available.

NOTE: While replacing the hot swappable PSU, after next server boot; the new PSU automatically updates to the same firmware and configuration of the replaced one. For more information about the Part replacement configuration, see the *Lifecycle Controller User's Guide* at <https://www.dell.com/idracmanuals>

NOTE: Ensure to install the latest iDRAC 4.4x version or any later versions to support the 700 W PSU.

Removing a power supply unit

Prerequisites

CAUTION: The system requires one power supply unit (PSU) for normal operation. On power-redundant systems, remove and replace only one PSU at a time in a system that is powered on.

1. Follow the safety guidelines listed in the [Safety instructions](#).
2. Disconnect the power cable from the power outlet and from the PSU you intend to remove.
3. Remove the cable from the strap on the PSU handle.
4. Unlatch and lift the optional cable management arm if it interferes with the PSU removal.

For information about the cable management arm, see the system's rack documentation at <https://www.dell.com/poweredgemanuals>.

Steps

Press the release latch, and holding the PSU handle slide the PSU out of the PSU bay.

NOTE: The numbers on the image do not depict the exact steps. The numbers are for representation of sequence.



Figure 93. Removing a power supply unit

Next steps

Replace the PSU or install the PSU blank.

Power interposer board

Removing the power interposer board

Prerequisites

1. Follow the safety guidelines listed in the [Safety instructions](#).
2. Follow the procedure listed in the [Before working inside your system](#).
3. [Remove the air shroud](#).
4. Remove the [PSU](#) or [PSU blank](#).

Steps

1. Using a Phillips #2 screwdriver, remove the screws securing the power interposer board (PIB) to the system.

 **NOTE:** Observe the routing of the cable as you remove it from the system.

2. Press the blue release latch on the PIB to release it from the hook on the PSU cage.

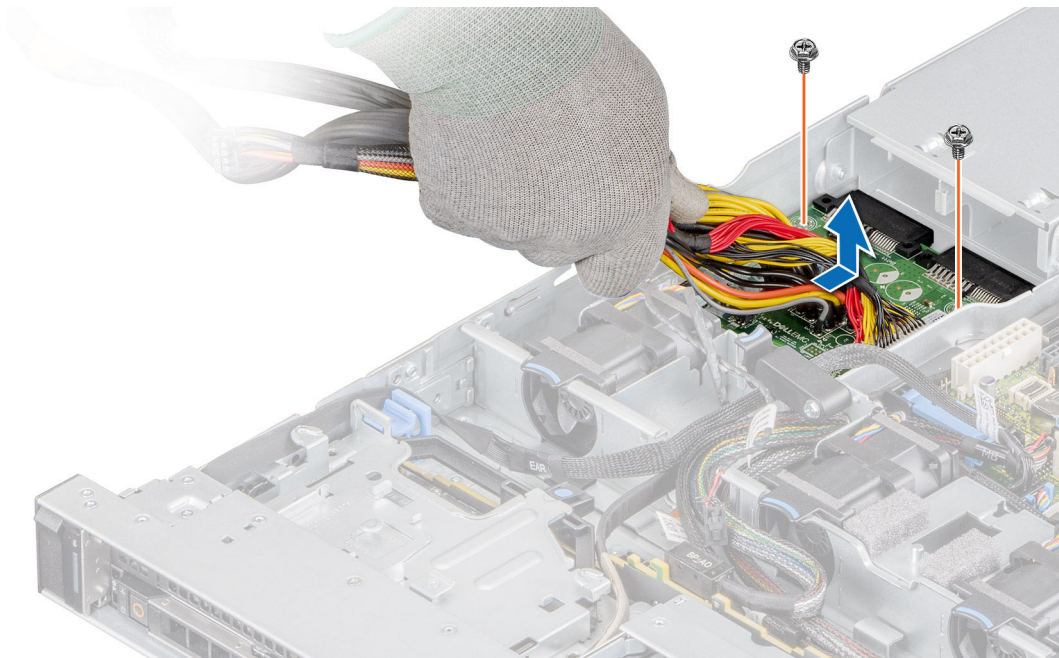

Figure 94. Removing the power interposer board

3. Lift the PIB away from the system.

Next steps

[Replace the power interposer board](#).

Installing the power interposer board

Prerequisites

1. Follow the safety guidelines listed in the [Safety instructions](#).
2. Follow the procedure listed in the [Before working inside your system](#).

Steps

1. Align the slots on the PIB with the hook on the PSU cage and slide it into place.

- Using Phillips #2 screwdriver, tighten the screws to secure the PIB to the system.

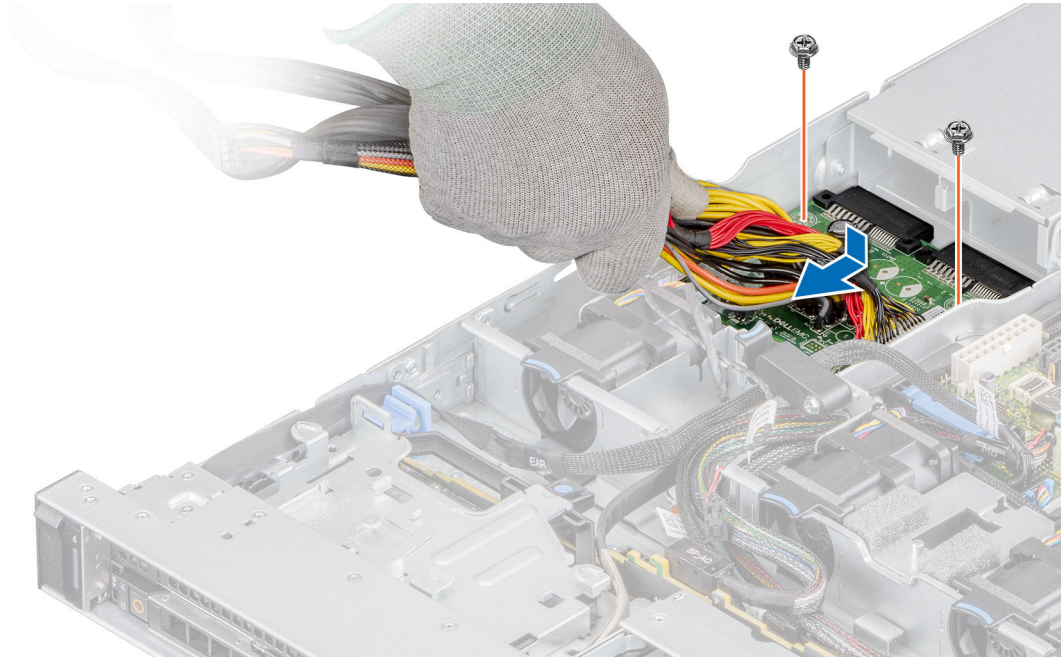

Figure 95. Installing the power interposer board

- Route the cables and connect it to the system board.

Next steps

- Install the PSU.
- Install the air shroud.
- Follow the procedure listed in [After working inside your system](#).

System board

Removing the system board

Prerequisites

CAUTION: If you are using the Trusted Platform Module (TPM) with an encryption key, you may be prompted to create a recovery key during program or System Setup. Be sure to create and safely store this recovery key. If you replace this system board, you must supply the recovery key when you restart your system or program before you can access the encrypted data on your drives.

- Follow the safety guidelines listed in the [Safety instructions](#).
- Follow the procedure listed in the [Before working inside your system](#).
- Remove the following components:
 - Air shroud
 - Expansion cards
 - Expansion card risers
 - Mini PERC card
 - IDSDM module
 - Internal USB key (if installed)
 - Processor
 - Heat sink
 - Memory modules
 - LOM riser card

- k. Disconnect all cables from the system board.

CAUTION: Take care not to damage the system identification button while removing the system board from the system.

Steps

1. Using a Phillips #2 screwdriver, remove the screws securing the system board to the chassis.
2. Using the system board holder, slightly lift the system board, and then slide it toward the front of the chassis.
3. Lift the system board out of the chassis.

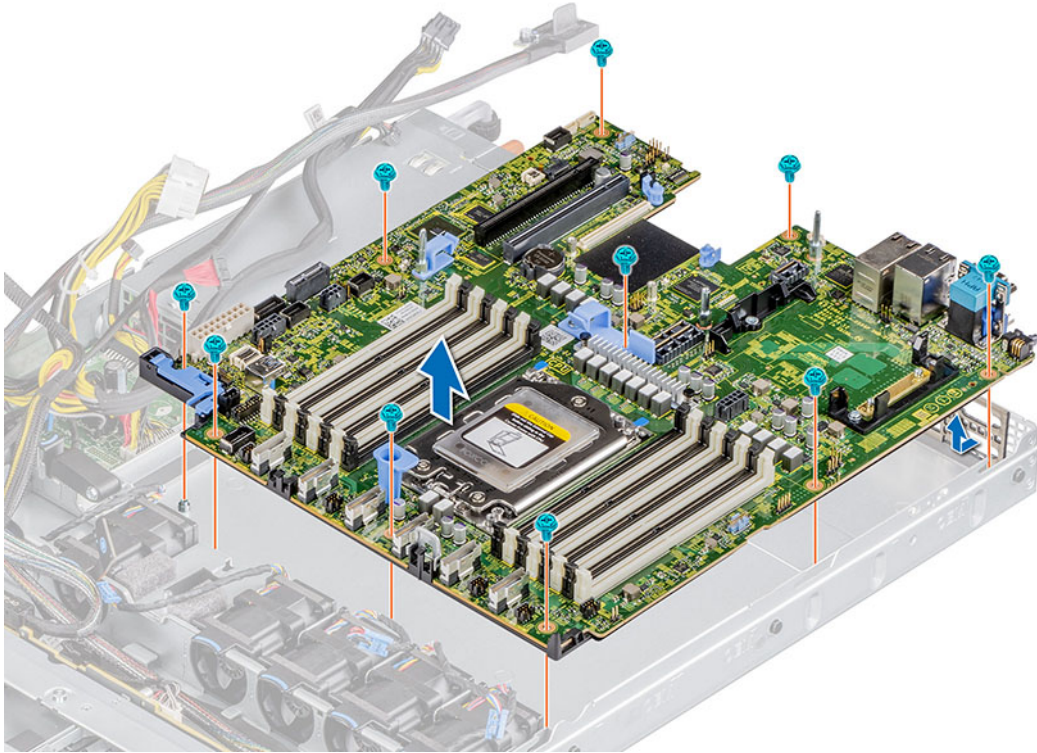

Figure 96. Removing the system board

Next steps

Install the system board.

Installing the system board

Prerequisites

NOTE: Before replacing the system board, replace the old iDRAC MAC address label in the Information tag with the iDRAC MAC address label of the replacement system board

1. Follow the safety guidelines listed in the [Safety instructions](#).
2. Follow the procedure listed in [Before working inside your system](#).
3. If you are replacing the system board, remove all the components that are listed in the [removing the system board](#) section.

Steps

1. Unpack the new system board assembly.

CAUTION: Do not lift the system board by holding a memory module, processor, or other components.

CAUTION: Take care not to damage the system identification button while placing the system board into the chassis.

2. Holding the system board holder, lower the system board into the system.
3. Incline the system board at an angle and align the connectors with the slots on the rear of the chassis.
4. Slide the system board towards the rear of the chassis until the connectors are firmly seated in the slots.
5. Using a Phillips #2 screwdriver, fasten the screws that secure the system board to the chassis.

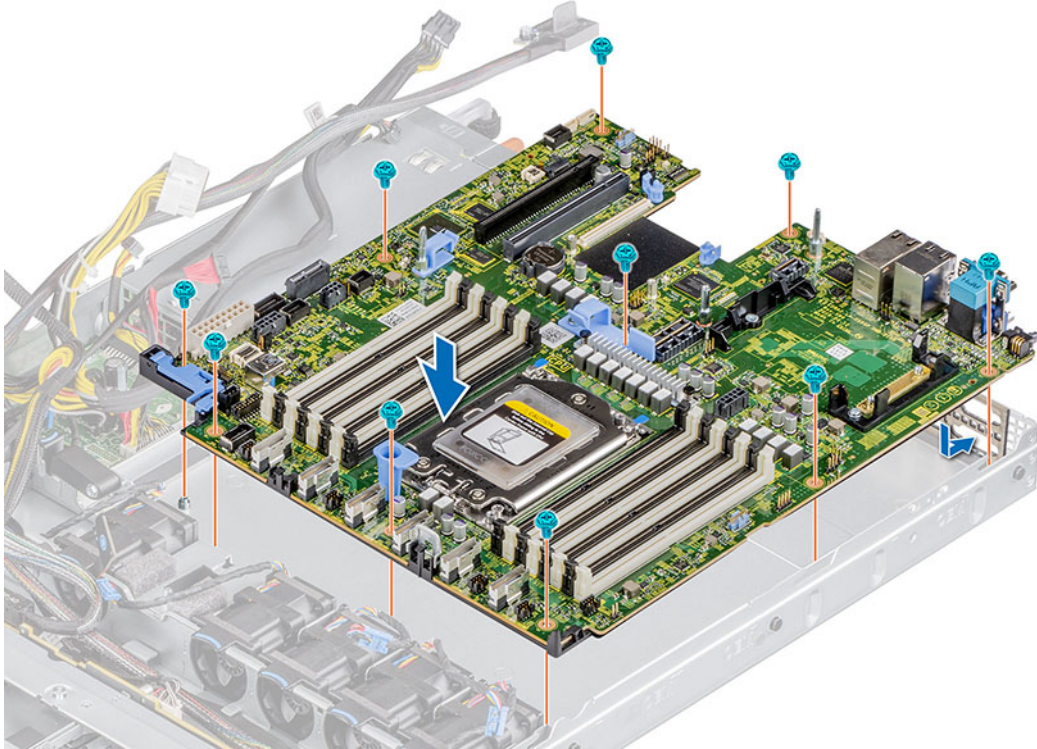

Figure 97. Installing the system board

Next steps

1. Replace the following components:
 - a. [Trusted Platform Module \(TPM\)](#)
NOTE: The TPM Module must be replaced only while installing new system board.
 - b. [Mini PERC card](#)
 - c. [IDSDM module](#)
 - d. [Expansion cards](#)
 - e. [Expansion card risers](#)
 - f. [Processor](#)
 - g. [Heat sink](#)
 - h. [Memory modules](#)
 - i. [LOM riser card](#)
 - j. [Air shroud](#)
2. Reconnect all cables to the system board.
NOTE: Ensure that the cables inside the system are routed along the chassis wall and secured using the cable securing bracket.
3. Ensure that you perform the following steps:
 - a. Use the Easy Restore feature to restore the Service Tag. See the [Restoring the system by using the Easy Restore feature](#) section.
 - b. If the service tag is not backed up in the backup flash device, enter the system service tag manually. See the [Manually update the Service Tag by using System Setup](#) section.

- c. Update the BIOS and iDRAC versions.

Re-enable the Trusted Platform Module (TPM). See the [Upgrading the Trusted Platform Module](#) section.



4. If you are not using Easy restore, import your new or existing iDRAC Enterprise license. For more information, see the *Integrated Dell Remote Access Controller User's Guide* available at <https://www.dell.com/idracmanuals>.
5. Follow the procedure listed in [After working inside your system](#).

Restoring Service Tag using Easy Restore

The Easy Restore feature allows you to restore your Service Tag, iDRAC license, UEFI configuration, and the system configuration data after replacing the system board. All data is backed up in a backup Flash drive device automatically. If BIOS detects a new system board, and the Service Tag in the backup Flash drive device is different, BIOS prompts the user to restore the backup information.

About this task

Below is a list of options available:

1. Restore the Service Tag, license, and diagnostics information, press **Y**.
 2. Go to the Lifecycle Controller based restore options, press **N**.
 3. Restore data from a previously created **Hardware Server Profile**, press **F10**.
 **NOTE:** When the restore process is complete, BIOS prompts to restore the system configuration data.
 4. To restore the system configuration data, press **Y**
 5. To use the default configuration settings, press **N**
 **NOTE:** After the restore process is complete, system reboots.
-  **NOTE:** If restoring the Service Tag is successful, you can check the Service Tag information in the **System Information** screen and compare it with the Service Tag on the system.

Manually updating Service Tag

After replacing a system board, if Easy Restore fails, follow this process to manually enter the Service Tag, using **System Setup**.

About this task

If you know the system Service Tag, use the **System Setup** menu to enter the Service Tag.

Steps

1. Turn on the system.
2. To enter the **System Setup**, press **F2**.
3. Click **Service Tag Settings**.
4. Enter the Service Tag.
 **NOTE:** You can enter the Service Tag only when the **Service Tag** field is empty. Ensure that you enter the correct Service Tag. After the Service Tag is entered, it cannot be updated or changed.
5. Click **OK**.

Trusted Platform Module

Upgrading the Trusted Platform Module

Prerequisites

-  **NOTE:**
- Ensure that your operating system supports the version of the TPM module being installed.

- Ensure that you download and install the latest BIOS firmware on your system.
- Ensure that the BIOS is configured to enable UEFI boot mode.

About this task

CAUTION: Once the TPM plug-in module is installed, it is cryptographically bound to that specific system board. Any attempt to remove an installed TPM plug-in module breaks the cryptographic binding, the removed TPM cannot be reinstalled or installed on another system board.

Removing the TPM

Steps

1. Locate the TPM connector on the system board.
2. Press to hold the module down and remove the screw using the security Torx 8-bit shipped with the TPM module.
3. Slide the TPM module out from its connector.
4. Push the plastic rivet away from the TPM connector and rotate it 90° counterclockwise to release it from the system board.
5. Pull the plastic rivet out of its slot on the system board.

Installing the TPM

Steps

1. To install the TPM, align the edge connectors on the TPM with the slot on the TPM connector.
2. Insert the TPM into the TPM connector such that the plastic rivet aligns with the slot on the system board.
3. Press the plastic rivet until the rivet snaps into place.
4. Replace the screw that secures the TPM to the system board.

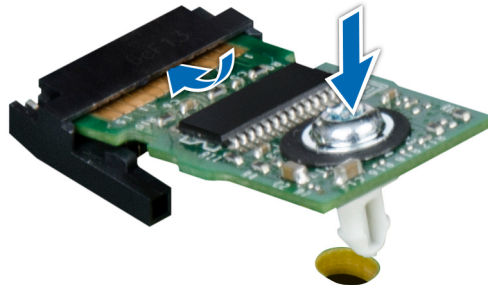

Figure 98. Installing the TPM

Initializing TPM for users

Steps

1. Initialize the TPM.
For more information, see [Initializing the TPM for users](#).
2. The **TPM Status** changes to **Enabled, Activated**.

Initializing the TPM 1.2 for users

Steps

1. While booting your system, press F2 to enter System Setup.
2. On the **System Setup Main Menu** screen, click **System BIOS > System Security Settings**.
3. From the **TPM Security** option, select **On with Preboot Measurements**.
4. From the **TPM Command** option, select **Activate**.
5. Save the settings.
6. Restart your system.

Initializing the TPM 2.0 for users

Steps

1. While booting your system, press F2 to enter System Setup.
2. On the **System Setup Main Menu** screen, click **System BIOS > System Security Settings**.
3. From the **TPM Security** option, select **On**.
4. Save the settings.
5. Restart your system.

Control panel

Removing the left control panel

Prerequisites

1. Follow the safety guidelines listed in the [Safety instructions](#).
2. Follow the procedure listed in the [Before working inside your system](#).
3. If applicable, [remove the backplane cover](#)
4. [Remove the air shroud](#).

Steps

1. Disconnect the control panel cable from the system board connector.

 **NOTE:** Observe the routing of the cable as you remove it from the system.

2. Using a Phillips #1 screwdriver, remove the screws that secure the cable cover to the system.
3. Using the Phillips #1 screwdriver, remove the screws that secure the left control panel assembly to the system.
4. Hold the left control panel assembly and remove it from the system.

 **NOTE:** The numbers on the image do not depict the exact steps. The numbers are for representation of sequence.

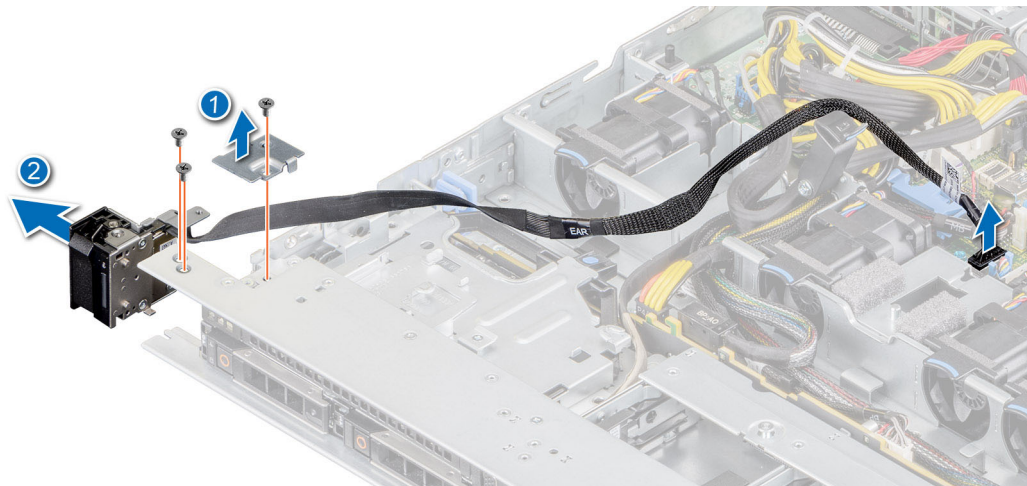

Figure 99. Removing the left control panel

Next steps

Replace the left control panel.

Installing the left control panel

Prerequisites

1. Follow the safety guidelines listed in the [Safety instructions](#).
2. Follow the procedure listed in the [Before working inside your system](#).

Steps

1. Route the control panel cable through the side wall and the guide slots in the system and connector on system board.

(i) NOTE: Route the cable properly to prevent the cable from being pinched or crimped.

2. Align and insert the left control panel assembly in the slot on the system.
3. Using the Phillips #1 screwdriver, tighten the screws that secure the left control panel assembly.
4. Using the Phillips #1 screwdriver, tighten the screws to secure the cable cover to the system.

(i) NOTE: The numbers on the image do not depict the exact steps. The numbers are for representation of sequence.

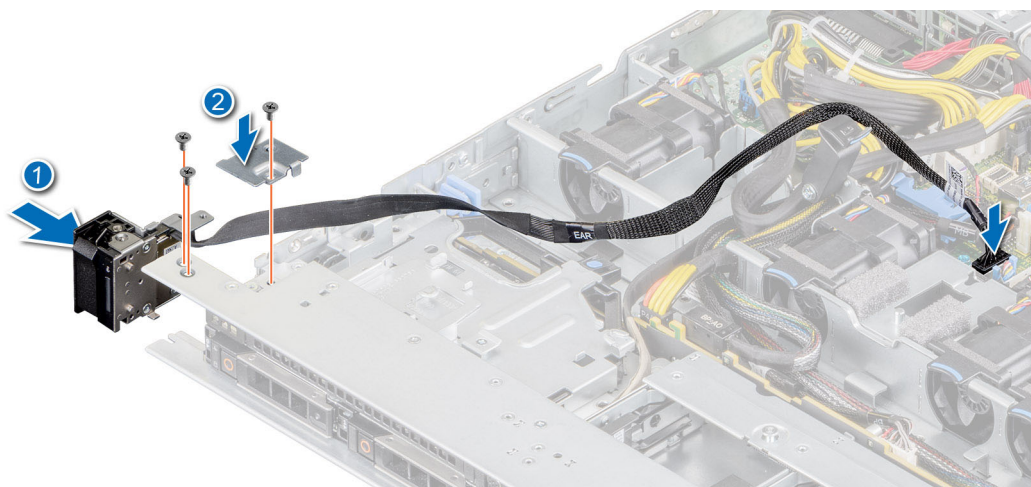

Figure 100. Installing the left control panel

Next steps

1. [Replace the air shroud.](#)
2. [Install the backplane cover](#)
3. Close and secure the cable guiding latch.
4. Follow the procedure listed in the [After working inside your system.](#)

Removing the right control panel

Prerequisites

1. Follow the safety guidelines listed in the [Safety instructions.](#)
2. Follow the procedure listed in the [Before working inside your system.](#)
3. If applicable, [remove the backplane cover](#)
4. [Remove the air shroud.](#)
5. Lift the cable guiding latch.

Steps

1. Using the Phillips #1 screwdriver, remove the screws that secure the cable cover and lift the cover away from the system.

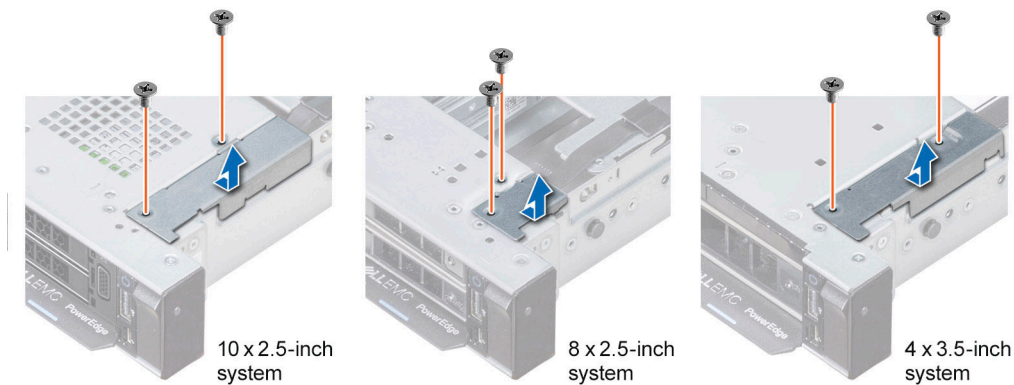

Figure 101. Removing the cable cover

2. Lift open the cable latch and disconnect the control panel cable from the connector on the system board.

NOTE: Observe the routing of the cable as you remove it from the system.

3. Using the Phillips #1 screwdriver, remove the screws that secure the right control panel assembly.
4. Hold the right control panel assembly and remove it from the system.

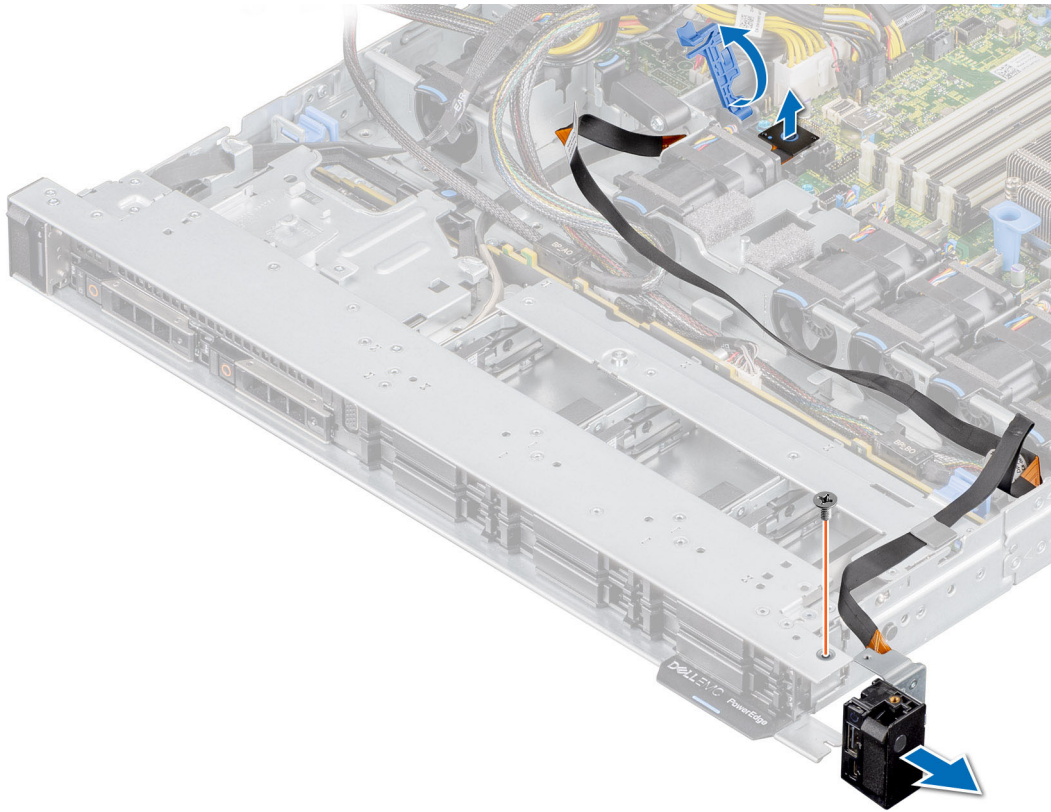

Figure 102. Removing the right control panel

Next steps

Replace the right control panel.

Installing the right control panel

Prerequisites

1. Follow the safety guidelines listed in the [Safety instructions](#).
2. Follow the procedure listed in the [Before working inside your system](#).

Steps

1. Route the control panel cable and VGA cable through the side wall of the system.

NOTE: Route the cable properly to prevent the cable from being pinched or crimped.

2. Align and insert the right control panel assembly in the slot on the system.
3. Connect the control panel cable to the connector system board and secure it using cable latch.
4. Using the Phillips #1 screwdriver, tighten the screws that secure the right control panel assembly.

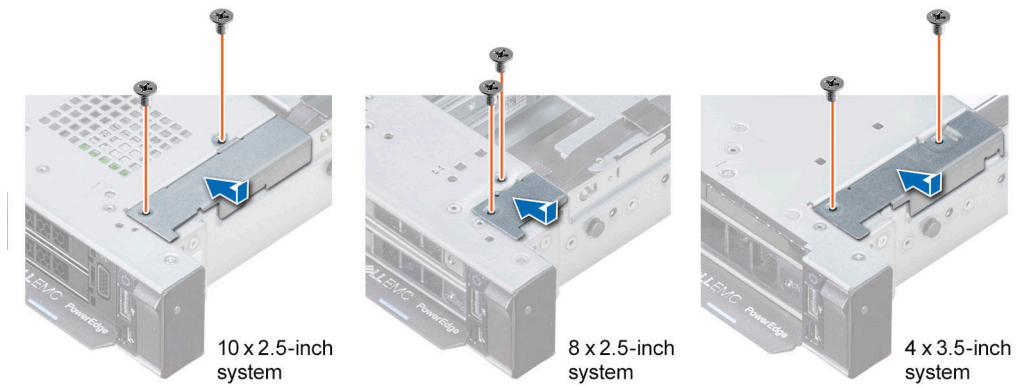

Figure 103. Installing the cable cover

5. Connect the control panel cable to the system board and secure it using cable latch.
6. Install the cable cover and secure it in place with screws, using a Phillips #1 screwdriver.

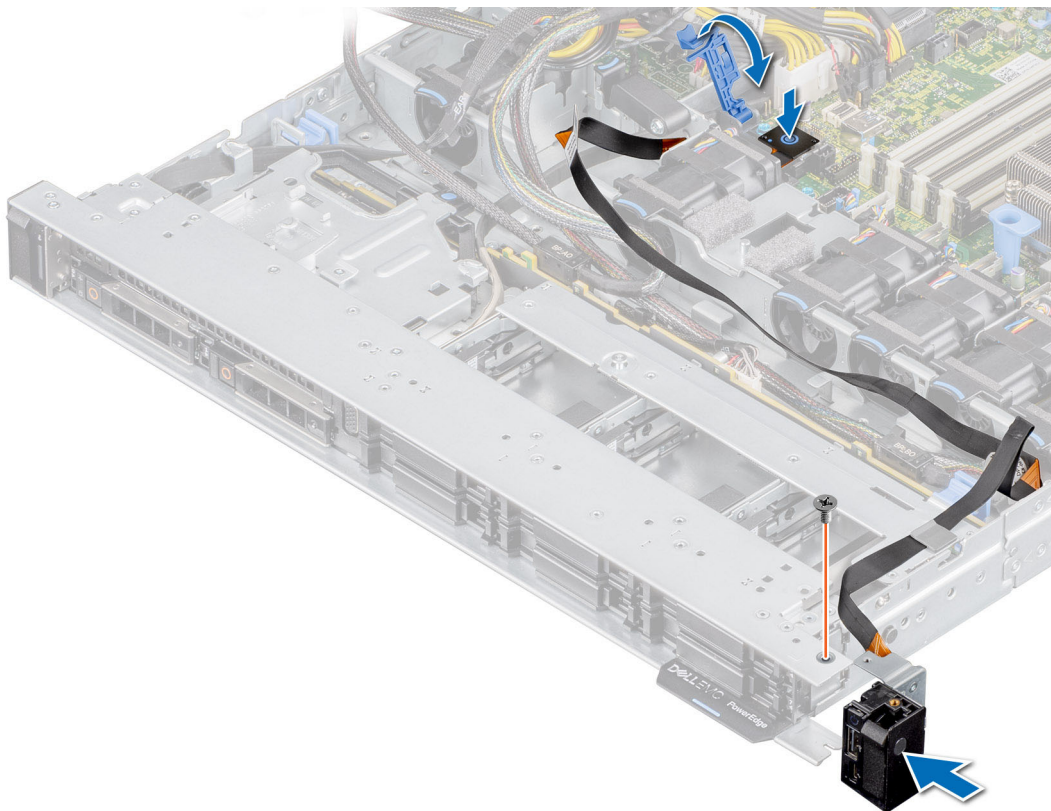

Figure 104. Installing the right control panel

Next steps

1. [Replace the air shroud.](#)
2. [Install the backplane cover](#)
3. Close and secure the cable guiding latch.
4. Follow the procedure listed in the [After working inside your system.](#)

Jumpers and connectors

This section provides essential and specific information about jumpers and switches. It also describes the connectors on the various boards in the system. Jumpers on the system board help to disable the system and reset the passwords. To install components and cables correctly, you must be able to identify the connectors on the system board.

Topics:

- [System board connectors](#)
- [System board jumper settings](#)
- [Disabling a forgotten password](#)

System board connectors

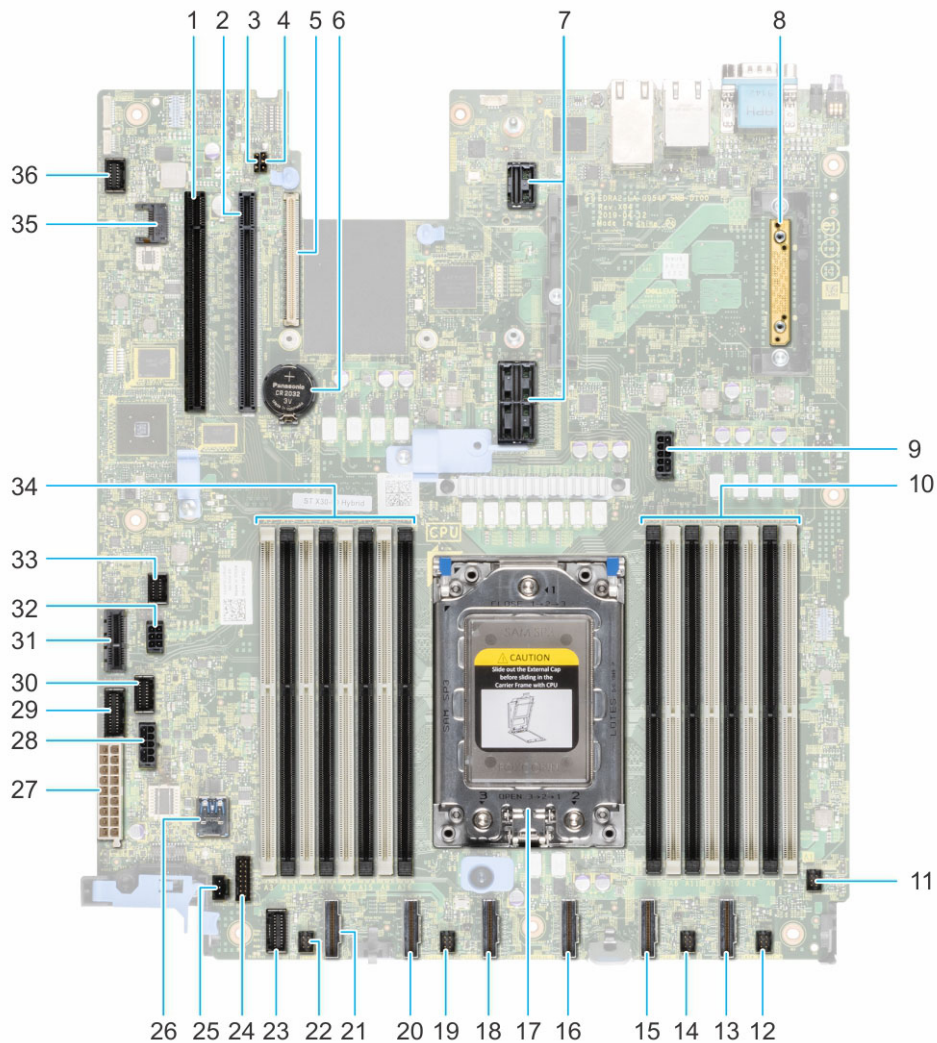

Figure 105. System board connectors

- | | |
|------------------------|-------------------------------|
| 1. PCI card Slot 5 | 2. PCI card Slot 4 |
| 3. PWRD_EN (Jumpers) | 4. NVRAM_CLR (Jumpers) |
| 5. LOM riser card | 6. Battery |
| 7. Riser slot 1A | 8. Mini PERC |
| 9. System power 3 | 10. DIMMS for processor |
| 11. Fan 6 | 12. Fan 5 |
| 13. SATA_A/PCIE_A | 14. Fan 4 |
| 15. PCIE-B | 16. SATA_B/PCIE_C |
| 17. Processor | 18. PCIE-D |
| 19. Fan 3 | 20. PCIE-E |
| 21. PCIE-F | 22. Fan 2 |
| 23. Left control panel | 24. Front backplane signal 1 |
| 25. Intrusion switch | 26. Internal USB 3.0 |
| 27. System power 1 | 28. System power 2 |
| 29. PIB signal 2 | 30. PIB signal 1 |
| 31. IDSDM | 32. Rear backplane/ ODD power |





33. Front backplane signal 0
35. TPM

34. DIMMS for processor
36. Front video

System board jumper settings

For information about resetting the password jumper to disable a password, see the [Disabling a forgotten password](#) section.

Table 21. System board jumper settings

Jumper	Setting	Description
PWRD_EN	 (default)	The BIOS password feature is enabled.
		The BIOS password feature is disabled. The BIOS password is now disabled and you are not allowed to set a new password.
NVRAM_CLR	 (default)	The BIOS configuration settings are retained at system boot.
		The BIOS configuration settings are cleared at system boot.

CAUTION: Be careful when changing the BIOS settings. The BIOS interface is designed for advanced users. Any change in the setting could prevent your system from starting correctly and you might have potential loss of data.

Disabling a forgotten password

The software security features of the system include a system password and a setup password. The password jumper enables or disables password features and clears any password(s) currently in use.

Prerequisites

CAUTION: Many repairs may only be done by a certified service technician. You should only perform troubleshooting and simple repairs as authorized in your product documentation, or as directed by the online or telephone service and support team. Damage due to servicing that is not authorized by Dell is not covered by your warranty. Read and follow the safety instructions that are shipped with your product.

Steps

1. Power off the system, and all the attached peripherals, and disconnect the system from the electrical outlet.
2. Remove the system cover.
3. Move the jumper on the system board from pins 2 and 4 to pins 4 and 6.
4. Replace the system cover.
 - NOTE:** The existing passwords are not disabled (erased) until the system boots with the jumper on pins 4 and 6. However, before you assign a new system and/or setup password, you must move the jumper back to pins 2 and 4.
 - NOTE:** If you assign a new system and/or setup password with the jumper on pins 4 and 6, the system disables the new password(s) the next time it boots.
5. Reconnect the system and all the attached peripherals.
6. Power off the system.
7. Remove the system cover.
8. Move the jumper on the system board from pins 4 and 6 to pins 2 and 4.
9. Replace the system cover.
10. Reconnect the system to the electrical outlet and power on the system, and all the attached peripherals.
11. Assign a new system and/or setup password.

System diagnostics and indicator codes

This section describes the diagnostic indicators on the system front panel that displays the system status during system startup.

Topics:

- Status LED indicators
- System health and system ID indicator codes
- iDRAC Quick Sync 2 indicator codes
- iDRAC Direct LED indicator codes
- LCD panel
- NIC indicator codes
- Power supply unit indicator codes
- Drive indicator codes
- Using system diagnostics

Status LED indicators

 **NOTE:** The indicators display solid amber if any error occurs.

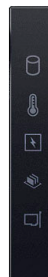

Figure 106. Status LED indicators

Table 22. Status LED indicators and descriptions





Icon	Description	Condition	Corrective action
	Drive indicator	The indicator turns solid amber if there is a drive error.	<ul style="list-style-type: none"> • Check the System Event Log to determine if the drive has an error. • Run the appropriate Online Diagnostics test. Restart the system and run embedded diagnostics (ePSA). • If the drives are configured in a RAID array, restart the system, and enter the host adapter configuration utility program.
	Temperature indicator	The indicator turns solid amber if the system experiences a thermal error (for example, the ambient temperature is out of range or there is a fan failure).	<p>Ensure that none of the following conditions exist:</p> <ul style="list-style-type: none"> • A cooling fan has been removed or has failed. • System cover, air shroud, or back filler bracket is removed. • Ambient temperature is too high. • External airflow is obstructed. <p>If the problem persists, see the Getting help section.</p>

Table 22. Status LED indicators and descriptions (continued)

Icon	Description	Condition	Corrective action
	Electrical indicator	The indicator turns solid amber if the system experiences an electrical error (for example, voltage out of range, or a failed power supply unit (PSU) or voltage regulator).	Check the System Event Log or system messages for the specific issue. If it is due to a problem with the PSU, check the LED on the PSU. Reseat the PSU. If the problem persists, see the Getting help section.
	Memory indicator	The indicator turns solid amber if a memory error occurs.	Check the System Event Log or system messages for the location of the failed memory. Reseat the memory module. If the problem persists, see the Getting help section.
	PCIe indicator	The indicator turns solid amber if a PCIe card experiences an error.	Restart the system. Update any required drivers for the PCIe card. Reinstall the card. If the problem persists, see the Getting help section. NOTE: For more information about the supported PCIe cards, see the Expansion card installation guidelines section.

System health and system ID indicator codes

The system health and system ID indicator is located on the left control panel of the system.



Figure 107. System health and system ID indicator

Table 23. System health and system ID indicator codes

System health and system ID indicator code	Condition
Solid blue	Indicates that the system is powered on, is healthy, and system ID mode is not active. Press the system health and system ID button to switch to system ID mode.
Blinking blue	Indicates that the system ID mode is active. Press the system health and system ID button to switch to system health mode.
Solid amber	Indicates that the system is in fail-safe mode. If the problem persists, see the Getting help section.
Blinking amber	Indicates that the system is experiencing a fault. Check the System Event Log for specific error messages. For information about the event and error messages generated by the system firmware and agents that monitor system components, go to qrl.dell.com > Look Up > Error Code , type the error code, and then click Look it up .

iDRAC Quick Sync 2 indicator codes

iDRAC Quick Sync 2 module (optional) is located on the left control panel of the system.



Table 24. iDRAC Quick Sync 2 indicators and descriptions

iDRAC Quick Sync 2 indicator code	Condition	Corrective action
Off (default state)	Indicates that the iDRAC Quick Sync 2 feature is powered off. Press the iDRAC Quick Sync 2 button to power on the iDRAC Quick Sync 2 feature.	If the LED fails to power on, reseal the left control panel flex cable and check. If the problem persists, see the Getting help section.
Solid white	Indicates that iDRAC Quick Sync 2 is ready to communicate. Press the iDRAC Quick Sync 2 button to power off.	If the LED fails to power off, restart the system. If the problem persists, see the Getting help section.
Blinks white rapidly	Indicates data transfer activity.	If the indicator continues to blink indefinitely, see the Getting help section.
Blinks white slowly	Indicates that firmware update is in progress.	If the indicator continues to blink indefinitely, see the Getting help section.
Blinks white five times rapidly and then powers off	Indicates that the iDRAC Quick Sync 2 feature is disabled.	Check if iDRAC Quick Sync 2 feature is configured to be disabled by iDRAC. If the problem persists, see the Getting help section. www.dell.com/poweredgemanuals or <i>Dell OpenManage Server Administrator User's Guide</i> at https://www.dell.com/openmanagemanuals .
Solid amber	Indicates that the system is in fail-safe mode.	Restart the system. If the problem persists, see the Getting help section.
Blinking amber	Indicates that the iDRAC Quick Sync 2 hardware is not responding properly.	Restart the system. If the problem persists, see the Getting help section.

iDRAC Direct LED indicator codes

The iDRAC Direct LED indicator lights up to indicate that the port is connected and is being used as a part of the iDRAC subsystem.

You can configure iDRAC Direct by using a USB to micro USB (type AB) cable, which you can connect to your laptop or tablet. Cable length should not exceed 3 feet (0.91 meters). Performance could be affected by cable quality. The following table describes iDRAC Direct activity when the iDRAC Direct port is active:

Table 25. iDRAC Direct LED indicator codes

iDRAC Direct LED indicator code	Condition
Solid green for two seconds	Indicates that the laptop or tablet is connected.
Blinking green (on for two seconds and off for two seconds)	Indicates that the laptop or tablet connected is recognized.
Powers off	Indicates that the laptop or tablet is unplugged.

LCD panel

The LCD panel provides system information, status, and error messages to indicate if the system is functioning correctly or requires attention. The LCD panel is used to configure or view the iDRAC IP address of the system. For information about the event and error messages generated by the system firmware and agents that monitor system components, go to qrl.dell.com > **Look Up** > **Error Code**, type the error code, and then click **Look it up**.

The LCD panel is available only on the optional front bezel. The optional front bezel is hot pluggable.

The status and conditions of the LCD panel are outlined here:

- The LCD backlight is white during normal operating conditions.
- If there is an issue, the LCD backlight turns amber and displays an error code followed by descriptive text.
 - ⓘ **NOTE:** If the system is connected to a power source and an error is detected, the LCD turns amber regardless of whether the system is powered on or off.
- When the system powers off and there are no errors, the LCD enters the standby mode after five minutes of inactivity. Press any button on the LCD to power it on.
- If the LCD panel stops responding, remove the bezel and reinstall it.
 - If the problem persists, see [Getting help](#).
- The LCD backlight remains off if LCD messaging is powered off using the iDRAC utility, the LCD panel, or other tools.

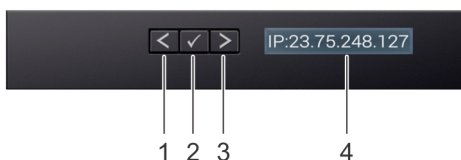

Figure 108. LCD panel features



Table 26. LCD panel features

Item	Button or display	Description
1	Left	Moves the cursor back in one-step increments.
2	Select	Selects the menu item highlighted by the cursor.
3	Right	Moves the cursor forward in one-step increments. During message scrolling: <ul style="list-style-type: none"> • Press and hold the right button to increase scrolling speed. • Release the button to stop. ⓘ NOTE: The display stops scrolling when the button is released. After 45 seconds of inactivity, the display starts scrolling.
4	LCD display	Displays the system information, status, and error messages or iDRAC IP address.

Viewing Home screen

The **Home** screen displays user-configurable information about the system. This screen is displayed during normal system operation when there are no status messages or errors. When the system turns off and there are no errors, LCD enters the standby mode after five minutes of inactivity. Press any button on the LCD to turn it on.

Steps

1. To view the **Home** screen, press one of the three navigation buttons (Select, Left, or Right).
2. To navigate to the **Home** screen from another menu, complete the following steps:
 - a. Press and hold the navigation button till the up arrow  is displayed.
 - b. Navigate to the **Home** icon  using the up arrow .

- c. Select the **Home** icon.
- d. On the **Home** screen, press the **Select** button to enter the main menu.

Setup menu

NOTE: When you select an option in the Setup menu, you must confirm the option before proceeding to the next action.

Table 27. Setup menu

Option	Description
iDRAC	Select DHCP or Static IP to configure the network mode. If Static IP is selected, the available fields are IP , Subnet (Sub) , and Gateway (Gtw) . Select Setup DNS to enable DNS and to view domain addresses. Two separate DNS entries are available.
Set error	Select SEL to view LCD error messages in a format that matches the IPMI description in the SEL. This enables you to match an LCD message with an SEL entry. Select Simple to view LCD error messages in a simplified user-friendly description. For information about the event and error messages generated by the system firmware and agents that monitor system components, go to qrl.dell.com > Look Up > Error Code , type the error code, and then click Look it up..
Set home	Select the default information to be displayed on the Home screen. See View menu section for the options and option items that can be set as the default on the Home screen.

View menu

NOTE: When you select an option in the View menu, you must confirm the option before proceeding to the next action.

Table 28. View menu

Option	Description
iDRAC IP	Displays the IPv4 or IPv6 addresses for iDRAC9. Addresses include DNS (Primary and Secondary) , Gateway , IP , and Subnet (IPv6 does not have Subnet).
MAC	Displays the MAC addresses for iDRAC , iSCSI , or Network devices.
Name	Displays the name of the Host , Model , or User String for the system.
Number	Displays the Asset tag or the Service tag for the system.
Power	Displays the power output of the system in BTU/hr or Watts. The display format can be configured in the Set home submenu of the Setup menu.
Temperature	Displays the temperature of the system in Celsius or Fahrenheit. The display format can be configured in the Set home submenu of the Setup menu.

NIC indicator codes

Each NIC on the back of the system has indicators that provide information about the activity and link status. The activity LED indicator indicates if data is flowing through the NIC, and the link LED indicator indicates the speed of the connected network.

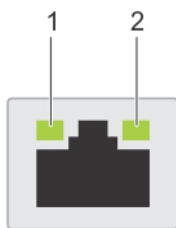

Figure 109. NIC indicator codes

1. Link LED indicator
2. Activity LED indicator

Table 29. NIC indicator codes

NIC indicator codes	Condition
Link and activity indicators are off.	Indicates that the NIC is not connected to the network.
Link indicator is green, and activity indicator is blinking green.	Indicates that the NIC is connected to a valid network at its maximum port speed, and data is being sent or received.
Link indicator is amber, and activity indicator is blinking green.	Indicates that the NIC is connected to a valid network at less than its maximum port speed, and data is being sent or received.
Link indicator is green, and activity indicator is off.	Indicates that the NIC is connected to a valid network at its maximum port speed, and data is not being sent or received.
Link indicator is amber, and activity indicator is off.	Indicates that the NIC is connected to a valid network at less than its maximum port speed, and data is not being sent or received.
Link indicator is blinking green, and activity is off.	Indicates that the NIC identify is enabled through the NIC configuration utility.

Power supply unit indicator codes

AC power supply units (PSUs) have an illuminated translucent handle that serves as an indicator. The indicator shows if power is present or if a power fault has occurred.



Figure 110. AC PSU status indicator

1. AC PSU status indicator/handle

Table 30. AC PSU status indicator codes

Power indicator codes	Condition
Green	Indicates that a valid power source is connected to the PSU and the PSU is operational.
Blinking amber	Indicates an issue with the PSU.
Not powered on	Indicates that the power is not connected to the PSU.

Table 30. AC PSU status indicator codes (continued)

Power indicator codes	Condition
Blinking green	Indicates that the firmware of the PSU is being updated. CAUTION: Do not disconnect the power cord or unplug the PSU when updating firmware. If firmware update is interrupted, the PSUs do not function.
Blinking green and powers off	When hot-plugging a PSU, it blinks green five times at a rate of 4 Hz and powers off. This indicates a PSU mismatch due to efficiency, feature set, health status, or supported voltage. CAUTION: If two PSUs are installed, both the PSUs must have the same type of label; for example, Extended Power Performance (EPP) label. Mixing PSUs from previous generations of PowerEdge servers is not supported, even if the PSUs have the same power rating. This results in a PSU mismatch condition or failure to power on the system. CAUTION: If two PSUs are used, they must be of the same type and have the same maximum output power. CAUTION: When correcting a PSU mismatch, replace the PSU with the blinking indicator. Swapping the PSU to make a matched pair can result in an error condition and an unexpected system shutdown. To change from a high output configuration to a low output configuration or vice versa, you must power off the system. CAUTION: AC PSUs support both 240 V and 120 V input voltages with the exception of Titanium PSUs, which support only 240 V. When two identical PSUs receive different input voltages, they can output different wattages, and trigger a mismatch.

Drive indicator codes

The LEDs on the drive carrier indicates the state of each drive. Each drive carrier has two LEDs: an activity LED (green) and a status LED (bicolor, green/amber). The activity LED blinks whenever the drive is accessed.



Figure 111. Drive indicators

1. Drive activity LED indicator
2. Drive status LED indicator
3. Drive capacity label

NOTE: If the drive is in the Advanced Host Controller Interface (AHCI) mode, the status LED indicator does not power on.

NOTE: Drive status indicator behavior is managed by Storage Spaces Direct. Not all drive status indicators may be used.

Table 31. Drive indicator codes

Drive status indicator code	Condition
Blinks green twice per second	Indicates that the drive is being identified or preparing for removal.
Off	Indicates that the drive is ready for removal. NOTE: The drive status indicator remains off until all drives are initialized after the system is powered on. Drives are not ready for removal during this time.

Table 31. Drive indicator codes (continued)

Drive status indicator code	Condition
Blinks green, amber, and then powers off	Indicates that there is an expected drive failure.
Blinks amber four times per second	Indicates that the drive has failed.
Blinks green slowly	Indicates that the drive is rebuilding.
Solid green	Indicates that the drive is online.
Blinks green for three seconds, amber for three seconds, and then powers off after six seconds	Indicates that the rebuild has stopped.

Using system diagnostics

If you experience an issue with the system, run the system diagnostics before contacting Dell for technical assistance. The purpose of running system diagnostics is to test the system hardware without using additional equipment or risking data loss. If you are unable to fix the issue yourself, service and support personnel can use the diagnostics results to help you solve the issue.

Dell Embedded System Diagnostics

 **NOTE:** The Dell Embedded System Diagnostics is also known as Enhanced Pre-boot System Assessment (ePSA) diagnostics.

The Embedded System Diagnostics provide a set of options for particular device groups or devices allowing you to:

- Run tests automatically or in an interactive mode
- Repeat tests
- Display or save test results
- Run thorough tests to introduce additional test options to provide extra information about the failed device(s)
- View status messages that inform you if tests are completed successfully
- View error messages that inform you of issues encountered during testing

Running the Embedded System Diagnostics from the Dell Lifecycle Controller

Steps

1. As the system boots, press F10.
2. Select **Hardware Diagnostics** → **Run Hardware Diagnostics**.
The **ePSA Pre-boot System Assessment** window is displayed, listing all devices detected in the system. The diagnostics starts executing the tests on all the detected devices.

Running the Embedded System Diagnostics from Boot Manager

Run the Embedded System Diagnostics (ePSA) if your system does not boot.

Steps

1. When the system is booting, press F11.
2. Use the up arrow and down arrow keys to select **System Utilities** > **Launch Diagnostics**.
3. Alternatively, when the system is booting, press F10, select **Hardware Diagnostics** > **Run Hardware Diagnostics**.
The **ePSA Pre-boot System Assessment** window is displayed, listing all devices detected in the system. The diagnostics starts executing the tests on all the detected devices.

Results

System diagnostic controls

Table 32. System diagnostic controls

Menu	Description
Configuration	Displays the configuration and status information of all detected devices.
Results	Displays the results of all tests that are run.
System health	Provides the current overview of the system performance.
Event log	Displays a time-stamped log of the results of all tests run on the system. This is displayed if at least one event description is recorded.

Getting help

Topics:

- [Recycling or End-of-Life service information](#)
- [Contacting Dell](#)
- [Accessing system information by using QRL](#)
- [Receiving automated support with SupportAssist](#)

Recycling or End-of-Life service information

Take back and recycling services are offered for this product in certain countries. If you want to dispose of system components, visit www.dell.com/recyclingworldwide and select the relevant country.

Contacting Dell

Dell provides online and telephone based support and service options. If you do not have an active internet connection, you can find Dell contact information on your purchase invoice, packing slip, bill or Dell product catalog. The availability of services varies depending on the country and product, and some services may not be available in your area. To contact Dell for sales, technical assistance, or customer service issues:

Steps

1. Go to www.dell.com/support/home.
2. Select your country from the drop-down menu on the lower right corner of the page.
3. For customized support:
 - a. Enter the system Service Tag in the **Enter a Service Tag, Serial Number, Service Request, Model, or Keyword** field.
 - b. Click **Submit**.
The support page that lists the various support categories is displayed.
4. For general support:
 - a. Select your product category.
 - b. Select your product segment.
 - c. Select your product.
The support page that lists the various support categories is displayed.
5. For contact details of Dell Global Technical Support:
 - a. Click [Contact Technical Support](#).
 - b. The **Contact Technical Support** page is displayed with details to call, chat, or e-mail the Dell Global Technical Support team.

Accessing system information by using QRL

You can use the Quick Resource Locator (QRL) located on the information tag in the front of the R6515 system, to access information about Dell EMC PowerEdge R6515. There is also another QRL for accessing product information located on the top of the system cover.

Prerequisites

Ensure that your smartphone or tablet has the QR code scanner installed.

The QRL includes the following information about your system:

- How-to videos
- Reference materials, including the Installation and Service Manual, LCD diagnostics, and mechanical overview
- The system service tag to quickly access the specific hardware configuration and warranty information
- A direct link to Dell to contact technical assistance and sales teams

Steps

1. Go to www.dell.com/qrl, and navigate to your specific product or
2. Use your smart phone or tablet to scan the model-specific Quick Resource (QR) code on your system or in the Quick Resource Locator section.

Quick Resource Locator for PowerEdge R6515 system



Figure 112. Quick Resource Locator for PowerEdge R6515 system

Receiving automated support with SupportAssist

Dell EMC SupportAssist is an optional Dell EMC Services offering that automates technical support for your Dell EMC server, storage, and networking devices. By installing and setting up a SupportAssist application in your IT environment, you can receive the following benefits:

- Automated issue detection — SupportAssist monitors your Dell EMC devices and automatically detects hardware issues, both proactively and predictively.
- Automated case creation — When an issue is detected, SupportAssist automatically opens a support case with Dell EMC Technical Support.
- Automated diagnostic collection — SupportAssist automatically collects system state information from your devices and uploads it securely to Dell EMC. This information is used by Dell EMC Technical Support to troubleshoot the issue.
- Proactive contact — A Dell EMC Technical Support agent contacts you about the support case and helps you resolve the issue.

The available benefits vary depending on the Dell EMC Service entitlement purchased for your device. For more information about SupportAssist, go to www.dell.com/supportassist.

Documentation resources

This section provides information about the documentation resources for your system.

To view the document that is listed in the documentation resources table:

- From the Dell EMC support site:
 1. Click the documentation link that is provided in the Location column in the table.
 2. Click the required product or product version.
-  **NOTE:** To locate the product name and model, see the front of your system.
- On the Product Support page, click **Manuals & documents**.
- Using search engines:
 - Type the name and version of the document in the search box.

Table 33. Additional documentation resources for your system

Task	Document	Location
Setting up your system	<p>For more information about installing and securing the system into a rack, see the Rail Installation Guide included with your rail solution.</p> <p>For information about setting up your system, see the <i>Getting Started Guide</i> document that is shipped with your system.</p>	www.dell.com/poweredgemanuals
Configuring your system	<p>For information about the iDRAC features, configuring and logging in to iDRAC, and managing your system remotely, see the Integrated Dell Remote Access Controller User's Guide.</p> <p>For information about understanding Remote Access Controller Admin (RACADM) subcommands and supported RACADM interfaces, see the RACADM CLI Guide for iDRAC.</p> <p>For information about Redfish and its protocol, supported schema, and Redfish Eventing implemented in iDRAC, see the Redfish API Guide.</p> <p>For information about iDRAC property database group and object descriptions, see the Attribute Registry Guide.</p> <p>For information about Intel QuickAssist Technology, see the Integrated Dell Remote Access Controller User's Guide.</p>	www.dell.com/poweredgemanuals

Table 33. Additional documentation resources for your system (continued)

Task	Document	Location
	<p>For information about earlier versions of the iDRAC documents.</p> <p>To identify the version of iDRAC available on your system, on the iDRAC web interface, click ? > About.</p>	<p>www.dell.com/idracmanuals</p>
	<p>For information about installing the operating system, see the operating system documentation.</p>	<p>www.dell.com/operatingsystemmanuals</p>
	<p>For information about updating drivers and firmware, see the Methods to download firmware and drivers section in this document.</p>	<p>www.dell.com/support/drivers</p>
<p>Managing your system</p>	<p>For information about systems management software offered by Dell, see the Dell OpenManage Systems Management Overview Guide.</p>	<p>www.dell.com/poweredgemanuals</p>
	<p>For information about setting up, using, and troubleshooting OpenManage, see the Dell OpenManage Server Administrator User's Guide.</p>	<p>www.dell.com/openmanagemanuals > OpenManage Server Administrator</p>
	<p>For information about installing and using Dell SupportAssist, see the Dell EMC SupportAssist Enterprise User's Guide.</p>	<p>https://www.dell.com/serviceabilitytools</p>
	<p>For information about partner programs enterprise systems management, see the OpenManage Connections Enterprise Systems Management documents.</p>	<p>www.dell.com/openmanagemanuals</p>
	<p>Understanding event and error messages</p>	<p>For information about the event and error messages generated by the system firmware and agents that monitor system components, go to qrl.dell.com > Look Up > Error Code, type the error code, and then click Look it up.</p>
<p>Troubleshooting your system</p>	<p>For information about identifying and troubleshooting the PowerEdge server issues, see the Server Troubleshooting Guide.</p>	<p>www.dell.com/poweredgemanuals</p>

www.dell.com/qrl